



Fischer Panda®

Power
wherever
you are™



Panda 15000i PMS

Super silent technology

230 V/400 V 50 Hz/60 Hz 15 kVA

120 V/240 V 50 Hz/60 Hz 15 kVA

Panda_15000i_System_eng.R06

4.5.16



	Document
Actual:	Panda_15000i_System_eng.R06_4.5.16
Replace:	Panda_15000i_System_eng.R05.2

Revision	Page
interne PEN Brücke PMGI	
PMGI mit Lade/Wechselrichtern (R04)	
iControl 2 berichtigt (Seeventil) R05	
400 V eingefügt R05.1	
60 Hz 230V eingefügt R05.2	
PMGI uni eingepflegt R06	

Erstellt durch / created by

Fischer Panda GmbH - Leiter Technische Dokumentation

Otto-Hahn-Str. 32-34

33104 Paderborn - Germany

Tel.: +49 (0) 5254-9202-0

email: info@fischerpanda.de

web: www.fischerpanda.de

Copyright

Duplication and change of the manual is permitted only in consultation with the manufacturer!

Fischer Panda GmbH, 33104 Paderborn, reserves all rights regarding text and graphics. Details are given to the best of our knowledge. No liability is accepted for correctness. Technical modifications for improving the product without previous notice may be undertaken without notice. Before installation, it must be ensured that the pictures, diagrams and related material are applicable to the genset supplied. Enquiries must be made in case of doubt.

Inhalt / Contents

Panda 15000i PMS.....	1
.....	2
1 General Instructions and Regulations	12
1.1 Safety first!.....	12
1.2 Tools.....	14
1.3 Manufacturer declaration in accordance with the Machinery Directive 2006/42/EC	16
1.4 Customer registration and guarantee	16
1.4.1 Technical support	16
1.4.2 Caution, important information for start-up!	16
1.5 Safety Instructions - Safety First!	17
1.5.1 Safe operation	17
1.5.2 Observe safety instructions!	17
1.5.3 Personal protective clothing (PPE)	17
1.5.4 Cleanliness ensures safety	17
1.5.5 Safe handling of fuels and lubricants	18
1.5.6 Exhaust fumes and fire protection	18
1.5.7 Safety precautions against burns and battery explosions	19
1.5.8 Protect your hands and body from rotating parts!	19
1.5.9 Anti-freeze and disposal of fluids	19
1.5.10 Implementation of safety inspections and maintenance	20
1.6 Warning and instruction signs.....	20
1.6.1 Special instructions and hazards of generators	20
1.6.1.1 Protective conductor and potential equalisation:.....	21
1.6.1.2 Protective conductor for Panda AC generators:.....	21
1.6.1.3 Switch off all loads while working on the generator	21
1.6.1.4 Potential equalisation for Panda AGT DC generators.....	21
1.6.1.5 Safety instructions concerning cables.....	22
1.6.2 General safety instructions for handling batteries	22
2 In case of Emergency First Aid / Im Notfall - Erste Hilfe	23
2.7 WHEN AN ADULT STOPS BREATHING	24
3 Basics	25
3.1 Intended use of the machine	25
3.2 Purpose of the manual and description of the definitions of the trained persons/operators/users	25
3.2.1 Trained persons	25
3.2.2 Operator/Owner	25
3.2.3 User	26
3.3 Components of the i-system.....	26
3.4 Panda transport box	27
3.4.1 Bolted Fischer Panda transport box	27
3.4.2 Fischer Panda transport box with metal tab closure	28
3.5 Opening the MPL sound insulation capsule	28
3.5.1 Opening the GFK sound insulation capsule	29
3.6 Transport and loading/unloading	30
3.6.1 Transporting the generator	30
3.6.2 Loading/unloading of the generator	30
3.7 Special service instructions and measures for extended machine downtimes and decommissioning	30

Inhalt / Contents

3.7.1	Instructions for the starter battery for extended downtimes	31
3.7.2	Measures for short downtimes	31
3.7.3	Measures for medium term downtimes / hibernation	31
3.7.3.1	Courses for preservation:	32
3.7.3.2	Measures for removing surface protection after medium term downtimes (3 to 6 months). 32	
3.7.4	Measures for extended downtimes / decommissioning	33
3.7.4.1	Courses for preservation:	33
3.7.4.2	Measures for removing surface protection after extended downtimes / recommissioning (over 6 months): 33	
4	Panda 15000i PMS generator	35
4.1	Type plate at the generator	35
4.2	Description of the generator.....	36
4.2.1	Right side view	36
4.2.2	Left side view	37
4.2.3	Front view	38
4.2.4	Back view	39
4.2.5	View from above	40
4.3	Details of function units.....	41
4.3.1	Remote control panel - See Panda iControl manual	41
4.3.2	Components of the cooling system (raw- and freshwater)	41
4.3.3	Components of the fuel, air intake and exhaust system	42
4.3.4	Components of the electrical system	43
4.3.5	Components of the lubrication system	44
4.3.6	Sensors and switches for operating surveillance	45
4.4	Operation instructions - See Panda iControl panel manual	46
4.4.1	Daily routine checks before starting - See Panda iControl manual	46
4.4.2	Starting generator - See Panda iControl manual	46
4.4.3	Stopping the generator - See Panda iControl manual	46
5	Installation Instructions.....	47
5.1	Personal requirements.....	47
5.1.1	Hazard notes for the installation	47
5.2	Place of installation	49
5.2.1	Preliminary remark	49
5.2.2	Preparing the base - placement	49
5.2.3	Advice for optimal sound insulation	50
5.3	Generator Connections.....	50
5.4	Installation of the cooling system - raw water	51
5.4.1	General information	51
5.4.2	Installation of the through hull fitting in Yachts - scheme	51
5.4.3	Quality of the raw water sucking in line	51
5.4.4	Generator installation above waterline	52
5.4.5	Generator installation below waterline	52
5.4.5.1	Raw water installation scheme.....	54
5.5	Installation of the cooling system - fresh water.....	55
5.5.1	Position of the external cooling water expansion tank	55
5.6	Installation of the water cooled exhaust system	56
5.6.1	Installation of the standard exhaust system	56

Inhalt / Contents

5.7	.Installation of the waterlock	56
5.7.1	Possible cause for water in the exhaust hose	57
	5.7.1.1 Possible cause: exhaust hose.....	57
	5.7.1.2 Possible cause: cooling water hose	57
5.7.2	Installation area of the waterlock	57
5.7.3	The volume of the waterlock	58
	5.7.3.1 Ideal position of the waterlock.....	58
	5.7.3.2 Example of the installation of the waterlock off-center and possible effects: ...	60
5.8	Exhaust / water separator	62
5.9	Installation exhaust water separator	62
5.10	Fuel system installation	63
5.10.1	Connection of the fuel lines at the tank	64
5.10.2	Position of the pre-filter with water separator	64
5.11	Generator DC system installation	65
5.11.1	Connection of the starter battery block	65
5.11.2	Connection of the remote control panel - See Panda iControl panel manual	68
5.12	Generator AC system installation	68
5.12.1	Installation PMGi inverter - See separate PMGi inverter manual	69
6	Generator operation instruction	71
6.1	Personal requirements.....	71
6.2	Hazard notes for the operation	71
6.3	General operating instruction.....	71
6.3.1	Operation at low temperatures	71
	6.3.1.1 Pre-heating the diesel motor	72
	6.3.1.2 Tips regarding starter battery	72
6.3.2	Light load operation and engine idle	72
	6.3.2.1 The soot of the generator is due to the fact that:	72
	6.3.2.2 To prevent the soot of the generator following steps should be observed:.....	72
6.3.3	Generator load for a longer period and overload	72
6.3.4	Protection conductor:	73
6.3.5	Operating control system on the Fischer Panda generator	73
6.4	Instructions for capacitors - not present at all models	73
6.5	Checks before start, starting and stopping the generator	73
6.6	Optional Electromagnetic Clutch	74
7	Maintenance Instructions.....	75
7.1	Personal requirements.....	75
7.2	Hazard notes for the maintenance and failure.....	75
7.3	Environmental protection	77
7.4	Maintenance Requirements	77
7.5	Maintenance interval.....	77
7.5.1	Check of hoses and rubber parts in the sound insulated capsule	77
7.6	Checking oil-level.....	77
7.6.1	Refilling oil	79
7.6.2	After the oil level check and refilling the oil	79
7.7	Replacement of engine oil and engine oil filter	80
7.7.1	After the oil change	82

Inhalt / Contents

7.8	Verifying the starter battery and (if necessary) the battery bank.....	83
7.8.1	Battery	83
7.8.1.1	Check battery and cable connections	83
7.8.1.2	Check electrolyte level	83
7.8.1.3	Check electrolyte density	84
7.9	Ventilating the fuel system	84
7.9.1	Replacement of the fuel filter	86
7.9.1.1	Optional fuel filter with sight glass	86
7.10	Checking the water separator in the fuel supply	87
7.11	Replacing the V-belt at Kubota 02/03/05 series.....	88
7.11.1	Replace the air filter mat	89
7.11.2	Alternative replacement of the air filter mat with pull out holder	90
7.11.3	Alternative replacement of the air filter at housing with snap fasteners	92
7.11.4	First filling and ventilation of the internal cooling water circuit	93
7.11.4.1	Anti-freeze in the cooling water circuit.....	94
7.11.5	Temperature check for controlling the cooling water circuit	94
7.11.6	The Raw water circuit	95
7.12	The raw water circuit.....	95
7.12.1	Clean raw water filter	95
7.13	Causes with frequent impeller waste	95
7.13.1	Replacement of the impeller	97
8	Generator Failure	99
8.1	Personal requirements.....	99
8.2	Safety instructions for this chapter	99
8.3	Tools and measuring instruments.....	101
8.4	Overloading the generator	101
8.4.1	Low generator-output voltage	102
8.5	Starting problems.....	102
8.6	Starting Problems	102
8.6.1	Fuel Solenoid Valve (optional)	102
8.6.2	Failure Bypass Switch	102
8.6.3	Stop solenoid	103
8.7	Troubleshooting table	104
9	Tables.....	105
9.1	Troubleshooting	105
9.2	Technical data.....	107
9.2.1	Technical Data Engine	107
9.3	Technical data.....	107
9.4	Diameter of conduits	108
9.5	Cable cross section.....	109
9.6	Engine oil	109
9.6.1	Engine oil classification	109
9.6.1.1	Operating range:	109
9.6.1.2	Quality of oil:.....	109
9.7	Coolant specifications	110
9.7.1	Coolant mixture ratio	111

Inhalt / Contens

9.8	Fuel.....	111
9.9	111
10	Inverter Panda PMGi.....	113
10.1	Safety instruction	114
10.2	Type plate.....	114
10.3	Front side/connection side PMGi 230 V - representative picture.....	115
10.4	Alternative front side/connection side PMGi 400 V - representative picture.....	115
10.5	Alternative front side/connection side PMGi 120 V/240 V - representative picture	116
10.5.1	Socket pins of the PMGi	116
10.5.1.1	PMGi AC out.....	116
10.5.1.2	PMGi input	117
10.5.1.3	Control.....	118
10.5.1.4	External PE/N Bridge	118
10.6	Back side - Top side	119
10.7	Settings for the use of iGenerators with power inverter	120
10.7.1	Settings in the Victron VE Configure II Software - General	120
10.7.1.1	Uninterrupted AC power (UPS function)	120
10.7.1.2	Dynamic current limiter	120
10.7.2	Settings in the Victron VE Configure II Software - Inverter	121
10.7.2.1	Assist current boost factor.....	121
10.8	Operation manual	122
10.8.1	Primary remarks / Winter operation	122
10.8.2	Load at the PMGi	122
10.8.3	Automatic start	122
10.9	Status LEDs.....	122
10.10	Cooling of the PMGi.....	122
10.11	Installation of the PMGi	123
10.11.1	Cooling water connection schema - Vehicle Generator	123
10.11.1.1	Integration of a water cooled PMGi inverter into the cooling system.	123
10.11.1.2	Cooling water scheme if the Radiator is higher than the Generator /Inverter ...	124
10.11.1.3	Cooling water scheme if the Radiator is on the same level or lower than the Generator /Inverter	124
10.11.1.4	Cooling water scheme for PVK-UK iGenerators	125
10.11.1.5	Cooling water connection schema - Marine (PMS) Generator.....	126
10.11.2	Electrical connection.	127
10.11.2.1	Connection to a system with RCD at PMGi with PEN jumper.....	127
10.11.2.2	Connection to a system with RCD at PMGi without PEN jumper.....	127
10.11.2.3	Connection to a system with isolation control at PMGi with PEN jumper	128
10.11.2.4	Connection to a system with isolation control at PMGi without PEN jumper ...	128
10.12	Technical Data.....	128
10.12.1	General Data	128
10.12.2	Generator Specification	128
10.12.3	PMGi out	129
10.13	PMGi protections	135
10.13.1	Short circuit	135
	Panda iControl2.....	137
	Current revision status.....	138

Inhalt / Contents

Hardware	138
11 Safety instructions for the Panda iControl2	139
11.1 Personnel.....	139
11.2 Safety instructions.....	139
12 General operation	141
12.1 The Panda iControl2 panel.....	141
12.2 Starting preparation / Checks (daily).....	142
12.2.1 Marine version.....	142
12.2.2 Vehicle version.....	142
12.3 Operation.....	143
12.3.1 Switching the controller on and off.....	143
12.3.2 The default display screen.....	143
12.3.3 Operating modes.....	144
12.3.3.1 Stand-by mode.....	144
12.3.3.2 Start-up mode.....	145
12.3.3.3 Override mode.....	146
12.3.3.4 Operation mode.....	146
12.3.3.5 Panda i-Generator with electro-magnet Clutch (optional).....	148
12.3.3.6 Stop mode.....	149
12.3.3.7 Autostart mode.....	149
12.4 Other operating functions.....	151
12.4.1 Set-up menu.....	151
12.4.2 Setting the brightness of the backlight ("backlight" and "dimtime").....	152
12.4.3 The configuration menu ("config").....	153
12.4.4 The network ID.....	153
12.4.5 Saving settings and exiting the set-up menu ("Save & Exit").....	153
12.4.6 Activating/deactivating the autostart function ("Autostart").....	153
12.4.7 Resetting the service interval ("Service").....	155
12.4.8 Priming the fuel system ("Prime Fuel").....	156
12.4.9 Selecting and saving a unit for the temperature value output.....	156
12.5 iControl2-Emergency-Stop.....	156
13 Installation	159
13.1 Personnel.....	159
13.1.1 Hazard warnings for installation.....	159
13.2 Disposal of the components.....	160
13.2.1 Panda iControl2 panel with installation housing.....	161
13.2.2 Terminal assignments on the Panda iControl2 panel.....	161
13.3 Dimensions.....	162
13.4 Wiring of the Panda iControl2 controller.....	163
13.4.1 Terminal assignments on the Panda iControl2 controller.....	164
13.4.1.1 Terminal assignment of 18-pin connector.....	164
13.4.1.2 Fischer Panda standard bus.....	164
13.4.1.3 Fischer Panda CAN bus.....	164
13.5 Master and Slave Panels.....	165
13.6 Start-up.....	165
14 Maintenance	167
14.1 Maintenance of the iControl2 controller.....	167

Inhalt / Contens

14.1.1	Cleaning the iControl2 controller	167
14.2	Maintenance of the iControl2 remote control panel	167
14.2.1	Cleaning the iControl2 controller	167
15	Warnings and error messages	169
15.1	Warnings.....	169
15.1.1	Examples of warnings on the display:	169
15.1.2	Warning messages	170
15.2	Faults	170
15.2.1	Error messages	171
15.2.2	Warning and fault thresholds	171
15.2.3	Bus errors	172
15.3	The error memory of the iControl 2 Panel	172
15.3.1	How to get to the error memory of the iControl2 Panel?	173
15.3.2	How are stored errors displayed?	173
15.3.3	How do I exit the error memory after having read the entries?	173
15.3.4	Can I delete the error memory?	173
15.3.5	Where are the errors stored?	173
15.3.6	In which language are the stored errors displayed?	173
15.3.7	Is it possible to upgrade an old iGenerator model by the error memory?	174
16	Annex	175
16.1	Technical data	175
16.1.1	Technical data for iControl2 control unit	175
16.1.2	Technical data for iControl2 remote control panel	175

Leere Seite / Intentionally blank

Dear Customer,

Thank you for purchasing a Fischer Panda Generator and choosing Fischer Panda as your partner for mobile power on board. With your generator, you now have the means to produce your own power – wherever you are - and experience even greater independence. Not only do you have a Fischer Panda generator on board, you also have worldwide support from the Fischer Panda Team. Please take the time to read this and find how we can support you further.

Installation Approval and Warranty

Every generator has a worldwide warranty. You can apply for this warranty through your dealer when the installation is approved. If you have purchased an extended warranty, please ensure that it is kept in a safe place and that the dealer has your current address. Consult your dealer about warranty options especially if you have purchased a used generator. He will be able to advise about authorised Fischer Panda Services worldwide.

Service and Support

To ensure that your generator operates reliably, regular maintenance checks and tasks as specified in this manual must be carried out. Fischer Panda can supply Service Kits which are ideal for regular servicing tasks. We only supply the highest quality components which are guaranteed to be the RIGHT parts for your generator. Service “Plus” Kits are also available and ideal for longer trips where more than one service interval may be required.

If you require assistance – please contact your Fischer Panda Dealer. Please do not attempt to undertake any repair work yourself, as this may affect your generator warranty. Your dealer will also be able to assist in finding your nearest Fischer Panda service station. Your nearest service station can also be found in our Global Service Network which can be downloaded from our homepage.

Product Registration

Please take the time to register your Fischer Panda Generator on our website at

<http://www.fischerpanda.de/mypanda>

By registering, you will ensure that you will be kept up to date on any technical upgrades or specific information on the operation or servicing of your generator. We can even let you know about new Fischer Panda products – especially helpful if you are planning to upgrade or expand your installation at a later date.

Fischer Panda Quality - Tried and Tested

DIN-certified according DIN ISO 9001

Thank you for purchasing a Fischer Panda Generator.

Your Fischer Panda Team

1. General Instructions and Regulations

1.1 Safety first!

These symbols are used throughout this manual and on labels on the machine itself to warn of the possibility of personal injury or lethal danger during certain maintenance work or operations. Read these instructions carefully.

Can cause acute or chronic health impairments or death even in very small quantities if inhaled, swallowed, or absorbed through the skin.

WARNING: Hazardous materials



This warning symbol draws attention to special warnings, instructions or procedures which, if not strictly observed, may result in damage or destruction of equipment.

WARNING: Important information!



Warning of materials that may ignite in the presence of an ignition source (cigarettes, hot surfaces, sparks, etc.).

WARNING: Fire hazard



In the environment described / during the work specified, smoking is prohibited.

PROHIBITED: No smoking



Fire and naked light are ignition sources that must be avoided.

PROHIBITED: No fire or naked light



The equipment shall not be activated or started up while work is in progress.

PROHIBITED: Do not activate/start up



Touching of the corresponding parts and systems is prohibited.

PROHIBITED: Do not touch



Danger for life! Working at a running generator can result in severe personal injury.

DANGER: Automatic start-up



The generator can be equipped with a automatic start device. This means, an external signal may trigger an automatic start-up. To avoid an unexpected starting of the generator, the starter battery must be disconnected before working at the generator.

This danger symbol refers to the danger of electric shock and draws attention to special warnings, instructions or procedures which, if not strictly observed, may result in severe personal injury or loss of life due to electric shock.

WARNING: Hazardous electric voltage



General warning of a hazard area

WARNING: General warning



Can cause acute or chronic health impairments or death even in very small quantities if inhaled or ingested.

WARNING: Danger due to inhalation and/or ingestion



Warning of live parts that may cause electric shock upon contact. Especially dangerous for persons with heart problems or pacemakers.

WARNING: Risk of electric shock upon contact



Danger of injury due to being pulled into equipment. Bruising and torn off body parts possible. Risk of being pulled in when touching with body part, loose-fitting clothing, scarf, tie, etc.

WARNING: Danger due to rotating parts



Warning of substances that may cause an explosion under certain conditions, e.g. presence of heat or ignition sources.

WARNING: Explosion hazard



Warning of hot surfaces and liquids. Burn/scalding hazard.

WARNING: Hot surface



Warning of substances that cause chemical burns upon contact. These substances can act as contaminants if introduced into the body.

WARNING: Danger due to corrosive substances, potential contamination of person



When the system is opened, the pressure can be relieved abruptly and expel hot gases and fluids. Risk of injury due to parts flying about, burn hazard due to liquids and gases.

WARNING: System may be pressurised!



Warning of hearing damages.

WARNING: Hearing damage



Warning of magnetic field.

WARNING: Magnetic field



Warning of overpressure.

WARNING: Overpressure



Wearing the applicable snugly fitting protective clothing provides protection from hazards and can prevent damage to your health.

MANDATORY INSTRUCTION: Wear snugly fitting protective clothing (PPE).



Wearing hearing protection provides protection from acute and gradual hearing loss.

MANDATORY INSTRUCTION: Wear hearing protection (PPE).



Wearing safety goggles protects the eyes from damage. Optical spectacles are not a replacement for the corresponding safety goggles.

MANDATORY INSTRUCTION: Wear safety goggles (PPE).



Wearing protective gloves provides the hands from hazards like friction, graze, punctures or deep cuts and protects them from contact with hot surfaces.

MANDATORY INSTRUCTION: Wear protective gloves (PPE).



Compliance with the instructions in the manual can avert danger and prevent accidents. This will protect you and the generator.

MANDATORY INSTRUCTION: Observe the instructions in the manual.







Environmental protection saves our living environment. For you and for your children.





MANDATORY INSTRUCTION: Comply with environmental protection requirements.



1.2 Tools

These symbols are used throughout this manual to show which tool must be used for maintenance or installation.

	Spanners W.A.F X = width across flats of X mm
	Hook wrench for oil filter
	Screw driver, for slotted head screws and for Phillips head screws
	Multimeter, multimeter with capacitor measuring unit

	<p>Socket wrench set</p>
	<p>Hexagon socket wrench set</p>
	<p>Clamp-on ammeter (DC for synchronous generators; AC for asynchronous generators)</p>
	<p>Torque wrench</p>

1.3 Manufacturer declaration in accordance with the Machinery Directive 2006/42/EC

Manufacturer declaration in accordance with the Machinery Directive 2006/42/EC

The generator was designed in such a way that all assemblies correspond with the CE guidelines. If Machinery Directive 2006/42/EC is applied, then it is forbidden to start the generator until it has been ascertained that the system into which the generator is to be integrated also complies with the Machinery Directive 2006/42/EC. This includes the exhaust system, cooling system and electrical installations.

The evaluation of "protection against contact" must be carried out when installed, in conjunction with the respective system. This also includes correct electrical connections, a safe ground wire connection, foreign body and humidity protection, protection against moisture due to excessive condensation, as well as overheating through appropriate and inappropriate use of the equipment in its installed state. The responsibility for implementing these measures lies with those who undertake the installation of the generator in the final system.

1.4 Customer registration and guarantee

Use the advantages of registering your product:

- you will receive a Guarantee Certificate after approval of your installation data
- you will receive extended product information that may be relevant to safety.
- You will receive free upgrades as necessary.

Additional advantages:

Based on your complete data record, Fischer Panda technicians can provide you with fast assistance, since 90 % of the disturbances result from defects in the periphery.

Problems due to installation errors can be recognized in advance.

1.4.1 Technical support

Technical Support via the Internet: info@fischerpanda.de

1.4.2 Caution, important information for start-up!

1. The commissioning log shall be filled in immediately after initial operation and shall be confirmed by signature.
2. The commissioning log must be received by Fischer Panda GmbH at Paderborn within 4 weeks of initial operation.
3. After receiving the commissioning log, Fischer Panda will make out the official guarantee certificate and send it to the customer.
4. If warranty claims are made, the document with the guarantee certification must be submitted.

If the above requirements are not or only partly fulfilled, the warranty claim shall become void.

1.5 Safety Instructions - Safety First!

1.5.1 Safe operation

Careful handling of the equipment is the best insurance against an accident. Read the manual diligently, and make sure you understand it before starting up the equipment. All operators, regardless of their experience level, shall read this manual and additional pertinent manuals before commissioning the equipment or installing an attachment. The owner shall be responsible for ensuring that all operators receive this information and are instructed on safe handling practices.



1.5.2 Observe safety instructions!

Read and understand this manual and the safety instructions on the generator before trying to start up and operate the generator. Learn the operating practices and ensure work safety. Familiarise yourself with the equipment and its limits. Keep the generator in good condition.

1.5.3 Personal protective clothing (PPE)

For maintenance and repair work on the equipment, **do not** wear loose, torn, or ill-fitting clothing that may catch on protruding parts or come into contact with pulleys, cooling disks, or other rotating parts, which can cause severe injury.



Wear appropriate safety and protective clothing during work.

Do not operate the generator while under the influence of alcohol, medications, or drugs.



Do not wear head phones or ear buds while operating, servicing, or repairing the equipment.



1.5.4 Cleanliness ensures safety

Keep the generator and its environment clean.

Before cleaning the generator, shut down the equipment and secure it against accidental start-up. Keep the generator free from dirt, grease, and waste. Store flammable liquids in suitable containers only and ensure adequate distance to the generator. Check the lines regularly for leakage and eliminate leaks immediately as applicable.



1.5.5 Safe handling of fuels and lubricants

Keep fuels and lubricants away from naked fire.

Before filling up the tank and/or applying lubricant, always shut down the generator and secure it against accidental start-up.



Do not smoke and avoid naked flame and sparking near fuels and the generator. Fuel is highly flammable and may explode under certain conditions.

Refuel in well-ventilated open spaces only. If fuel/lubricant was spilled, eliminate fluids immediately.

Do not mix diesel fuel with petrol or alcohol. Such a mixture can cause fire and will damage the generator.



Use only approved fuel containers and tank systems. Old bottles and canisters are not adequate.

1.5.6 Exhaust fumes and fire protection

Engine fumes can be hazardous to your health if they accumulate. Ensure that the generator exhaust fumes are vented appropriately (leak-proof system), and that an adequate fresh air supply is available for the generator and the operator (forced ventilation).



Check the system regularly for leakage and eliminate leaks as applicable.

Exhaust gases and parts containing such fumes are very hot; they may cause burns under certain circumstances. Always keep flammable parts away from the generator and the exhaust system.

To prevent fire, ensure that electrical connections are not short-circuited. Check regularly that all lines and cables are in good condition and that there is no chafing. Bare wires, open chafing spots, frayed insulation, and loose cable connections can cause dangerous electric shocks, short-circuit, and fire.



The generator shall be integrated in the existing fire safety system by the operating company.

CALIFORNIA

Proposition 65 Warning

Diesel engine exhaust and some of its constituents are known to the State of California to cause cancer, birth defects, and other reproductive harm.



1.5.7 Safety precautions against burns and battery explosions

The generator and its cooling agents and lubricants as well as the fuel can get hot while the generator is operated. Use caution around hot components such as parts containing exhaust fumes, radiator, hoses, and engine block during operation and after the generator was shut down.



The cooling system may be pressurised. Open the cooling system only after letting the engine and the coolant cool down. Wear appropriate protective clothing (e.g. safety goggles, gloves).



Prior to operation, ensure that the cooling system is sealed and that all hose clamps are tightened.

The battery represents an explosion hazard, this applies both to the starter battery and the battery bank of the AGT generators. While batteries are being charged, a hydrogen-oxygen mixture is generated, which is highly explosive (electrolytic gas).



Do not use or charge batteries if the fluid level is below the MINIMUM marking. The life span of the battery is significantly reduced, and the risk of explosion increases. Refill to a fluid level between maximum and minimum level without delay.

Especially during charging, keep sparks and naked fire away from the batteries. Ensure that the battery terminals are tightly connected and not corroded to avoid sparking. Use an appropriate terminal grease.



Check the charge level with an adequate voltmeter or acid siphon. Contact of a metal object across the terminals will result in short-circuiting, battery damage, and high explosion risk.

Do not charge frozen batteries. Heat the batteries to +16 °C (61 °F) prior to charging.

1.5.8 Protect your hands and body from rotating parts!

Always keep the capsule closed while operating the generator.

To check the V-belt tension, always shut down the generator.

Keep your hands and body away from rotating parts such as V-belt, fans, pulleys, and flywheel. Contact can cause severe injury.



Do not run the engine without the safety devices in place. Prior to start-up, mount all safety devices securely and check for proper attachment and function.

1.5.9 Anti-freeze and disposal of fluids

Anti-freeze contains toxic substances. To prevent injury, wear rubber gloves and wash off any anti-freeze immediately in case of skin contact. Do not mix different anti-freeze agents. The mixture may cause a chemical reaction generating harmful substances. Use only anti-freeze that was approved by Fischer Panda.



Protect the environment. Collect drained fluids (lubricants, anti-freeze, fuel), and dispose of them properly. Observe the local regulations for the respective country. Ensure that no fluids (not even very small quantities) can drain into the soil, sewers, or bodies of water.



1.5.10 Implementation of safety inspections and maintenance

Disconnect the battery from the engine before performing service work. Affix a sign to the control panel - both the main and the corresponding slave panel - with the instruction "DO NOT START UP - MAINTENANCE IN PROGRESS" to prevent unintentional start-up.



To prevent sparking due to accidental short-circuiting, always remove the earthing cable (-) first and reconnect it last. Do not start work until the generator and all fluids and exhaust system parts have cooled down.

Use only suitable tooling and appliances and familiarise yourself with their functions to prevent secondary damage and/or injury.



Always keep a fire extinguisher and a first aid box handy while performing maintenance work.

1.6 Warning and instruction signs

Keep warning and instruction signs clean and legible.

Clean the signs with water and soap and dry them with a soft cloth.

Immediately replace damaged or missing warning and instruction signs. This also applies to the installation of spare parts.

1.6.1 Special instructions and hazards of generators

The electrical installations may only be carried out by trained and qualified personnel!



The generator must not be operated with the cover removed.

If the generator is being installed without a sound insulation capsule, it must be ensured that all rotating parts (belt-pulley, belts etc.) are covered and protected so that there is no danger to life and body!



If a sound insulation covering will be produced at the place of installation, then easily visible signs must show that the generator must only be switched on while the capsule is closed.



All servicing, maintenance, or repair work may only be carried out when the motor is not running.

Electrical voltages above 60 volts are always dangerous to life. The rules of the respective regional authority must be adhered to during installation. For safety reasons, only an electrician may carry out the installation of the electrical connections of the generator.

1.6.1.1 Protective conductor and potential equalisation:

Electric voltage above 60 V may be life-threatening. For this reason systems are grounded with a protective conductor. In connection with a RCD the current supply will be disconnected in case of a failure.

Appropriate safety precautions like the RCD and corresponding fuses have to be provided by the customer to guarantee a safe operation of the generator.

1.6.1.2 Protective conductor for Panda AC generators:

The generator is „earthed“ as a standard (centre and ground are interconnected in the generator terminal box by a shunt). This is a basic first-level safety measure, which offers protection as long as no other measures are installed. Above all, it is designed for delivery and a possible test run.



This „neutralisation“ (Protective Earthing Neutral - PEN) is only effective if all parts of the electrical system are jointly „earthed“ to a common potential. The shunt can be removed if this is necessary for technical reasons and another protective system has been set up instead.

While the generator is being operated, the full voltage is applied to the AC control box, as well. Therefore, it is essential to ensure that the control box is closed and secured against touch while the generator is running.



The battery must always be disconnected if work on the generator or electrical system is to be carried out, so that the generator cannot be started up unintentionally.

1.6.1.3 Switch off all loads while working on the generator

All loads must be disconnected prior to working on the generator to avoid damage to the devices. In addition, the semiconductor relays in the AC control box must be disconnected in order to avoid the booster capacitors being activated during set-up. The negative terminal of the battery must be disconnected.

Capacitors are required to run the generator. These have two varying functions:

- A) The working capacitors
- B) The booster capacitors

Both groups are located in a separate AC control box.

Capacitors store electrical energy. High voltages may remain across the capacitor contacts even after they have been disconnected from the mains. As a safety precaution, do not touch the contacts. If the capacitors must be replaced or inspected, the contacts shall be short-circuited by connecting an electrical conductor to discharge potentially remaining potential differences.

If the generator is switched off normally, the working capacitors are automatically discharged via the winding of the generator. The booster capacitors are discharged by means of internal discharge resistors.

For safety reasons, all capacitors must be discharged through short-circuiting before work is carried out on the AC control box.

1.6.1.4 Potential equalisation for Panda AGT DC generators

For further information specific to your generator, see the chapter installation.

1.6.1.5 Safety instructions concerning cables

Cable types

It is recommended to use cables that are in compliance with the standard UL 1426 (BC-5W2) with type 3 (ABYC section E-11).

Cable cross-section







The cable shall be selected taking into account the amperage, cable type, and conductor length (from the positive power source connection to the electrical device and back to the negative power source connection).

Cable installation

It is recommended to install a self-draining cable conduit classified as V-2 or higher in compliance with UL 94 in the area of the cable guide inside the capsule. It must be ensured that the cable guide is not routed along hot surfaces such as the exhaust manifold or the engine oil drain screw but instead is installed free from any influence due to friction and crushing.

1.6.2 General safety instructions for handling batteries

These instructions shall apply in addition to the instructions of the battery manufacturer:



- While you are working on the batteries, a second person should be within earshot to help you if necessary. 
- Keep water and soap ready in case battery acid is burning your skin.
- Wear eye protection and protective clothing. Do not touch your eyes while handling batteries.
- If you have acid splashes on the skin or clothing, wash them out with lots of water and soap.
- If acid sprays into your eyes, immediately flush them with clean water until no more burning is felt. Immediately seek medical assistance. 
- Do not smoke near the batteries. Avoid naked fire. The area around batteries is a potentially explosive atmosphere.
- Ensure that no tools are dropped on the battery terminals; cover them as necessary.
- Do not wear jewellery or watches on your arms during installation that might short-circuit the battery. Otherwise, there is a risk of skin burns. 
- Protect all battery contacts against accidental contact.
- For battery banks: Use only deep cycle batteries. Starter batteries are not suitable. Lead-acid gel batteries are recommended. They are maintenance-free, cycle stable, and do not release gases. 
- Never charge a frozen battery.
- Avoid battery short-circuits.
- Ensure proper ventilation of the battery to vent gases that may be released.
- Battery connection terminals must be checked for proper seating before operation. 
- Battery connection cables shall be installed with utmost care and shall be checked for excessive heating under load. Check the battery near vibrating components regularly for chafing and insulation defects. 

ATTENTION! For battery charger generators (Fischer Panda AGT-DC)!

Prior to installation, verify that the voltage of the battery bank complies with the output voltage of the generator. 

2. In case of Emergency First Aid / Im Notfall - Erste Hilfe

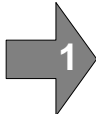
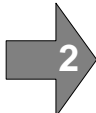
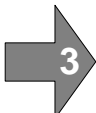

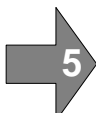



	<p>First Aid in case of accidents by electrical shocks</p> <p>5 Safety steps to follow if someone is the victim of electrical shock</p>	
	Do not touch the injured person while the generator is running.	
	Switch off the generator immediately.	
	If you cannot switch off the generator, pull, push, or lift the person to safety using a wooden pole, rope or some nonconducting material.	
	Call an emergency doctor as soon as possible.	
	Immediately start necessary first aid procedures.	

2.7 WHEN AN ADULT STOPS BREATHING

DO NOT attempt to perform the rescue breathing techniques provided on this page, unless certified. Performance of these techniques by uncertified personnel could result in further injury or death to the victim.

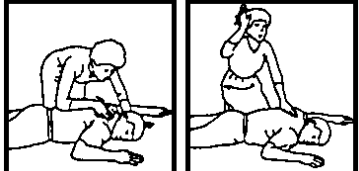
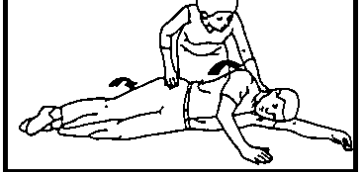
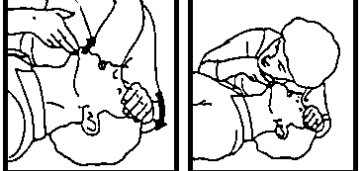
Warning:



<p>1 Does the Person Respond? Tap or gently shake victim. Shout, "Are you OK?"</p>		<p>2 Shout, "Help!" Call people who can phone for help.</p>
<p>3 Roll Person onto Back. Roll victim towards you by pulling slowly.</p>		
<p>4 Open Airway. Tilt head back, and lift chin. Shout, "Are you OK?"</p>		<p>5 Check for Breathing. Look, listen, and feel for breathing for 3 to 5 seconds.</p>
<p>6 Give 2 Full Breaths. Keep head tilted back. Pinch nose shut. Seal your lips tight around victim's mouth. Give 2 full breaths for 1 to 1½ seconds each.</p>		
<p>7 Check for Pulse at side of Neck. Feel for pulse for 5 to 10 seconds.</p>		<p>8 Phone EMS for Help. Send someone to call an ambulance.</p>
<p>9 Begin Rescue Breathing. Keep head tilted back. Lift chin. Pinch nose shut. Give 1 full breath every 5 seconds. Look, listen, and feel for breathing between breaths.</p>		<p>10 Recheck Pulse Every Minute. Keep head tilted back. Feel for pulse for 5 to 10 seconds. If victim has pulse, not breathing, continue rescue breathing. If no pulse, begin CPR.</p>

3. Basics

3.1 Intended use of the machine

The Fischer Panda generator is made to produce electrical energy out of diesel fuel.

The diesel fuel is converted to mechanical energy by the diesel engine. This mechanical energy drives the generator. In the genset, the mechanical energy is converted to electrical energy. This process is controlled by (sometimes external) components, the remote control panel and the VCS (voltage control system).

Sufficient amount of fuel and combustion air is necessary for this process. Arising exhaust and heat must be conducted according to the specification.

If the electrical power is fed to a local net, the regulations and installation instructions of the system operator and the regional authorities with reference to the power network/shipboard power supply system must be respected. Safety applications and safety devices (including lightening conductor, personal protection switch, ect.) have to be installed.

Misapplication of the product can damage and destroy the product and the electrical net inclusive all load which is attached to the net, and contain hazards like short circuit, ect. It is not allowed to modify the product in any case. Never open the sound cover during operation! The safety and hazard notes of the manual must be respected!

3.2 Purpose of the manual and description of the definitions of the trained persons/operators/users

This manual contains the working instructions and operating guidelines for the owner and user of Fischer Panda generators.

The manual is the base and the guideline for the correct installation and maintenance of Fischer Panda generators. It does not substitute the technical evaluation and should be used as an example guide only. The installation must be undertaken and proved by a suitable qualified/trained person and should be in accordance with the law as required by the country and special situation. All work has to be undertaken according to the state of the technology.

3.2.1 Trained persons

Qualified persons for the mechanical components are motor mechanics or persons with similar qualification and training.

Trained persons for the electrical components are electricians or persons with similar qualification and training.

After the installation the trained person has to instruct the operator/owner about the operation and maintenance of the generator. This must include the hazards of the generator use.

3.2.2 Operator/Owner

The operator is responsible for the operation of the generator.

After the installation, the operator/owner must be instructed concerning the operation and maintenance of the generator. This has to include the hazards during operation of the generator, different operating conditions, and instructions for the maintenance.

The operator/owner must read and follow the manual and must respect the hazard notes and safety instructions.

3.2.3 User

Users are persons, established by the operator/owner, to operate the generator.

The operator/owner has to ensure that the user has read and understood the manual and that all hazard notes and safety instructions are respected. The user must be instructed by the operator/owner regarding his activity at the generator, especially concerning the maintenance.

3.3 Components of the i-system

1. Panda i-generator

Permanent magnet generator

Fig. 3.3-1: Panda i generator



2. Panel Panda iControl with electronic board at the generator

Fig. 3.3-2: iControl panel



3. Panda PMGi inverter AC/AC

Fig. 3.3-3: PMGi inverter



4. Fischer Panda manual

The Fischer Panda manual contains the following components:

- Transparent sheet with general information, guarantee conditions, installation inspection, and service list.
- Generator manual
- Spare parts catalogue „Installation & Service Guide“
- Engine manual from the engine manufacturer
- Wiring diagram of the generator

Fig. 3.3-4: Manual



Optional components

Optional components could be for example:

- fuel pump
- installation kits

3.4 Panda transport box

3.4.1 Bolted Fischer Panda transport box

1. Remove the bolts for cover / sidewalls
2. Remove the cover
3. Remove the loose accessories
4. Remove the bolts for sidewalls / floor pallet
5. Remove the sidewalls
6. Open the generator attachment

3.4.2 Fischer Panda transport box with metal tab closure

1. Bend up the metal tab closures on the transport box lid
2. Remove the cover
3. Remove the loose
4. Bend open the metal tab closures at the bottom of the transport box
5. Remove the sidewalls
6. Open the generator attachment

3.5 Opening the MPL sound insulation capsule

To open the sound insulation capsule, the closures must be rotated roughly 180° counter-clockwise. Use a flat head screwdriver. Pull the sidewalls out by gripping into the slots.



Closure locked

Fig. 3.5-1: Sound insulation capsule, side part



Fig. 3.5-2: Closure locked



Closure open

Fig. 3.5-3: Closure open



3.5.1 Opening the GFK sound insulation capsule

GFK sound insulation capsule with lash closures

Fig. 3.5-1: Lash closures



To open the lash closures pull the handle in arrow direction and lift the lash of the closure pin. After lifting off the lashes, the sound isolation cover upper part can be removed.

Fig. 3.5-2: Lash closures

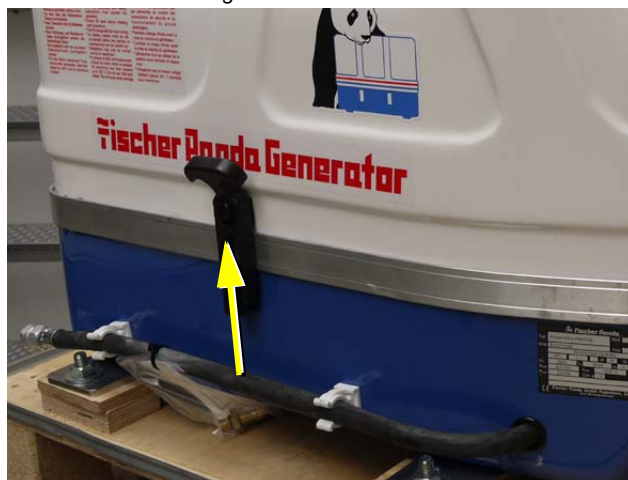

3.6 Transport and loading/unloading

3.6.1 Transporting the generator

- The generator must always be upright for transport.
- For transport, the Fischer Panda transport box shall be used for the generator. The generator shall be securely attached to the bottom of the box.
- For loading/unloading, an adequate industrial truck shall be used.
- Depending on the transport distance (e.g. air cargo), the generator fluids (coolant, engine oil, fuel) may have to be drained. The corresponding instructions and warnings must be fitted to the transport packaging.

3.6.2 Loading/unloading of the generator

For loading/unloading the generator, appropriate ring eye bolts shall be installed in the holes in the support rails. The load bearing capacity of each ring eye bolt must at least equal the generator weight.

An adequate lifting yoke shall be used for transport/loading.

Fig. 3.6.2-1: Lifting yoke (example)



3.7 Special service instructions and measures for extended machine downtimes and decommissioning

The decommissioning and storage must be undertaken and **Note:** proved regarding the operation and storage situation.

Fischer Panda takes no responsibility for damages through wrong decommissioning and storage.

Downtimes are categorised in the following groups:

- Short downtime (1 to 3 months)
- Medium term downtime / hibernation (3 to 6 months)
- Extended downtime / decommissioning (more than 6 months)



3.7.1 Instructions for the starter battery for extended downtimes

Starter batteries

Self-discharge of batteries is a physical and chemical process and cannot be avoided even if the battery is disconnected

- For extended downtimes, the battery shall be disconnected from the genset.
- Charge battery regularly. Observe instructions of the battery manufacturer.

Depending on the battery type, check the acid level before charging and refill each cell up to the marking using distilled water as necessary.

Modern starter batteries are typically maintenance-free.

Deep discharge will damage the battery and can render it unusable.

Keep battery clean and dry. Clean battery poles (+ and -) and terminals regularly and coat with acid-free and acid-resistant grease. During assembly, ensure good contact of the terminal connections.

General limits for lead-acid batteries:

2.1 V / cell corresponds with full battery (charged).

1.95 V / cell corresponds with empty battery - recharge.

For a 12 V battery, the following applies:

- 11.7 V lower open-circuit voltage (battery empty), recharge battery.
- 12.6 V upper open-circuit voltage (full battery) - trickle charge full battery at 13.2 V.

For a 24 V battery, the following applies:

- 23.4 V lower open-circuit voltage (battery empty), recharge battery.
- 25.2 V upper open-circuit voltage (full battery) - trickle charge full battery at 26.4 V.

These values are based on a battery temperature of 20-25°C. Observe the instructions from the battery manufacturer.

Fischer Panda recommends:

- Install battery circuit breaker and switch to OFF on the machine. (Cutting the battery circuit.)
- Secure the battery plus terminal close to the battery.
- Regularly check contacts for corrosion.

Note: Information starter battery



Note: Starter battery recommendation



3.7.2 Measures for short downtimes

Short downtime (1 to 3 months)

- Measure battery charge status based on open-circuit voltage.
- During downtimes >7 days, disconnect battery (e.g. battery main switch to position 0).
- Check the battery within 2 months and allow the engine to warm up for min. 10 min.
- Fill fuel tank to 100% (level to full).

3.7.3 Measures for medium term downtimes / hibernation

Medium term downtimes (3 to 6 months)

3.7.3.1 Courses for preservation:

- Check battery charge status and recharge regularly, roughly every 2 months, as necessary. Observe instructions of the battery manufacturer.
- Check cooling water anti-freeze level and refill as necessary.

The anti-freeze agent must not be older than 2 years. The anti-freeze content shall be between 40 % and 60 % to ensure corrosion protection of the cooling water circuit. Top off coolant if necessary.

If the cooling water is drained, e.g. after engine surface protection is applied, no water may remain inside the engine during the downtime. The control unit must be marked accordingly with a note specifying "NO COOLING WATER".

- Drain engine oil as specified. Refill engine with preservative oil to the max. level on the oil dipstick.
- Drain diesel from tank and refill with a protective mixture (90 % diesel and 10 % preservative oil) (level to full).

Crank engine without start.

- Dismount V-belt as specified, wrap and store in a dry location. Protect against UV radiation.

Cover alternator apertures.

Attention!

Cleaning fluids and preservatives must not enter the alternator. Risk of destroying the alternator.



- Clean engine as per manufacturer's instructions.
- Spray engine parts and V-belt disks with preservative.
- Clean air filter housing and spray with preservative (metal housing only).
- Close off intake and exhaust apertures (e.g. with tape or end caps).

Before recommissioning, remove preservatives and protective measures.

Attention!



3.7.3.2 Measures for removing surface protection after medium term downtimes (3 to 6 months).

- Check battery charge status and recharge if necessary. Observe instructions of the battery manufacturer.
- Check cooling water anti-freeze level and cooling water level and refill as necessary.
- Drain engine oil. Replace oil filter and engine oil as per the specification.
- Remove preservatives from the engine with petroleum spirit.
- Degrease V-belt disks and mount V-belt according to instructions. Check V-belt tension!
- If applicable, open turbocharger oil pressure line and fill clean engine oil into channel.
- Hold engine stop lever in zero delivery position and crank engine manually several times.
- Clean air filter housing with petroleum spirit, check air filter and replace if necessary.
- Remove covers from exhaust aperture and intake apertures.
- Connect battery. Close battery main switch.
- Hold stop lever on generator motor in neutral position and crank starter for approx. 10 seconds. Then, pause for 10 seconds. Repeat this procedure 2 times.
- Perform visual check of the generator similar to initial commissioning and start up generator.

3.7.4 Measures for extended downtimes / decommissioning

Downtimes (more than 6 months)

3.7.4.1 Courses for preservation:

- Check battery charge status and recharge regularly, roughly every 3 months, as necessary. Observe instructions of the battery manufacturer.
- Check cooling water anti-freeze level and refill as necessary.

The anti-freeze agent must not be older than 2 years. The anti-freeze content shall be between 40 % and 60 % to ensure corrosion protection of the cooling water circuit. Top off coolant if necessary.

If the cooling water is drained, e.g. after engine surface protection is applied, no water may remain inside the engine during the downtime. The control unit must be marked accordingly with a note specifying "NO COOLING WATER".

- Drain engine oil as specified. Refill engine with preservative oil to the max. level on the oil dipstick.
- Drain diesel from tank and refill with a protective mixture (90 % diesel and 10 % preservative oil) (level to full).

Crank engine without start.

- Dismount V-belt as specified, wrap and store in a dry location. Protect against UV radiation.
- Disconnect battery. Coat terminals with acid-free grease.

Cover alternator apertures.

Attention!



Cleaning fluids and preservatives must not enter the alternator. Risk of destroying the alternator.

- Clean engine as per manufacturer's instructions.
- Spray engine parts and V-belt disks with preservative.
- Clean air filter housing and spray with preservative (metal housing only).
- Spray preservative on intake and exhaust side of exhaust turbocharger (where applicable) and reconnect the lines.
- Remove valve cover and spray inside of valve cover, valve stems, springs, rocker, etc. with preservative oil.
- Remove injection nozzle and coat cylinder surface with preservative oil. Hold stop lever in zero delivery position and crank engine manually several times. Refit injection nozzles with new seals (at an operation hour of min. 100 hours after the last change). Observe torque values.
- Spray radiator cover and tank cover or radiator cover on expansion tank lightly with preservative oil and refit.
- Close off intake and exhaust apertures (e.g. with tape or end caps).

For storage for more than 12 months, the preservation measures shall be checked annually and supplemented as necessary.

Note:



Before recommissioning, remove preservatives and protective measures.

Attention!



3.7.4.2 Measures for removing surface protection after extended downtimes / recommissioning (over 6 months):

- Check battery charge status and recharge if necessary. Observe instructions of the battery manufacturer.

- Check cooling water anti-freeze level and cooling water level and refill as necessary.
- Drain engine oil. Replace oil filter and oil as per the specification.
- Remove preservatives from the engine with petroleum spirit.
- Degrease V-belt disks and mount V-belt according to instructions. Check V-belt tension!
- If applicable, open turbocharger oil pressure line and fill clean engine oil into channel.
- Hold engine stop lever in zero delivery position and crank engine manually several times.
- Clean air filter housing with petroleum spirit, check air filter and replace if necessary.
- Remove covers from exhaust aperture and intake apertures.
- Connect battery. Close battery main switch.
- Hold stop lever on generator motor in neutral position and crank starter for approx. 10 seconds. Then, pause for 10 seconds. Repeat this procedure 2 times.
- Perform visual check of the generator similar to initial commissioning and start up generator.

Fischer Panda recommends:

After extended downtimes, a full 150 h inspection as per the inspection list should be performed.

Note:

4. Panda 15000i PMS generator

4.1 Type plate at the generator

Fig. 4.1-1: Panda 15000i PMS generator

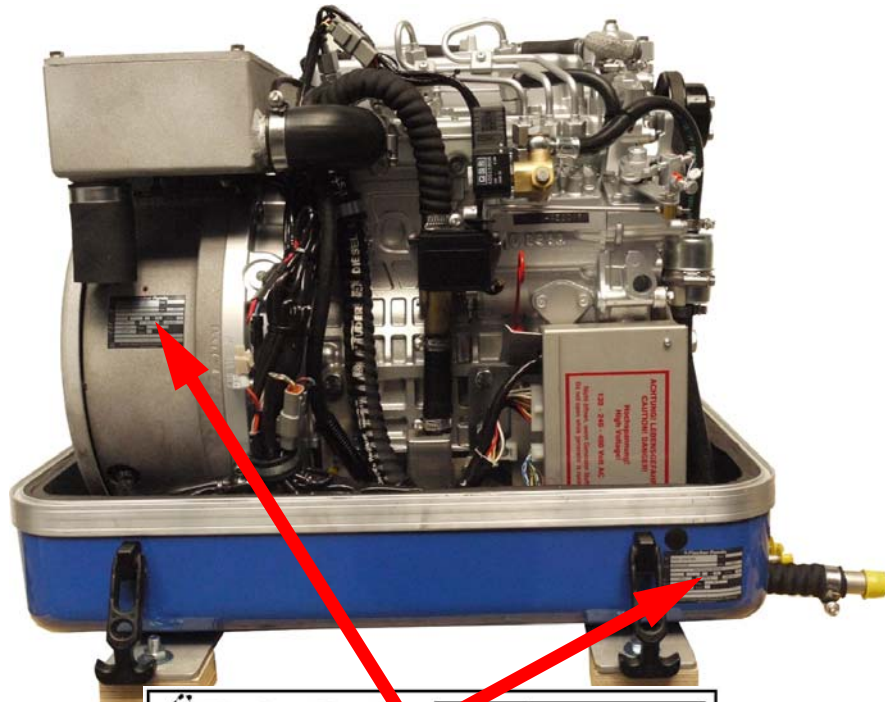



		S/No	
Typ		Year	
Mod.		Weight	
Art. No		T _{amb max}	
		P _n	
U _n		S _n	
f _n		Cos φ	
I _n		P _{con}	
Fischer Panda GmbH Otto-Hahn-Str. 40 33104 Paderborn Germany		www.fischerpanda.de	
			

Fig. 4.1-2: Type plate

		S/No		Serial number
Type description	Typ	Year		Year of manufacture
Model	Mod.	Weight		Weight
Articel number	Art. No	T _{amb max}		Ambient temperature
Interlinking		P _n		Nominal real power
Nominal voltage	U _n	S _n		Nominal apparent power
Nominal frequency	f _n	Cos φ		Nominal power factor
Nominal current	I _n	P _{con}		Electrical continuous power
Fischer Panda GmbH Otto-Hahn-Str. 40 33104 Paderborn Germany		www.fischerpanda.de		
				

4.2 Description of the generator

4.2.1 Right side view

Fig. 4.2.1-1: Right side view

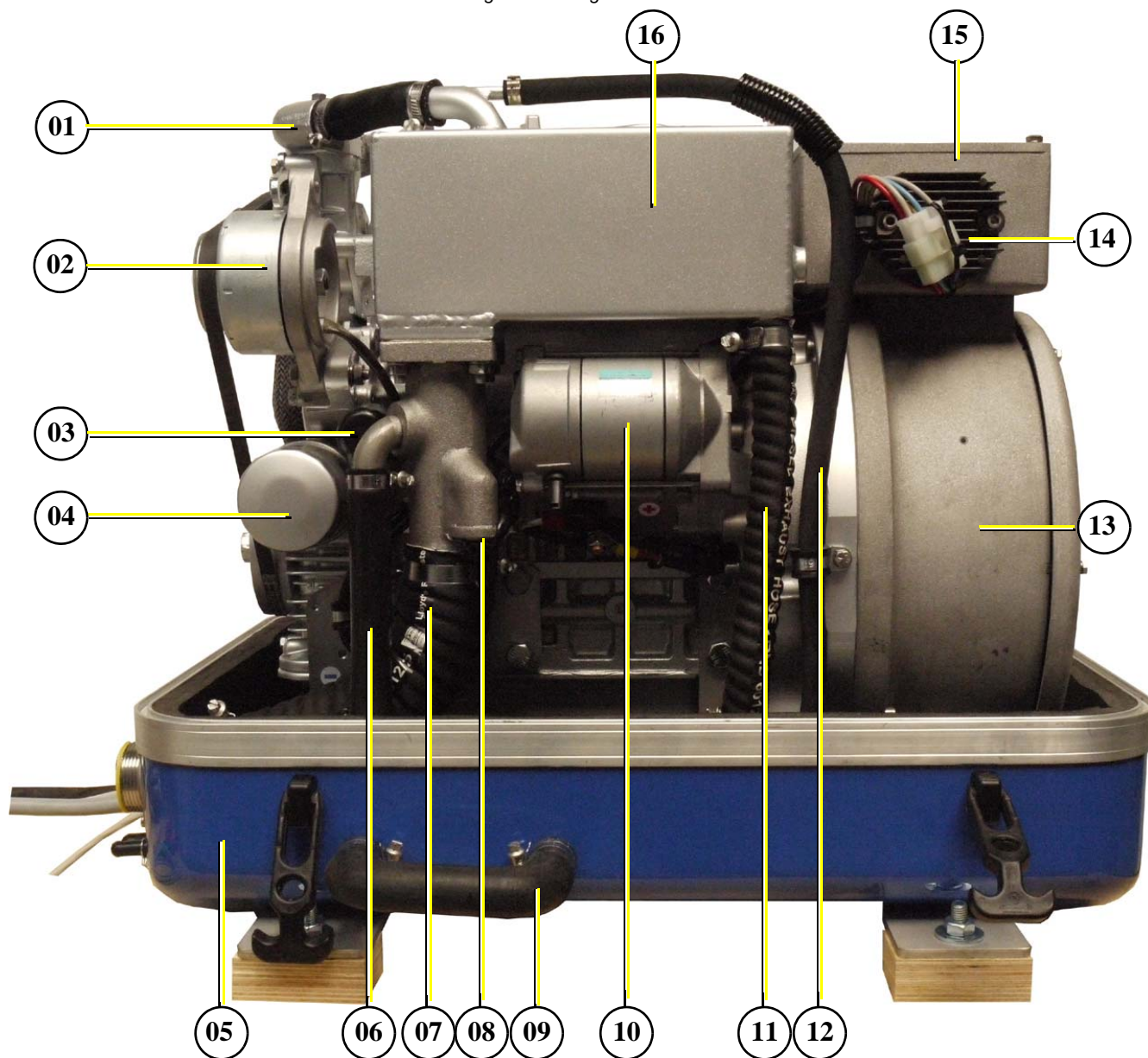

- 01) Thermostat housing
- 02) DC-alternator 12V
- 03) Oil pressure switch
- 04) Oil filter
- 05) Sound cover base part
- 06) Raw water injection pipe
- 07) Exhaust hose
- 08) Thermosensor

- 09) Connection for external ventilation valve
- 10) Starter motor
- 11) Freshwater return hose
- 12) Ventilation pipe to external expansion tank
- 13) Generator housing with coil
- 14) Charge controller for DC-alternator
- 15) Air suction housing
- 16) Watercooled exhaust elbow

4.2.2 Left side view

Fig. 4.2.2-1: Left side view

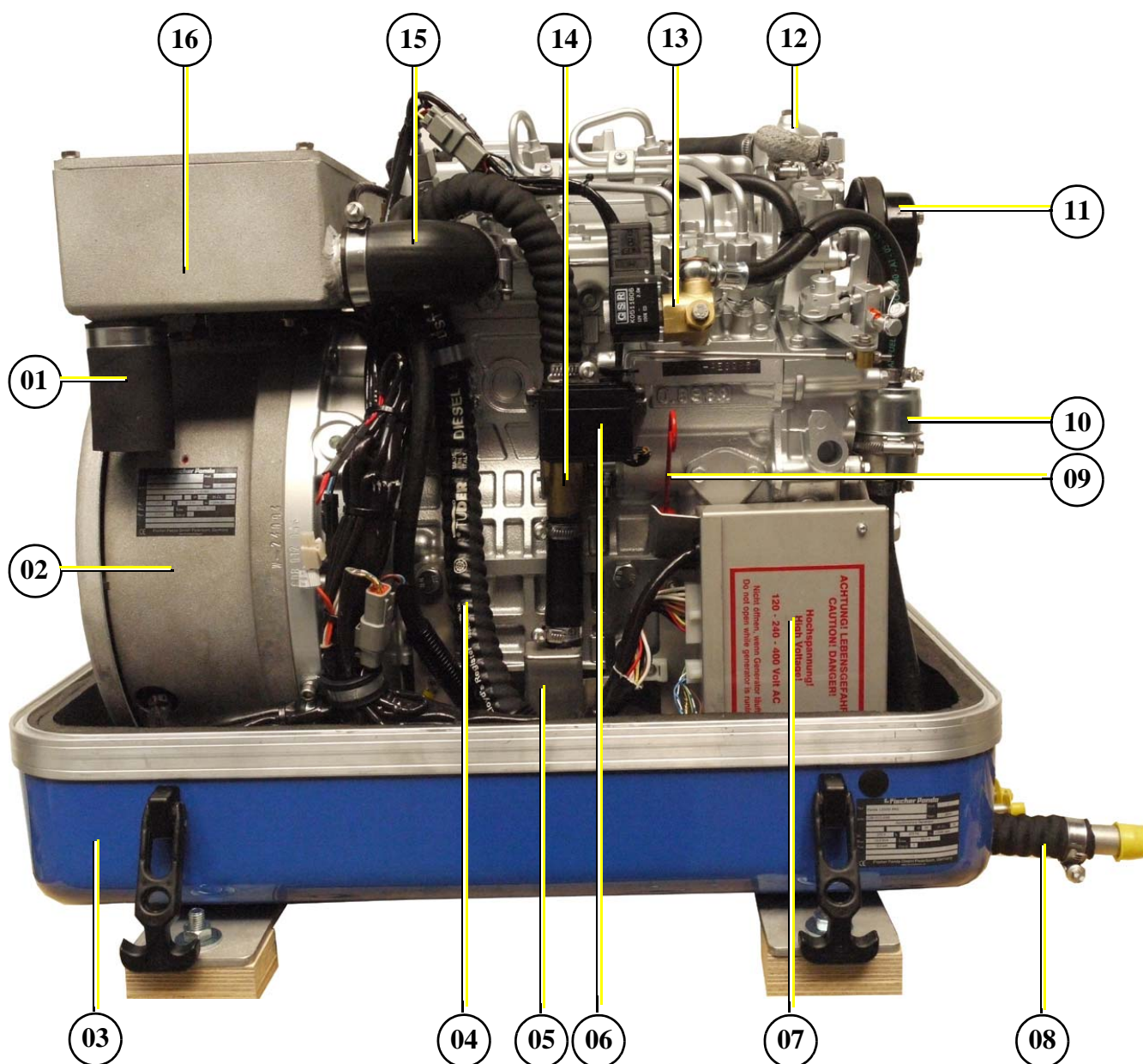

- | | |
|--|---|
| 01) Suction air intake | 09) Oil dipstick |
| 02) Generator housing with coil | 10) Fuel filter |
| 03) Sound cover base part | 11) Pulley for internal cooling water pump |
| 04) Raw water intake hose | 12) Thermostat housing |
| 05) Impeller filter | 13) Fuel solenoid switch |
| 06) Actuator | 14) Raw water pump |
| 07) Housing with iControl electronic board (DO NOT OPEN) | 15) Suction hose, air suction housing - induction elbow |
| 08) Raw water intake | 16) Air suction housing |

4.2.3 Front view

Fig. 4.2.3-1: Front view

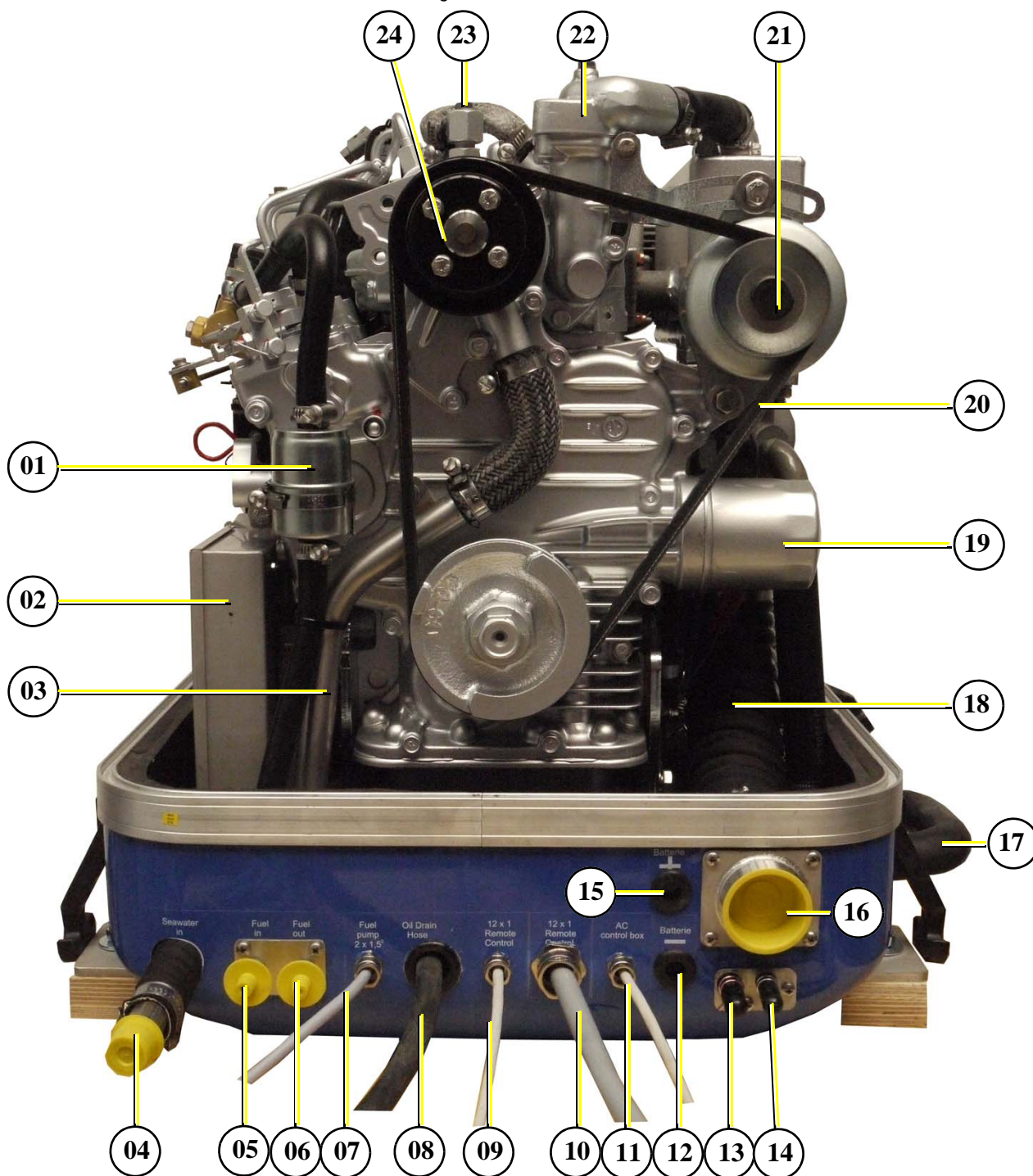

- | | |
|--|---|
| <ul style="list-style-type: none"> 01) Fuel filter 02) Housing with iControl electronic board (DO NOT OPEN) 03) Cooling water pipe, heat exchanger - water pump 04) Raw water intake 05) Fuel IN 06) Fuel OUT 07) Cable for fuel pump 08) Oil drain hose 09) Cable for iControl panel 10) Cable for generator output AC out (to inverter) 11) Cable for inverter control 12) Passage for starter battery cable (-) | <ul style="list-style-type: none"> 13) Connection from external expansion tank 14) Connection to external expansion tank 15) Passage for starter battery cable (+) 16) Exhaust outlet 17) Connection for external ventilation valve 18) Exhaust hose 19) Oil filter 20) V-belt 21) DC-alternator 12V 22) Thermostat housing with ventilation screw 23) Ventilation screw internal cooling water pump 24) Pulley for internal cooling water pump |
|--|---|

4.2.4 Back view

Fig. 4.2.4-1: Back view

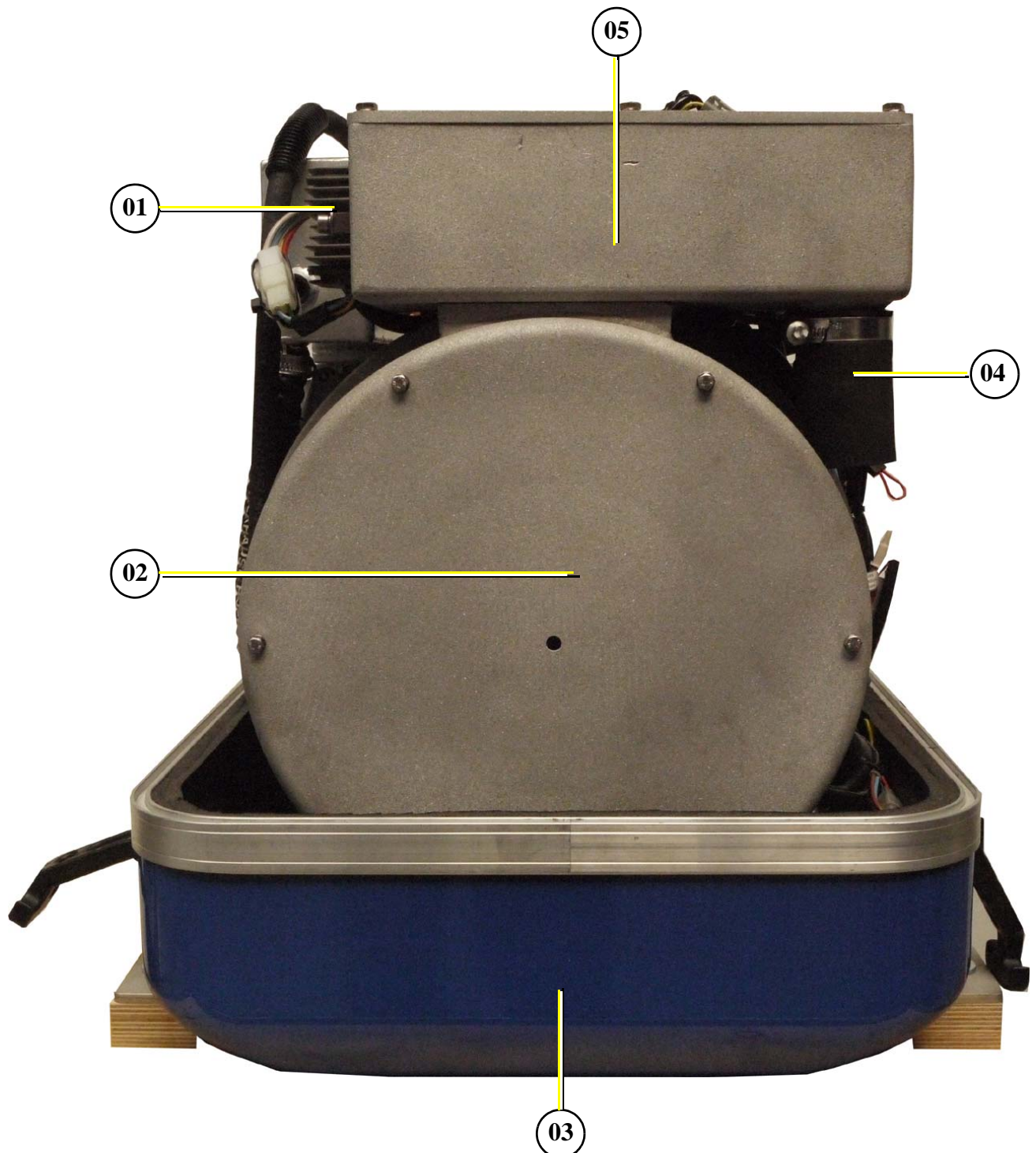

- 01) Charge controller for DC-alternator
- 02) Generator front cover
- 03) Sound cover base part

- 04) Suction air intake
- 05) Air suction housing

4.2.5 View from above

Fig. 4.2.5-1: View from above

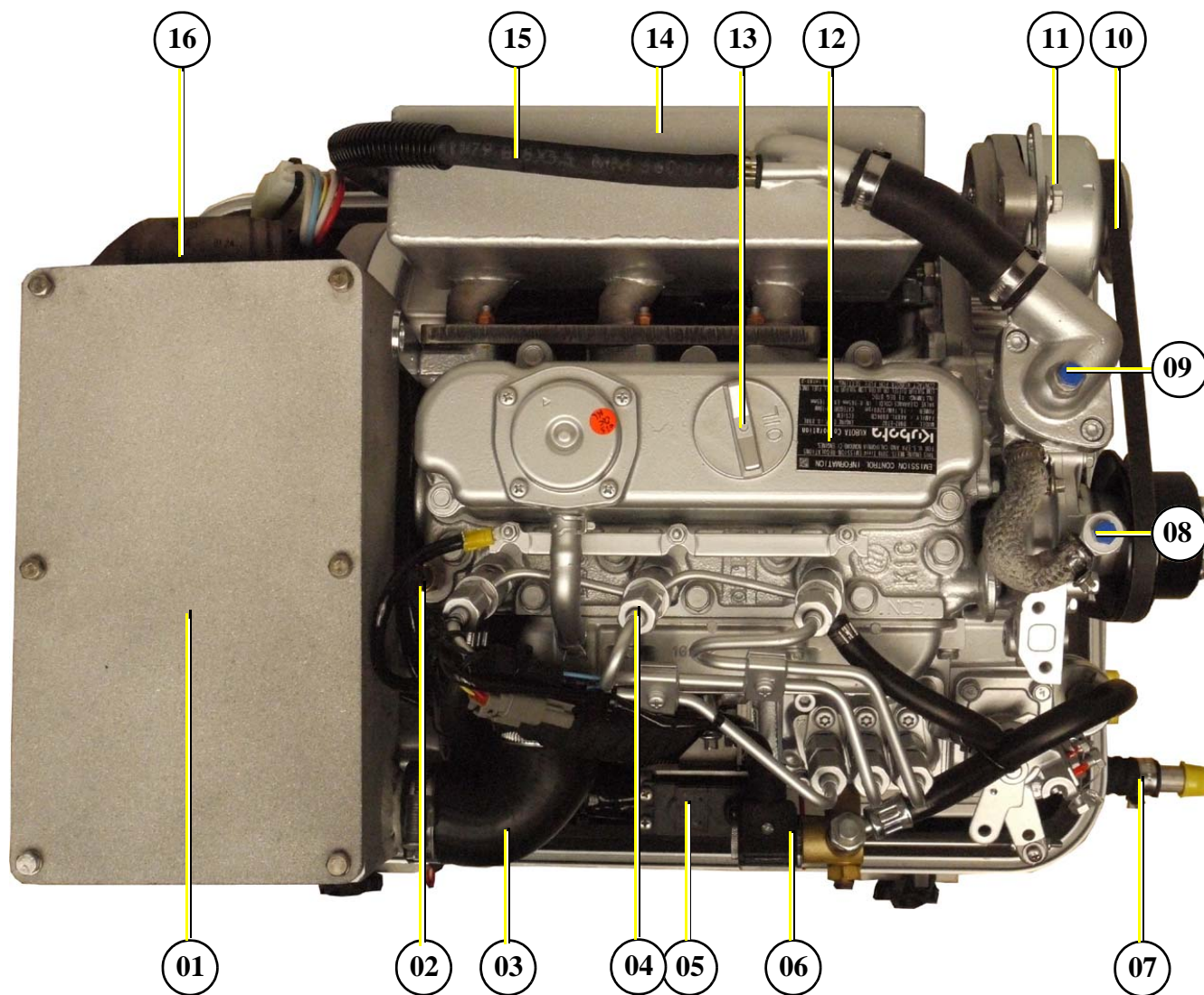

- | | |
|---|---|
| 01) Air suction housing | 09) Ventilation screw thermostat housing |
| 02) Thermoswitch cylinder head | 10) V-belt |
| 03) Suction hose, air suction housing - induction elbow | 11) DC-alternator 12V |
| 04) Injection nozzle | 12) Valve cover |
| 05) Actuator | 13) Oil filler neck with cap |
| 06) Fuel solenoid valve | 14) Watercooled exhaust elbow |
| 07) Raw water intake | 15) Ventilation pipe to external expansion tank |
| 08) Ventilation screw internal cooling water pump | 16) Charge controller for DC-alternator |

4.3 Details of function units

4.3.1 Remote control panel - See Panda iControl manual

4.3.2 Components of the cooling system (raw- and freshwater)

Fig. 4.3.2-1: Cooling system

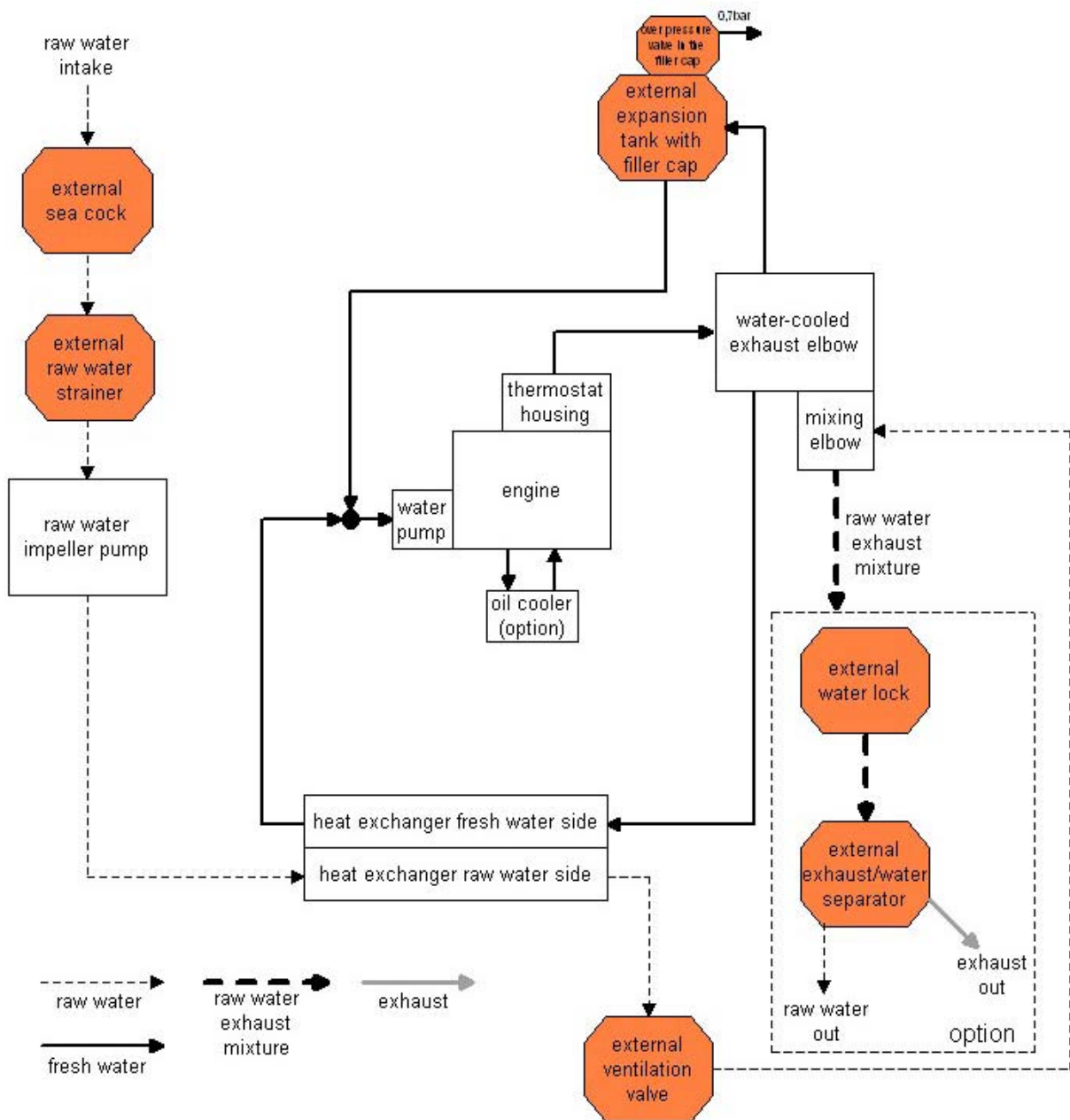

4.3.3 Components of the fuel, air intake and exhaust system

Fig. 4.3.3-1: Fuel, air intake and exhaust system

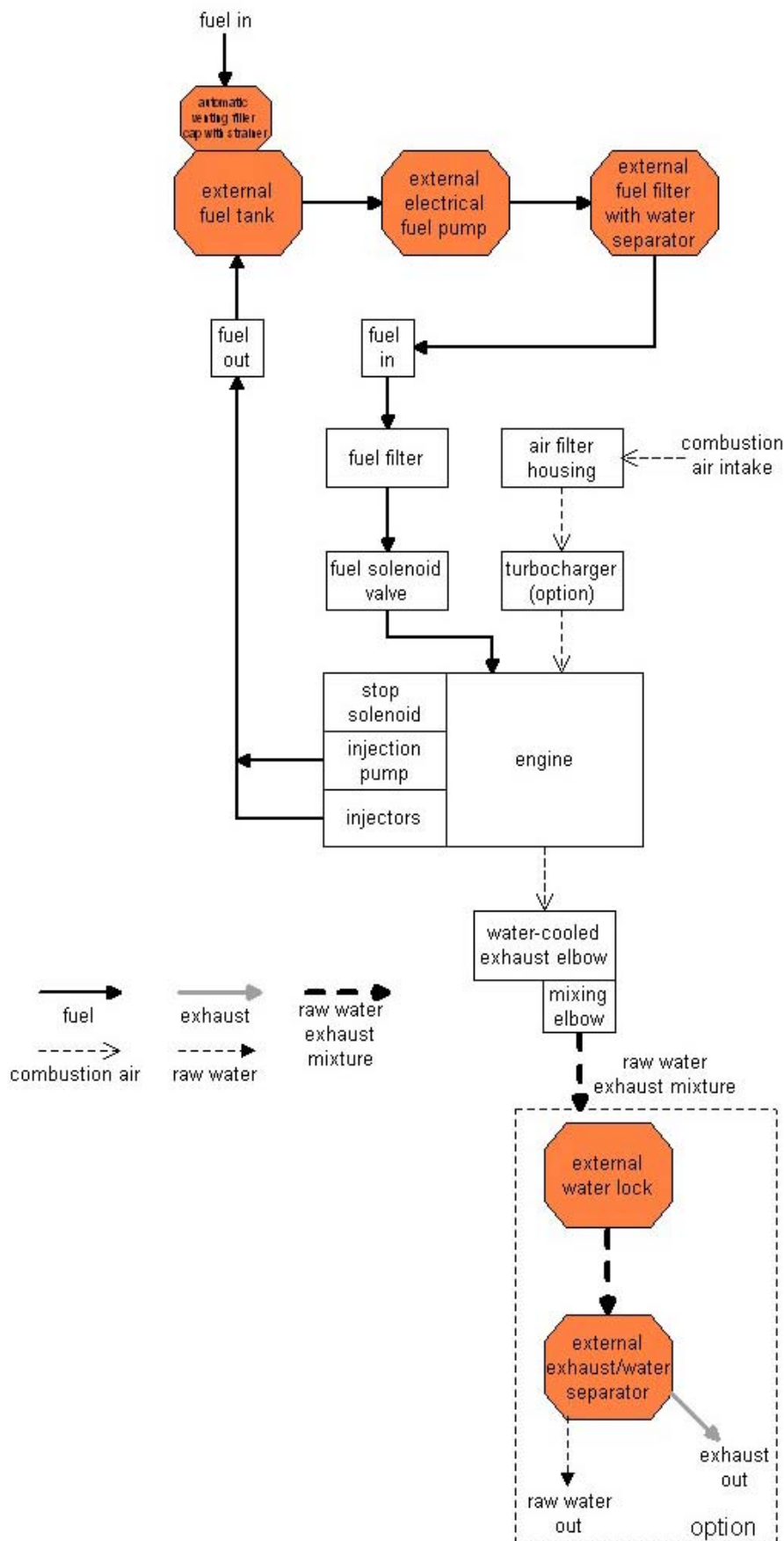

4.3.4 Components of the electrical system

Fig. 4.3.4-1: Electrical system

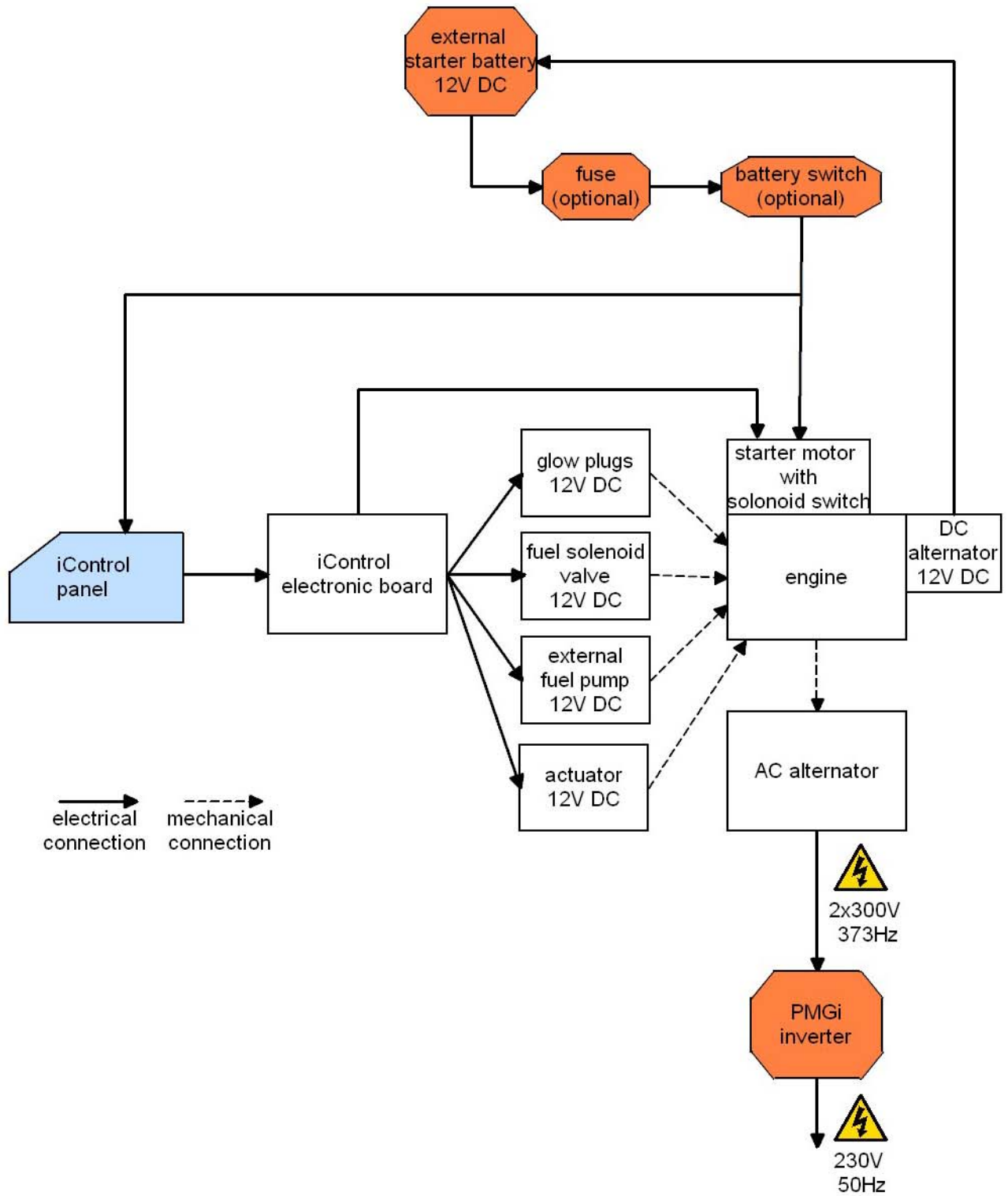

4.3.5 Components of the lubrication system

Fig. 4.3.5-1: Lubrication system

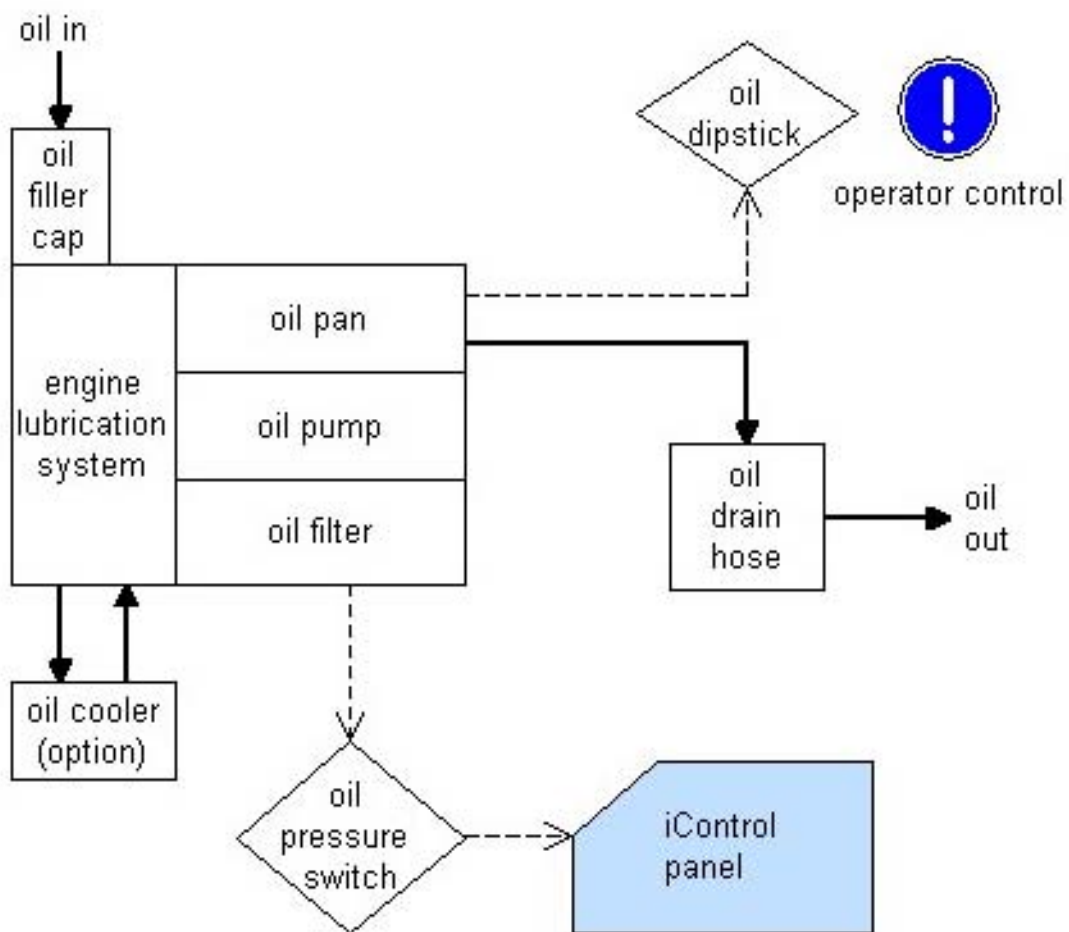

4.3.6 Sensors and switches for operating surveillance

Thermo-switch at engine

The thermo-switch at the engine is used for monitoring the engine temperature.

Fig. 4.3.6-1: Thermo.switch at engine



Thermo-sensor at exhaust connection

If the impeller pump drops out and delivers no more raw water, the exhaust connection becomes extremely hot.

Fig. 4.3.6-2: Thermo-sensor at exhaust connection



Thermo-switch coil

One thermo sensor is located in the stator winding

Fig. 4.3.6-3: Thermo-switch coil

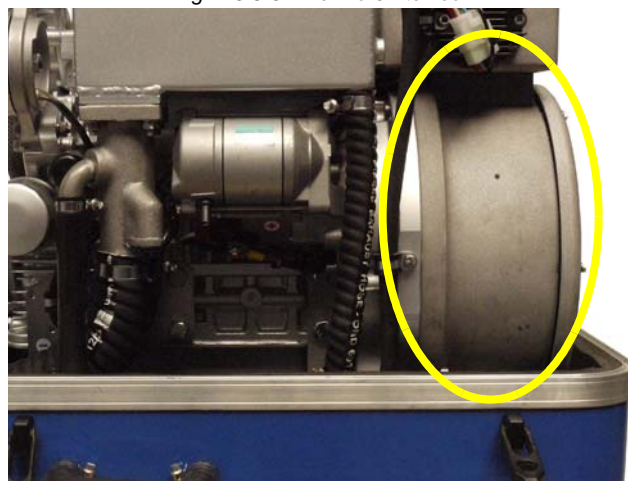

Oil pressure switch

In order to be able to monitor the lubricating oil system, an oil pressure switch is built into the system.

Fig. 4.3.6-4: Oil pressure switch

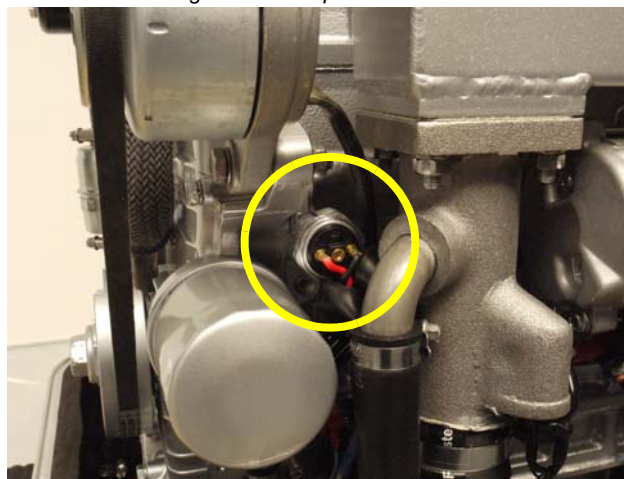

4.4 Operation instructions - See Panda iControl panel manual

4.4.1 Daily routine checks before starting - See Panda iControl manual

4.4.2 Starting generator - See Panda iControl manual

4.4.3 Stopping the generator - See Panda iControl manual

5. Installation Instructions

The PMGi cable must be secured at the generator and at the PMGi with appropriate safety devices.

ATTENTION!



All connections (hoses, wires etc.) and installation instructions are designed and suited for “standard” installation situations.

Attention!: Adapt system correctly.



In situations where Fischer Panda has no detailed information concerning certain installation requirements (such as vehicle specifications, maximum vehicle speed - and all other conditions concerning special operating situations) the installation instructions should be used as an example guide only. The installation must be undertaken and proved by a suitable qualified/trained person and should be in accordance with the law as required by the country and special situation.

Damages caused by faulty or incorrect installation are not covered by the warranty.

5.1 Personal requirements

The described installation must be done by a technical trained person or a Fischer Panda service point.

5.1.1 Hazard notes for the installation

see “Safety first!” on Page 12.

Notice:



Follow the general safety instruction at the front of this manual.

DANGER TO LIFE! - Incorrect handling may lead to health damage and to death.

.Warning!: Automatic start



Always disconnect the battery bank (first negative terminal than positive terminal) before you work at the generator or the electric system of the generator so that the generator may not be started unintentionally.

Improper installation can result in severe personal injuries or material damage. Therefore:

Warning!: Risk of injury



- Always undertake installation work when the generator is switched off.
- Ensure there is sufficient installation clearance before start working.
- Ensure tidiness and cleanliness at the workplace. Loose components and tools lying around or on top of each other are sources of accidents.
- Only perform installation work using commercially available

tools and special tools. Incorrect or damaged tools can result injuries.

Oil and fuel vapours can ignite at contact with ignition sources. Therefore:

- No open flames during work on the generator.
- Do not smoke.
- Remove oil and fuel residues from the generator and floor.

Contact with engine oil, antifreeze and fuel can result in damage to health. Therefore:

- Avoid skin contact with engine oil, fuel and antifreeze.
- Remove oil and fuel splashes and antifreeze from the skin immediately.
- Do not inhale oil and fuel vapours.

DANGER TO LIFE! - Improper handling can result in severe personal injury and death.

Electrical voltages above 60 volts (battery chargers greater than 36 volts) are always dangerous to life. The rules of the respective regional authority must be adhered to. Only an electrician may carry out installation of the electrical connections for safety reasons.

Generator, oil and antifreeze can be hot during/after operation. Risk of severe burns!

During operation an over pressure in the cooling system may be established.

Batteries contain corrosive acids and bases.

Improper handling can lead to heating of the batteries and bursts. Corrosive acids and bases may leak. Under bad conditions it may lead to an explosion.

Consider the instructions of the battery manufacturer.

During installation/maintenance personal protective equipment is required to minimize the health hazards:

- Protective clothing
- Safety boots
- Protective gloves
- Ear defender
- Safety glasses

Disconnect all load during the work at the generator to avoid damages at the load.

Warning!: Danger of fire



Danger!: Danger of poisoning



Attention!: Danger to Life - High voltage



Warning!: Hot surface/material



Warning: Danger of chemical burns



Instruction!: Personal protective equipment necessary



Attention!: Disconnect all load.



5.2 Place of installation

5.2.1 Preliminary remark

- There must be sufficient fresh air supply for the combustion air.
- It has to be ensured that the cooling air supply from underneath or sidewise is sufficient.
- During operation the sea cock has to be opened.
- The generator may only be opened by a technical trained person.
- The generator may only be operated by a trained person.

5.2.2 Preparing the base - placement

Since Panda generators have extremely compact dimensions, they can be installed in tight locations. Attempts are sometimes made to install them in almost inaccessible places. Please consider that even almost maintenance-free machinery must still remain accessible at least at the front (drive belt, water pump) and the service-side (actuator, dipstick). Please also note that in spite of the automatic oil-pressure sensor it is still essential that the oil level has to be checked regularly.

The generator should not be placed in the proximity of light walls or floors, which can have resonance vibrations because of airborne sounds. If this should be unavoidable, then it is recommended that this surface is lined with 1 mm lead foil, which will change the mass and the vibration behaviour.

You should avoid fixing the generator on a slippery surface with little mass (i.e. plywood). This acts as an amplifier of airborne sounds in the most unreasonable case. An improvement can be achieved by reinforcing these surfaces with ribs. In addition, the breakthroughs, which interrupt these surfaces, should be sawed off. The lining of the surrounding walls with a heavy layer (i.e. lead) and foam additionally improve the conditions.

As the generator sucks in its combustion air via several drill holes in the capsule base, the capsule base must be installed with sufficient space to the basement so that the air supply is guaranteed (at least 12 mm/½")

The generator sucks its air from the surrounding engine room. Therefore it must be ensured that sufficient ventilation openings are present, so that the generator cannot overheat.

The Power out of the generator based on the following data:

Ambient temperature: 20°C

Air pressure: 1000mbar (100m above normal Zero)

Raw water temperature: 20°C

Rel. air moisture: 30% reg. the ambient temperature

Fuel temperature: bis zu 20°C

Exhaust backpressure: 80mbar (at the exhaust out of the sound isolation cover)

Any different to this data, for example an ambient temperature of 40°C because of the build inside a machine room/vehicle with a bad ventilation, will cause in a lower Power out (Derating).

5.2.3 Advice for optimal sound insulation

The convenient base consists of a stable framework, on which the generator is fastened by means of shock-mounts. Since the aggregate is „free“ downwards, the combustion air can be sucked in unhindered. In addition the vibrations are void which would arise with a closed capsule base.

Fig. 5.2.3-1: Generator base

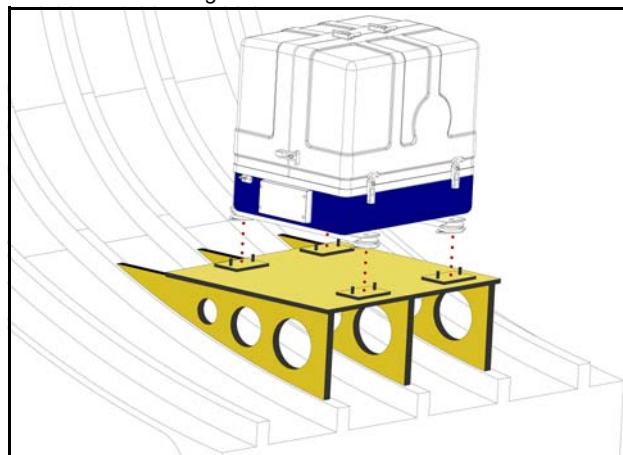

5.3 Generator Connections

Sample for the connection at the Fischer Panda generator. See the description of the generator for the original location.

All electrical wires are connected within the capsule tightly to the motor and the generator. This is also the case for fuel lines and cooling water lines.

The electrical connections **MUST** be carried out according to the respective valid regulations. This also concerns used cable materials. The cable supplied is meant for laying „protected“ (i.e. in pipe) at a temperature up to a max of. 70 °C (160 °F). The on-board circuit must also be fitted with all essential fuses.

Before working (installation) on the System read the section „Safety Instructions“ in this manual.

ATTENTION!



Fig. 5.3-1: Connection at the Generator - sample

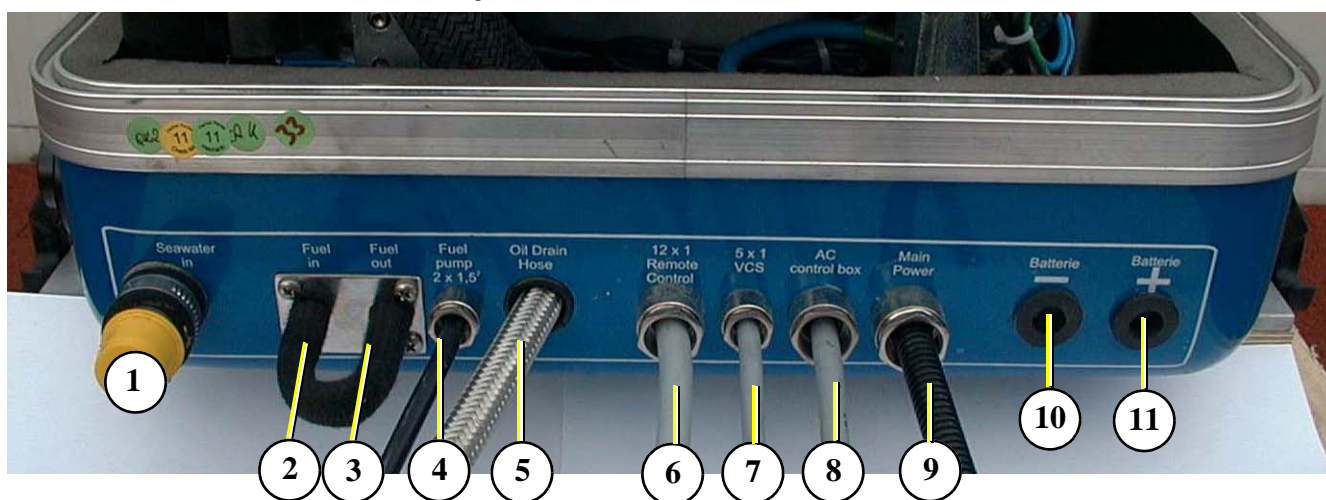

- | | |
|--|--|
| <ul style="list-style-type: none"> 1. Raw water intake 2. Fuel intake from tank to generator 3. Fuel return from generator to tank 4. Electrical line for fuel pump 5. Engine oil drain hose 6. Electrical line for remote control panel | <ul style="list-style-type: none"> 7. Electrical cable for AC control box (VCS-control) 8. Electrical cable for AC control box (230V und 400V) 9. Generator AC-output 10. Generator starter battery negative cable (-) 11. Generator starter battery positive cable (+) |
|--|--|

Example - see section 5.2 for detailed information

Fig. 5.3-2: Connection at the Generator - sample

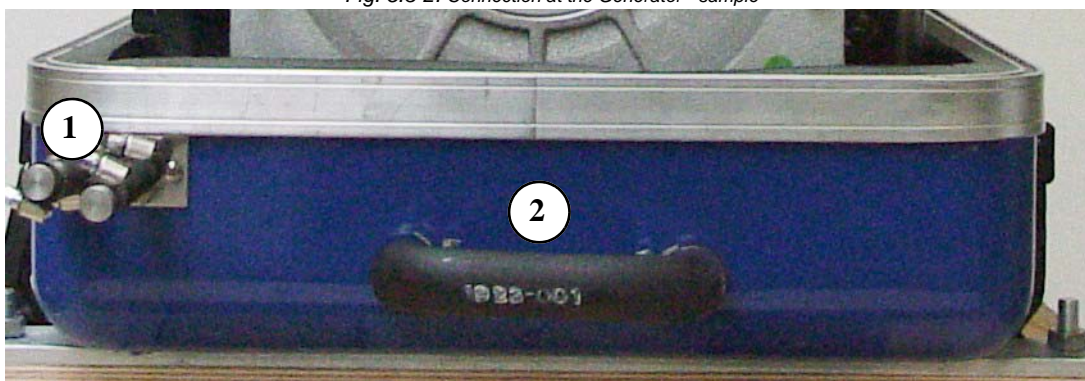

- 1) External cooling water expansion tank
- 2) External ventilation valve

Example - see section 5.2 for detailed information

5.4 Installation of the cooling system - raw water

5.4.1 General information

The genset should have its own raw water (coolant water) inlet and should not be connected to any other engine systems. Ensure that the following installation instructions are complied with:

5.4.2 Installation of the through hull fitting in Yachts - scheme

It is good practice for yachts to use a through hull fitting with an integrated strainer. The through hull fitting (raw water intake) is often mounted against the sailing direction to induce more water intake for cooling.

For Panda generators, the through hull inlet should NOT point in the sailing direction! When sailing at higher speeds more water will be forced into the inlet than the pump can handle and your generator will flood.

Fig. 5.4.2-1: Position of the through hull fitting

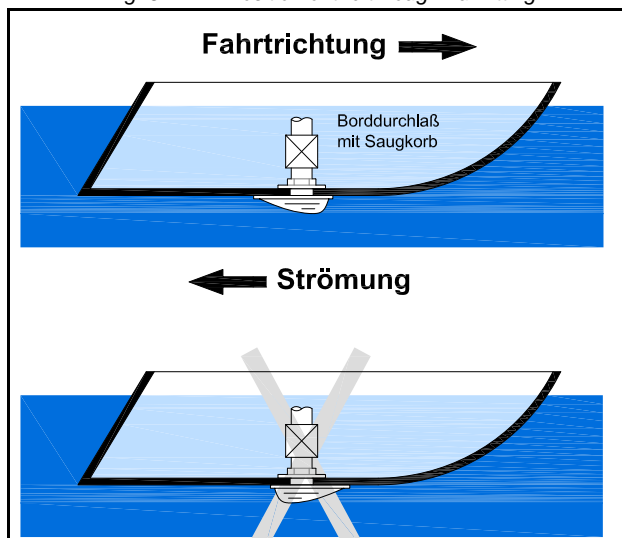

5.4.3 Quality of the raw water sucking in line

In order to keep the suction resistance in the line at a minimum, the raw water intake system must have an inner diameter of at least 1" (25 mm).

This applies also to installation components such as through-hull fitting, sea cock, raw water filter etc.

The intake suction line should be kept as short as possible. Install the raw water inlet in close proximity to the genset.

After start-up the cooling water quantity must be measured (e.g. by catching at the exhaust). The flow rate,

as well as the necessary cross section of the cooling water pipe see section 9.7, "Diameter of conduits," on page 115

5.4.4 Generator installation above waterline

The Panda is equipped with a water intake pump mounted on the motor. Since the intake pump is an impeller pump there are wearing parts which are likely to require replacement after a period of time. Ensure that the genset is installed so that the intake pump can be easily accessed. If this is not possible, an external intake pump could be installed in an easily accessible location

If the generator is installed above the waterline, it is possible that the impeller will wear out faster, because after starting, the pump runs dry for some seconds. The raw water hose should form a loop as near as possible to the raw water inlet of the generator (see picture below). This ensures the pump only sucks in air for a short time. The impeller pump will be lubricated by raw water and the impeller life span will be increased. With the installation of a non return valve in the raw water inlet line, which is under the waterline, this problem can be restricted.

When starting the generator you should always consider when raw water runs out of the exhaust system. If this takes longer than 5 seconds you should replace the impeller pump because it sucks in air for too long before it delivers raw water. The impeller has lost its effect and cannot suck in raw water anymore. This results to an overheating of the motor. If the impeller is not exchanged early enough the impeller blades may break into pieces and plugging the cooling water cycle. It is very important to exchange the impeller after a couple of months.

If the raw water line is too long for the impeller pump or the generator installed too high above the water line a electrical pump can be installed into the raw water line. In this case the impeller should be removed out of the impeller pump.

NOTE:



Contact Fischer Panda for further information.

Never change the impeller for many years, without exchanging the old pump. If the sealing ring is defective within the pump, raw water runs into the sound cover of the genset. A repair is then very expensive.

NOTE:



Replacement impeller and also a spare pump should always be on board. The old pump can be sent back to Fischer Panda for cost-effective repair.

5.4.5 Generator installation below waterline

If the generator cannot be attached at least 600 mm above the waterline, a vent valve must be installed at the raw water line.

Possible heeling must be taken into consideration if installed at the "mid-ship line"! The water hose for the external vent valve is located at the back of the sound insulated capsule. This hose is split in the middle and extended respectively at each end by an additional hose and a connecting nipple. Both hose ends must be led outside of the sound cover, if possible 600 mm over the waterline in the mid-ship line. The valve is connected at the highest place to the two hose ends. If the valve jams the cool water line cannot be de-aerated after stopping the generator, the water column is not discontinued and water can penetrate into the combustion chamber of the engine. This will lead to damage the engine in a short term!

Fig. 5.4.5-1: Vent valve



Fig. 5.4.5-2: Rubber hose for vent valve - example

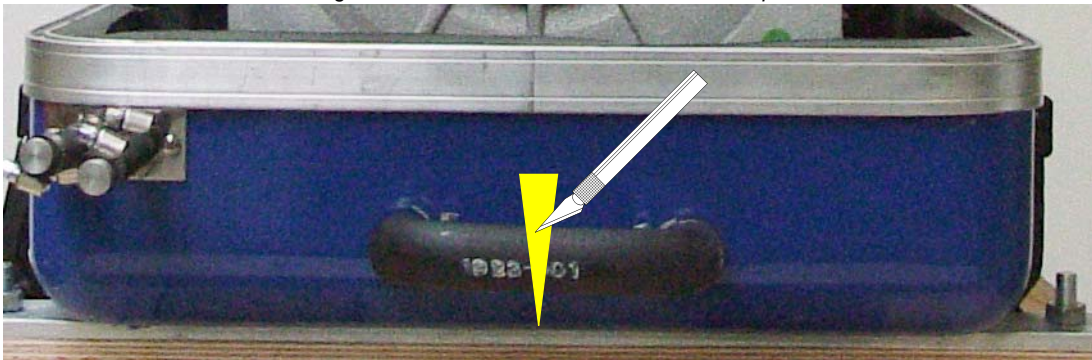

The rubber hose for the external vent valve will be cut...
...and bend upwards.

Both hose ends will be extended respectively with a hose and connected with a vent valve 600 mm over the waterline.

Example

Fig. 5.4.5-3: Split rubber hose for vent valve

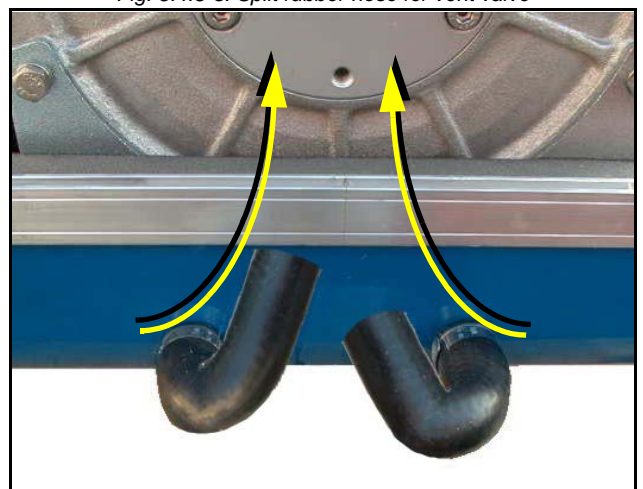

5.4.5.1 Raw water installation scheme

Fig. 5.4.5.1-1: Raw water installation scheme

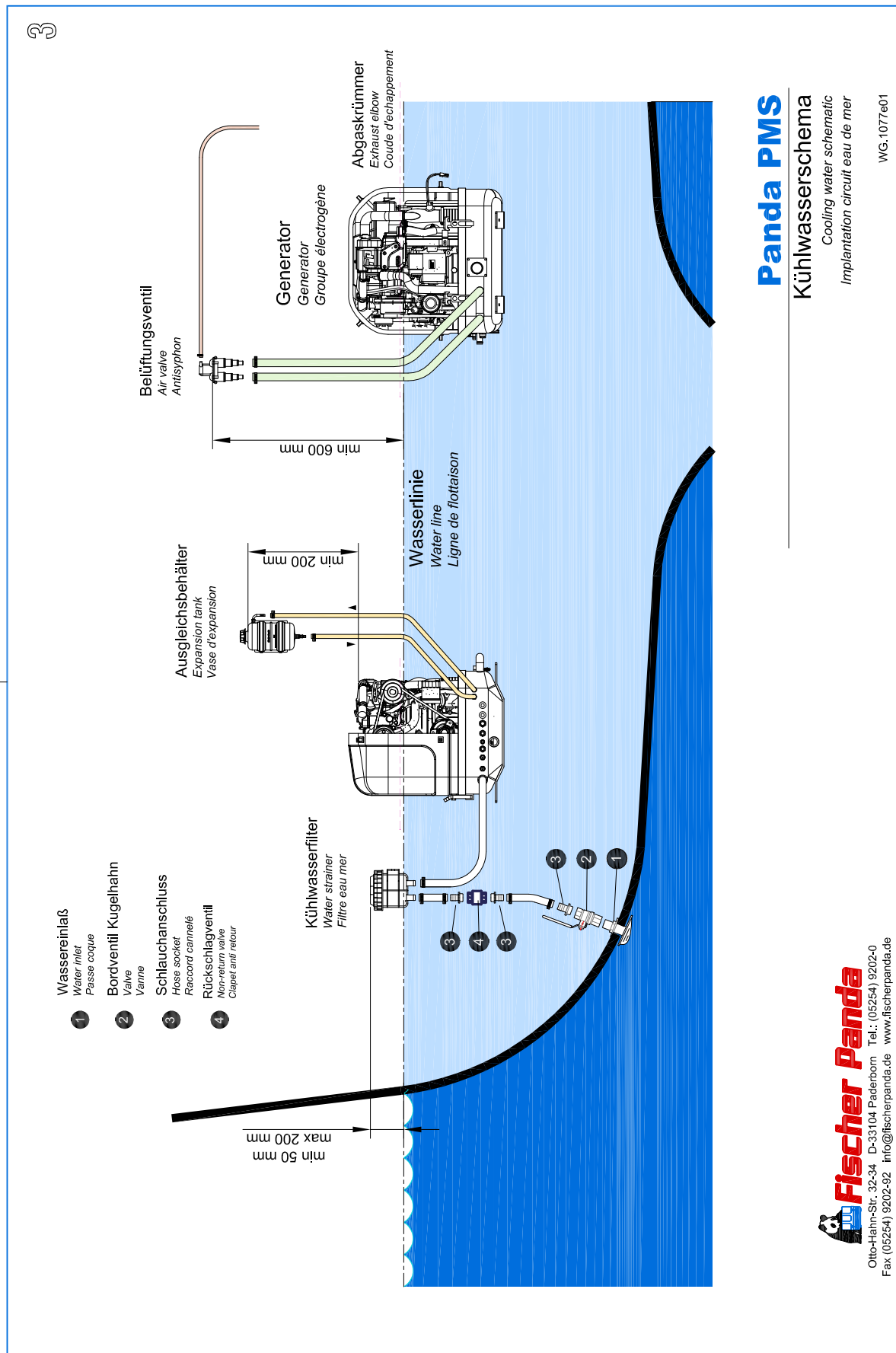

5.5 Installation of the cooling system - fresh water

5.5.1 Position of the external cooling water expansion tank

Position of the external cooling water expansion tank

The Panda generator is normally supplied with an additional, external cooling water expansion tank. This tank must be installed in such a way that its lower edge is at least 200 mm more highly arranged than the highest point of the Generator.

If this 200 mm should be fallen below, i.e. the cooling water expansion tank is lower installed, very large problems can occur with filling and ventilating. Extend and displace the hose lines to the outside or possibly even up to the deck.

Fig. 5.5.1-1: Position of the external cooling water expansion tank

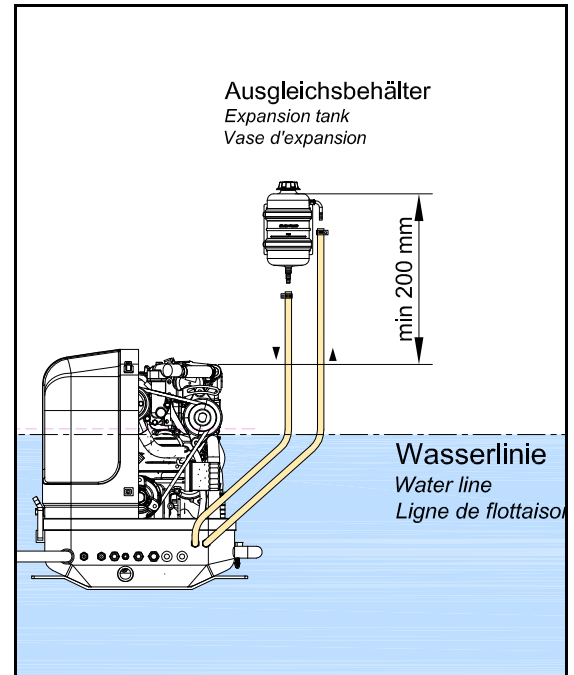

The external cooling water expansion tank may be filled only up to the lower edge of the lower tension tape (see note „max“) in the maximum filling level in cold condition.

ATTENTION!



5.6 Installation of the water cooled exhaust system

5.6.1 Installation of the standard exhaust system

The generator exhaust system must remain completely independent and separate from the exhaust system of any other unit(s) on board. The water lock must be installed at the lowest point of the exhaust system. An optional noise insulated water lock can also be installed. The exhaust hose descends from the capsule to the water lock. Then the hose rises via the „goose neck“ to the silencer (see drawing). The goose neck must be vertical and sit preferably along the ship's keel centre line. In order that the back pressure inside the exhaust is not too high, the total length of the exhaust system should not exceed 6,3 m.

By injecting the outlet raw water into the exhaust manifold, the exhaust gases are cooled and the noise emissions from the exhaust system are reduced.

Exhaust diameter see section 9.10, "Diameter of conduits," on page 119.

Fig. 5.6.1-1: Installation Scheme Standard Exhaust System

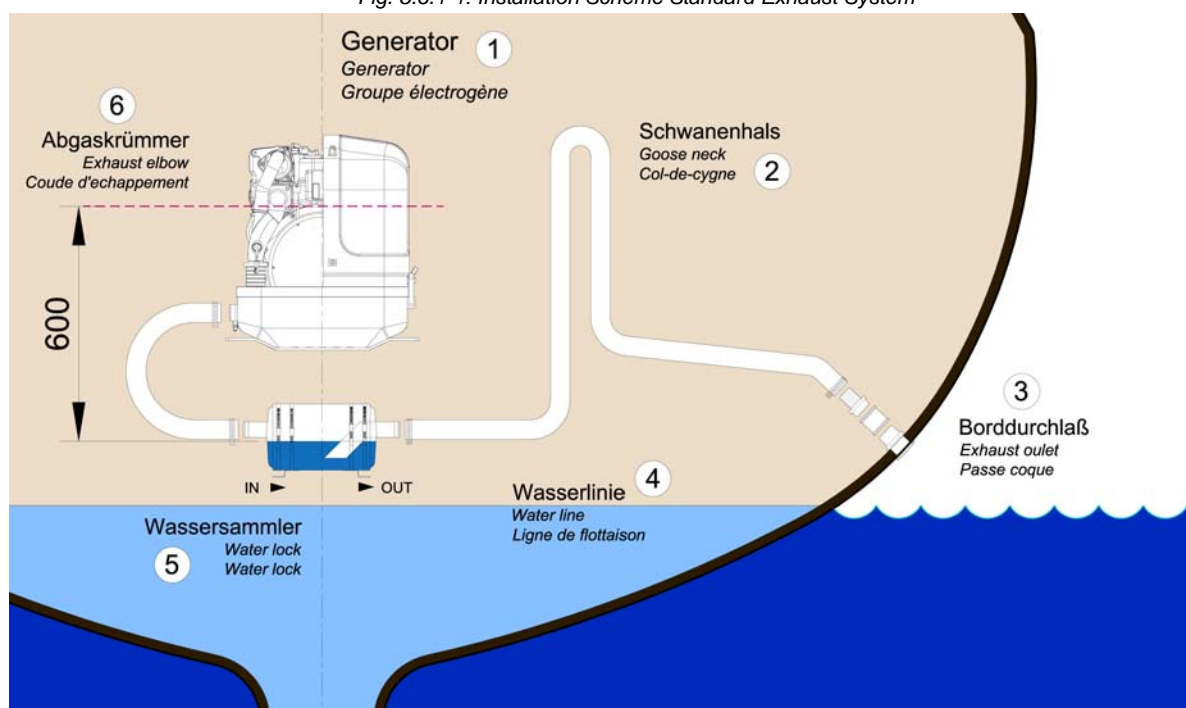

5.7 Installation of the waterlock

Pay attention to the right flow direction through the waterlock.

Note!:



Unfortunately, it can occasionally occur that, because of an disadvantageous mounting position of the waterlock, sea water gets into the diesel engines' combustion chamber. This disables the diesel engine by irreversible damages. Quite frequently, this leads to discussions during which the parties involved in the yachts' construction or the installation of the generator have to explain themselves.

One point in this situation can be clarified definitely:

If sea water gets into the inner section of the engine, this is not possible due to constructional defects of the generator or to malfunctions on the engine itself. It can only reach the combustion chamber via the exhaust hose and thus get into the engine.

Thereby, the position of the generator and the waterlock, as well as the arrangement of the cooling water and exhaust hoses play the decisive role.

If the waterlock is arranged in an unfavourable position, the cooling water flowing back in the exhaust hose can rise so high, that it reaches the exhaust stack. Since at least one discharge valve is always open when the engine is shut off, the sea water has free access to the combustion chamber. By capillary action, this sea water then flows past the cocks and even reaches the engine oil in that way. (In fact, a surprisingly high oil level is a first indication of an upcoming catastrophe).

If an usual high oil level can be detected and/or the oil is of a greyish colour, the engine must not be used anymore. This is a certain sign for cooling water that got into the oil pan. If the engine is started under these conditions, the water and the oil are mixed into an emulsion. The oil will quickly become so viscous that one will have to call it a paste. In this phase the fine oil hoses are blocked and a few moments later the machine gets destroyed because of insufficient lubrication. Before this happens, an immediate oil change should be made. Since the water can only reach the engine via the combustion chamber, it can be assumed that the compression rings will start to corrode. These effects have to be discussed with an engine expert. It will certainly be reasonable to immediately inject plenty penetrating oil through the intake stack and to slowly turn the engine with the starter motor.

The cooling water can reach the exhaust area via the exhaust hose as well as via the cooling water feed.

5.7.1 Possible cause for water in the exhaust hose

5.7.1.1 Possible cause: exhaust hose

If the cause is the exhaust hose itself, the following points are to be checked at the hose:

- a) Position of the waterlock is too high. The water reaches the exhaust hose.
- b) Position of the waterlock is too far away from the middle of the generator. The water reaches the exhaust hose in tilted position.
- c) The waterlock is too small relating to the length of the exhaust hose.

5.7.1.2 Possible cause: cooling water hose

If the generator is not clearly installed 600 mm over the water line, the cooling water feed must be equipped with a „venting valve“ which is at least led out 600 mm over the water line. (This position must also be assured in every tilted position. Therefore, the venting valve should be located in the ships' center line, so that it cannot move in tilted position).

- a) Position of the venting valve is too low. The water flows into the exhaust area when the ship is tilted.
- b) Position of the venting valve is too far from the ships' center line. The water reaches the exhaust area when the ship is tilted.
- c) The venting valve does not work, because it jams or it is clotted. (The venting valve's function needs to be checked regularly.)

As it consistently happens that functioning risks are not realised during the laying of the exhaust hose, the following explanations refer explicitly to the exhaust hose. Here, the location, the size and the position of the „waterlock“ play a very decisive role:

5.7.2 Installation area of the waterlock

Concerning a water-cooled exhaust system, it must be regarded that - under no circumstances - cooling water from the exhaust hose can get into the exhaust elbow area at the engine. If this happens, the cooling water can get into the combustion chamber via an open discharge valve. This would lead to irreparable damage at the engine.

In addition to that, one has to reckon with possible tilted positions of sailing yachts, which makes the position of the waterlock even more important. In general one could say that:

The deeper the waterlock is located underneath the generator, the better the protection from entering water into the combustion chamber.

The picture below shows that the distance between the critical point at the exhaust elbow and the maximum permissible water level in the exhaust hose is stated with 600 mm. This distance should be understood as a minimum distance.

5.7.3 The volume of the waterlock

The waterlock must be measured so large, that it can take the entire amount of water flowing back from the exhaust hose. The amount of water depends on the hoses' length (L) and its cross section. While the diesel engine is running, cooling water is continuously injected into the exhaust system and is carted outside with the emissions by the exhaust gas pressure. When the engine is turned off, the number of revolutions sinks quite fast. By doing so, the point is reached where the exhaust gas pressure does not suffice anymore to cart the cooling water out. All cooling water remaining in the hose at that point flows back into the waterlock. At the same time, the diesel engine itself continues to cart cooling water through the cooling water pump, as long as it keeps on rotating.

The waterlock must necessarily be measured large enough that it can take the entire amount of cooling water and, at the same time, does not exceed the prescribed vertical height of 600 mm up to the critical point at the exhaust elbow.

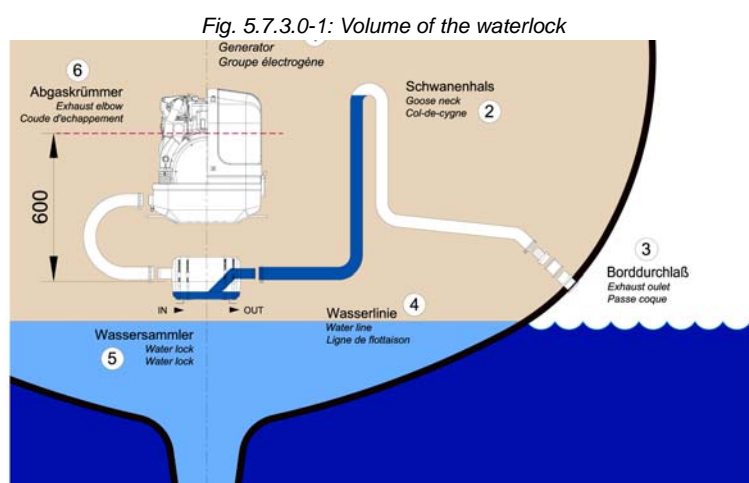

If there are any doubts, a verification can easily be made by temporarily using a clear-sighted hose (1) as exhaust hose. In that way, the cooling water level can be checked very easily.

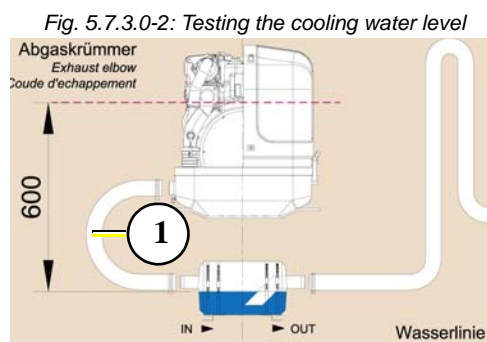

5.7.3.1 Ideal position of the waterlock

Important Note!

The ideal position of the waterlock would be in center underneath the generator. Only in this position it is assured that the water level cannot change drastically in tilted position by the waterlock moving out of the

center line. See the following pictures:

Fig. 5.7.3.1-1: Ideal position of the waterlock

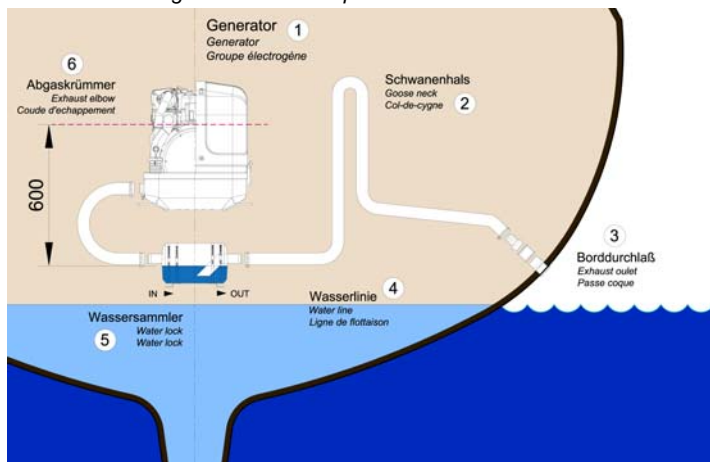

In Fig. 5.7.3.1-1, the waterlock is mounted in center underneath the generator. When the ship tilts, the position of the waterlock related to the critical point at the exhaust hose, changes only slightly.

Fig. 5.7.3.1-2: Tilted position 15 degrees

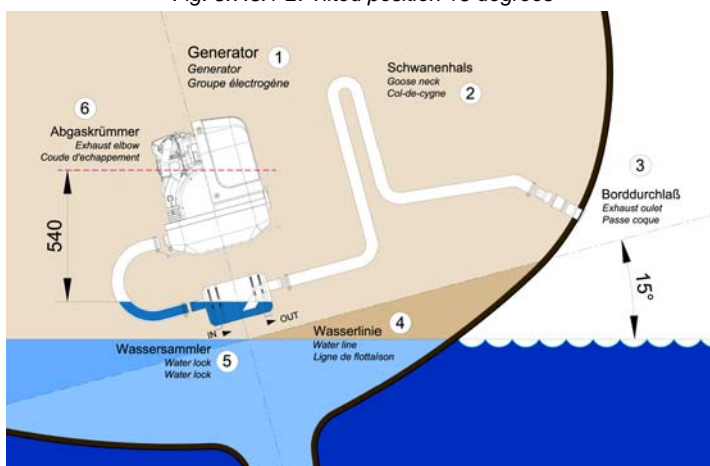

Tilted position 15 degrees - Fig. 5.7.3.1-2

The distance from the exhaust elbow to the hydrostatic head has derated to 540 mm.

Fig. 5.7.3.1-3: Tilted position 30 degrees

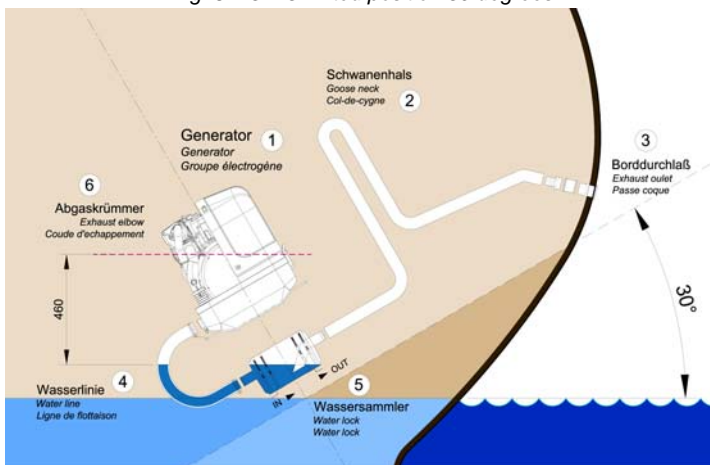

Tilted position 30 degrees - Fig. 5.7.3.1-3

The distance of the water level, even in ideal position, changes that only 458 mm distance remain. So the critical distance is under-run already.

Fig. 5.7.3.1-4: Tilted position 45 degrees

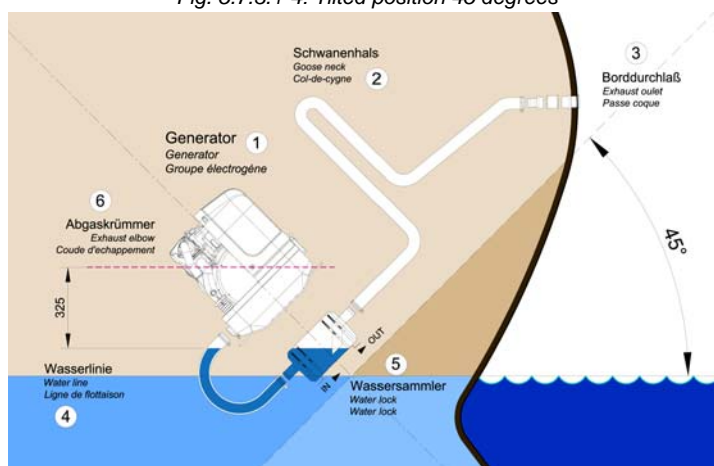

Tilted position 45 degrees - Fig. 5.7.3.1-4

In this case the water level rise so high, that the distance constitutes only 325 mm.

Even when the water lock is mounted in the ideal spot, at an extremely tilted position of 45 degrees there is still the risk that water can get straight into the discharge stack area through strong rocking motions („sloshing“). This shows that the distance of 600 mm represents a minimum size at which, even when installed ideally, the water can slosh into the exhaust elbow when the ship is very tilted or rocks very hard.

Summary:

The preset minimum height of 600 mm must be regarded unconditionally and is only valid if the waterlock is mounted in its ideal position in center underneath the generator. A higher position is highly recommended if it has to be reckoned with tilted positions of 45 degrees.

5.7.3.2 Example of the installation of the waterlock off-center and possible effects:

The following pictures are primarily relevant for an installation of the generator with the waterlock on sailing yachts. A change in the mounting position caused by tilted position does not have to be reckoned concerning motor yachts. Here it is only necessary to regard that the volume of the waterlock is measured so large that it can take the entire amount of water flowing back, and at the same time, maintains the minimum distance of 600 mm.

A) Installation of the waterlock 500 mm next to the generator’s center line:

Fig. 5.7.3.2-1: waterlock, 500 mm next to the center line

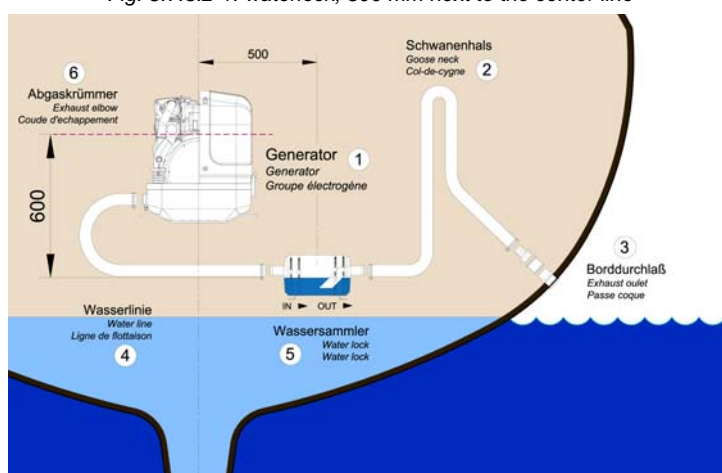

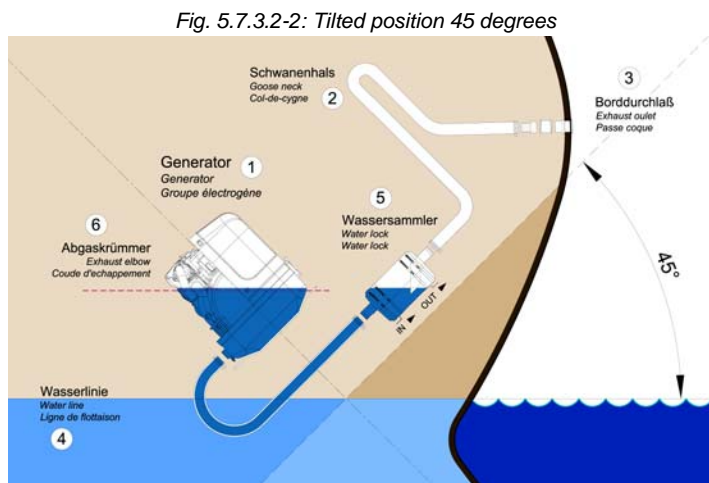

Tilted position 45 degrees - Fig. 5.7.3.2-2

The water level is now at the same height as the critical point at the exhaust elbow. If the ship is sailed in a tilted position of 45 degrees with an installation like this, the ingress of cooling water into the combustion chamber is inevitable. Irreparable damages are pre-programmed.

B) Installation distance between waterlock and the generator's center line 1000 mm

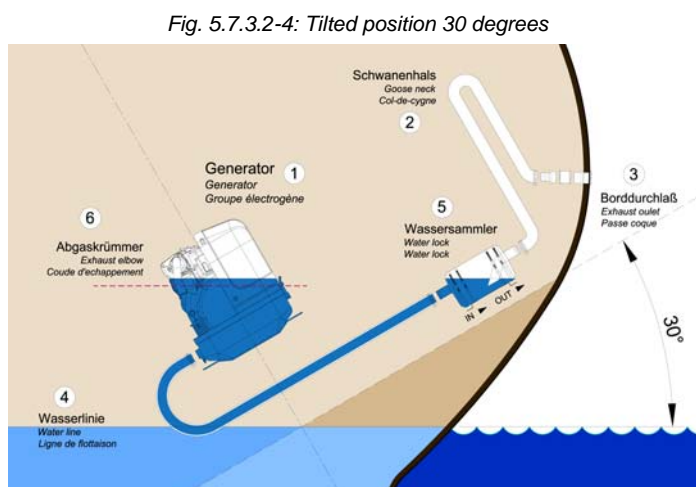
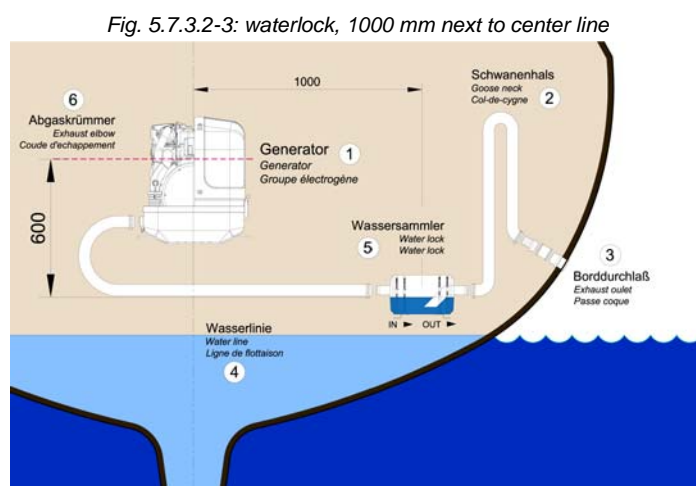

Tilted position 30 degrees - Fig. 5.7.3.2-4

The water level and the critical point at the exhaust elbow are at the same level now. If the ship is sailed in a tilted position of 30 degrees with an installation like that, the infiltration of cooling water into the combustion chamber is inevitable. Irreparable damages are pre-programmed.

Summary:

Concerning sailing yachts it must be regarded, that the waterlock is mounted in center underneath the generator, at least in reference to the ships' center line. Thus the waterlock is prevented from „leaking“ very strongly when the ship is tilted.

The „leaking“ of the waterlock leads to a rise of the water level which then gets too close to the exhaust elbow's critical point.

5.8 Exhaust / water separator

In order to reduce the noise level of the generator unit to a minimum, an optional exhaust outlet muffler can be mounted next to the through-hull fitting. Additionally there is a component at Fischer Panda, which acts as both an „exhaust goose neck“, and water separator. With this „exhaust/water separator“ the cooling water is derived over a separate pipe. The exhaust noises emanating from the exterior of the yacht are strongly decreased. Particularly the „water splash“.

Fig. 5.8.0-1: Installation Scheme exhaust / water separator

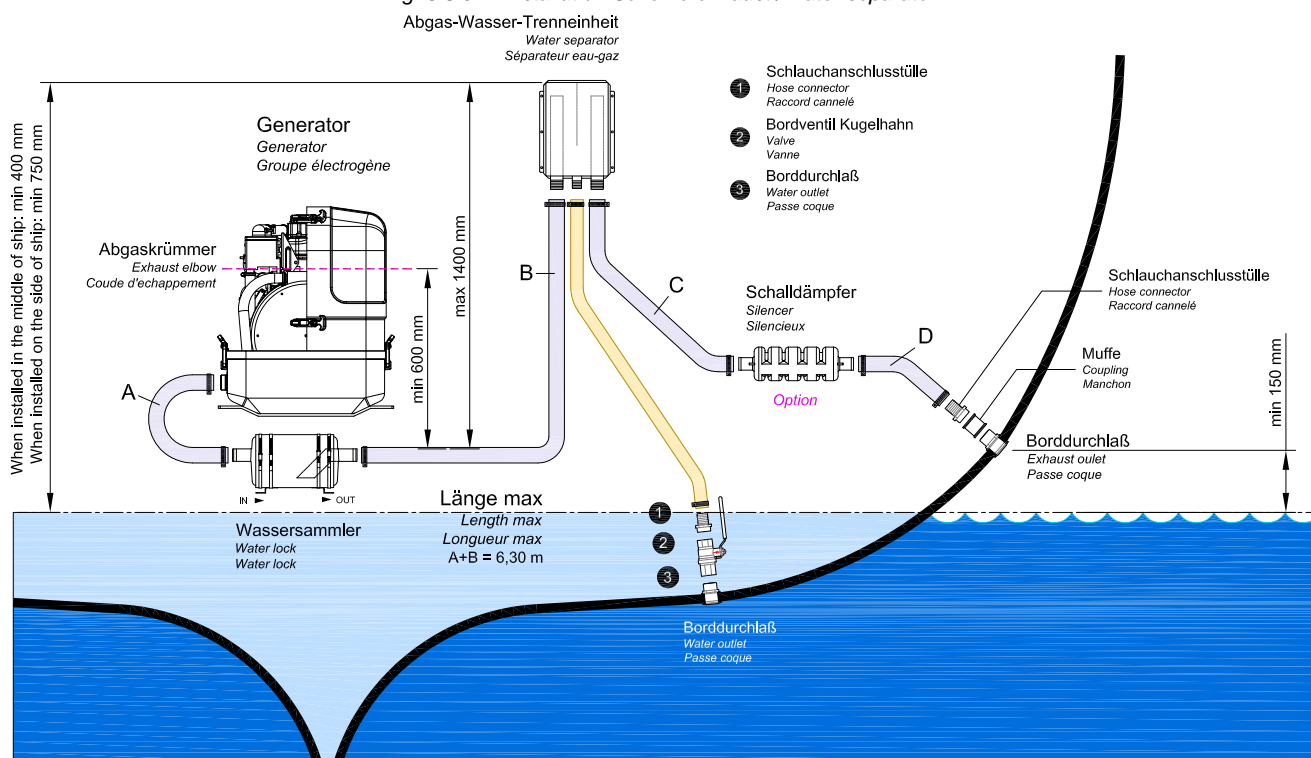

5.9 Installation exhaust water separator

If the exhaust water separator was sufficiently highly installed, a goose neck is no longer necessary. The exhaust/water separator fulfils the same function. If the „Super silent“ exhaust system were installed correctly, the generator will not disturb your boat neighbour. The exhaust noise should be nearly inaudible. The best result is reached, if the hose line, which derive the cooling water, is relocate on a short way „falling“ directly to the outlet and this outlet is under the waterline.

If the through-hull exhaust outlet has to be mounted far from the generator, an exhaust-water separator must definitely be installed. The raw water from the separator must then run along the shortest possible path in the through-hull outlet. For such long exhaust routes, the exhaust hose diameter should also be increased, f.e. from NW40mm to NW50mm in order to reduce the back-pressure. The exhaust may have a length of over 10 m (32 ft.) if the exhaust hose diameter is increased. An additional outlet exhaust muffler close to the hull outlet will help further to reduce noise emissions.

The generator will not disturb your boat neighbours, if the „Super silent exhaust system has been correctly installed.

The exhaust noise should be almost inaudible.

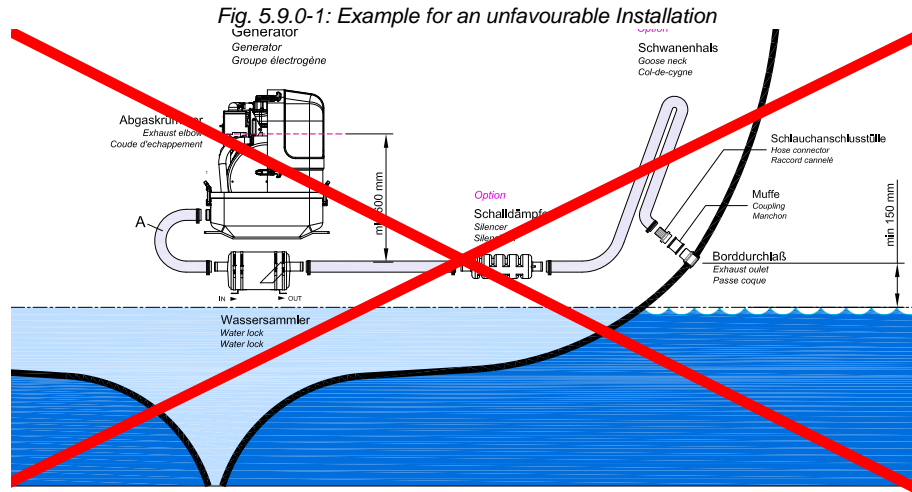

Example of an unfavourable installation:

- Water lock not far enough below the lowest level of the generator
- Distance water lock to gooseneck too large

5.10 Fuel system installation

Fig. 5.10.0-1: Fuel system - schema

Achtung:

Kraftstoffpumpe so tief wie möglich installieren
 maximale Saughöhe der Pumpe beträgt: 500mm
 maximale Förderhöhe der Pumpe beträgt: 2500mm

Note:

Fuel pump installed as deep as possible
 maximum suction lift of the pump is: 500mm
 maximum pump head is: 2500mm

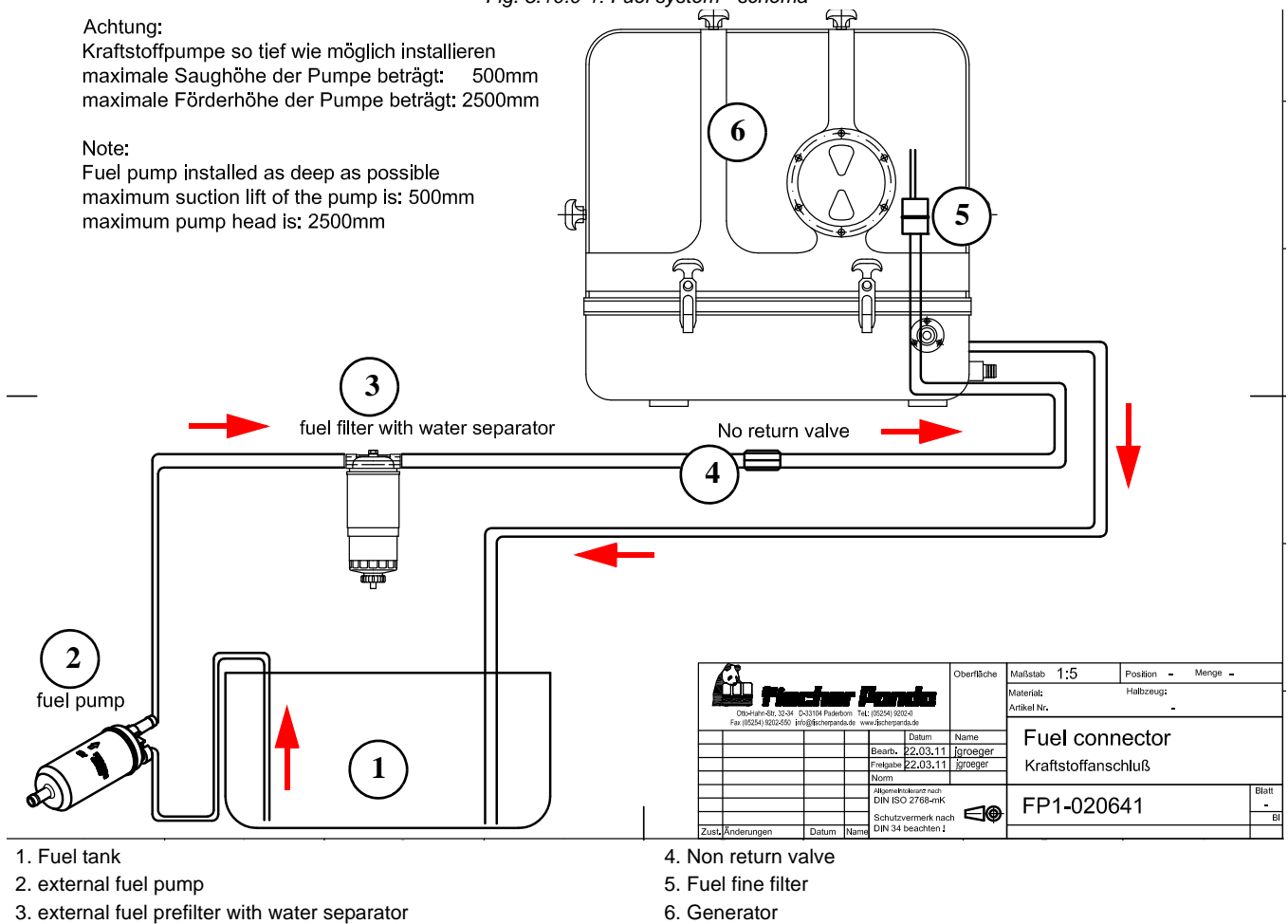

1. Fuel tank
2. external fuel pump
3. external fuel prefilter with water separator

4. Non return valve
5. Fuel fine filter
6. Generator

<p>Otto-Hahn-Str. 32/34 D-33194 Pralognan Tel.: 052541 9020-0 Fax: 052541 9020-550 E-Mail: info@fischerpanda.de www.fischerpanda.de</p>		Oberfläche	Maßstab 1:5	Position -	Menge -																								
		Material: Halbzeug		Artikel Nr. -																									
<table border="1"> <tr> <th>Bearb.</th> <th>Datum</th> <th>Name</th> </tr> <tr> <td>igroeger</td> <td>22.03.11</td> <td>igroeger</td> </tr> <tr> <th>Freigebe</th> <th>Datum</th> <th>Name</th> </tr> <tr> <td>igroeger</td> <td>22.03.11</td> <td>igroeger</td> </tr> <tr> <th colspan="3">Norm</th> </tr> <tr> <td colspan="3">Allgemeinzeichnung nach DIN ISO 2768-mk</td> </tr> <tr> <th colspan="3">Schutzvermerk nach DIN 34 beachten!</th> </tr> <tr> <td>Zust.</td> <td>Änderungen</td> <td>Datum</td> <td>Name</td> </tr> </table>		Bearb.	Datum	Name	igroeger	22.03.11	igroeger	Freigebe	Datum	Name	igroeger	22.03.11	igroeger	Norm			Allgemeinzeichnung nach DIN ISO 2768-mk			Schutzvermerk nach DIN 34 beachten!			Zust.	Änderungen	Datum	Name	Fuel connector Kraftstoffanschluß		Blatt -
Bearb.	Datum	Name																											
igroeger	22.03.11	igroeger																											
Freigebe	Datum	Name																											
igroeger	22.03.11	igroeger																											
Norm																													
Allgemeinzeichnung nach DIN ISO 2768-mk																													
Schutzvermerk nach DIN 34 beachten!																													
Zust.	Änderungen	Datum	Name																										
		FP1-020641		BI																									

External fine filter

At generators with Kubota EA 300 or Farymann engines, the fine filter is delivered with the generator. This fine filter should be installed in the fuel feed line next to the generator.

representative picture

Fig. 5.10-2: externer Feinfilter



5.10.1 Connection of the fuel lines at the tank

General fuel feed and return line must be connected to the tank at separate connection points.

Note:



Connection of the return pipe to the tank

The return pipe connected to the tank must be dropped to the same depth as the suction pipe, if the generator is mounted higher than the tank, in order to prevent fuel running back into the tank after the motor has been switched off, which can lead to enormous problems, if the generator is switched off for a long period.

Non-return valve in the suction pipe

A non-return valve must be fitted to the suction pipe, which prevents the fuel flowing back after the generator has been switched off, if it is not possible to use the return flow pipe as a submerge pipe placed in the tank. The instructions „Bleeding Air from the Fuel System“ must be read after initial operation or after it has stood still for a long period, in order to preserve the starter battery.

Non-return valve for the fuel return pipe

If the fuel tank should be installed over the level of the generator (e.g. daily tank), then a non-return valve must be installed into the fuel return pipe to guarantee that through the return pipe no fuel is led into the injection pump.

ATTENTION!



5.10.2 Position of the pre-filter with water separator

Inside the generator capsule itself, there is the fuel filter installed (exception: Panda 4500). Additional fuel filters (with water separator) must be mounted outside the capsule in easily accessible places in the fuel lines between the tank intake fuel pump and the diesel motor's fuel pump.

Additionally to the standard fine filter a pre-filter with water separator must be installed outside of the sound insulation capsule in the fuel system line (not included in the delivery).

representative picture

Fig. 5.10.2-1: Pre-filter with water separator



5.11 Generator DC system installation

The Panda 5000i has no DC alternator to charge the Starter battery. The Starterbattery must be charged by an external device.

Note:



It is recommended to install an additional starter battery for the generator.

The generator is then independent from the remaining battery set. This enables you to start the genset at any time with its own starter battery even if the other batteries are discharged. A further advantage of a separate starter battery is that it isolates the generator's electric system from the rest of the boat's DC system, i.e. minus pole (-) is not connected electrically to Earth/Ground.

The generator is then Earth/Ground free.

5.11.1 Connection of the starter battery block

An own separate starter battery must be installed for the generator.

The positive cable (+) of the battery is attached directly at the solenoid switch of the starter motor (position 1). The negative cable (-) of the battery is attached underneath the starter motor at the engine mount (position 2).

Panda Generators Panda 6000 and higher normally provided with an alternator/dynamo to charge the starter battery. At generators without alternator/dynamo it is needed to charge the starter battery with an external battery charger.

NOTE:



Make sure that the voltage of the starter battery fits to the start system voltage

ATTENTION!



f.e. 12 V starter battery for a 12 V start system

f.e. 24 V starter battery for a 24 V start system (2x12 V batteries in a row)

To avoid large voltage drops the battery should be installed as near as possible to the generator. The positive terminal of the battery is attached at the red cable, the negative pole at the blue cable.

NOTE:



It must be guaranteed that first the cables are attached at the generator and then at the battery.

Attention!: Consider correct connection sequence



Battery connection

Attention!: Right connection of the battery.

Wrong connection of the battery bank can cause a short-circuit and fire.



Install an appropriate fuse and a battery circuit breaker in the plus pole cable of the battery, but with a distance to the battery of up to 300 mm (12 inch) at maximum.

The cable from the battery to the safety device must be secured with protective pipe/sleeve against chafing through.

For the connection use self-extinguishing and fire-protected cables, which are appropriate for temperatures up to 90 °C, 195 °F.

The batteries must be installed in such a way that they do not chafe through or other mechanical load can be stripped.

The battery poles must be secured against unintentional short-circuit.

The positive battery cable within the generator must be shifted in such a way that it is protected against heat and vibrations by appropriate sleeve/protective pipe. It must be shifted in such a way that it does not affect rotary parts or parts, that become hot in operation, e.g. wheel, exhaust elbow union, tail pipe and the engine. Do not lay the cable too tautly, since otherwise it could be damaged.

Make a test run after the installation and check the laying of the batteries during the test run and afterwards. If necessary, correct the laying.

Examine regularly the cable laying and the electrical connections.

Positive battery cable

The positive (+) battery cable is connected directly to the solenoid switch of the starter.

Fig. 5.11.1-1: Positive Battery Cable

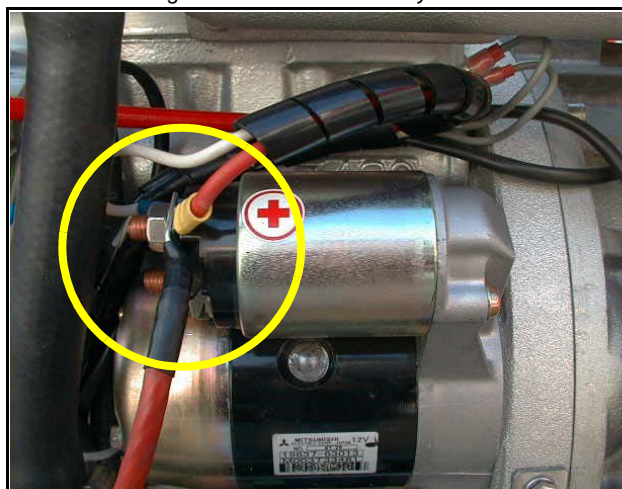

Negative battery cable

The negative (-) battery cable is connected to the engine foot.

Note! The battery negative pole may not be connected with the boat ground or with the protective grounding of the 120 V installation!

Fig. 5.11.1-2: Negative Battery Cable



DC Starter Motor

All Panda generators are equipped with an independent DC starter motor.

1. Solenoid switch for starter motor
2. Starter motor

Fig. 5.11.1-3: DC Starter Motor

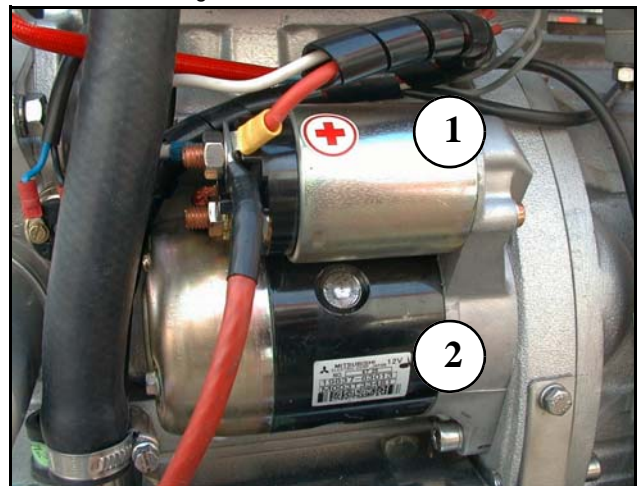
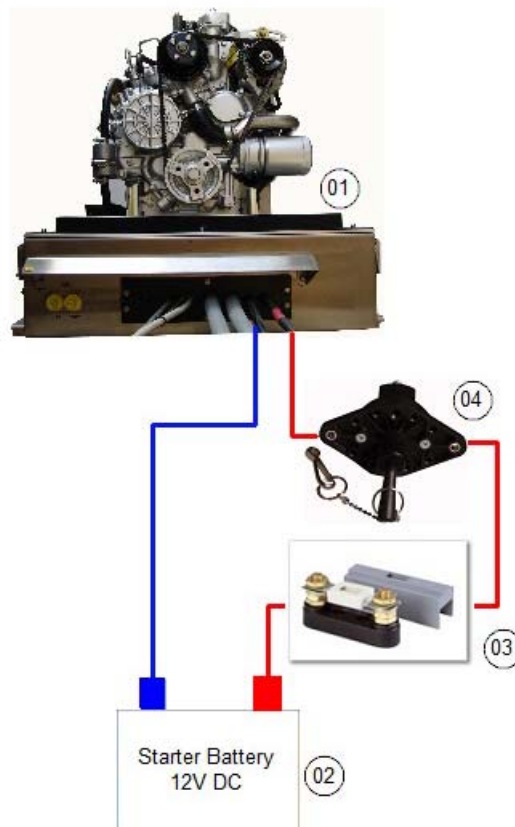

Fig. 5.11.1-4: Connection starterbattery 12V - schema



1. Generator
2. Battery block

3. Fuse
4. Battery main switch

Fig. 5.11.1-5: Connection starterbattery 24V - schema

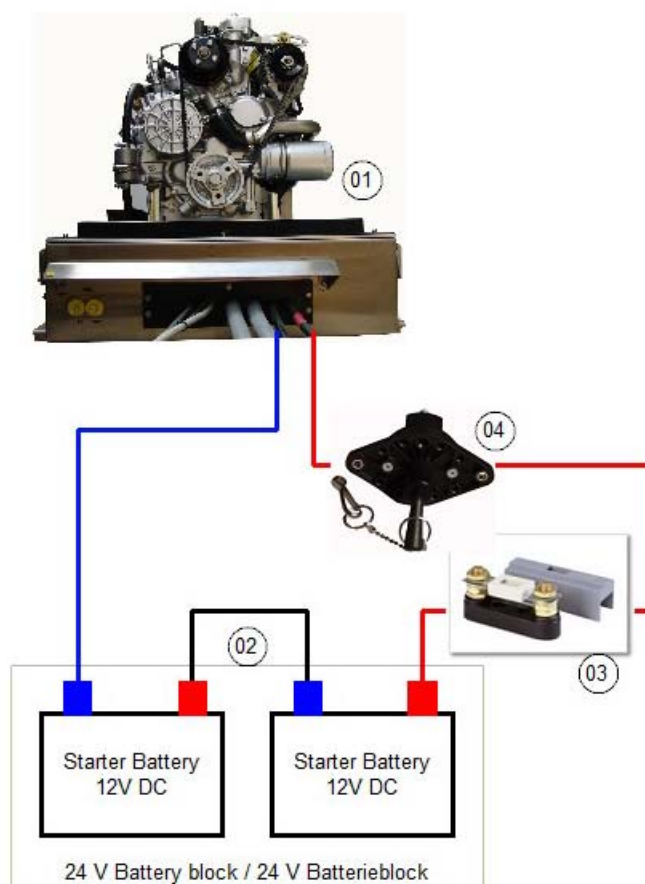

1. Generator
2. Battery block

3. Fuse
4. Battery main switch

5.11.2 Connection of the remote control panel - See Panda iControl panel manual

5.12 Generator AC system installation

Before the electrical system is installed, READ the **SAFETY INSTRUCTIONS** of this manual **FIRST!** Be sure that all electrical installations (including all safety systems) comply with all required regulations of the regional authorities. This includes lightning conductor, personal protection switch etc.

ATTENTION!: Danger to Life - High voltage



All electrical safety installations have to be made on board.

Required cable cross-sections

The recommended electrical cable dimensions (cross sections) are the minimum required sizes for a safe installation. (see section 9.2, "Technical data," on page 107)

Fig. 5.12.0-1: Electrical installation - example

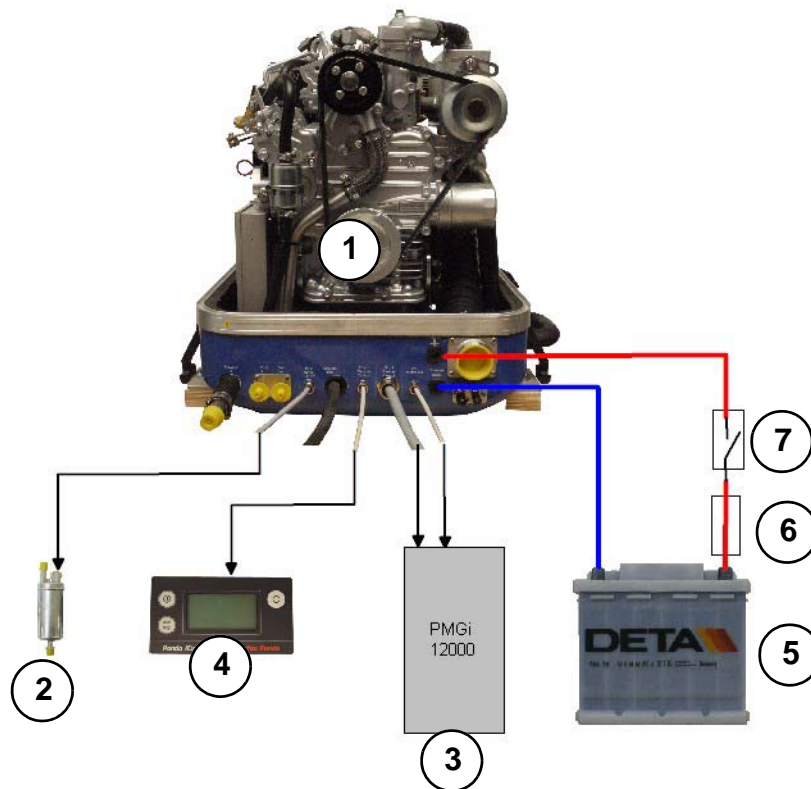

- 1. Generator
- 2. Electrical fuel pump DC
- 3. PMGi inverter
- 4. iControl panel

- 5. Starter battery DC
- 6. Fuse
- 7. Battery switch

5.12.1 Installation PMGi inverter - See separate PMGi inverter manual

6. Generator operation instruction

6.1 Personal requirements

Only instructed persons are allowed to run the generator. Instructed Persons has read the manual of the generator and all ancillary components and external equipment. He must be acquaint with the specific risks and safety instructions.

Only persons who are expected to perform their tasks reliably are permitted as personnel. Persons whose reaction capability is impaired, e.g. through drugs, alcohol or medication are not permitted.

When selecting the personnel, the stipulations regarding age and occupation applying at the location must be observed.

6.2 Hazard notes for the operation

Please note the safety first instructions in front of this manual.

Notice!:



Danger for life! - The generator can be equipped with a automatic start device. This means the generator can be started by an external signal.

Warning!: Automatic start



To avoid an unexpected starting of the generator, the starter battery must be disconnected before start working at the generator.

Rotating parts inside of the generator

Attention!: Danger to life



Do not run the generator with removed sound cover. If it is necessary to test the generator without sound cover, pay special attention. Never do this work alone. Do all service, maintenance and repair with engine stopped.

Danger for Life. Improper handling, operation, installation and maintenance can result in severe personal injury and/or material damage.

Attention!: Danger to Life - High voltage



Electrical voltages above 48 volts (battery chargers greater than 36 volts) are always dangerous to life). The rules of the respective regional authority must be adhered to. Only an electrician may carry out installation of the electrical connections for safety reasons.

6.3 General operating instruction

6.3.1 Operation at low temperatures

The Generator can be started at temperatures down to - 20 °C, therefor the operation fluids like fuel, cooling water, lubricant oil ect. must be suitable for this temperatures. These should be checked before start. Cold start spray ect. are not allowed to use, or the warranty will be lost.

6.3.1.1 Pre-heating the diesel motor

Pre-chamber diesel engines are equipped with a quick glow plug. The maximum pre glow time should not exceed 20 sec. At 20 °C or more the pre glow time should be about 5-6 sec. Below 20 °C the pre glow time should be increased,

If the operation fluids have been drained and then filled with cold weather fluids, always run the generator for 10 minutes to ensure the new fuel is present throughout the system. **Note:**



6.3.1.2 Tips regarding starter battery

Fischer Panda recommends normal starter battery use. If a genset is required for extreme winter conditions, then the starter battery capacity should be doubled. It is recommended that the starter battery be regularly charged by a suitable battery-charging device (i.e., at least every 2 Months). A correctly charged starter battery is necessary for low temperatures.

6.3.2 Light load operation and engine idle

If an engine is operated on a load less than 25-30 % of its rated output, the soot of the generator will be observed which may give cause for concern. The usual results of this operation are heavier than normal lubricating oil consumption, and oil leaks from the air and exhaust manifolds. This condition is particularly evident on standby generator set applications.

6.3.2.1 The soot of the generator is due to the fact that:

The cylinder temperatures are too low to ensure complete burning of all the fuel delivered.

A further result is that of abnormal carbon build-up on the valves, piston crowns and exhaust ports. Fuel dilution of the lubricating oil will also occur.

6.3.2.2 To prevent the soot of the generator following steps should be observed:

Running on light load should be avoided or reduced to the minimum period.

In a period of 50 operation hours the engine or generator set should be run on full load for four hours, to burn off accumulations of carbon in the engine and exhaust system. This may require the use of a 'dummy load'. The load should be built up gradually from 30 % to 100 % within 3 hours and hold at 100 % for one hour.

6.3.3 Generator load for a longer period and overload

Ensure the generator is not overloaded. Overloading occurs when the electrical load is higher than the generator can provide. If this occur for a longer period, the engine may be damaged. Overloading may cause rough running, high oil and fuel consumption, increased emissions.

For a long engine life, the long term load should not exceed 80 % of the nominal load. Long term load is the load over several hours. It is harmless for the generator to deliver full nominal power for 2-3 hours.

The whole conception of the Fischer Panda generator make sure, that the full power operation at extreme condition will not increase the engine temperatures over. Please note that the emissions of the generator also increase at full power operation.

6.3.4 Protection conductor:

The standard Panda generator is grounded. The 3-phase connection (delta) centre point is bridged to earth in the AC output terminal box (mounted on the generator). This is the initial earth safety point and is sufficient to ensure safe operation however only as long as no other system is installed. This system is adapted to enable test running of the generator before delivery.

The bridge to ground (PEN) is only effective when all components in the electrical system share a common ground. The bridge to ground can be removed and reconnected to another ground system if required for other safety standards.

Full voltage connections are mounted in the electrical cabinet. It must be ensured that the electrical cabinet is secured and closed while the generator is running.

The starter battery cable should be disconnected when work is being done on either the generator or the electrical system in order to prevent accidental starting of the generator.

6.3.5 Operating control system on the Fischer Panda generator

Fischer Panda generators are equipped with various sensors/temperatures switches. The combustion engine is further equipped with a oil pressure control switch, which switches the motor off, if the oil pressure sinks to a particular level.

6.4 Instructions for capacitors - not present at all models

Danger to Life - High voltage

CAUTION!

Do not touch the capacitor contact terminals!



The generator's electrical system requires two different groups of capacitors:

- A) The booster capacitors
- B) The operating capacitors

Both types are mounted in the electrical cabinet. (At some models direct on the generator)

Capacitors store an electrical charge. It is possible that even after they have been disconnected stored energy is still held. Therefore it is essential that the connectors are not touched.

Should it be necessary to check or test the capacitors, they should be shorted out by using an insulated screw driver.

The operating capacitors are automatically discharged when the generator is stopped in the normal way. The booster capacitors will be discharged through internal resistors.

For safety however, the capacitors have to be discharged (short circuited) prior to carrying out any work on the AC-Control box.

6.5 Checks before start, starting and stopping the generator

see remote control panel data sheet/manual

The instructions and regulations of the remote control panel data sheet/manual must be respected. **Note:**

Respect the safety instruction in front of this manual.



6.6 Optional Electromagnetic Clutch

The activation of the electromagnetic clutch will be monitored by the iconcontrol control unit. The iconcontrol control unit will raise the generator from variable to top speed. the parallel operation is still active and the load balancing will work in limited range.

7. Maintenance Instructions

7.1 Personal requirements

All maintenance, if not special marked, can be done by the trained persons.

Further maintenance must be done by technical personal or Fischer Panda service points.

7.2 Hazard notes for the maintenance and failure

Follow the general safety instruction at the front of this manual.

Notice!



Danger for life! - The generator can be equipped with a automatic start device. This means the generator can be started by an external signal. To avoid an unexpected starting of the generator, the starter battery must be disconnected before start working at the generator.

Warning!: Automatic start



Working at a running generator can result in severe personal injury. Therefore before starting work at the generator:

Warning!: Risk of injury



Make sure that the generator is stopped and the starter battery is disconnected to guarantee that the generator cannot be inadvertently started.

Do not run the generator with removed sound isolation cover

Improper installation/maintenance can result in severe personal injuries or material damage.

Warning!: Risk of injury



- Always undertake installation/maintenance work when the generator is switched off.
- Ensure there is sufficient installation clearance before start working.
- Ensure tidiness and cleanliness at the workplace. Loose components and tools lying around or on top of each other are sources of accidents.
- Only perform installation work using commercially available tools and special tools. incorrect or damaged tools can result injuries.

Oil and fuel vapours can ignite on contact with ignition sources. Therefore:

Warning!: Danger of fire



- No open flames during work on the generator.
- Do not smoke.
- Remove oil and fuel residues from the generator and floor.

Contact with engine oil, antifreeze and fuel can result in damage to health. Therefor:

- Avoid skin contact with engine oil, fuel and antifreeze.
- Remove oil and fuel splashes and antifreeze from the skin immediately.
- Do not inhale oil and fuel vapours.

Danger for Life. Improper handling, operation, installation and maintenance can result in severe personal injury and/or material damage.

Electrical voltages above 60 volts are always dangerous to life). The rules of the respective regional authority must be adhered to. Only an electrician may carry out installation of the electrical connections for safety reasons.

Generator, oil and antifreeze can be hot during/after operation. Risk of severe burns.

During Installation/maintenance personal protective equipment is required to minimize the health hazards.

- Protective clothing
- safety boots
- protective gloves
- Ear defender
- safety glasses

Disconnect all load during the work at the generator to avoid damages at the load.

Batteries contains acid or alkalis.

Improper handling can result in battery explosion and leakage. Acid or alkalis can run out. An explosion of the battery is possible.

See the operation and safety instruction from your battery manufacturer.

Batteries contain corrosive acids and lyes.

Improper handling can cause the batteries to heat up and burst. Corrosive acid/lye may leak. Under unfavorable conditions, the battery may explode.

Observe the instructions from your battery manufacturer.

Danger!: Danger of poisoning



ATTENTION!: Danger to Life - High voltage



Warning!: Hot surface/material



Instruction!: Personal protective equipment necessary.



Attention!: disconnect all load



Warning!:



7.3 Environmental protection

Danger to the environment due to mishandling!

Significant environmental damage can occur, particularly for incorrect disposal, if environmentally hazardous operating materials are mishandled. Therefore:

- Always observe the instructions mentioned below.
- Take immediate action if environmentally hazardous materials reach the environment. Inform the responsible local authorities about the damage in the case of doubt.

The disposal must be performed by a specialist disposal company.

Environmental protection.



7.4 Maintenance Requirements

Control before starting

- Oil level
- Cooling system leaks
- Visual check for any changes, leaks oil drain system, v-belt, cable connections, hose clips, air filter, fuel lines

Once a week

- Lubrication of actuator-trapezoid thread spindle

7.5 Maintenance interval

For the maintenance intervals, see the „General information for vehicles generators“ which are attached to this manual.

For generators with dynamic maintenance interval (for example generators with iControl2). Further informations are in the remote control panel manual/data sheet.

With the dynamic operation hours the service interval can be raised up to 30% (200h max.). Make sure that the dynamic operation hours are not reset accidentally between the service interval.

Note:



7.5.1 Check of hoses and rubber parts in the sound insulated capsule

Check all hoses and hose connections for good condition. The rubber hoses are very sensitive to environmental influences. They wear quickly in an environment of dry air, oil and fuel vapours, and high temperatures. The hoses must be checked regularly for elasticity. There are operating situations, when hoses must be renewed once a year.

7.6 Checking oil-level

You require:

paper towels / cloth for the oil dipstick

The generator must be placed at level.

- with vehicular generators: Place the vehicle on a levelled surface.
- with PSC generators: Place the generator on a levelled surface.
- with marine generators: Measure the oil-level when the ship is not lop-sided.

Run the generator for about 10 minutes to ensure that the engine is warm. Wait for 3 minutes, so the oil can flow back into the oil pan.

Generator and coolant can be hot during and after operating.

Wear personal protective equipment. (Gloves, protective goggles, protective clothing and safety shoes)

- Assure generator against accidental start.
- Open the generator casing.
- Pull the oil dipstick out of the check rail.
- Clean oil dipstick.
- Put the oil dipstick back into the check rail and wait for 10 seconds.
- Pull the oil dipstick out of the check rail and read off the oil-level at the lower end of the stick.

Caution: Burn hazard!



Oil dipstick

The oil-level is to be checked by means of the oil dipstick. The prescribed filling level must not cross the „Max“-mark.

We recommend an oil-level of 2/3.

Sample picture

Fig. 7.6-1: Oil dipstick - Sample

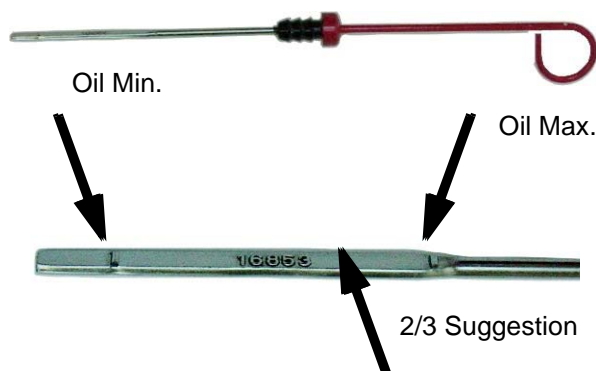

Oil dipstick EA 300 Engine

The oil-level is to be checked by means of the oil dipstick. The prescribed filling level must not cross the „Max“-mark.

We recommend an oil-level of 2/3.

Sample picture

Fig. 7.6-2: Oil dipstick



Oil should be refilled, if the oil-level is under 1/3 between the minimum and the maximum mark.

Fischer Panda recommends an oil-level of 2/3 between the minimum and the maximum mark.

If the oil-level is under the MIN-mark, check how many operating hours went by since the last oil change, by means of your service manual or an existing oil change tag. - with operating hours between 50 and 150 hours it is only

necessary to refill oil. See „Refilling oil“ on page 2.

- with 150 operating hours or more the oil should be changed (See your generators' service table)
- if the oil-level is under the minimum mark by less than 50h, there might be a technical problem! In that case, we recommend going to a shop or a Fischer Panda service point.
- if the oil is cloudy or even „creamy“, coolant might have mixed with the oil. See a garage or a Fischer Panda service point immediately.

7.6.1 Refilling oil

You require:

Engine oil

1. Check oil-level as described under section 7.6, “Checking oil-level,” on page 77.
2. Oil dipstick is pulled out of the check rail.
3. Open the oil filler cap.
4. Fill in oil (approx. 1/2 litre) and wait for about 2 min. so this it can flow into the oil pan.
5. Wipe off the oil dipstick and put it into the check rail.
6. Pull the oil dipstick out of the check rail and check the oil-level. See section 7.6, “Checking oil-level,” on page 77.

If oil-level is still too low (under 2/3): repeat steps 4-6.

7.6.2 After the oil level check and refilling the oil

- Put the oil dipstick back into the check rail.
- Close the oil filling cap.
- Remove potential oil stains and splashes from the generator and surroundings.
- Close the generator casing.
- Remove lock against accidental generator start.

7.7 Replacement of engine oil and engine oil filter

You require:

- Engine oil. See attachment.
- New oil filter (not with generators with EA300 engines)
- Sealing for oil drain screw
- Personal protective gear
- Container to collect used oil (heat resistant and of sufficient size)
- Open-ended wrench for oil drain screw
- Paper towels and cloth
- Oil filter wrench
- Oil resistant mat, so prevent used oil from getting into underground water

The generator must be placed at level.

- with vehicular generators: Place the vehicle on a levelled surface.
- with PSC generators: Place the generator on a levelled surface.
- with marine generators: Change the oil when the ship is not lop-sided.

Run the generator for about 10 minutes to ensure that the engine is warm.

Wait for 3 minutes, so the oil can flow back into the oil pan.

Generator and coolant can be hot during and after operating.

Caution: Burn hazard!



Wear personal protective equipment. (Gloves, protective goggles, protective clothing and safety shoes)

1. Prepare generator.

- Assure generator against accidental start.
- Open the generator casing.
- with generators that have an external oil drain hose: Release the oil drain hose from the mounting.
- with generators that have an internal oil drain hose: Open the lead-through for the oil drain hose (left turn of the sealing). Pull out the sealing with the oil drain hose.

Place an oil resistant mat under the oil drain hose area and prepare the container.

2. Loosen oil filling cap

Unscrew the oil filling cap. This is necessary, because otherwise a vacuum will form and the oil can not completely drain off.

Sample picture

Fig. 7.7-1: Oil filling cap



3. Open oil drain screw.

Unscrew the oil drain screw by means of the open-ended wrench from the oil drain hose (rotating direction left). Use a second open-ended wrench to lock. Make sure to do this over the container. Use spanner size 17 mm.



Fig. 7.7-2: Oil drain hose



4. Discharge used oil.

Let the entire amount of oil drain out of the engine. This can take several minutes.

5. Remove used oil filter / clean oil screen

Release the oil filter by turning the filter wrench counterclockwise. The filter might be full of oil. Make sure to not spill anything and avoid skin contact.

Sample picture



Fig. 7.7-3: Oil filter

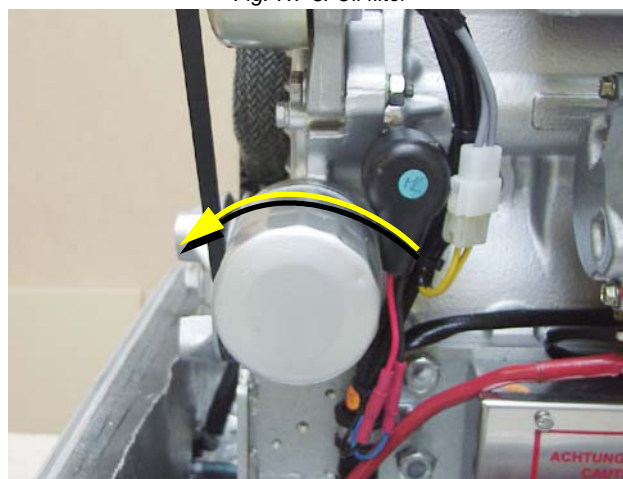

Oil screen with generators with EA300 engines

The oil screen should be cleaned every 500 operating hours: to do so follow the instructions in the engine manual.

Use spanner size 17 mm.



Sample picture

Fig. 7.7-4: Oil screen



6. Preparing a new filter

Clean the engines' filter holder brush a thin oil layer on the sealing of the new filter.

Fig. 7.7-5: Oil screen sealing ring



7. Mounting the new filter

Carefully screw in the new filter by hand. It must not be tightened too much. Screw in the oil drain screw again and tighten it with the wrench. Use a new sealing for the oil drain screw.

8. Fill in oil. (oil fill capacity: see attachment)

Fill the engine oil into the engine via feed hopper. Check oil-level after every 2 litres with the oil dipstick.

9. Check proper filling level. See section 7.6, "Checking oil-level," on page 77.

When the proper filling level is reached, screw in the oil cap again. Run the engine for 10 minutes and then turn it off. Check the oil-level once more after several minutes with the oil dipstick. If it is too low, refill some oil.

10. Clean up

Wipe off all oil splashes from the generator and make sure that the drain screw has no leak.

7.7.1 After the oil change

- Put the oil dipstick back into the check rail.
- Close the oil filling cap.
- Remove potential oil stains and splashes from the generator and surroundings.
- Close the generator casing.
- Remove lock against accidental generator start.
- Duly dispose of used oil and filter.

Used oil is very toxic and must not be disposed with domestic waste. It is prohibited to dispose used oil with waste water! Make sure that used oil is disposed properly (e.g.: where oil is bought or at collection stations).

7.8 Verifying the starter battery and (if necessary) the battery bank

Check the condition of the battery. Proceed here as prescribed by the battery manufacturer.

If from the battery manufacturer not otherwise mentioned.

7.8.1 Battery

7.8.1.1 Check battery and cable connections

- Keep battery clean and dry.
- Remove dirty clamps.
- Clean terminal posts (+ and -) and clamps of the battery, and grease with acid-free and acid-resistant grease.
- When reassembling, ensure that clamps make good contact. Tighten clamp bolts hand-tight.

Fig. 7.8.1.1-1: Battery

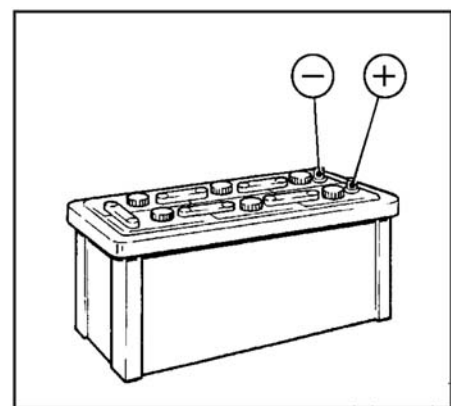

7.8.1.2 Check electrolyte level

- Remove sealing caps 1.
- If testers 2 are present:
- Electrolyte level should reach the base of these.
- Without testers:
 - The electrolyte level should be 10-15 mm above the top of the plates.
- If necessary, top up with distilled water.
- Screw sealing caps back in.

Fig. 7.8.1.2-1: Battery

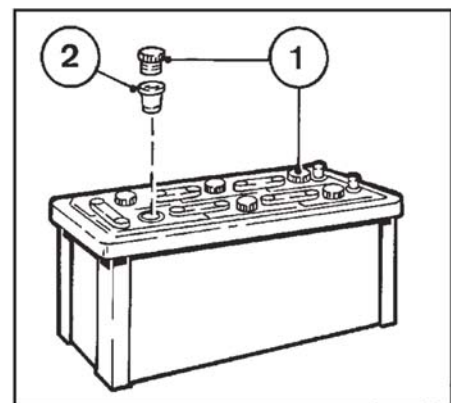

7.8.1.3 Check electrolyte density

- Measure the electrolyte density of individual cells with a commercial hydrometer. The hydrometer reading (see table on following page) indicates the battery's state of charge. During measurement, the temperature of the electrolyte should preferably be 20 °C.

Fig. 7.8.1.3-1: Battery

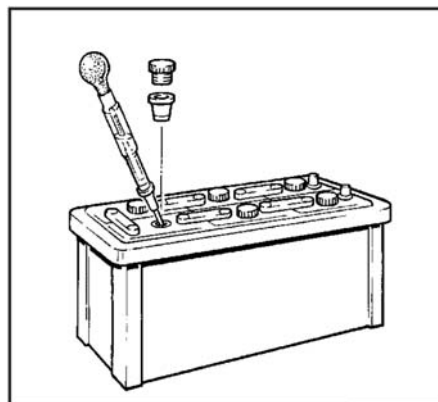

Electrolyte density		
in [kg/ l]		Charge status
Normal	Tropical	
1.28	1.23	well charged
1.20	1.12	semi-charged, re-charge
1.12	1.08	discharged, immediately charge

The gases emitted by the battery are explosive! Keep sparks and naked flames away from the battery!

Attention



Do not allow battery acid to come into contact with skin or clothing!

Wear protective goggles!

Do not rest tools on the battery!

7.9 Ventilating the fuel system

Normally, the fuel system is designed to ventilate air itself i.e. as soon as the electric starter motor starts operation the fuel pump starts working and the fuel system will be de-aerated after some time automatically. It is nevertheless essential to ventilate the system as follows prior to the first operation (as all hoses are empty):

Generators with iControl system do not need a Failure bypass switch. At these generators the fuel pump can be activated by an option of the control panel. See Control panel manual.

Attention:



1. Main power switch „OFF“

2. Press failure bypass switch and keep firmly pressed. The electrical fuel pump must be audible. Switching on and off the solenoid valve at the generator will be audible by pressing the failure bypass switch (if capsule removed).

Note!



Generators with iControl system has no failure bypass switch. The Fuel pump can be activated at the iControl panel.

Please see iControl manual for details.

Fig. 7.9-1: Failure bypass switch

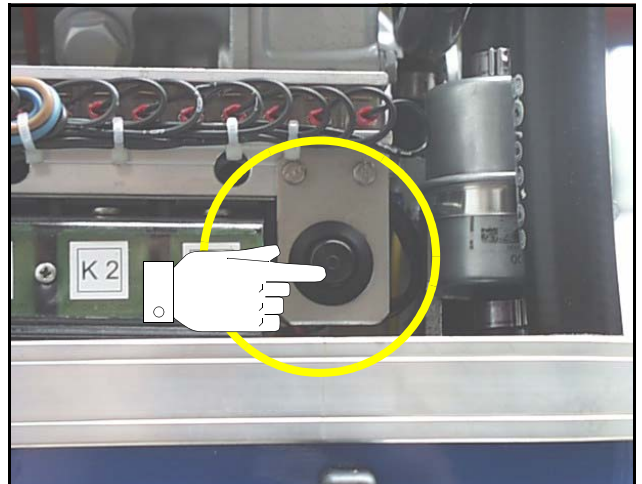

3. Pressing the failure bypass switch for approx 3 - 4 minutes will loosen the ventilation screw located at the fuel solenoid valve. The button must continue to be pressed, whilst opening the screw. A large cloth or Kleenex tissue must be laid beneath the connection to prevent escaping fuel running into the capsule. If the fuel runs out without air bubbles, then the ventilation screw can be closed. Only then may the button be released.

Use spanner size 10 mm.



Fig. 7.9-2: Ventilation screw at the fuel solenoid valve

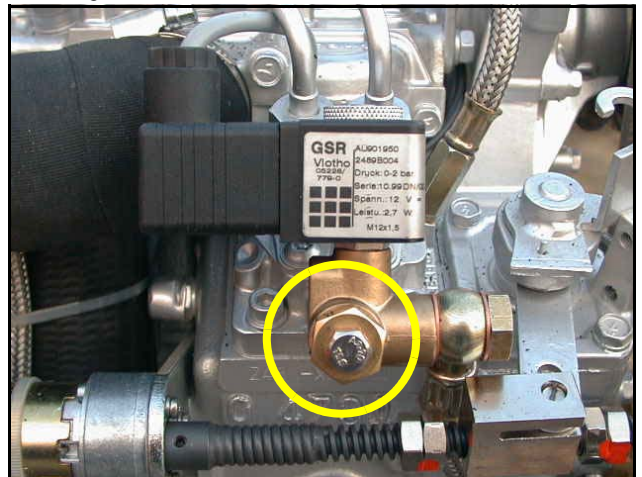

Not all generator models has a fuel solenoid valve. At generators without fuel solenoid valve, a single ventilation screw is installed.

Note!:



4. Pressing the starter button can now start the machine. The machine should start after a short period.
5. If this does not occur, then a connecting nut fitted to the injection line must be loosened and starting procedure repeated. Retighten the washers after successfully starting. The injection line must be raised by several millimetres.

Use spanner size 17 mm.



Fig. 7.9-3: Injection nozzles

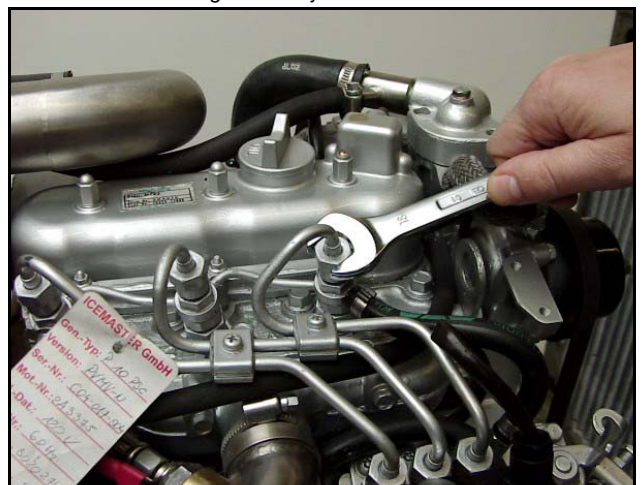

6. Switch main switch „OFF“.

7.9.1 Replacement of the fuel filter

Exchanging the filter, depending upon fuel contamination, should take place after 300 operational hours at the very least. The inlet must be clamped, before exchanging the filter.

Remove the hoses from the used filter and fasten them to the new filter. The arrow on the filter housing indicates the direction of the fuel flow. A clogged filter causes a decreased power output of the generator.

Fig. 7.9.1-1: Fuel Filter



7.9.1.1 Optional fuel filter with sight glass

The filter change depends on the fuels' degree of pollution, but should be executed every 300 operating hours at the latest.

- 01. Fuel filter housing
- 02. Fuel filter element
- 03. Sight glass

Fig. 7.9.1.1-1: Fuel filter

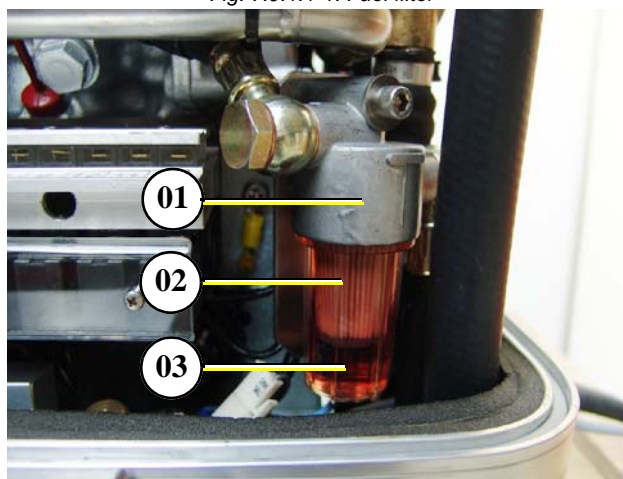

1. Unscrew the housing from its mount (left hand rotation).

Fig. 7.9.1.1-2: Fuel filter



2. Unscrew the filter element from the mount (left hand rotation).

Fig. 7.9.1.1-3: Fuel filter



3. Screw the new filter element into the mount.
4. Lubricate the sight glasses o-ring with a heat resistant grease (Specification: Antiseize) and screw the sight glass back into its mount (right hand rotation).

Fig. 7.9.1.1-4: Fuel filter



7.10 Checking the water separator in the fuel supply

Pre-filter with water separator

The pre-filter with water separator has a cock underneath, by which means the water can be drained.

This water sinks to the bottom, due to its density. It is heavier than the diesel

Fig. 7.10.0-1: Pre-filter with water separator



7.11 Replacing the V-belt at Kubota 02/03/05 series

The described procedure is representative for Fischer Panda generators. The original location of the item must be taken from the generator description of this manual. All replacements and repairs should be done by a trained person.

NOTE:Reprehensive procedure



Due to the relatively high ambient temperature inside the closed sound insulation capsule (approx. 85 °C), the useful life of the V-belt is reduced. It is possible that the plasticisers in the rubber compounds may partially lose their effectiveness even after a short operating time because the air in the sound insulated capsule can be both relatively warm and dry.

The V-belt must therefore be checked at very short time intervals. It may be necessary to replace the V-belt after several weeks because of unfavourable conditions. A replacement interval of 250 operating hours must never be exceeded. The V-belt should be inspected after 50 operating hours. The V-belt must be considered a wearing part.

1. Loosen the fixing screw above the alternator.

Wrench with width across flats of 12 mm.



01. Fixing screw

Fig. 7.11-1: Alternator fixing screw

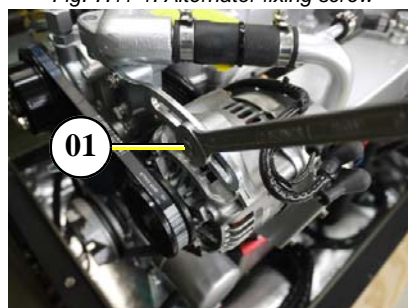

2. Loosen the fixing screw below the alternator.

Wrench with width across flats of 12 mm.



01. Fixing screw

Fig. 7.11-2: Alternator fixing screw

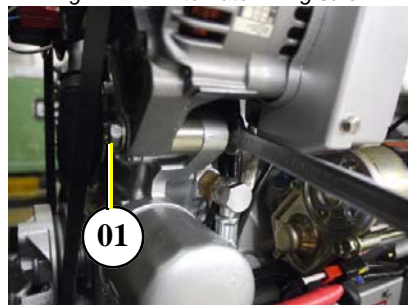

3. Push alternator towards the thermostat housing.

4. Replace the V-belt (Quad Power XPZ 862).

Fig. 7.11-3: Replacing the V-belt



- The V-belt is tensioned by pulling back the alternator. The V-belt should yield approx. 1 cm when pushed in with a thumb.

Re-tighten the screws above and below the alternator.

Fig. 7.11-4: Replacing the V-belt

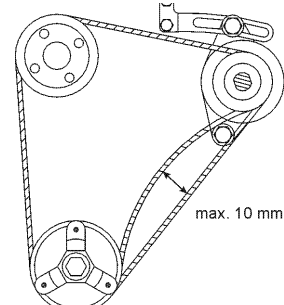

7.11.1 Replace the air filter mat

- Open the air suction housing by loosen the six screws on the housing cover.

Use spanner size 8 mm.



Fig. 7.11-1: Air suction housing

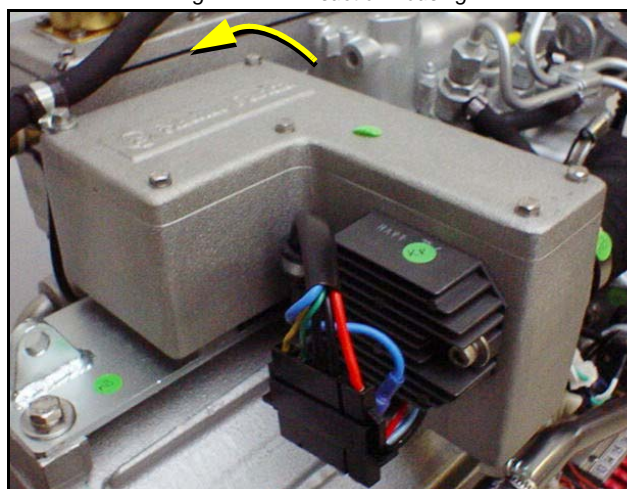

- Change the air filter mat.
- Close the suction air housing.

Fig. 7.11-2: Opened air suction housing



7.11.2 Alternative replacement of the air filter mat with pull out holder

1. Air filter housing with pull out holder.

Fig. 7.11.2-1: Air suction housing with pull out holder

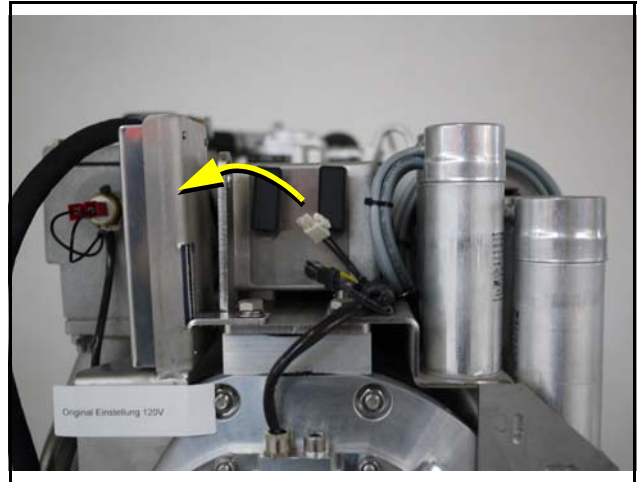

2. Tip the two fasteners 90°.

Fig. 7.11.2-2: Air suction housing with pull out holder



3. Pull the filter mat holder out.

Fig. 7.11.2-3: Air suction housing with pull out holder



4. Replace the air filter mat.
5. Re-assembly in reversed order.

Fig. 7.11.2-4: Air suction housing with pull out holder

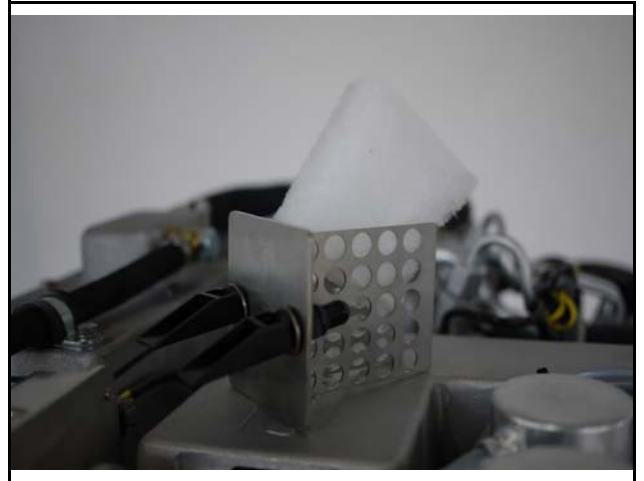

7.11.3 Alternative replacement of the air filter at housing with snap fasteners

1. Open the combustion air housing by loosening the closure on the right side of the housing.

01. Closure

Fig. 7.11.3-1: Air suction housing

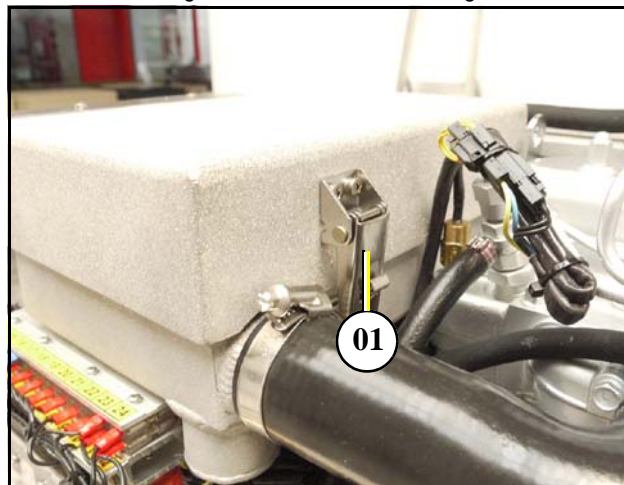

2. Open the combustion air housing by loosening the closure on the left side of the housing.

01. Closure

Fig. 7.11.3-2: Air suction housing

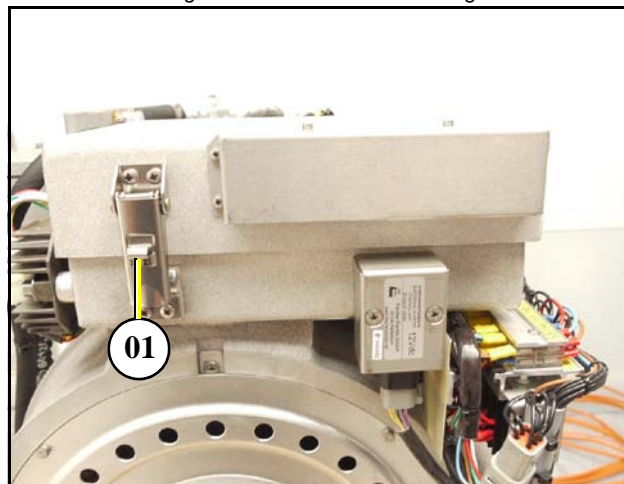

3. Open the air housing by pulling the cover.
4. Lift out the air filter element of the cover of the air filter housing.

01. Air filter

5. Replace cover in reverse procedure.

Fig. 7.11.3-3: Air suction housing

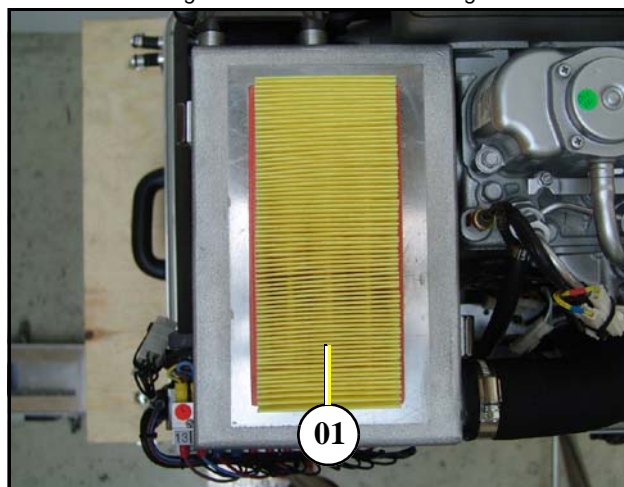

Sample picture

7.11.4 First filling and ventilation of the internal cooling water circuit

The expansion tank is supplied with a pressure relief valve in the cap with 500 mbar. It is possible when operating the generator hot cooling water can leak here if there is an overpressure. When working always wear protective clothing and ensure an adequate installation location.

ATTENTION!: Risk of scalding.



1. Fill up the external cooling water expansion tank with coolant.

ATTENTION: Maximum fill level = „max.“- marking

The cover of the external expansion tank must be opened temporarily (all other closures are now closed!).

Sample picture

Fig. 7.11.4-1: Expansion tank



2. Open the venting screw at the pipe socket of the internal cooling water pump until bubble-free coolant escapes. Close the vent screw.

(not existent at all models)

Check the water level in the expansion tank during the venting. Fill up if necessary.

Never open the vent screw while the generator is running because water may be sucked into the cooling water circuit.

Sample picture

Fig. 7.11.4-2: Venting screw at the pipe socket

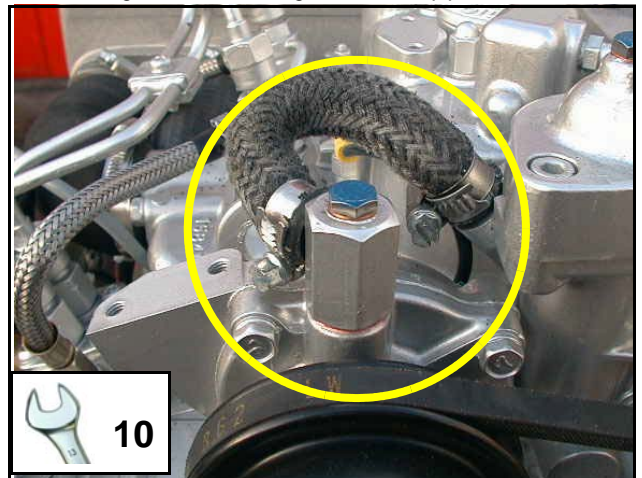

3. Open venting screw at the thermostat housing. Close the vent screw when air free water comes out.

Check the water level in the expansion tank during the venting. Fill up if necessary.

Sample picture

Fig. 7.11.4-3: Venting screw at the thermostat housing

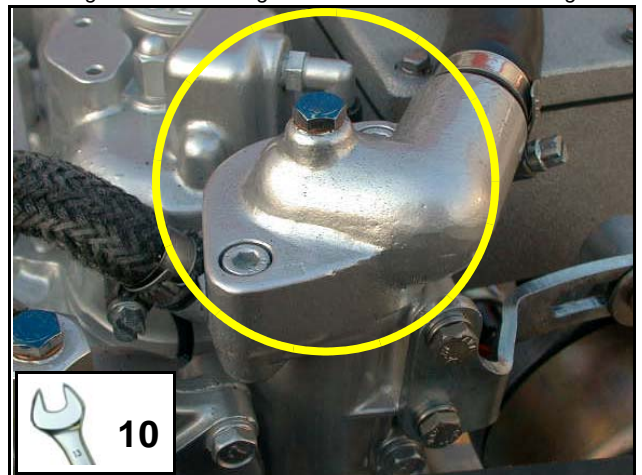

4. Start the generator

After filling the generator must be started. During this first phase of start-up, the generator may not be loaded.

Switch off the generator after approx. 10 seconds of operation!

5. Repeat the steps 1-4 till no more air comes out of the venting screw at the thermostat housing.

Close the venting screws.

Fill up the expansion tank up to max. marking.

Close the expansion tank.

6. Re-ventilating process 10 operating hours after the first start-up (and if necessary).

Also after the first initial operation a small amount of air may reside in the cooling circuit. To ensure an immaculate und actual operation of the cooling system the ventilating process must be repeated casual in the next few days (weeks, if necessary). Small amount of air will still exit out of the ventilating openings, especially if the generator stood still for a long time.

During the ventilating process repeated checks must be made to check the cooling water is indeed circulating. If there are air bubbles in the internal cooling water pump, it is possible that the cooling water is not circulating. The generator will heat up very quickly and switch off, because of overheating.

ATTENTION: Check circulation



7.11.4.1 Anti-freeze in the cooling water circuit

In the interest of safety, the concentration of the coolant should be checked on a regular basis. Be sure that the coolant/antifreeze mixture is good for at least -15 °C (5 °F) which is recommended by the manufacturer. If your genset experiences lower temperatures, for example during storage or transportation, then the entire cooling system should be drained. The coolant also serves as corrosion protection of the engine.

7.11.5 Temperature check for controlling the cooling water circuit

Check with an IR-thermometer if a temperature difference exists between cooling water in-flow and cooling water return flow.

The cooling water in-flow line can be measured directly at the internal cooling water pump.

The cooling water return pipe can be measured either at the outlet of the water-cooled exhaust elbow or at the side where this pipe enters the heat exchanger.

The temperature difference between in-flow and return should be approx 10-18 °C at nominal rating.

Some generators are equipped with an additional cooling water cap.

This only serves for the first filling at the factory.

This cap may not be opened when the generator is installed (hot cooling water may escape). Risk of scalding!

Sample picture

Fig. 7.11.5-1: Cooling water cap

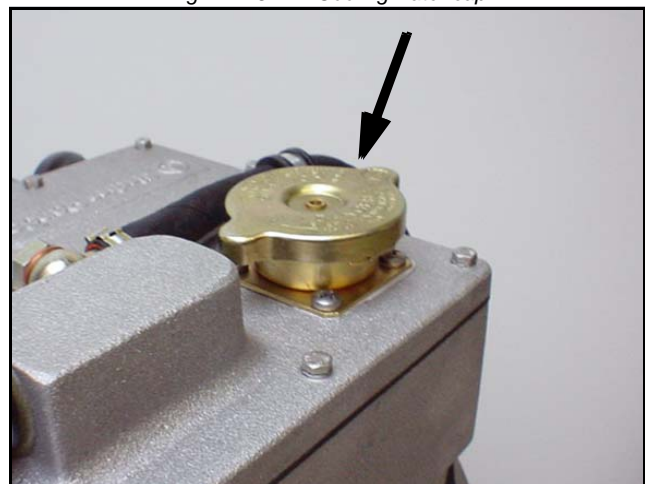

7.11.6 The Raw water circuit

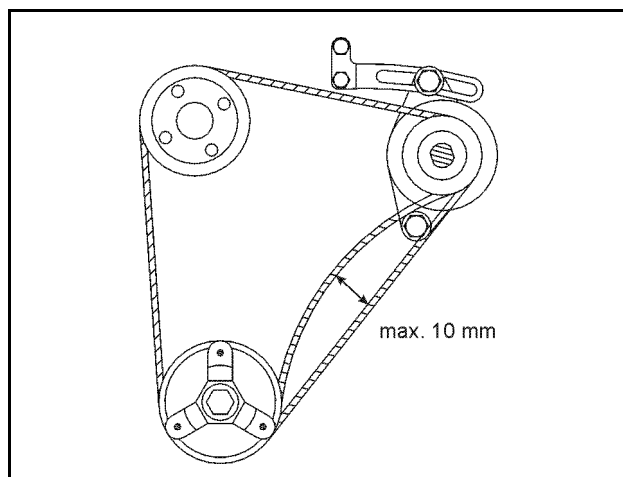

7.12 The raw water circuit

7.12.1 Clean raw water filter

The raw water filter should be released regularly from arrears. In each case the water cock must be closed before. It is mostly sufficient to beat the filter punnet.

If water should seep through the cover of the raw water filter, this may be sealed in no case with adhesive or sealant. Rather must be searched for the cause for the leakage. In the simplest case the sealing ring between caps and filter holders must be exchanged.

Fig. 7.12.1-1: Raw water filter



7.13 Causes with frequent impeller waste

The impeller of the cooling water pump must be regarded as wearing part. The life span of the impeller can be extremely different and exclusively depends on the operating conditions. The cooling water pumps of the PANDA generators are laid out in such a way that the number of revolutions of the pump lies low compared with other gensets. This is for the life span of the pump a positive effect. Unfavourable affects the life span of the impeller, if the cooling water sucking in way is relatively long or the supply is handicapped, so that the cooling water sucking in range develops a negative pressure. This can reduce first of all the power of the cooling water pump extremely that the wings of the impeller are exposed to very strong loads. This can shorten the life span extremely. Further the operation of the impeller pump loaded in waters with a high portion of suspended matters. The use of the impeller

pump is particularly critical in coral water bodies. Cases are well-known, which a impeller pump had so strongly run after 100 hours already that the lip seal on the wave was ground in. In these cases sharp crystal parts of the coral sand assess in the rubber seal and affect like an abrasive the high-grade steel shank of the impeller pump. If the generator were mounted over the water level it is particularly unfavourable for the impeller pump. After the first start some seconds will pass by, until the impeller can suck in cooling water. This short unlubricated operation time damages the impeller. The increased wear can lead after short time to the loss. (see special notes: "Effects on the impeller pump, if the generator is mounted over the waterline")

7.13.1 Replacement of the impeller

Close the raw water stop cock.

Representative picture

Fig. 7.13.1-1: Raw water cock

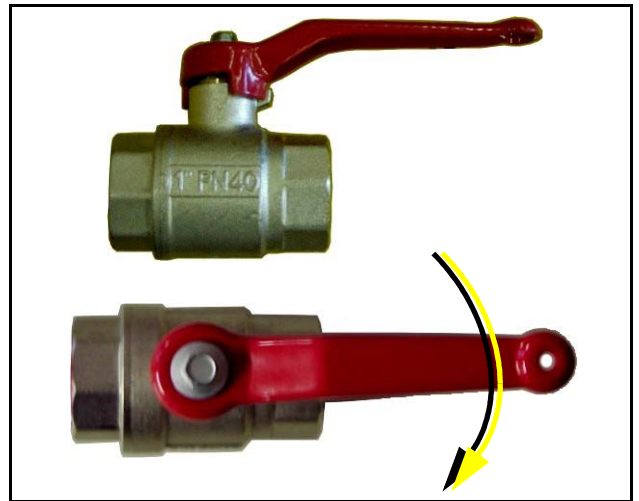

Raw water pump on the front side of the genset.

Representative picture

Fig. 7.13.1-2: Raw water pump

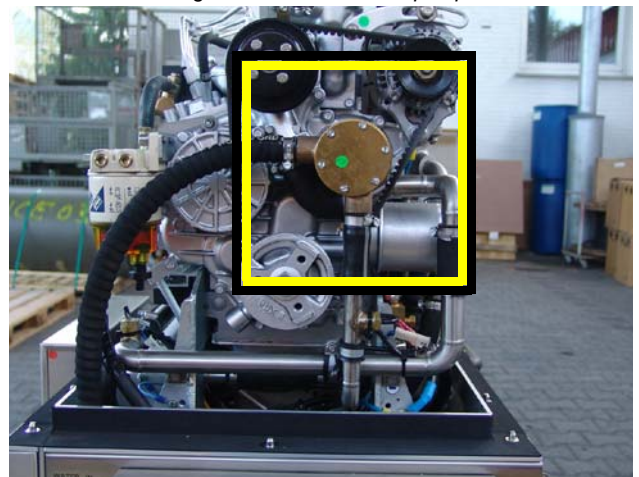

Remove the cover of the raw water pump by loosen the screws from the housing.



Representative picture

Fig. 7.13.1-3: Cover raw water pump

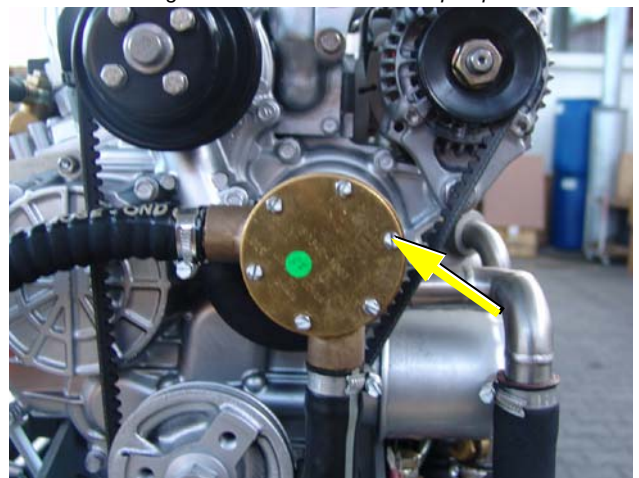

Pull to the impeller with a multigrip pliers of the wave.



Mark the impeller, to make sure that these is used in the correct position at re-installation.

Representative picture

Check to the impeller for damage and replace it if necessary.

Before the reinsertion into the housing the impeller should have been lubricated with glycerin or with a non-mineral oil based lubricant e.g. silicone spray.

The impeller is attached to the pump wave (if the old impeller is used, pay attention to the before attached marking).

Representative picture

Fastening the cover and use a new seal.



Representative picture

Fig. 7.13.1-4: Impeller pump

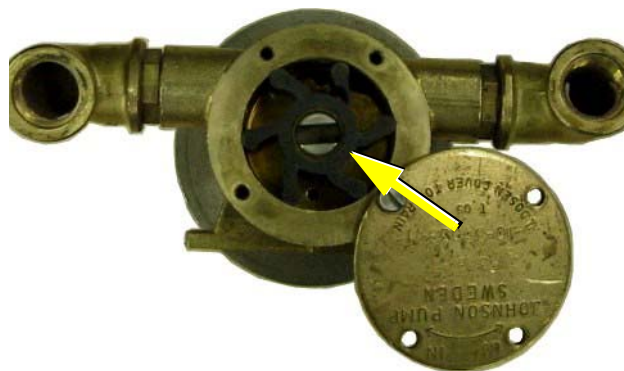
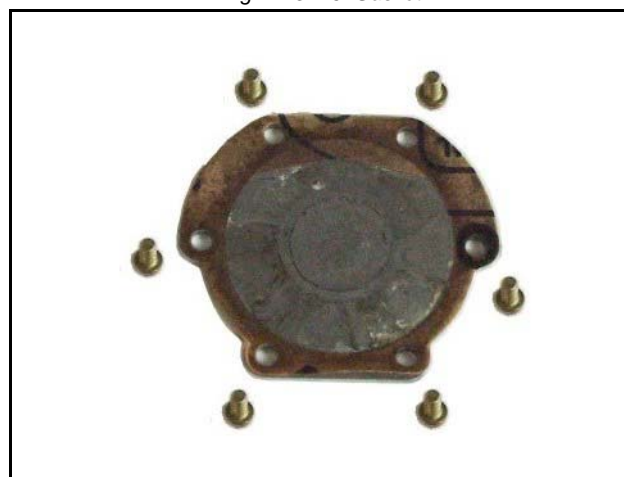

Fig. 7.13.1-5: Impeller



Fig. 7.13.1-6: Gasket



8. Generator Failure

8.1 Personal requirements

The work described here, unless otherwise indicated, are performed by the operator.

More repair work may be performed only by specially trained personnel or by authorized repair shops (Fischer Panda service points). This is especially for working on the valve timing, fuel injection system and the engine repair.

8.2 Safety instructions for this chapter

Also consider the general safety instructions at the first pages of this manual.

Notice!:



Danger for life! - The generator can be equipped with a automatic start device. This means the generator can be started by an external signal. To avoid an unexpected starting of the generator, the starter battery must be disconnected before start working at the generator.

Warning!: Automatic start



Working at a running generator can result in severe personal injury. Therefore before starting work at the generator:

Warning!: Risk of injury

Make sure that the generator is stopped and the starter battery is disconnected to guarantee that the generator cannot be inadvertently started.



Do not run the generator with removed sound isolation cover.

Improper installation/maintenance can result in severe personal injuries or material damage.

Warning!: Risk of injury

- Always undertake installation/maintenance work when the generator is switched off.

- Ensure there is sufficient installation clearance before start working.

- Ensure tidiness and cleanliness at the workplace. Loose components and tools lying around or on top of each other are sources of accidents.

- Only perform installation work using commercially available tools and special tools. incorrect or damaged tools can result injuries.



Oil and fuel vapours can ignite on contact with ignition sources. Therefore:

- No open flames during work on the generator.
- Do not smoke.
- Remove oil and fuel residues from the generator and floor.

Contact with engine oil, antifreeze and fuel can result in damage to health. Therefore:

- Avoid skin contact with engine oil, fuel and antifreeze.
- Remove oil and fuel splashes and antifreeze from the skin immediately.
- Do not inhale oil and fuel vapours.

Danger for Life. Improper handling, operation, installation and maintenance can result in severe personal injury and/or material damage.

Electrical voltages above 48 volts (battery chargers greater than 36 volts) are always dangerous to life). The rules of the respective regional authority must be adhered to. Only an electrician may carry out installation of the electrical connections for safety reasons.

Generator, oil and antifreeze can be hot during/after operation. Risk of severe burns.

During Installation/maintenance personal protective equipment is required to minimize the health hazards.

- Protective clothing
- safety boots
- protective gloves
- Ear defender
- safety glasses

Disconnect all load during the work at the generator to avoid damages at the load.

Warning!: Danger of fire



Danger!: Danger of poisoning



ATTENTION!: Danger to Life - High voltage



Warning!: Hot surface/material



Instruction!: Personal protective equipment necessary.



Attention!: Disconnect all load



8.3 Tools and measuring instruments

In order to be able to manage disturbances while driving, following tools and measuring instruments should belong to the equipment on board:

- Multimeter for voltage (AC), frequency and resistance
- Measuring instrument for inductance
- Measuring instrument for capacity
- Current absorbing clamps
- Thermometer (ideal is a infrared thermometer)
- Pressure device (pincer) for coolant circuit

8.4 Overloading the generator

Please ensure that the genset is not overloaded. Overloading occurs when the electrical load (demand) induces a load torque in the generator which is higher than that which the diesel drive motor can provide. Overloading causes the engine to run rough, burn oil, creates excessive exhaust (environmentally unfriendly) and even to stall. Extra caution should be practised with multi-power units (single and 3-phase current generation) to avoid overloading the diesel drive engine.

The generator should only be loaded at the peak rated power for short periods only! A high peak current is required to start many electrical devices, especially electric motors and compressors (from a still stand state).

In order to prolong the genset's life expectancy, the nominal electrical demand on the system should not be more than 70% of the rated genset peak load.

Keep PEAK LOADING demand in mind when switching on electrical devices (esp. fridge compressors, electric motors, battery chargers, kettles, etc.) which are fed by the generator. Careful „powering up“ (gradual loading) of the electrical demand on the generator will help prolong the life of your genset! The genset can be run for several hours at partial load (i.e. 2/3 of rated power), however it is not advised that it is run for more than 2-3 hours at full load. The Panda is designed so as not to overheat even under extreme conditions. Note: The exhaust gas will become sooty during peak-load operation.

Effects of Short Circuiting and Overloading on the Generator

The generator **cannot** be damaged by short circuiting or overloading. Short circuiting and overloading suppress the magnetic excitation of the generator, thus, no current is generated and the voltage will collapse. This condition is immediately offset once the short-circuit has been eliminated and/or the electrical overload removed.

8.4.1 Low generator-output voltage

Before working on the System read the section “Safety first!” on Page 12.

ATTENTION!



If the produced alternating voltage is too low, switch the load off, in order to relieve the generator. Mostly the problem already solved. If the output voltage is still too low, even if all load is switched off, the generator runs without load, you can assume one or more condensers are defective.

8.5 Starting problems

8.6 Starting Problems

8.6.1 Fuel Solenoid Valve (optional)

All engines are equipped with an electric inlet fuel solenoid valve (12V) which switches off the motor.

The fuel solenoid valve is located in front of the injection pump. It opens automatically, if the „START“-button is pressed on the remote control panel. The solenoid valve is CLOSED when the generator main power is switched „OFF“. For this reason, it requires a few seconds before the motor comes to a full halt

If the generator fails to start, runs rough, does not reach the proper RPM, or does not stop properly, the first item to suspect in most cases is the fuel solenoid valve and should be inspected first.

A check of the fuel solenoid valve by removing the plug from the fuel solenoid valve for a short period whilst in operation (first remove the small retention screw) and replace it immediately. The motor should „react immediately“ by revving high. If the motor does not react sharply to the reconnection of the solenoid wire, it is a sign that the solenoid valve could be faulty.

- 01. Fuel solenoid valve
- 02. Fuel injector line
- 03. Ventilation screw

Fig. 8.6.1-1: Fuel solenoid

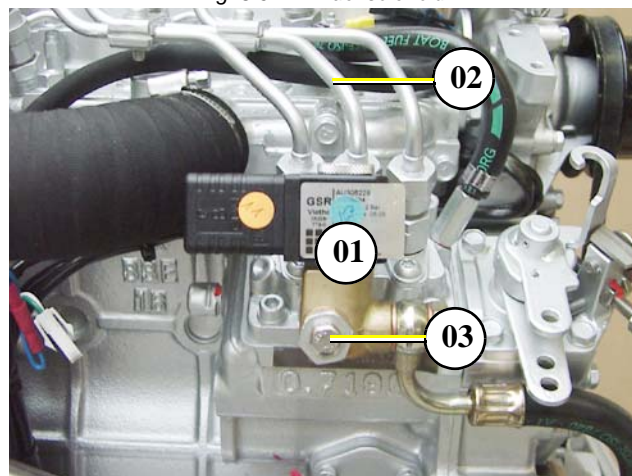

8.6.2 Failure Bypass Switch

The start-failure bypass switch enables an immediate restart facility of the generator, should it cut out, even if this was caused by over-heating. There is normally a requirement to wait until the motor has cooled down to the correct temperature. This can last for several hours in certain circumstances, since the generator is enclosed in a sound-

insulated casing, which prevents heat loss.

Failure bypass switch

Fig. 8.6.2-1: Failure bypass switch

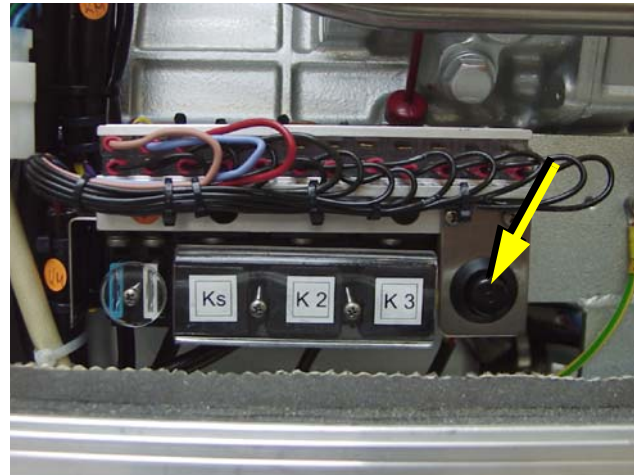

This period can be reduced by pushing the button on the front of the generator. The generator can be started by means of the remote control as long as the button is depressed. The switch/button bypasses any faults allowing the generator to run.

Before depressing the button, a manual check of the oil dip stick must be carried out to determine whether the generator has sufficient oil, as it is possible that the oil pressure switch causes the generator to cut out. If it has been ascertained that the reason for the motor cutting out is overheating and not lack of oil, the generator can be run for several minutes without load, so that the motor is cooled by the circulating coolant.

BEWARE:

If the temperature is the reason for the generator cutting out when it is running under load, then an immediate check must be made to determine the cause. It could be a fault with the cooling system, one of the fans, the air-intake or a fault with the external cooling system.

Continual use of the starter-failure bypass switch should be avoided, while the generator cuts out during operation.

The generator must always run without load for several minutes before being switched off, so that a temperature compensation occurs. Heat accumulation can cause the generator to overheat, even after it has been switched off.

Should the overheating alarm be set off, caused by heat accumulation, after the generator has been switched off, then this can also be bypassed using the switch.

8.6.3 Stop solenoid

There are two different variations:

A. Energized to stop

By pressing the „OFF“-button on the remote control panel the stop solenoid is supplied with voltage and operate, through this the injection nozzles resets to zero position and the generator stops.

B. Energized to run

This version is equipped with two solenoids an actuating and a stop solenoid. After being fed with current, the actuating solenoid attracts the adjusting lever of the fuel injection pump, through which the fuel can flow. The actuating solenoid is switched off once the final position has been reached, which is maintained by the stop solenoid for as long as the generator is running

When starting the „START“-button may not be pressed longer than 5 sec., because the stop solenoid pulls too much current over the starter. Otherwise the stop solenoid must be disconnected.

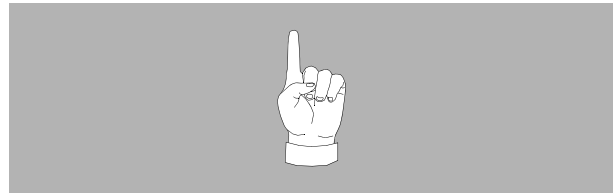
.Notice!:**Stop solenoid (optional)***Fig. 8.6.3-1: Stop solenoid*

8.7 Troubleshooting table

For troubleshooting see section 9.1, “Troubleshooting,” on page 105

9. Tables

9.1 Troubleshooting

GENERATOR OUTPUT VOLTAGE TOO LOW	
If the generator delivers less than 24V current („undervoltage“), there can be various reasons for this:	
Cause	Solution
PGMi is overloaded.	Reduce the electrical load. (Switch off load)
Motor is not reaching the rated rpm.	Refer to „motor faults“ section.

MOTOR DOES NOT TURN OVER WHEN STARTING	
Cause	Solution
Battery main switch is switched off.	Check the position of the battery main switch, if necessary switch on.
Battery voltage not sufficient.	Check that connection is firm and whether corrosion has occurred.
Starting current fault.	The voltage of full batteries fall to a maximum of 11V. The wiring is severed if the voltage does not drop. The battery is discharged if the voltage drops further.

MOTOR TURNS OVER BUT DOES NOT START	
Cause	Solution
Stop solenoid valve not opening.	Check wire connections and circuitry to solenoid valve. (ref. DC wiring diagram: Relay K2, Fuse)
Fuel pump does not operate.	Check fuel-filter and pump: clean if necessary.
Lack of fuel.	Check fuel supply.
Glow-plugs not working correctly.	Check glow plugs and heating time.
Too much air in fuel lines.	Test fuel system for leakage. Bleed air from fuel system (refer to section „Air-bleeding of the Fuel System“).
Fuel filter blocked.	Replace fuel filter.
Low compression pressure.	See Kubota motor-manual.

MOTOR DOES NOT TURN OVER AT THE NORMAL SPEED DURING THE STARTING PROCESS	
Cause	Solution
Starter battery voltage insufficient.	Check battery.
Damaged bearing(s) piston (seized).	Repairs need to be carried out by Kubota-Service. (refer to Kubota motor-manual)
Cooling water in combustion chamber.	<ol style="list-style-type: none"> 1. Turn generator „OFF“ at control panel. 2. Remove the glow plug (see Kubota-manual). 3. Rotate the motor by hand carefully. 4. Check if there is water in the oil and change both oil and filter if necessary. 5. Determine cause for excess water in the combustion chamber. The excess water can be caused by a defective air vent in the cooling water system, which should be checked and cleaned, or replaced if faulty.

MOTOR RUNS IRREGULARLY	
Cause	Solution
Faulty centrifugal injector governor.	Have the centrifugal governor inspected by a Kubota-Service technician.
Too much air in fuel lines.	Bleed air from fuel system.

DROP IN THE SPEED OF THE MOTOR	
Cause	Solution
Too much oil.	Drain oil.
Lack of fuel.	Check fuel supply system: - fuel filter, renew if necessary - check fuel pump - check fuel lines (bleed if necessary)
Lack of intake air.	Check air intake paths. Check and clean air filter (and intake muffler if installed).
Generator overloaded by too many load.	Reduce the electrical load (switch off load).
Defective generator (windings, bearings, or other).	Generator must be sent to manufacturer for repair of damaged bearings or winding.
Damaged engine.	Repair of bearing damage, etc., by Kubota-Service.

MOTOR SWITCHES ITSELF OFF	
Cause	Solution
Fuel solenoid valve or throttle shut solenoid is not switching off.	Check wire connections to solenoid. Check valve functions as in the „Inlet Fuel Solenoid Valve“ or in the throttle shut off solenoid sections. Replace if necessary.

MOTOR STOPS BY ITSELF	
Cause	Solution
Lack of fuel.	Check fuel supply system.
Excess heat in cooling system (thermo switch tripped)- lack of cooling water. Is indicated on the remote control panel.	Check cooling water system flow: water pump, inlet water filter, extra heat exchanger coolant flow.
Lack of oil (oil pressure sensor tripped).	Check oil-level and if necessary top up. Check motor's oil-pressure and have repaired by Kubota-Service if necessary.

SOOTY, BLACK EXHAUST	
Cause	Solution
Generator is overloaded.	Check electrical load and switch off unnecessary load.
Insufficient intake air.	Check intake air filter; clean if necessary.
Fuel injector nozzles faulty.	Replace injector nozzles.
Valve clearance incorrect.	Readjust valve clearance to correct value (refer to Kubota-manual).
Poor fuel quality.	Use better quality diesel (recommended: 2-D Diesel).
Poor combustion.	Incorrect AFR (air/fuel ratio) due to motor timing adjustment. Have motor serviced by Kubota.
Low compression pressure.	See Kubota motor manual.

GENERATOR MUST BE SHUT OFF IMMEDIATELY IF:	
Cause	Solution
- motor rpm suddenly rises or drops - unusual noise comes from genset - exhaust colour suddenly becomes dark - motor overheats - oil pressure drops, oil light suddenly flashes	Refer to respective section of manual and if necessary, have repaired by Kubota-Service, or Panda representative.

9.2 Technical data

9.2.1 Technical Data Engine

9.3 Technical data

Fig. 9.3-1: Technical data igenerators

	Panda 4800i	Panda 5000i	Panda 8000i	Panda 10000i	Panda 15000i
Type	Faryman 18W430	EA300	Z482	Z602	D902
Governor	iControl2	iControl2	iControl2	iControl2	iControl2
Automatic start booster	no	no	no	no	no
Cylinder	1	1	2	2	3
Bore	82 mm	75 mm	67 mm	72 mm	72 mm
Stroke	55 mm	70 mm	68 mm	73,6 mm	73,6 mm
Stroke volume	290 cm ³	309 cm ³	479 cm ³	599 cm ³	898 cm ³
Max. power (DIN 6271-NB) at 3000 rpm	5,7 kW	5,1 kW	9,32 kW	11,6 kW	17,5 kW
Rated speed	3600 rpm	3000 rpm	3000 rpm	3000 rpm	3000 rpm
Idle running speed	3690 rpm	2900 rpm	2900 rpm	3100 rpm	2900 rpm
Valve clearance (engine cold)	0,20 mm	0,16 - 0,20 mm	0,2 mm	0,2 mm	0,2 mm
Cylinder head nut torque	30-33 Nm	58,8 - 63,7 Nm	42 Nm	42 Nm	42 mm
Compression ratio	20:1	--	23:1	24:1	24:1
Lubrication oil capacity	1,25 l	1,3 l	2,8 l	2,8 l	3,7 l
Fuel consumption ³	approx. 0,42 - 1,12 l	approx. 0,42 - 1,12 l	approx. 0,7-1,8 l	approx. 1,0-2,66 l	approx. 1,3-3,6 l
Oil consumption	--	max. 1 % of fuel consumption			
Oil specification	API CF	API CF	API CF	API CF	API CF
Cooling water requirement for seawater circuit (Marine generators only)	--	--	16-28 l/min	16-28 l/min	16-28 l/min
Permissible max. permanent tilt of engine	--	a) 25° crosswise to the longitudinal axis b) 20° in longitudinal direction			
Recommend starter battery size	12 V 28 Ah equivalent	12 V 28 Ah equivalent	12 V 28 Ah equivalent	12 V 36 Ah equivalent	12 V 52 Ah equivalent
Recommend cable cross size starter battery cable <i>Length 4 meter max.</i>	25 mm ²	25 mm ²	25 mm ²	25 mm ²	25 mm ²
Max. exhaust back pressure	--	--	9,3 kPa 93 Millibar ²	9,3 kPa 93 Millibar	9,3 kPa 93 Millibar

³ 0,35 l/kW electrical power, the randomized values between 30 % and 80 % of the rated speed

Fig. 9.3-2: Technical data igenerators

	Panda 25i	Panda 45i			
Type	Kubota V1505	Kubota V2403			
Governor	iControl2	iControl2			
Automatic start booster	no	no			
Cylinder	4	4			
Bore	78 mm	87 mm			
Stroke	78,4 mm	102,4 mm			
Stroke volume	1498 cm ³	2434 cm ³			
Max. power (DIN 6271-NB) at 3000 rpm	23,3 kW	31,1 kW			

	Panda 25i	Panda 45i			
Rated speed	1500 rpm	2700 rpm			
Idle running speed	1800 rpm	1600 rpm			
Valve clearance (engine cold)	0,2 mm	0,18 - 0,22 mm			
Cylinder head nut torque	68 Nm	93,1 - 98 Nm			
Compression ratio	22:1				
Lubrication oil capacity	6,0 l	9,5 l			
Fuel consumption ³	approx. 1,20-3,36 l	approx. 1,95 - 5,2 l			
Oil consumption	max. 1 % of fuel consumption				
Oil specification	API CF	API CF			
Cooling water requirement for seawater circuit (Marine generators only)	28-40 l/min	55-80 l/min			
Permissible max. permanent tilt of engine	a) 25° crosswise to the longitudinal axis b) 20° in longitudinal direction				
Recommend starter battery size	12 V 70 Ah equivalent	12 V 136 Ah equivalent			
Recommend cable cross size starter battery cable <i>Length 4 meter max.</i>	25 mm ²	70 mm ²			
Max. exhaust back pressure	10,7 kPa 107 Millibar	10,7 kPa 107 Millibar			

³ 0,35 l/kW electrical power, the randomized values between 30 % and 80 % of the rated speed

9.4 Diameter of conduits

Fig. 9.4-1: Diameter of conduits

Generator type	Ø Cooling water conduit		Ø Exhaust conduit [mm]	Ø Fuel conduit	
	Freshwater [mm]	Seawater [mm]		Supply [mm]	Return [mm]
Panda PMS 3,8 ND	12	12	30	8	8
Panda PMS 4,5 ND	12	12	30	8	8
Panda PMS 4500 SCB	12	12	30	8	8
Panda PMS 5000 SCE	12	12	30	8	8
Panda PMS 4500 FCB	12	12	30	8	8
Panda PMS 5000 LPE	16	16	30	8	8
Panda PMS 6000 ND	20	20	40	8	8
Panda PMS 8000 NE (8 mini Digital)	20	20	40	8	8
Panda PMS 9000 ND	20	20	40	8	8
Panda PMS 12000 NE (12 mini Digital)	20	20	40	8	8
15 mini Digital	20	20	40	8	8
Panda PMS 14000 NE	20	20	40	8	8
Panda PMS 18 NE (16 Digital)	25	20	50	8	8
Panda PMS 24 NE (22/25 Digital)	25	20	50	8	8
Panda PMS 30 NE	25	20	50	8	8
Panda PMS 33 KU	30	25	50	8	8
Panda PMS 42 KU	30	30	50	8	8
Panda PMS 32 YA	30	30	50	8	8
Panda PMS 50 YA	30	30	60	8	8
Panda PMS 60 YA	-	-	60	8	8

Generator type	Ø Cooling water conduit		Ø Exhaust conduit [mm]	Ø Fuel conduit	
	Freshwater [mm]	Seawater [mm]		Supply [mm]	Return [mm]
Panda PMS 50 MB	40	30	60	8	8
Panda PMS 60 MB	40	40	60	8	8
Panda PMS 75 MB	40	30	60	8	8
Panda PMS-HD 7,5-4 KU	25	20	40	8	8
Panda PMS-HD 09-4 KU	25	20	50	8	8
Panda PMS-HD 12-4 KU	25	20	50	8	8
Panda PMS-HD 17-4 KU	25	25	60	8	8
Panda PMS-HD 22-4 KU	30	30	60	8	8
Panda PMS-HD 30-4 KU	30	30	60	8	8
Panda PMS-HD 40-4 KU	30	30	60	8	8
Panda PMS-HD 60-4 DZ	-	-	-	-	-
Panda PMS-HD 70-4 DZ	-	-	-	-	-
Panda PMS-HD 85-4 DZ	-	-	-	-	-
Panda PMS-HD 110-4 DZ	-	-	-	-	-
Panda PMS-HD 130-4 DZ	-	-	-	-	-

9.5 Cable cross section

Fig. 9.5.0-1: Cable cross section

length	1 - 3 m	4 - 6 m	7 - 10 m	11 - 15 m	16 - 20 m
16 mm ²	70 A	63 A	55 A	48 A	42 A
25mm ²	112 A	100 A	88 A	75 A	63 A
35mm ²	145 A	130	110	100 A	90 A
50mm ²	225 A	200 A	175 A	150 A	125 A
70mm ²	275 A	250 A	225 A	195 A	170 A
95mm ²	340 A	300 A	280 A	260 A	220 A

9.6 Engine oil

9.6.1 Engine oil classification

9.6.1.1 Operating range:

The operating range of an engine oil is determined by SAE class. „SAE“ is for the union of American auto engineers (Society of Automotives Engineers).

The SAE class of an engine oil only informs over the viscosity of the oil (larger number = more viscous, smaller number = more highly liquidly) e.g. to 0W, 10W, 15W, 20, 30, 40. The first number shows the liquid of the oil with cold weather, the second number refers to the fluidity with heat. Complete yearly oils have usually SAE classes of SAE 10W-40, SAE 15W-40 etc.

9.6.1.2 Quality of oil:

The quality of an engine oil is specified by the API standard („American Petroleum Institutes“).

The API designation is to be found on each engine oil bundle. The first letter is always a C.

API C for diesel engines

The second letter is for the quality of the oil. The more highly the letter in the alphabet, the better the quality.

API C for diesel engine

Examples for diesel engine oil:

API CC Engine oil for small demands

API CD Engine oil for suction- and turbo diesel engine

API CF Replace the specification API CD since 1994

API CG Engine oil for highest demands, turbo-tested

See technical data for the specified engine oil

Notice!:



Fig. 9.6.1.2-1: Engine oil type.

Engine oil type	
over 25 °C	SAE30 or SAE10W-30; SAE10W-40
0 °C to 25 °C	SAE20 or SAE10W-30; SAE10W-40
below 0 °C	SAE10W or SAE10W-30; SAE10W-40

Fig. 9.6.1-2: Temp. range of the SAE classes

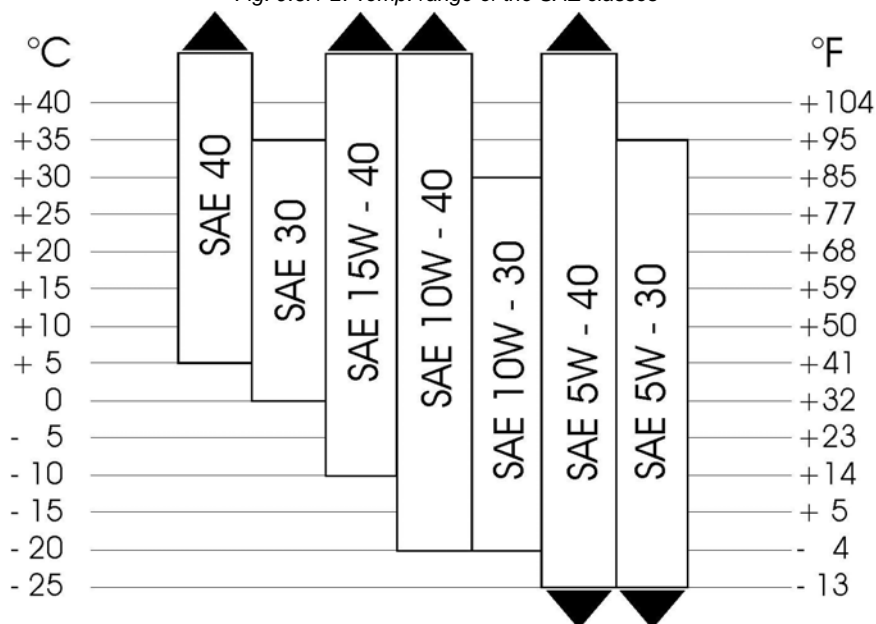

9.7 Coolant specifications

Use a mixture of water and antifreeze. The antifreeze needs to be suitable for aluminium. The antifreeze concentration must be regularly checked in the interests of safety.

Fischer Panda recommend to use the product: GLYSANTIN PROTECT PLUS/G 48

Engine coolant automotive industry Product description	
Product name	GLYSANTIN ® PROTECT PLUS / G48
Chemical nature	Monoethylenglycol with inhibitors
Physical form	Liquid

Chemical and physical properties		
Reserve alkalinity of 10ml	ASTM D 1121	13 – 15 ml HCl 01 mol/l
Density, 20 °C	DIN 51 757 procedure 4	1,121 – 1,123 g/cm ³
Water content	DIN 51 777 part 1	max. 3,5 %
pH-value undiluted		7,1 – 7,3

9.7.1 Coolant mixture ratio

Water/antifreeze	Temperature
70:30	-20 °C
65:35	-25 °C
60:40	-30 °C
55:45	-35 °C
50:50	-40 °C

9.8 Fuel

Use a clean Diesel fuel oil according to DIN590:1999 or better. For Generators with common rail or particle filter use DIN590:2009 or better.

Do not use alternative fuel, because its quality is unknown or it may be inferior in quality. Kerosene, which is very low in cetane rating, adversely effects the engine.

9.9

10. Inverter Panda PMGi

	Document	Hardware	Software
Actual:	R01		
Replace:			

PMGi - representative picture PMGi 25



10.1 Safety instruction

The PMGi may not be taken into use with the cover removed.

All servicing-, maintenance or repair work may only be carried out, when the generator motor is not running.

Electrical voltages above 60 volts are always dangerous to life. The rules of the respective regional authority must be adhered to. Only an electrician may carry out installation of the electrical connections for safety reasons.

Electrical power: DANGER TO LIVE!



Before start working at the Panda i-series Generator/ PMGi (service, repair ect), disconnect the starter battery (First minus cable, then positive cable). This avoid unexpected start of the generator.

10.2 Type plate

1. Location of the type plate

Fig. 10.2-1: Location Type plate

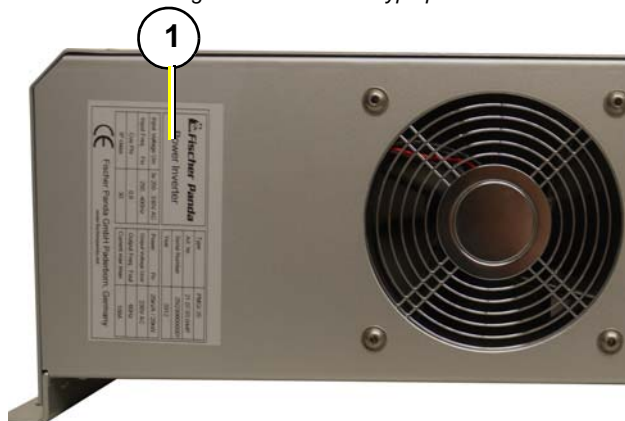



Fig. 10.2-2: Type plate

 Fischer Panda Power Inverter		Type	PMGi 25	
		Art. Nr.	21.07.03.044P	
Input Voltage U_{in}		3x 250...330V AC	Serial Number	25i2306000001
Input Freq. f_{in}		250...400Hz	Year	2012
Cos Phi		0,8	Power P_n	25kVA / 20kW
IP class		30	Output Voltage U_{out}	230V AC
 Fischer Panda GmbH Paderborn, Germany www.fischerpanda.net		Output Freq. f_{out}	60Hz	
		Current max I_{max}	108A	

10.3 Front side/connection side PMGi 230 V - representative picture

To connect the PMGi use the prepared cable and connect to socket 7 (PMGi in)

Fig. 10.3-1: Connection side

Connect your termination box with the socket 1.

Do not cover the air out grille (4)

1. Socket for Load (PMGi out)
2. PE/N bridge
3. FP- Bus socket connection to generator
4. Air out grille
5. Cooling water out (hot side) (Water cooled version only)
6. Cooling water in (cold side) (Water cooled version only)
7. Socket for generator connection (PMGi in)

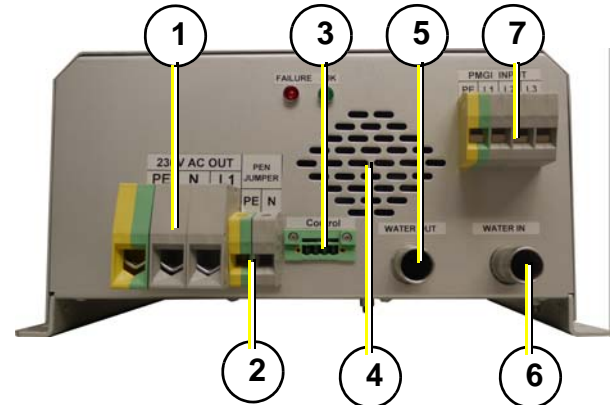

10.4 Alternative front side/connection side PMGi 400 V - representative picture

To connect the PMGi use the prepared cable and connect to socket (PMGi in)

Fig. 10.4-1: Connection side

Connect your termination box with the socket 1. Do not cover the air out grille (4)

1. Socket for Load (PMGi out)
2. PE/N bridge
3. Air out grille
4. FP- Bus socket connection to generator
5. Socket for generator connection (PMGi in)
6. Cooling water in (cold side) (Water cooled version only)
7. Cooling water out (hot side) (Water cooled version only)

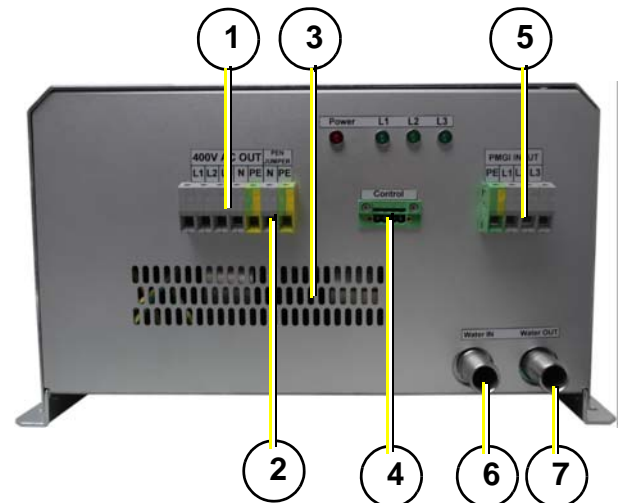

10.5 Alternative front side/connection side PMGi 120 V/240 V - representative picture

To connect the PMGi use the prepared cable and connect to socket 4(PMGi in)

Connect your termination box with the socket 1. Do not cover the air out grille (3)

1. Socket for Load (PMGi out)
2. PE/N bridge
3. Air out grille
4. Socket for generator connection (PMGi in)
5. FP- Bus socket connection to generator
6. Cooling water in (cold side) (Water cooled version only)
7. Cooling water out (hot side) (Water cooled version only)

Fig. 10.5-1: Connection side

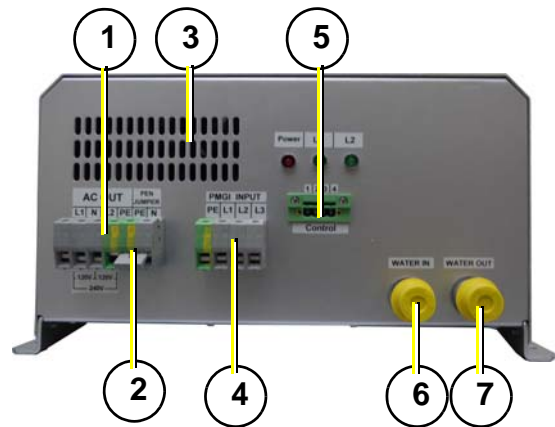

10.5.1 Socket pins of the PMGi

Connecting one Phase with the earth pin will destroy the PMGi **Attention!**



10.5.1.1 PMGi AC out

Single phase - PMGi AC out

Connect your AC terminal box here

representative picture

Fig. 10.5-1: PMGi AC out

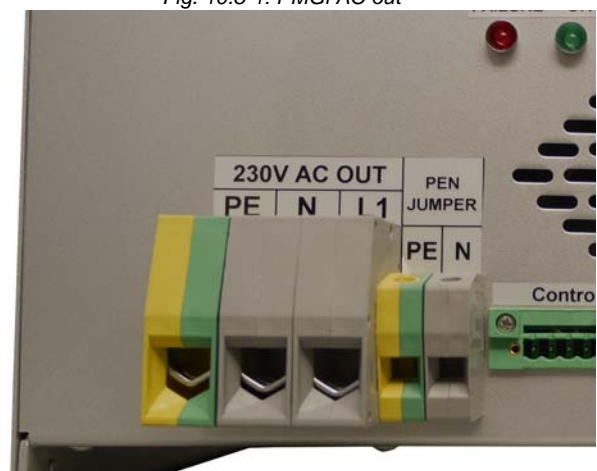

Three phase - PMGi AC out

Connect your AC terminal box here
representative picture

Fig. 10.5-2: PMGi AC out



single phase - PMGi AC out with internal PE/N bridge.

At PMGi where the PE/N jumper is missing next to the PGMGI out, a internal PE/N bridge is installed (f.e. PMGi 5000)

Connect your AC terminal box here
representative picture

Fig. 10.5-3: PMGi AC out

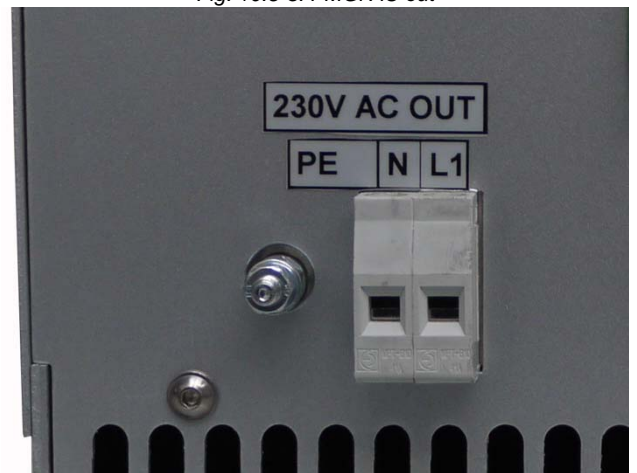

10.5.1.2 PMGi input

PMGi input

Connect the generator power out cable here.
representative picture

Fig. 10.5.1.2-1: PMGi input

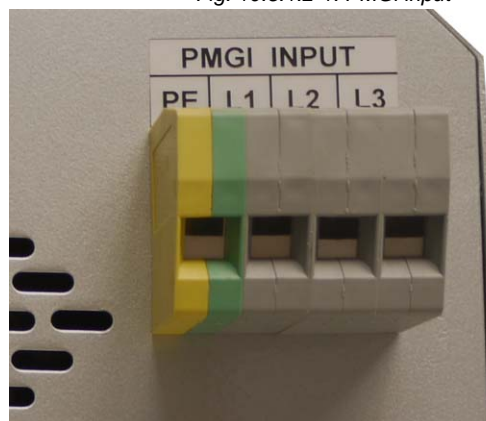

PMGi input alternative Version

Connect the generator power out cable here.

representative picture

Fig. 10.5.1.2-2: PMGi input



10.5.1.3 Control

Connect the control cable from the generator here

representative picture

Fig. 10.5.1.3-1: Control



10.5.1.4 External PE/N Bridge

The PE/N Bridge can be installed here for RCD or removed for isolation control

representative picture

Fig. 10.5.1.4-1: External PE/N Bridge

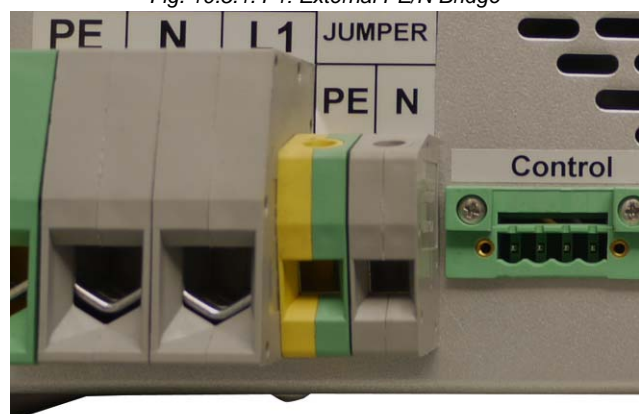

10.6 Back side - Top side

Inside of the PMGi a fan is mounted. The air holes and air grille should not be covered.

01. Air holes/Air grille - Do not cover

Fig. 10.6.0-1: Back side

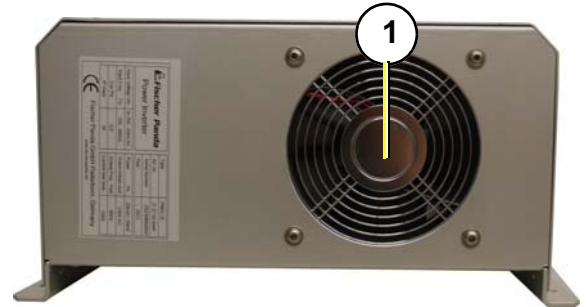

Inside of the PMGi are up to 550 VAC. The cover of the PMGi should only be opened by special trained persons! Danger for Live!

Attention!



Make sure that the connection between the generator and the PMGi is secured. Never connect or disconnect the PMGi while the generator is running. This will destroy the PMGi (it may burn or explode).

10.7 Settings for the use of iGenerators with power inverter

For the use of power inverter with the PMGi, the settings of the power inverter must be modified.

ATTENTION: Wrong settings can destroy the PMGi



Wrong settings can damage or destroy the PMGi.

The settings for the Victron power inverter must be adapted for the power inverters of other brands.

10.7.1 Settings in the Victron VE Configure II Software - General

Fig. 10.7.1-1: Settings in the Victron VE configure II Software

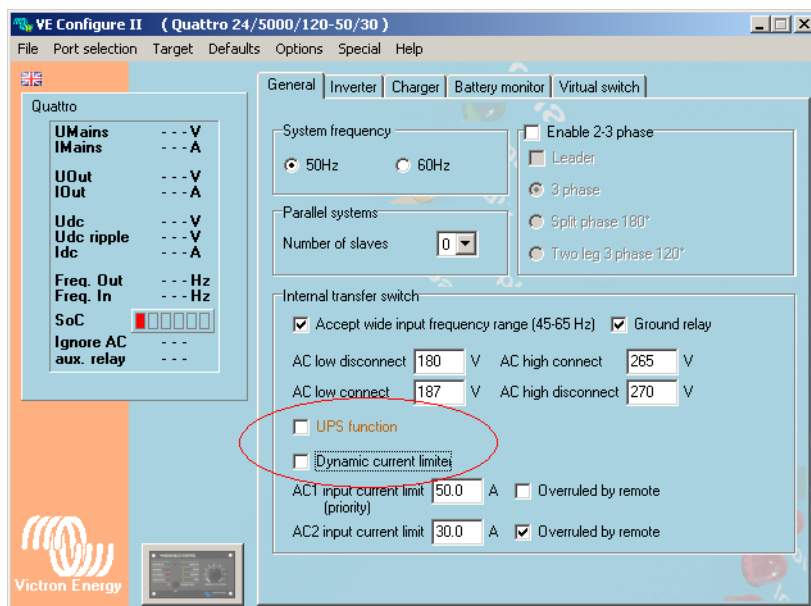

10.7.1.1 Uninterrupted AC power (UPS function)

Due to the fact that the power inverter connects the shore power immediately to the domestic grid (too fast), the PMGi gets overloaded and shut down with an error.

UPS Function must be deactivated.

10.7.1.2 Dynamic current limiter

With inductive load the dynamic current limiter will raise up the Voltage in the DC circuit. These over voltage can damage or destroy the PMGi.

Dynamic current limiter must be deactivated.

10.7.2 Settings in the Victron VE Configure II Software - Inverter

Fig. 10.7.2-1: Settings in the Victron VE configure II Software

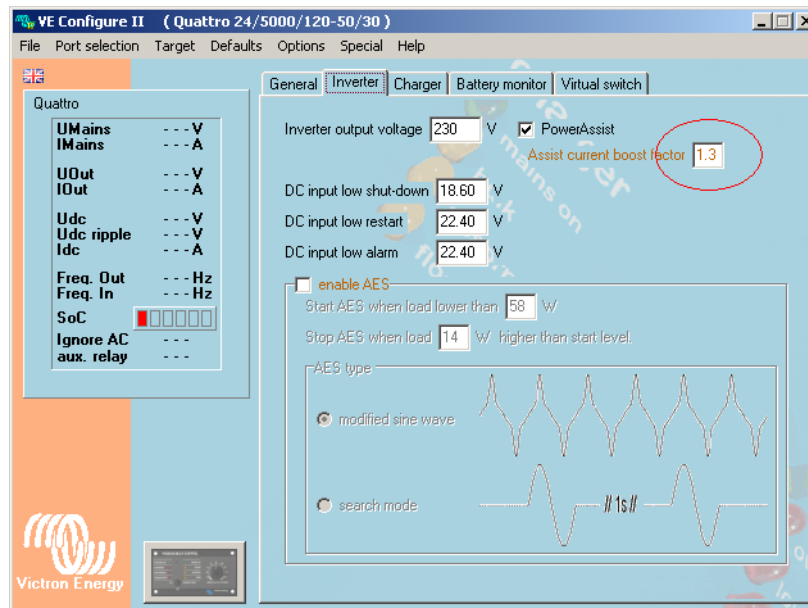

10.7.2.1 Assist current boost factor

To reduce the action of the power inverter on the iGenerator, the Assist current boost factor must be reduced from 2.0 to 1.3. Wrong settings will cause bad rpm control of the generator.

10.8 Operation manual

10.8.1 Primary remarks / Winter operation

The PMGi can operate in the range of -20 °C to +40 °C.

10.8.2 Load at the PMGi

Do not overload the PMGi. It will go on error.

10.8.3 Automatic start

The generator can start (depending on the remote control panel) by an external signal (automatic start)

If you use this option make sure that the load is connected to the PMGi after the output has reached the nominal 230 V / 50 Hz and not to overload the PMGi (some electronic devices, such like air conditions, need an higher start current). May use a relay which connect the load at the nominal voltage (f.e.120 V or 230 V.).

10.9 Status LEDs

Red - Green

LED - Red	Red LED lights for the very first seconds (about 10 sec) after the running of the engine. During this time no output is provided by the PMGi. Red LED starts to blink when an overload condition is reached. During this time the green LED continues to light. When an overload condition stays for too long the red LED stops blinking and stays permanently switched on, while the green LED switch off.
LED-Green	Green LED permanently lights alone when the PMGi output is available and it value stays in the specification

10.10 Cooling of the PMGi

Inside of the PMGi a fan is mounted.

Do not cover the air holes and grille.

The heat sink and the fan of the PMGi may become dirty as a consequence of the use of the generator, and so the unit can loose a part of their heat transfer characteristic. Every 6 months it is necessary to visual inspect the heat sinks and clean it with compressed air. At every Generator service the fan of the PMGi should be cleaned by the special trained person.

Water cooled PMGi has an additional cooling plate inside. These cooling plate must be connected to the cooling water circle.

10.11 Installation of the PMGi

The PMGi must be mounted vertical, with the electrical connection down. So you can read the writing on the PMGi. The surface where the PMGi is mounted should be smoothed and support the heat transfer. The Air holes and Air grille must be not covered and enough cooling air must be pleasant at any time for the PMGi.

To mount the PMGi use the fixing holes diameter 6,5mm.

See the safety instruction in your Generator and iControl Note! Manual.



The rules of the respective regional authority must be adhered to. Only an electrician may carry out installation of the electrical connections for safety reasons.

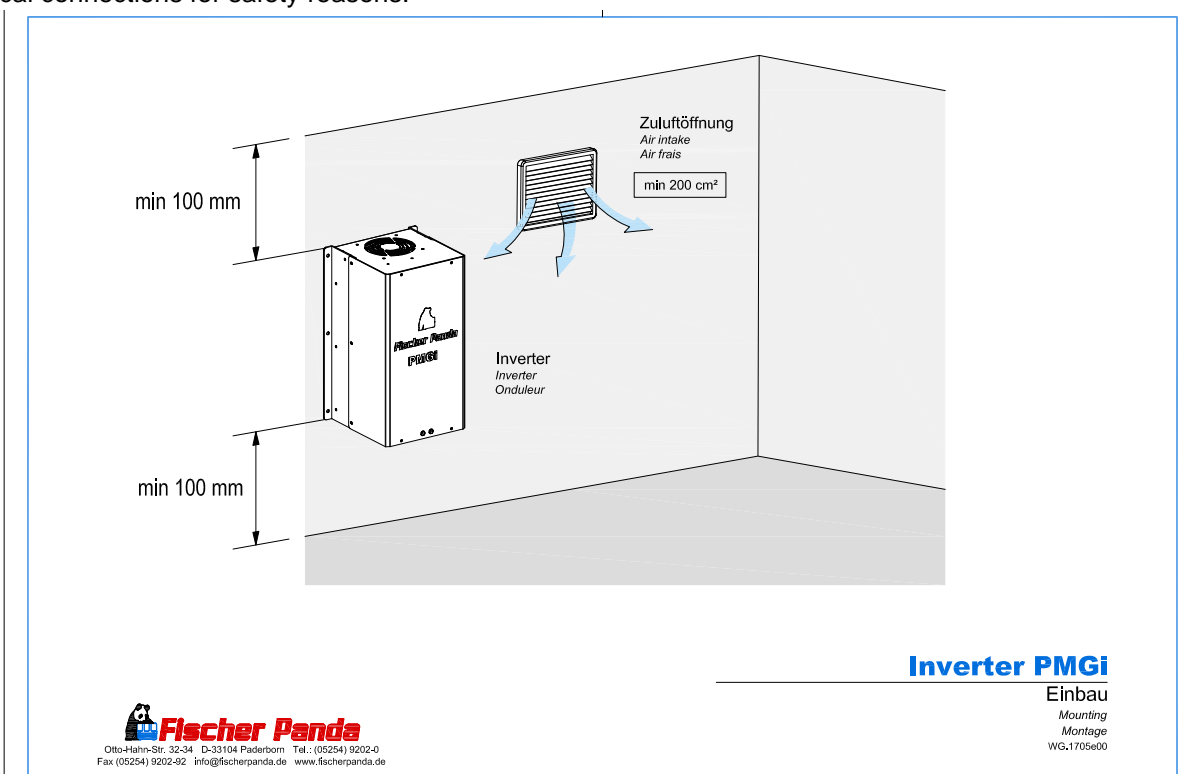

10.11.1 Cooling water connection schema - Vehicle Generator

10.11.1.1 Integration of a water cooled PMGi inverter into the cooling system.

The water cooled PMGi needs a separate cooling circle. Normal a small radiator net is attached to the bigger Generator Radiator. The circle has its own electrical water pump, which is powered by the generator.

10.11.1.2 Cooling water scheme if the Radiator is higher than the Generator /Inverter

Fig. 10.11.1.2-1: Cooling water scheme if the Radiator is higher than the Generator /Inverter

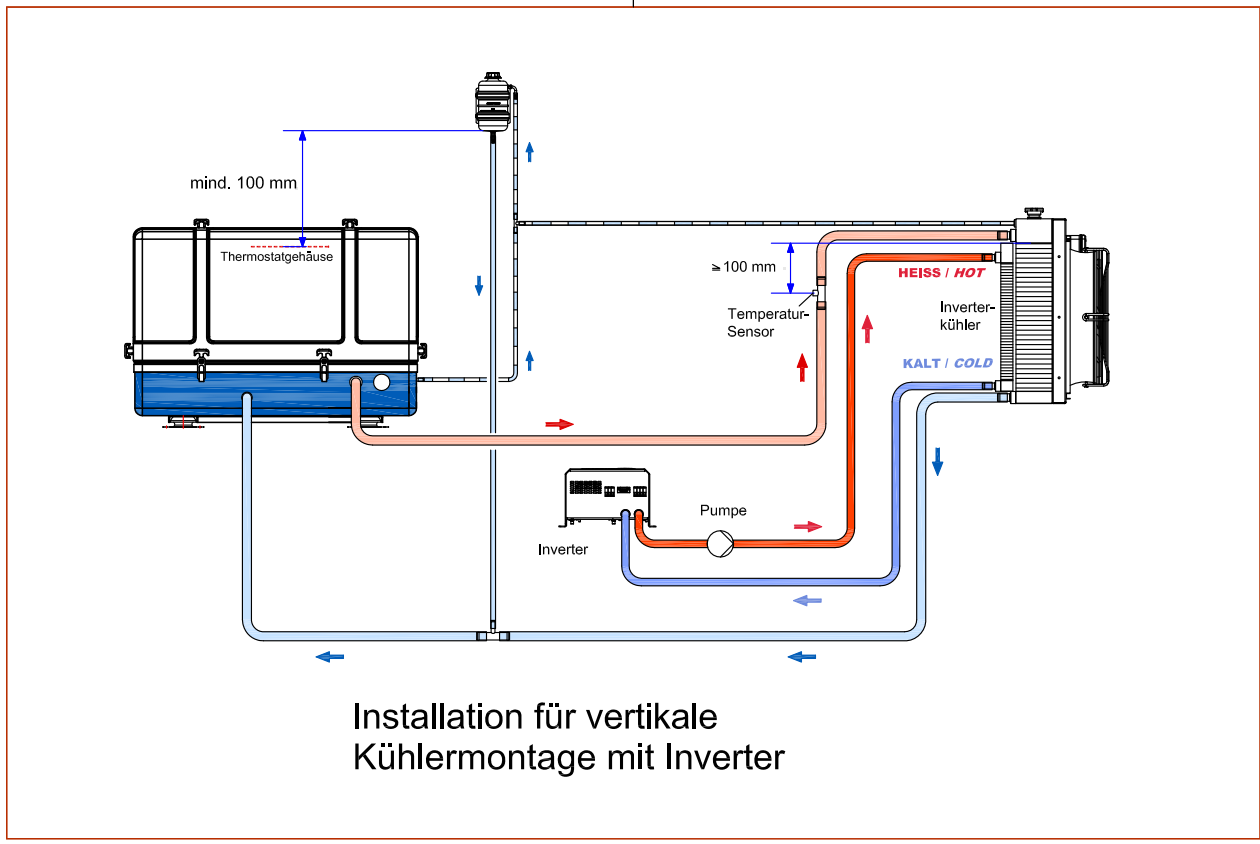

10.11.1.3 Cooling water scheme if the Radiator is on the same level or lower than the Generator /Inverter

Fig. 10.11.1-1: Cooling water scheme if the Radiator is on the same level or lower than the Generator /Inverter

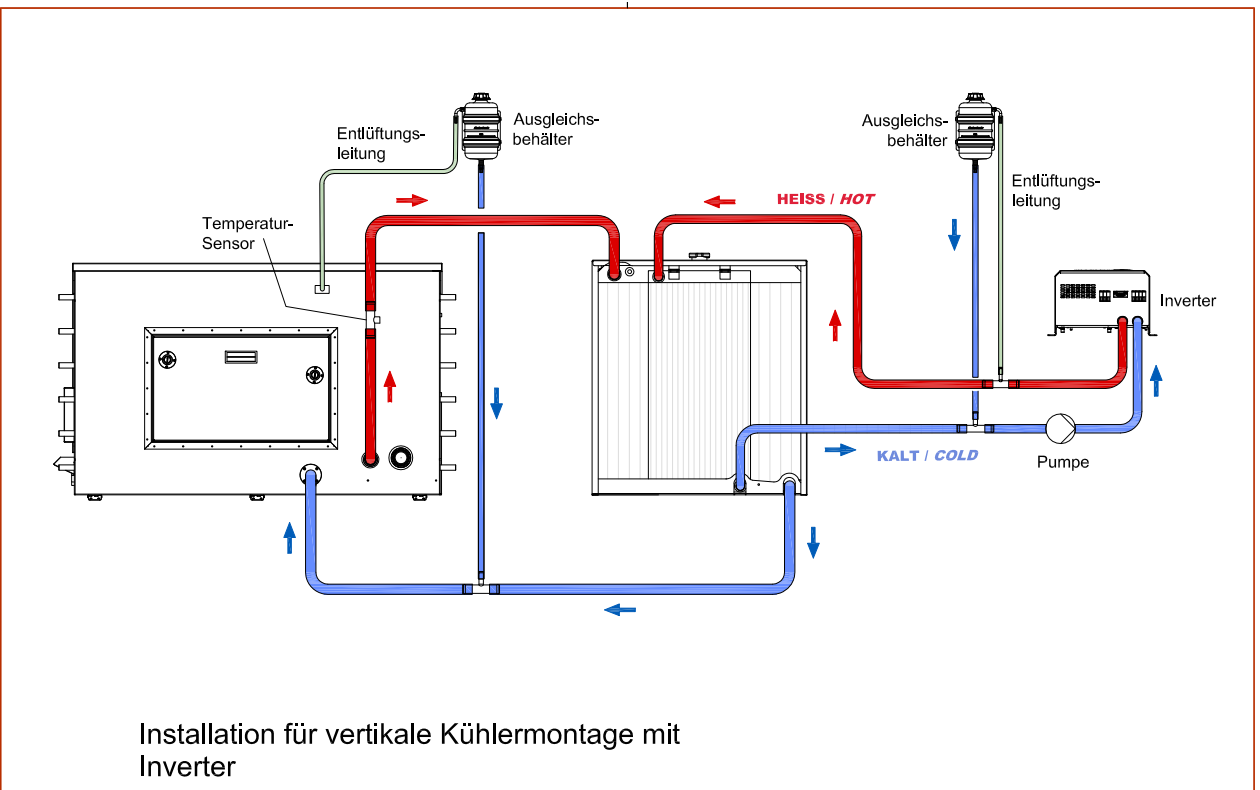
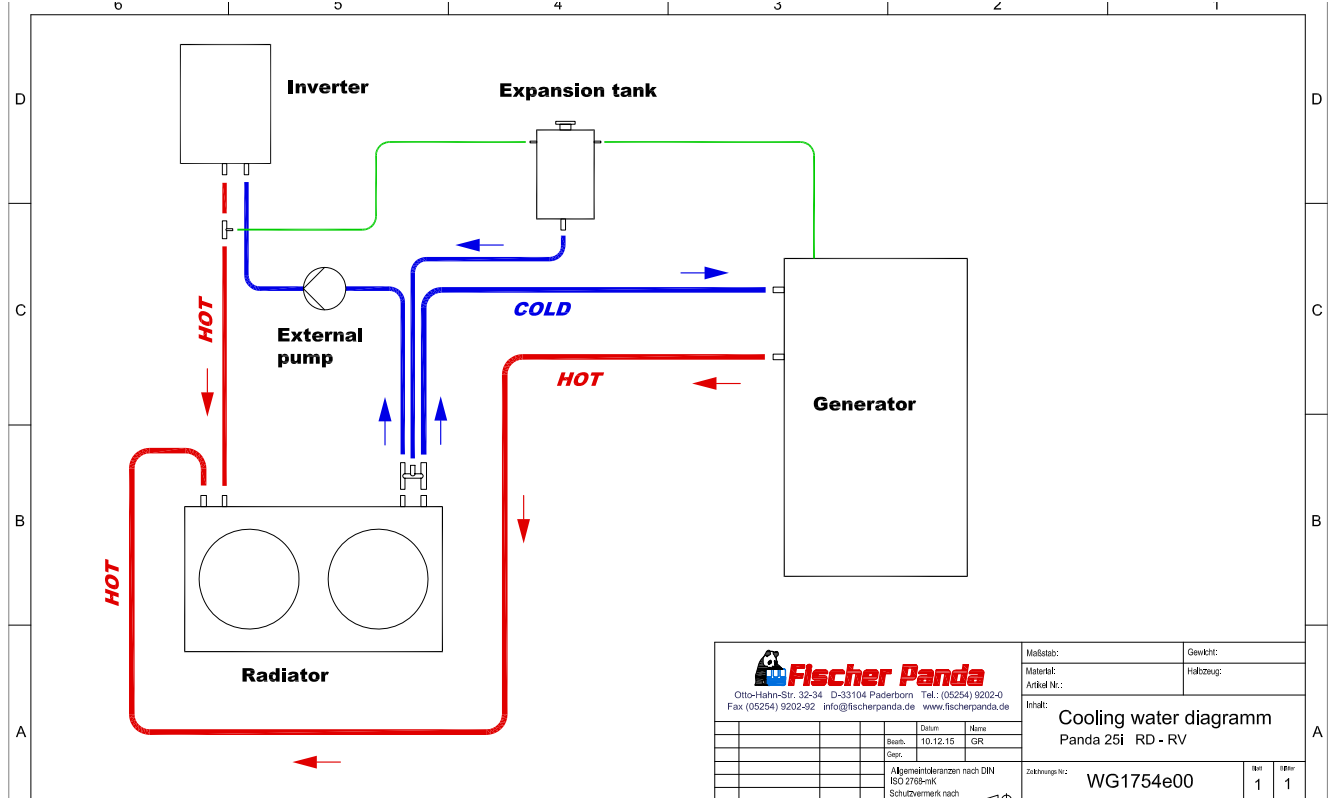
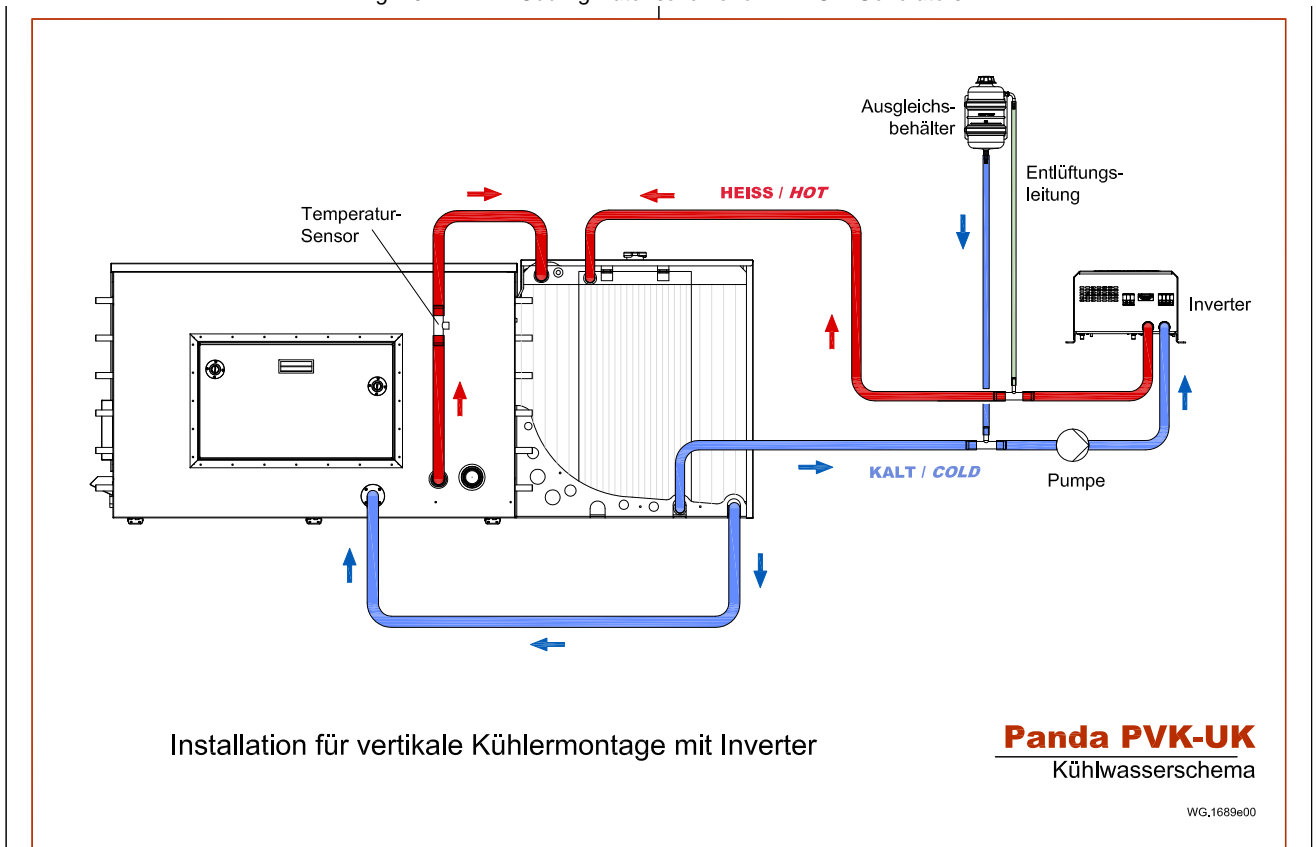

Fig. 10.11.1-2: Cooling water scheme if the Radiator is on the same level or lower than the Generator /Inverter



10.11.1.4 Cooling water scheme for PVK-UK iGenerators

Fig. 10.11.1.4-1: Cooling water scheme for PVK-UK iGenerators



10.11.1.5 Cooling water connection schema - Marine (PMS) Generator

Fig. 10.11.1.5-1: Cooling water connection schema - Marine (PMS) Generator

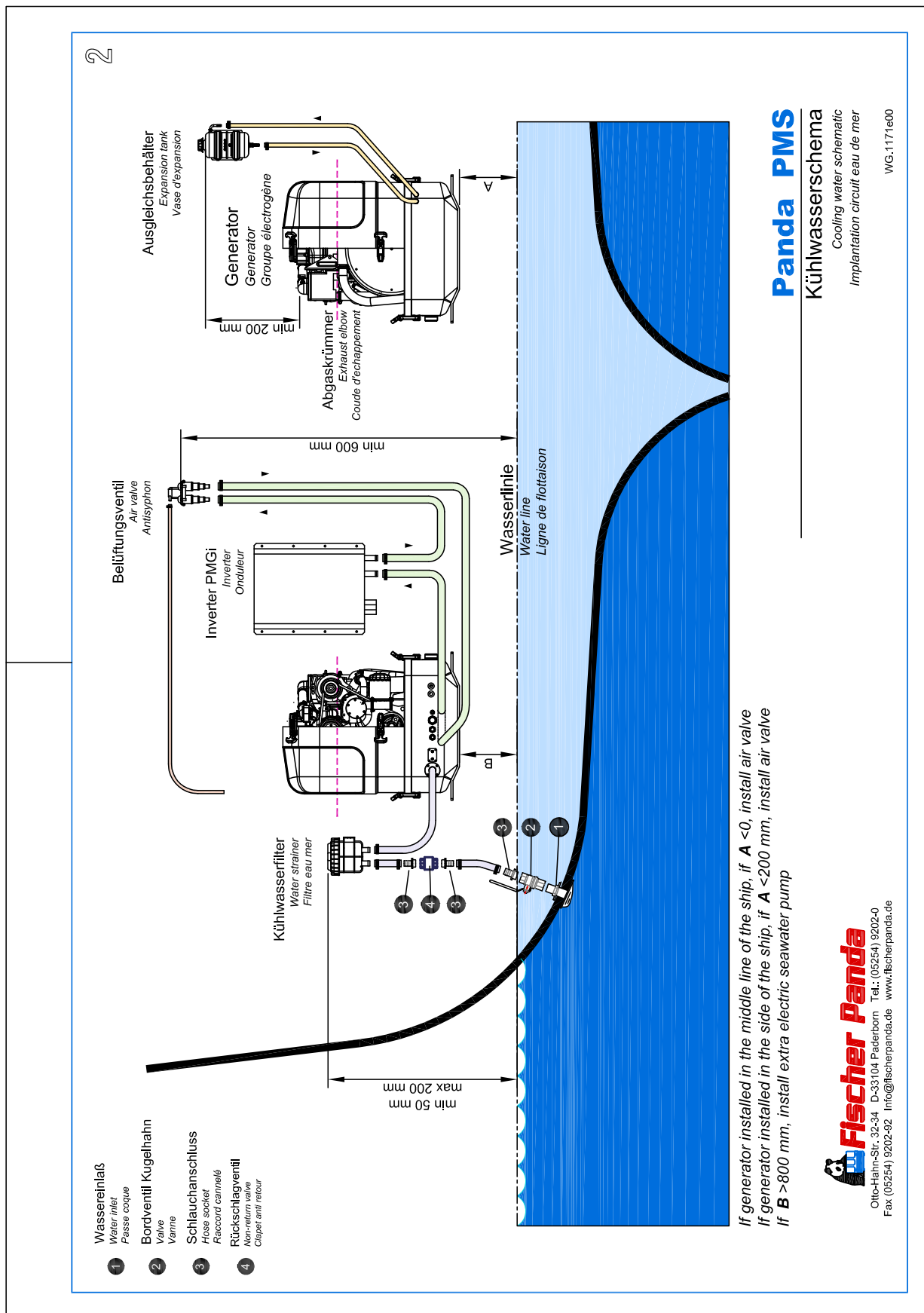

10.11.2 Electrical connection.

Only special trained persons are allowed to make the electrical connection.

When an extension cable is required, be sure to use a tough rubber sheeted flexible and fireproof cable. Limit length of extension cables depends on the voltage drop along the cable. This drop must be less than 2,5% value of the nominal output voltage.

Pay attention to the right pin assignment. See "Socket pins of the PMGi" on page 116.

10.11.2.1 Connection to a system with RCD at PMGi with PEN jumper

The PMGi is prepared for the use in a RCD protected grid.,

The PMGi out must be connected 1:1 (PE,N,L) to the customers electrical cabinet. The Life wire and neutral wire will be connected to the RCD. The PE will be connected to the PE of the electrical cabinet. After installation the function of the RCD must be tested.

PE-N Bridge

The PE-N bridge is installed in the prepared jumper terminal.

Fig. 10.11-1: PE-N bridge

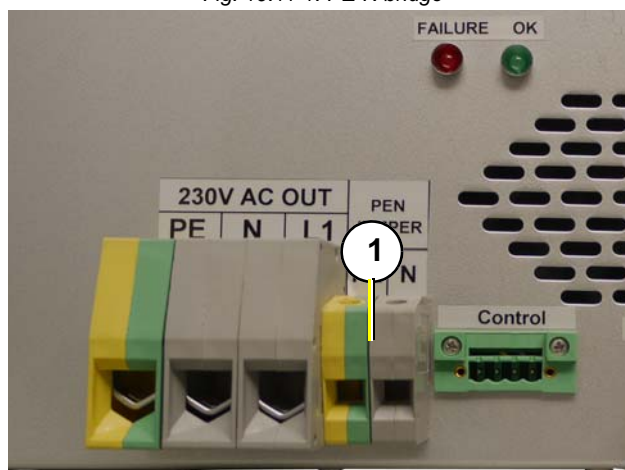

10.11.2.2 Connection to a system with RCD at PMGi without PEN jumper

The PMGi is prepared for the use in a RCD protected grid.,

The PMGi out must be connected 1:1 (PE,N,L) to the customers electrical cabinet. The life wire and neutral wire will be connected to the RCD. The PE will be connected to the PE of the electrical cabinet. After installation the function of the RCD must be tested.

PE-N Bridge

Inside of the PMGi a PE-N bridge is installed (1)

Fig. 10.11-1: PE-N bridge

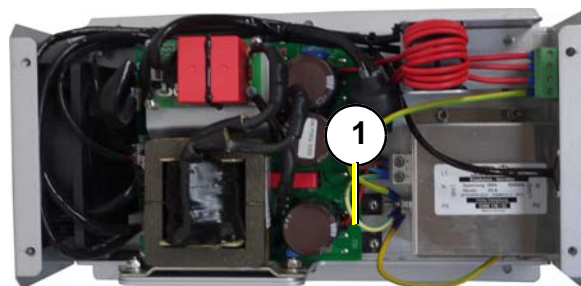

10.11.2.3 Connection to a system with isolation control at PMGi with PEN jumper

For the use of the PMGi with an isolation controlled grid, the external PE-N Bridge must be disconnected. PEN jumper open.

10.11.2.4 Connection to a system with isolation control at PMGi without PEN jumper

For the use of the PMGi with an isolation controlled grid, the internal PE-N Bridge must be disconnected.

A manual for this modification can be downloaded under:

http://www.fischerpanda.de/images/gensets/M_AC_50_INV_PMS_8000i/operatormanual/PMGi/Modification_PMGi_isolation_control.eng.pdf

10.12 Technical Data

10.12.1 General Data

PMGi is part of the Panda i-series generator. Its not allowed to be used with other generators or applications.

Storage temperature	PMGi	-20 °C to +55 °C
Working temperature	PMGi	Minimum: -20 °C Maximum: +40 °C Maximal internal temperature of the PMGi: +60 °C

10.12.2 Generator Specification

PMG Generator out	3 phase	
Voltage Phase	minimum 250 V AC	Maximum 550 V AC
Frequency	minimum 250 Hz	Maximum 650 Hz

10.12.3 PMGi out

Fig. 10.12.3-1: Technische Daten PMGi / Technical data PMGi / PMGi Out

		PMGi 4000 230 V	PMGi 5000 230 V	PMGi 5000 120 V
Nominale Ausgangsspannung Nominal Voltage Tension de sortie nominale:	NOV _{AC}	230 V VAC +/- 5 % ohne Last / without Load / sans charge	230 V VAC +/- 5 % ohne Last / without Load / sans charge	120 V VAC +/- 5 % ohne Last / without Load / sans charge
Regelung Regulation Réglage	R	5 %	5 %	5 %
Stabilität (Kurzzeit (30sec)) Stability (short term (30sec)) Stabilité (courte durée (30s))	D _s	5 %	5 %	5 %
Stabilität (Langzeit (4h)) Stability (Long term (4h)) Stabilité (longue durée (4h))	D _l	5 %	5 %	5 %
Spannungsabweichung Voltage offset Divergence de tension	V _{offset}	+5 V -20 °C bis +40 °C +5 V -20 °C to +40 °C +5 V -20 °C à +40 °C	+5 V -20 °C bis +40 °C +5 V -20 °C to +40 °C +5 V -20 °C à +40 °C	+5 V -20 °C bis +40 °C +5 V -20 °C to +40 °C +5 V -20 °C à +40 °C
Stromstärke Current Courant	Stromstärke _{Nominal} Current _{Nominal} Courant _{Nominal}	17.4 A @230V _{eff.}	17,4 A @230V _{eff.}	33 A @ 120V _{eff.}
	Stromstärke _{Maximum} Current _{Maximum} Courant _{Maximum}	19.5 A @ cos phi 0,8 @230 V _{eff.}	22 A @ cos phi 0,8 @230 V _{eff.}	42 A @ cos phi 0,8 @120 V _{eff.}
Leistung Power Puissance	Nominal Nominal power Nominale	4,3 kVA	5,0 kVA	5,0 kVA
	Dauer Long term	3,6 kW	3,6 kW	3,6 kW
Frequenz Frequency Fréquence	Nominale Frequenz Nominal Frequency Fréquence nominale	50 Hz +/-2 %	50 Hz +/-2 %	60 Hz +/-2 %
	Regulierung Regulation Réglage	4 %	4 %	4 %
	Stabilität (Kurzzeitig) (30 s) Stability (short term (30 s)) Stabilité (courte durée (30 s))	3 %	3 %	3 %
	Stabilität (Langzeit (4 h)) Stability (Long term (4 h)) Stabilité (longue durée (4 h))	3 %	3 %	3 %
Krestfaktor ¹⁾ Crestfactor ¹⁾ Facteur de crête		3:1	3:1	3:1
Empfohlene Absicherung Recommend protection fuse Sécurisation recommandée		20 A	25 A	40 A
Empfohlener Kabelquerschnitt Recommend cable cross Section de câble recommandée		2,5 mm ²	2,5 mm ²	6 mm ²
Umgebungstemperatur max. Ambient temperature		40 °C	40 °C	40 °C

1) Peak Strom darf den 3-fachen Nennstrom erreichen

1) Peak current is allowed to reach 3 times of the nominal current

Fig. 10.12.3-2: Technische Daten PMGi / Technical data PMGi / PMGi Out

		PMGi 8000 230 V	PMGi 8000 120 V	PMGi 10000 230 V
Nominale Ausgangsspannung Nominal Voltage Tension de sortie nominale:	NOV _{AC}	230 V VAC +/- 5 % ohne Last / without Load / sans charge	120 V VAC +/- 5 % ohne Last / without Load / sans charge	230 V VAC +/- 5 % ohne Last / without Load / sans charge
Regelung Regulation Réglage	R	5 %	5 %	5 %
Stabilität (Kurzzeit (30sec)) Stability (short term (30sec)) Stabilité (courte durée (30s))	D _s	5 %	5 %	5 %
Stabilität (Langzeit (4h)) Stability (Long term (4h)) Stabilité (longue durée (4h))	D _l	5 %	5 %	5 %
Spannungsabweichung Voltage offset Divergence de tension	V _{offset}	+5 V -20 °C bis +40 °C +5 V -20 °C to +40 °C +5 V -20 °C à +40 °C	+5 V -20 °C bis +40 °C +5 V -20 °C to +40 °C +5 V -20 °C à +40 °C	+5 V -20 °C bis +40 °C +5 V -20 °C to +40 °C +5 V -20 °C à +40 °C
Stromstärke Current Courant	Stromstärke _{Nominal} Current _{Nominal} Courant _{Nominal}	26,0 A @230 V _{eff.}	53 A @ 120 V _{eff.}	34,8 A @230 V _{eff.}
	Stromstärke _{Maximum} @230 V _{eff.} Current _{Maximum} @230 V _{eff.} Courant _{Maximum} @230 V _{eff.}	34 A @ cos phi 0,8 @230V _{eff.}	67 A @ cos phi 0,8 @120V _{eff.}	43,5 A @ cos phi 0,8 @230V _{eff.}
Leistung Power Puissance	Nominal Nominal power Nominale	8,0 kVA	8 kVA	10,0 kVA
	Dauer Long term	6,4 kW	6,4 kW	8,0 kW
Frequenz Frequency Fréquence	Nominale Frequenz Nominal Frequency Fréquence nominale	50 Hz +/-2 %	60 Hz +/-2 %	50 Hz +/-2 %
	Regulierung Regulation Réglage	4 %	4 %	4 %
	Stabilität (Kurzzeitig (30 s)) Stability (short term (30 s)) Stabilité (courte durée (30 s))	3 %	3 %	3 %
	Stabilität (Langzeit (4 h)) Stability (Long term (4 h)) Stabilité (longue durée (4 h))	3 %	3 %	3 %
Krestfaktor ¹⁾ Crestfactor ¹⁾ Facteur de crête		3:1	3:1	3:1
Empfohlene Absicherung Recommend protection fuse Sécurisation recommandée		32 A	63 A	40 A
Empfohlener Kabelquerschnitt Recommend cable cross Section de câble recommandée		4 mm ²	10 mm ²	6 mm ²
Umgebungstemperatur max. Ambient temperature		40 °C	40 °C	40 °C

1) Peak Strom darf den 3-fachen Nennstrom erreichen

1) Peak current is allowed to reach 3 times of the nominal current

Fig. 10.12.3-3: Technische Daten PMGi / Technical data PMGi / PMGi Out

		PMGi 10000 120 V		
Nominale Ausgangsspannung Nominal Voltage	NOV _{AC}	120 V VAC +/- 5 % ohne Last / without Load / sans charge		
Regelung Regulation	R	5 %		
Stabilität (Kurzzeit (30sec)) Stability (short term (30sec))	D _s	5 %		
Stabilität (Langzeit (4h)) Stability (Long term (4h))	D _l	5 %		
Spannungsabweichung Voltage offset Divergence de tension	V _{offset}	+5 V -20 °C bis +40 °C +5 V -20 °C to +40 °C +5 V -20 °C à +40 °C		
Stromstärke Current Courant	Stromstärke _{Nominal} Current _{Nominal} Courant _{Nominal}	66,7 A @ 120V _{eff.}		
	Stromstärke _{Maximum} Current _{Maximum} Courant _{Maximum}	83,3 A @ cos phi 0,8 @ 120 V _{eff.}		
Leistung Power Puissance	Nominal Nominal power Nominale	10,0 kVA		
	Dauer Long term Continue	8,0 kW		
Frequenz Frequency	Nominale Frequenz Nominal Frequency Fréquence nominale	60 Hz +/- 2 %		
	Regulierung Regulation Réglage	4 %		
	Stabilität (Kurzzeitig (30 s)) Stability (short term (30 s)) Stabilité (courte durée (30 s))	3 %		
	Stabilität (Langzeit (4 h)) Stability (Long term (4 h)) Stabilité (longue durée (4 h))	3 %		
Krestfaktor ¹⁾ Crestfactor ¹⁾ Facteur de crête		3:1		
Empfohlene Absicherung Recommend protection Fuse Sécurisation recommandée		80 A		
Empfohlener Kabelquerschnitt Recommend cable cross Section de câble recommandée		25 mm ²		
Wassertemperatur max. Water temperature max.		40 °C		
Umgebungstemperatur max. Ambient temperature		60 °C		

1) Peak Strom darf den 3-fachen Nennstrom erreichen
1) Peak current is allowed to reach 3 times of the nominal current

Fig. 10.12.3-4: Technische Daten PMGi / Technical data PMGi / PMGi Out

		PMGi 15000 400 V	PMGi 15000 230 V	PMGi 15000 120 V
Nominale Ausgangsspannung Nominal Voltage	NOV _{AC}	400 V VAC +/- 5 % ohne Last / without Load / sans charge	230 V VAC +/- 5 % ohne Last / without Load / sans charge	120 V VAC +/- 5 % ohne Last / without Load / sans charge
Regelung Regulation	R	5 %	5 %	5 %
Stabilität (Kurzzeit (30sec)) Stability (short term (30sec))	D _s	5 %	5 %	5 %
Stabilität (Langzeit (4h)) Stability (Long term (4h))	D _l	5 %	5 %	5 %
Spannungsabweichung Voltage offset Divergence de tension	V _{offset}	+5 V -20 °C bis +40 °C +5 V -20 °C to +40 °C +5 V -20 °C à +40 °C	+5 V -20 °C bis +40 °C +5 V -20 °C to +40 °C +5 V -20 °C à +40 °C	+5 V -20 °C bis +40 °C +5 V -20 °C to +40 °C +5 V -20 °C à +40 °C
Stromstärke Current Courant	Stromstärke _{Nominal} Current _{Nominal} Courant _{Nominal}	3x 17,4 A @ 400 V _{eff.}	52 A @ 230V _{eff.}	100 A @ 120V _{eff.}
	Stromstärke _{Maximum} Current _{Maximum} Courant _{Maximum}	3x 21,7 A @ cos phi 0,8 @ 400 V _{eff.}	52 A @ cos phi 0,8 @ 230 V _{eff.}	100 A @ cos phi 0,8 @ 120 V _{eff.}
Leistung Power Puissance	Nominal Nominal power Nominale	15 kVA	15 kVA	15 kVA
	Dauer Long term Continue	10,8 kW	12 kW	12 kW
Frequenz Frequency	Nominale Frequenz Nominal Frequency Fréquence nominale	50 Hz +/- 2 %	50 Hz +/- 2 % 60 Hz +/- 2 %	60 Hz +/- 2 %
	Regulierung Regulation Réglage	4 %	4 %	4 %
	Stabilität (Kurzzeitig) (30 s) Stability (short term (30 s)) Stabilité (courte durée (30 s))	3 %	3 %	3 %
	Stabilität (Langzeit) (4 h) Stability (Long term (4 h)) Stabilité (longue durée (4 h))	3 %	3 %	3 %
Krestfaktor 1) Crestfactor 1) Facteur de crête		3:1	3:1	3:1
Empfohlene Absicherung Recommend protection Fuse Sécurisation recommandée		3x 25 A	63 A	100 A
Empfohlener Kabelquerschnitt Recommend cable cross Section de câble recommandée		4 mm ² (PUR Kabel einsetzen / use PUR cable / Mise en place du câble PUR)	10 mm ² (PUR Kabel einsetzen / use PUR cable / Mise en place du câble PUR)	25 mm ² (PUR Kabel einsetzen / use PUR cable / Mise en place du câble PUR)
Wassertemperatur max. Water temperature max.			40 °C (nur bei wassergekühlter Version / watercooled version only)	40 °C
Umgebungstemperatur max. Ambient temperature		40 °C (nur bei wassergekühlter Version / watercooled version only)	60 °C (nur bei wassergekühlter Version / watercooled version only)	60 °C

1) Peak Strom darf den 3-fachen Nennstrom erreichen

1) Peak current is allowed to reach 3 times of the nominal current

Fig. 10.12.3-5: Technische Daten PMGi / Technical data PMGi / PMGi Out

		PMGi 25 230 V	PMGi 25 400 V	PMGi 25 2x120 V/240 V
Nominale Ausgangsspannung Nominal Voltage	NOV _{AC}	230 V VAC +/- 5 % ohne Last / without Load / sans charge	400 V VAC +/- 5 % ohne Last / without Load / sans charge	2x120 V/240 V VAC +/- 5 % ohne Last / without Load / sans charge
Regelung Regulation	R	5 %	5 %	5 %
Stabilität (Kurzzeit (30sec)) Stability (short term (30sec))	D _s	5 %	5 %	5 %
Stabilität (Langzeit (4h)) Stability (Long term (4h))	D _l	5 %	5 %	5 %
Spannungsabweichung Voltage offset Divergence de tension	V _{offset}	+5 V -20 °C bis +40 °C +5 V -20 °C to +40 °C +5 V -20 °C à +40 °C	+5 V -20 °C bis +40 °C +5 V -20 °C to +40 °C +5 V -20 °C à +40 °C	+5 V -20 °C bis +40 °C +5 V -20 °C to +40 °C +5 V -20 °C à +40 °C
Stromstärke Current Courant	Stromstärke _{Nominal} Current _{Nominal} Courant _{Nominal}	87 A @230V	3x29 A @400V	2x 83,3 A@120 V/ 1x 83,3 A@240 V
	Stromstärke _{Maximum} Current _{Maximum} Courant _{Maximum}	108 A @ cos phi 0,8 @230 V	3x36,2 A @ cos phi 0,8 @400 V	2x 104,0 A @ cos phi 0,8 @120 V 1x 104,0 A @ cos phi 0,8 @240 V
Leistung Power Puissance	Nominal Nominal power Nominale	25 kVA	25 kVA	25 kVA
	Dauer Long term Continue	18 kW	20 kW	2x 10 kW @120 V 1x 20 kW @240 V
Frequenz Frequency	Nominale Frequenz Nominal Frequency Fréquence nominale	50 Hz +/- 2 %	50 Hz +/- 2 % (Alternative 60 Hz +/- 2 % on special order)	60 Hz +/- 2 %6
	Regulierung Regulation Réglage	4 %	4 %	4 %
	Stabilität (Kurzzeitig) (30 s) Stability (short term (30 s)) Stabilité (courte durée (30 s))	3 %	3 %	3 %
	Stabilität (Langzeit (4 h)) Stability (Long term (4 h)) Stabilité (longue durée (4 h))	3 %	3 %	3 %
Krestfaktor ¹⁾ Crestfactor ¹⁾ Facteur de crête		3:1	3:1	3:1
Empfohlene Absicherung Recommend protection Fuse Sécurisation recommandée		125 A	40 A	125 A
Empfohlener Kabelquerschnitt Recommend cable cross Section de câble recommandée		35 mm ²	6 mm ²	50 mm ²
Wassertemperatur max. Water temperature max.		40 °C	40 °C	40 °C
Umgebungstemperatur max. Ambient temperature		60 °C	50 °C	60 °C

1) Peak Strom darf den 3-fachen Nennstrom erreichen
1) Peak current is allowed to reach 3 times of the nominal current

Fig. 10.12.3-6: Technische Daten PMGi / Technical data PMGi / PMGi Out

		PMGi 45 230 V	PMGi 45 400 V	PMGi 60 400 V
Nominale Ausgangsspannung Nominal Voltage	NOV _{AC}	230 V VAC +/- 5 % ohne Last / without Load / sans charge	400 V VAC +/- 5 % ohne Last / without Load / sans charge	400 V VAC +/- 5 % ohne Last / without Load / sans charge
Regelung Regulation	R	5 %	5 %	5 %
Stabilität (Kurzzeit (30sec)) Stability (short term (30sec))	D _s	5 %	5 %	5 %
Stabilität (Langzeit (4h)) Stability (Long term (4h))	D _l	5 %	5 %	5 %
Spannungsabweichung Voltage offset Divergence de tension	V _{offset}	+5 V -20 °C bis +40 °C +5 V -20 °C to +40 °C +5 V -20 °C à +40 °C	+5 V -20 °C bis +40 °C +5 V -20 °C to +40 °C +5 V -20 °C à +40 °C	+5 V -20 °C bis +40 °C +5 V -20 °C to +40 °C +5 V -20 °C à +40 °C
Stromstärke Current Courant	Stromstärke _{Nominal} Current _{Nominal} Courant _{Nominal}	156,5 @230V	3x52 A @400V	3x69,3 A @400V
	Stromstärke _{Maximum} Current _{Maximum} Courant _{Maximum}	195,6 A @ cos phi 0,8 @230 V	65 A @ cos phi 0,8 @400 V	86,7 A @ cos phi 0,8 @400 V
Leistung Power Puissance	Nominal Nominal power Nominale	45 kVA	45 kVA	60 kVA
	Dauer Long term Continue	Dauer 36 kW	Nominal 36 kW Dauer 33 kW	Nominal 48 kW Dauer 43 kW
Frequenz Frequency	Nominale Frequenz Nominal Frequency Fréquence nominale	50 Hz +/- 2 % (Alternative 60 Hz +/- 2 % on special order)	50 Hz +/- 2 % (Alternative 60 Hz +/- 2 % on special order)	50 Hz +/- 2 % (Alternative 60 Hz +/- 2 % on special order)
	Regulierung Regulation Réglage	4 %	4 %	4 %
	Stabilität (Kurzzeit (30 s)) Stability (short term (30 s)) Stabilité (courte durée (30 s))	3 %	3 %	3 %
	Stabilität (Langzeit (4 h)) Stability (Long term (4 h)) Stabilité (longue durée (4 h))	3 %	3 %	3 %
Krestfaktor 1) Crestfactor 1) Facteur de crête		3:1	3:1	3:1
Empfohlene Absicherung Recommend protection Fuse Sécurisation recommandée		200 A	80 A	100 A
Empfohlener Kabelquerschnitt Recommend cable cross Section de câble recommandée		50 mm ² (PUR Kabel einsetzen / use PUR cable / Mise en place du câble PUR)	min. 16 mm ² (PUR Kabel einsetzen / use PUR cable / Mise en place du câble PUR)	min. 35 mm ² (PUR Kabel einsetzen / use PUR cable / Mise en place du câble PUR)
Wassertemperatur max. Water temperature max.		40 °C (nur bei wassergekühlter Version / watercooled version only)	40 °C (nur bei wassergekühlter Version / watercooled version only)	40 °C (nur bei wassergekühlter Version / watercooled version only)
Umgebungstemperatur max. Ambient temperature		50 °C (nur bei wassergekühlter Version / watercooled version only)	50 °C (nur bei wassergekühlter Version / watercooled version only)	50 °C (nur bei wassergekühlter Version / watercooled version only)

1) Peak Strom darf den 3-fachen Nennstrom erreichen

1) Peak current is allowed to reach 3 times of the nominal current

Fig. 10.12.3-7: Overload

Art of output	Max. current	Comment
230 VAC	87 A +/- 0.5 A	after the overload protection was activated, the generator must be switched off and all load must be disconnected.

10.13 PMGi protections

10.13.1 Short circuit

To operate the short circuit protection a fuse must be put in series with the live wire. The minimum requested feature for this fuse are the following.

1.2	1.5	2.75	4.0	10.0
>1 h	<30 min	5 ms to 150 ms	2 ms to 15 ms	<2 ms

The electrical Data reference to the „General Specifications“. Do not submit the PMGi a temperature shock.

Note!



Leere Seite / Intentionally blank



Fischer Panda®

Power
wherever
you are™



Panda iControl2

Operating Manual

Open-loop and closed-loop control system for Fischer Panda generators



Current revision status

	Document
Current:	Panda iControl2_eng.R08_4.5.16
Replaces:	Panda iControl2_eng.R07

Revision	Page
Kontrolltätigkeiten vor dem Start eingefügt	
Emergency stop, Fehlerspeicher, Master Slave eingepflegt R08	

Hardware

Generator	Revision	Modification Strike Plate	Date	Upgrade

Created by

Fischer Panda GmbH - Head of Technical Documentation

Otto-Hahn-Str. 32-34

33104 Paderborn - Germany

Phone: +49 (0) 5254-9202-0

E-mail: info@fischerpanda.de

web: www.fischerpanda.de

Copyright

Reproduction and modification of the manual is permitted only after agreement with the manufacturer!

Fischer Panda GmbH, 33104 Paderborn, reserves all rights regarding text and graphics in this document. Details are given to the best of our knowledge. No liability is accepted for correctness. Please note: technical modifications aimed at improving the product may be implemented without prior notice. Therefore, it must be ensured prior to installation that the pictures, diagrams and related material are applicable to the genset supplied. In case of doubt, verify upon delivery that documentation and equipment match.



Fischer Panda GmbH
 Otto-Hahn-Str. 40
 D-33104 Paderborn
 Germany

Tel. : +49 (0)5254 9202-0
 Fax. : +49 (0)5254 9202-550
 Hotline : +49 (0)5254 9202-767
 Email : info@fischerpanda.de
 Web : www.fischerpanda.de



11. Safety instructions for the Panda iControl2

11.1 Personnel

The settings described here can be performed by the operator unless highlighted differently.

The installation should be implemented by specially trained technical personnel or by authorised workshops (Fischer Panda Service Points), only.

11.2 Safety instructions

Ensure compliance with the safety instructions in the Fischer Panda genset manual.

NOTE:

If these instructions are not on hand, they can be requested from Fischer Panda GmbH, 33104 Paderborn, Germany.



An external signal may trigger an automatic start-up.

WARNING: Automatic start-up



The generator must not be operated with the cover removed.

WARNING:



If the generator is being installed without a sound insulation capsule, it must be ensured that all rotating parts (belt pulley, belts etc.) are covered and protected so that there is no danger to life and body!

If a sound insulation capsule will be produced at the place of installation, then well-placed signs must show that the generator can only be switched on with the capsule closed.

All service, maintenance, or repair work may only be carried out when the unit is not running.

Electric voltage - DANGER TO LIFE!

WARNING: Electric voltage

Electric voltages of more than 60V are potentially lethal in any situation. The rules of the respective regional authority must be adhered to for installation and maintenance.



For safety reasons, only an electrician may carry out the installation of the electrical connections of the generator.

Disconnect battery before working on the generator

WARNING:



The battery must always be disconnected (first the negative terminal, then the positive terminal) if work on the generator or electrical system is to be carried out, so that the generator cannot be unintentionally started.

This applies in particular to systems with an automatic start-up function. The automatic start-up function shall be deactivated before starting work.

The flooding valve must be closed. (For PMS version only.)

Also observe the safety instructions for the other components of your system.

NOTE:



12. General operation

12.1 The Panda iControl2 panel

The "Panda iControl2 panel" control panel is the control and display unit for the Panda iControl2 control system and represents the interface between the user and the Panda iControl2 controller. The integrated display serves to present the most important data of the system as well as warnings and error messages.

The control panel is equipped with four buttons for operating the Panda iControl2 controller:

Fig. 12.1-1: Panda iControl 2 panel

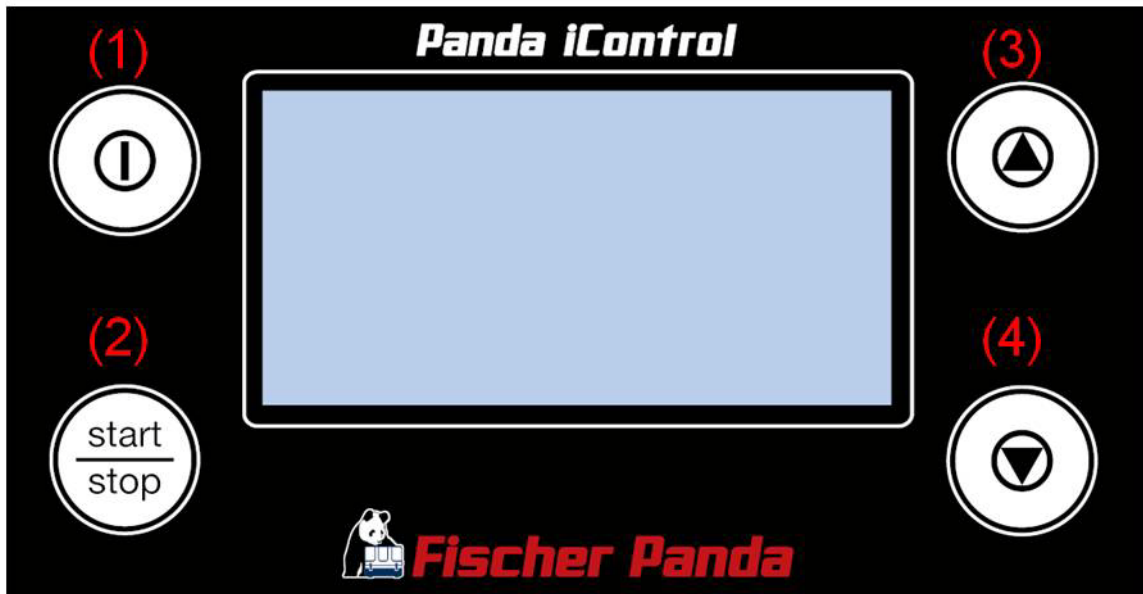

1. *On/Off button*: Switching the Panda iControl2 controller on and off
2. *Start/Stop button*: Starting and stopping the generator, confirming values in selection menus (Enter key)
3. *Cursor-up button*: Switching between display screens (up), counting values up in selection menus
4. *Cursor-down button*: Switching between display screens (down), counting values down in selection menus.

12.2 Starting preparation / Checks (daily)

12.2.1 Marine version

1. Oil level control (ideal level: 2/3 MAX).

The level should be about 2/3 of the maximum level of a cold engine.

Further, if installed, the oil level of the oil-cooled bearing must be controlled before each start - see sediment bowl at generator front cover!.

2. State of cooling water.

The external expansion tank should be filled up to 1/3 of the maximum in a cold state. It is very important that a large expansion area remains above the cooling water level.

3. Check if sea cock for cooling water intake is open.

For safety reasons, the sea cock must be closed after the generator has been switched off. It should be re-opened before starting the generator.

4. Check raw water filter.

The raw water filter must be regularly checked and cleaned. The impeller fatigue increases, if residual affects the raw water intake.

5. Visual inspection.

Control fixing bolts, check hose connectors for leakages, control electrical connections.

6. Switch off the load.

The generator should only be started without load.

7. Open fuel valve, if installed.

8. Close battery main switch (on).

12.2.2 Vehicle version

1. Oil level control (ideal level: 2/3 MAX).

The level should be about 2/3 of the maximum level of a cold engine.

Further, if installed, the oil level of the oil-cooled bearing must be controlled before each start - see sediment bowl at generator front cover!.

2. State of cooling water.

The external expansion tank should be filled up to 1/3 of the maximum in a cold state. It is very important that a large expansion area remains above the cooling water level.

3. Visual inspection.

Control fixing bolts, check hose connectors for leakages, control electrical connections.

4. Switch off the load.

The generator should only be started without load.

5. Open fuel valve, if installed.

Close battery main switch (on).

12.3 Operation

12.3.1 Switching the controller on and off

The Panda iControl2 controller is switched on and off with the On/Off button on the Panda iControl2 panel. Press and hold the On/Off button until the start screen with the panda bear appears on the display. The controller is switched off by actuating the On/Off button once more.

On the start screen, the hardware version, the generator type, and the software version are shown at the bottom left.

Fig. 12.3.1-1: .Panda iControl2 start screen



Fig. 12.3.1-2: Hardware version, generator type, and software version in default display

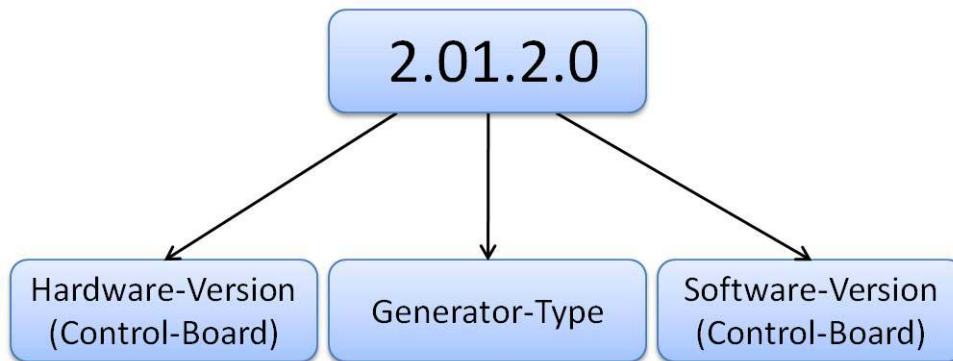

Example:

Hardware version:2 à iControl2 controller

Generator type:01 à Panda 5000i PMS

Software version: 2.0 à iControl2, compatible with iControl-Panel2

Note:



12.3.2 The default display screen

Five seconds after the controller is switched on, the display will change to the default display screen. On the default display screen, you will find information on the battery voltage, operating hours of the generator, temperatures of cylinder head, exhaust manifold, and winding, RPM, and the oil pressure status. Also, a bar graph display at the right hand edge of the display shows the utilisation of the generator in percent.

Data output on the default display screen:

- Battery voltage (supply voltage)
- Status field for operating modes (stand-by, pre-heat, starting, override, running, autostart, stopping)
- Operating hours of the generator

- Oil pressure status
- Cylinder head temperature
- Temperature of exhaust manifold
- Winding temperature
- Speed/RPM
- Utilisation in percent

Fig. 12.3.2-1: Default display screen

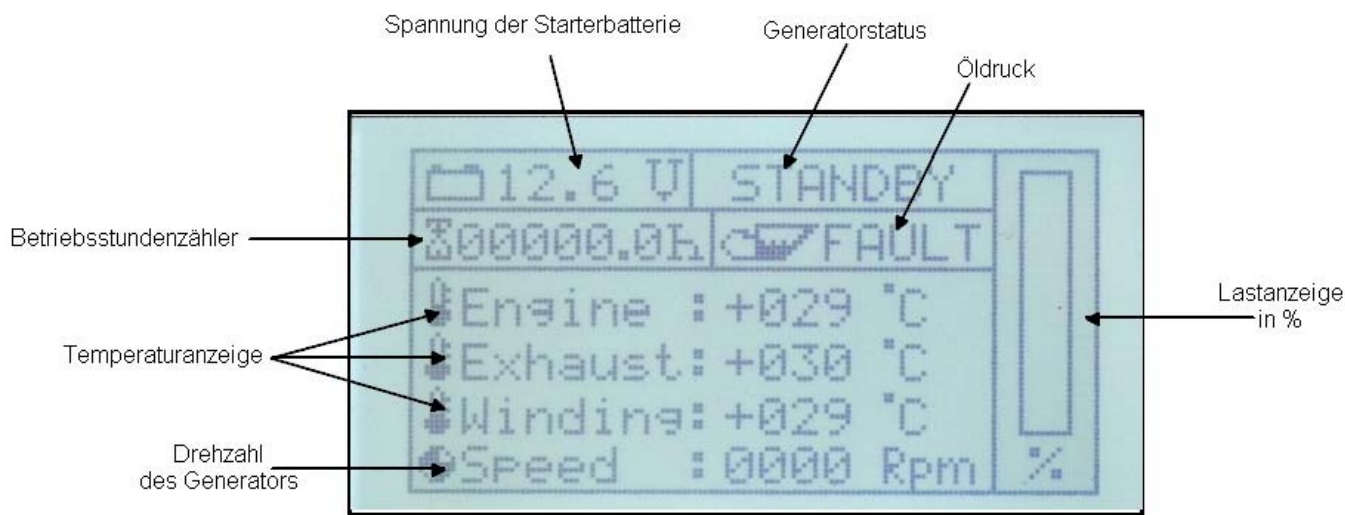

The Display shows the iControl board input voltage.

Note:

At generator systems with 12 V starter system these is equal with the starter battery voltage.



At generator system with 24 V starter system the starter battery voltage can not be displayed.

12.3.3 Operating modes

The Panda iControl2 controller offers different operating modes.

12.3.3.1 Stand-by mode

After the controller is switched on with the On/Off button, the system is in stand-by mode. This is indicated by the output "STANDBY" in the status field in the top right corner of the default display screen. In this operating mode, the system can be switched off with the On/Off button, and the generator can be started up with the Start/Stop button. With the cursor buttons, the service information screen can be accessed.

Fig. 12.3.3.1-1: Service information screen

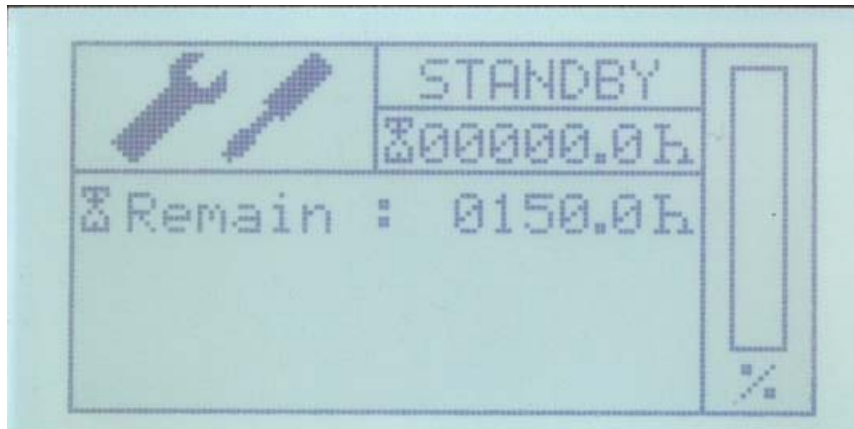

The total operating hours of the generator are given on the default display screen and on the service information screen. By actuating the cursor-up and cursor-down button in stand-by mode, the service screen can be accessed. This screen is marked with a screwdriver/spanner symbol. Here, the time until the next service is given. By actuating the cursor-up or cursor-down button, you can return to the default screen.

With the dynamic operation hours the service interval can be raised up to 30% (200h max.). Make sure that the dynamic operation hours are not reset accidentally between the service interval. see "Resetting the service interval ("Service")" on page 155.

Note:



In the set-up menu of the controller, you can reset the service interval after performing maintenance. Siehe "Set-up menu" auf Seite 151.

12.3.3.2 Start-up mode

The start-up mode represents the transition from stand-by mode to operation mode, i.e., generator operation. By actuating the Start/Stop button in stand-by mode, you can initiate the start-up process of the generator.

The pre-heating is the first step. During this stage, the status field at the top right of the default display screen shows the word "PREHEAT".

The pre-heating is always implemented for a duration of 10 seconds, regardless of the cylinder head temperature.

In temperatures below 0°C, the pre-heating time is always 40 seconds.

Fig. 12.3.3.2-1: Default display screen during pre-heating

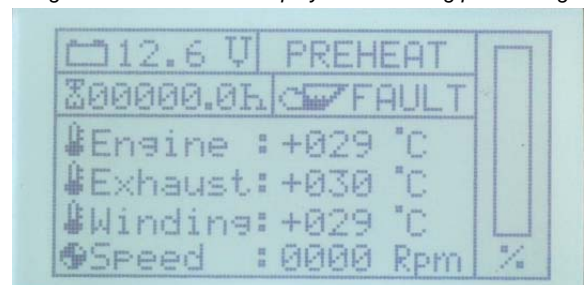

After pre-heating, the starter is initiated, accompanied by the text output "STARTING" in the status field of the default display screen.

Fig. 12.3.3.2-2: Default display screen during start-up



The controller will only perform one starting attempt. If the generator could not be started, the text output "STARTING FAILS" informs you of the failure of the generator starting attempt.

Note:



Acknowledging the message with the cursor-up, cursor-down, or the Start/Stop button on the Panda iControl2 panel will return the system to stand-by mode.

If there is difficulty in starting - close the seacock (Panda Marine Generators only) **ATTENTION:**



If the generator engine does not start immediately and further start attempts are necessary, then the seacock MUST be closed (i.e. for ventilating the fuel lines ect.) The cooling water impeller pump turns automatically and draws cooling water as long as the motor is turning. If the diesel motor is running, the cooling water is blown out by the exhaust system gases. The cooling water cannot be pressed through the exhaust as long as the diesel motor does not run at sufficient speed. This leads to severe motor damage.

Open the sea valve as soon as the generator is started.

12.3.3.3 Override mode

The override mode follows directly after the successful start-up of the generator. In this mode, no fault analysis is performed. The duration of the override mode is 10 seconds. The status indicator on the display reads "OVERRIDE".

Fig. 12.3.3.3-1: Default display screen in override mode

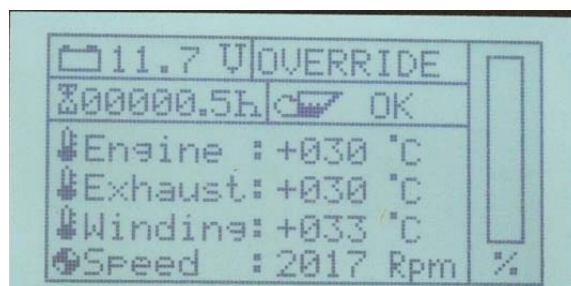

12.3.3.4 Operation mode

Operation mode signifies the operating mode in which the generator is running and all operating data are within their normal range. The status field of the default display screen shows "RUNNING".

In operation mode, the electrical load is given on the right hand side of the default display screen and in the inverter screen as a bar graph. The bar graph merely provides a guide value for the load of the generator and gives the values as a percentage.

Fig. 12.3.3.4-1: Default display screen in operation mode



Display screen for single phase generators

With the single phase i-series generators, there is an additional screen in operation mode for the inverter data. This screen provides the current inverter output voltage and the inverter temperature. You can access the inverter screen by actuating the cursor-up button while in operation mode.

Fig. 12.3.3.4-2: Inverter screen in operation mode

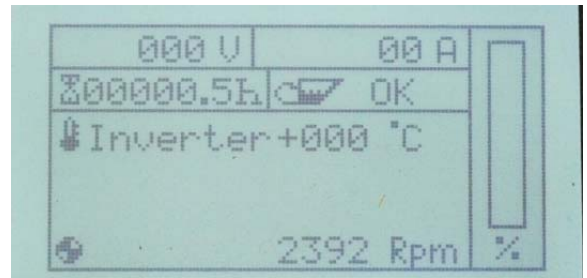

Display screens for 3-phase generators

With the 3-phase i-series generators, there are 5 additional screen in operation mode for the inverter data. This screen provides the inverter coil-voltage and the conductor current. You can access the inverter screen by actuating the cursor-up button while in operation mode.

Fig. 12.3.3.4-3: Inverter screen coil-voltage and conductor current

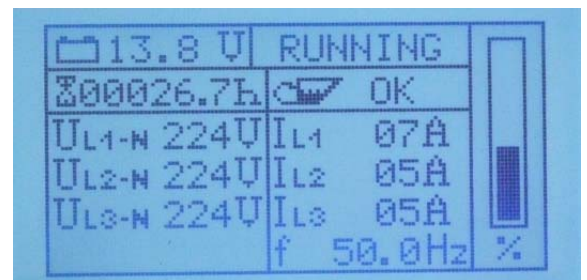

This screen provides the latest inverter phase voltages. You can access the inverter screen by actuating the cursor-up button while in operation mode.

Fig. 12.3.3.4-4: Inverter screen phase voltages

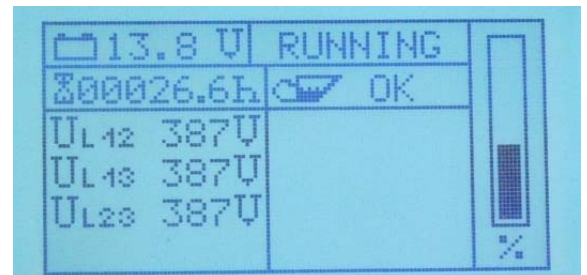

This screen provides the latest inverter output voltage of the single phases with the matching conductor current and the circuit board temperature. The inverter will be switched off at a circuit board temperature of 75 °C. You can access the inverter screen by actuating the cursor-up button while in operation mode.

Fig. 12.3.3.4-5: Phase voltage L1

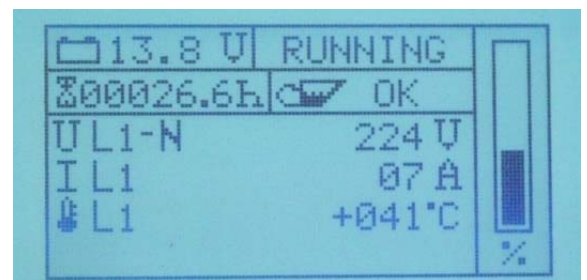

This screen provides the latest inverter output voltage of the single phases with the matching conductor current and the circuit board temperature. The inverter will be switched off at a circuit board temperature of 75 °C. You can access the inverter screen by actuating the cursor-up button while in operation mode.

Fig. 12.3.3.4-6: Phase voltage L2

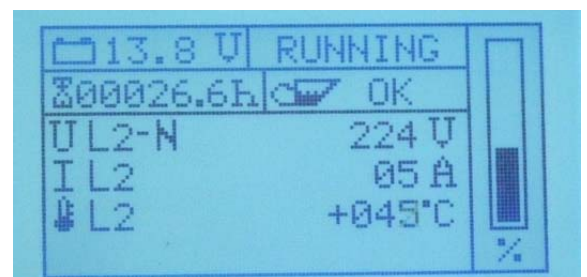

This screen provides the latest inverter output voltage of the single phases with the matching conductor current and the circuit board temperature. The inverter will be switched off at a circuit board temperature of 75 °C. You can access the inverter screen by actuating the cursor-up button while in operation mode.

Fig. 12.3.3.4-7: Phase voltage L3

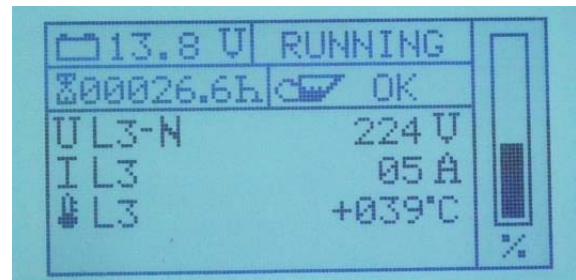

12.3.3.5 Panda i-Generator with electro-magnet Clutch (optional)

During the activation of the electro-magnetic clutch, the icontrol raise the generator speed to maximum.

After the clutch is released, the generator speed will drop to normal.

Attention!:



12.3.3.6 Stop mode

By activating the Start/Stop button in operation mode, i.e., while the generator is running, you will stop the generator. After stopping the generator, the system will return to stand-by mode. The display status field reads "STOPPING".

If the icon control system detect a high cylinder head temperature (for example after a long time running with high load) the icon control start a stopping delay timer. The Display shows „Cooldown“ and a countdown.

During this timer the icon control system will shut of the PMGi and run the engine at idle speed. During the delay time an automatic start request will be ignored.

After the delay time, the generator will be stopped automatically.

You can interrupt the delay time by pressing the start/stop button. (Not recommend by Fischer Panda. The Engine may overheat)

Fig. 12.3.3.6-1: Delay time

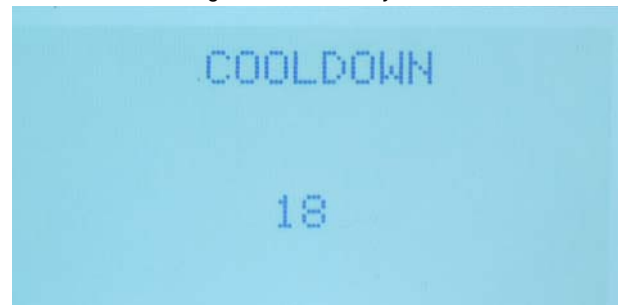

Never use an emergency stop switch for a regular stop of the generator.

The engine may overheat and can be damaged/destroyed

If the generator is manually started up and stopped while in automatic start-up mode, it will switch to stand-by mode for safety reasons.

If necessary, the autostart mode must be reactivated.

Attention:



Note: Manual start in autostart mode



12.3.3.7 Autostart mode

The Panda iControl2 panel is equipped with an autostart function. A jumper between pin 6 (UBAT) and pin 7 (USTART1) of the Phoenix jack of the control panel starts up the generator with a delay of 5 seconds when the autostart function is active. Removing the jumper will stop the generator - also with a delay of 5 seconds.

To activate the autostart function, you must first check the "Autostart" flag in the set-up menu. To activate the autostart function, read Siehe "Activating/deactivating the autostart function ("Autostart")" auf Seite 153.

The display status field reading "AUTOSTART" indicates that the autostart function is active, or, if it reads "STANDBY", this means that the autostart function was deactivated.

Fig. 12.3.3.7-1: Default display screen in autostart mode

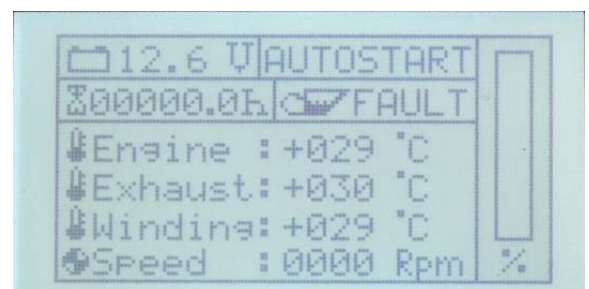

The autostart function will remain active even after the controller is switched off and on again with the On/Off button. To deactivate the autostart function, the flag in the EEPROM must be reset with "Disable". Siehe "Activating/deactivating the autostart function ("Autostart")" auf Seite 153.

If the generator is manually started up and stopped while in automatic start-up mode, it will switch to stand-by mode for safety reasons.

If necessary, the autostart mode must be reactivated.

Warning!: Automatic start-up



Note: Manual start in autostart mode



12.4 Other operating functions

12.4.1 Set-up menu

In the set-up menu, a series of parameters can be modified directly using the control panel. To access the set-up menu, you have to actuate the cursor-down button immediately after switching on the controller with the On/Off button and while the start screen with panda bear is still being displayed. This will open a menu with the following sub-items:

Fig. 12.4.1-1: Set-up menu

Menu item	Settings range for
backlight 1	Setting the brightness value for the standard backlighting to 0-9
backlight 2	Setting the brightness value for the dimmed backlighting to 0-9
Dimtime (dimming time)	Time until the display switches to dimmed mode, 0-225s, 0= function deactivated
Config	Password protected area for Fischer Panda associates and Fischer Panda service points
Network ID	Settings for the network ID of the panel
Save & Exit	Saving the values and exiting the set-up menu
Autostart	Activating and deactivating the automatic start-up function
Service	Resetting the "Operating hours to service" indication
Prime fuel	Activation of the fuel pump to prime the generator fuel system
Degree C/F	Switches the display between °C and °F

With the cursor-up and cursor-down buttons, you can navigate through the menu. The currently selected menu item is marked with two asterisks (*), e.g. "backlight 2*":

Set-up menu with item highlighted: *backlight 2*

Fig. 12.4-2: Set-up menu

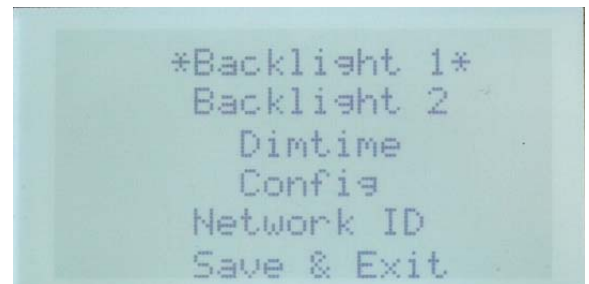

The Start/Stop button is used for confirming a selection in the set-up menu. If you confirm the row marked with the * with the Start/Stop button, you will access the selected sub-menu.

Note:



Set-up menu

Fig. 12.4-3: Set-up menu

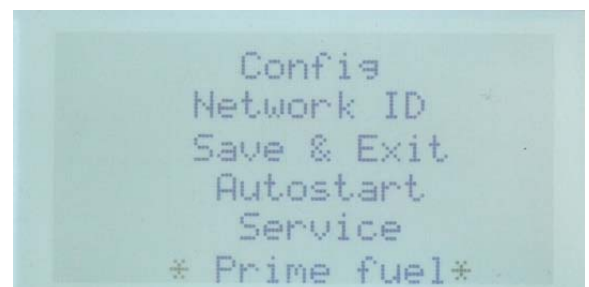

12.4.2 Setting the brightness of the backlight ("backlight" and "dimtime")

The brightness of the display backlight of the Panda iControl2 panel can be varied in ten increments (0-9). Also, the display can be dimmed with a timer if no button is actuated on the control panel for a parameter is able period. To adjust the default brightness and the dimmed brightness, the set-up menu offers the items "backlight 1" (default brightness) and "backlight 2" (dimmed brightness). These service menu screens are highlighted with the light bulb symbol:



The period after which the backlight is to switch to the dimmed level can be specified with the menu item "dimtime". In this screen, you can enter the time in seconds, values between 0s and 255s are possible.

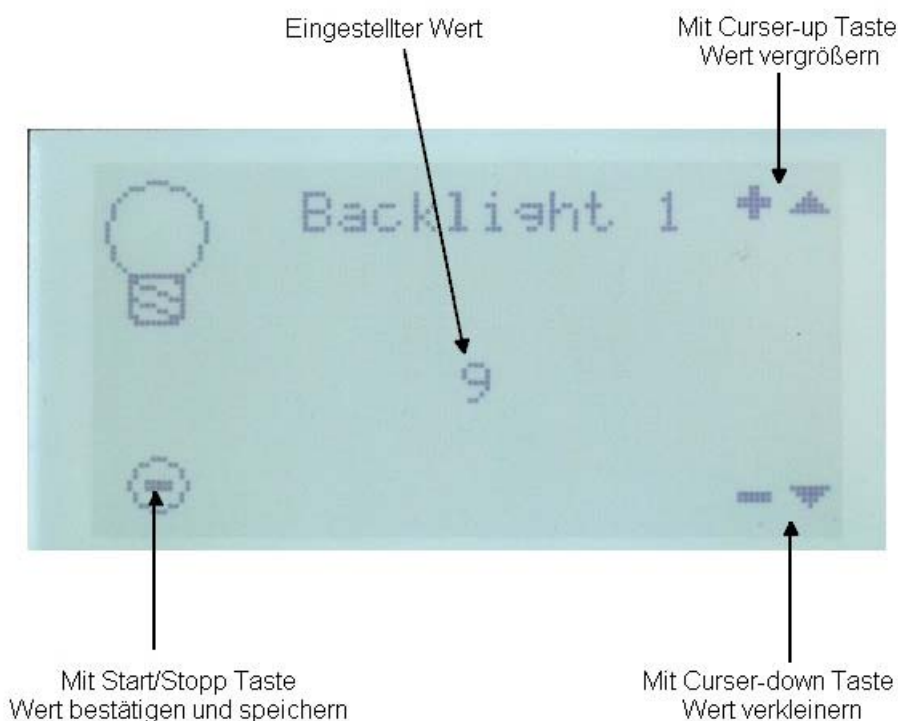

In the sub-menus, set the desired values with the cursor buttons, and then confirm your settings with the Start/Stop button. Note:



After setting all parameters, you can exit the set-up menu with the menu item "Save & Exit". In doing so, all settings entered in the sub-menus backlight 1, backlight 2, dimtime, and Network ID are saved to the EEPROM. Then, the goodbye screen appears for 3 seconds, and the controller is switched off.

At the next start of the controller, the changes will take effect.

12.4.3 The configuration menu ("config")

Settings in this area must only be entered by Fischer Panda associates and Fischer Panda service points.

STOP!



The "config" sub-menu is a password protected area in which the generator type can be selected, and generator parameters in the EEPROM can be modified.

12.4.4 The network ID

Settings in this area must only be entered by Fischer Panda associates and Fischer Panda service points.

STOP! Network ID must not be modified



Changing the network ID can result in malfunction.

12.4.5 Saving settings and exiting the set-up menu ("Save & Exit")

After setting all parameters, you can exit the set-up menu with the menu item "Save & Exit".

In doing so, all settings entered in the sub-menus backlight 1, backlight 2, dimtime, and Network ID are saved to the EEPROM.

Fig. 12.4.5-1: Saving the values to the EEPROM

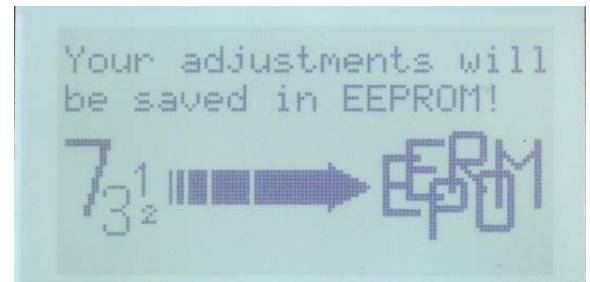

Then, the goodbye screen appears for 3 seconds, and the controller is switched off. At the next start of the controller, the changes will take effect.

12.4.6 Activating/deactivating the autostart function ("Autostart")

DANGER TO LIFE! - Improper operation can result in health impairment and death.

WARNING: Automatic start-up



While the automatic start-up function is active, the generator can start up automatically. Before activating it, ensure that the generator capsule is closed and that the corresponding warning signs are affixed to the generator.

To activate the autostart function, select the item "Autostart" in the set-up menu using the cursor buttons and confirm the selection with the Start/Stop button.

Fig. 12.4.6-1: Set-up menu

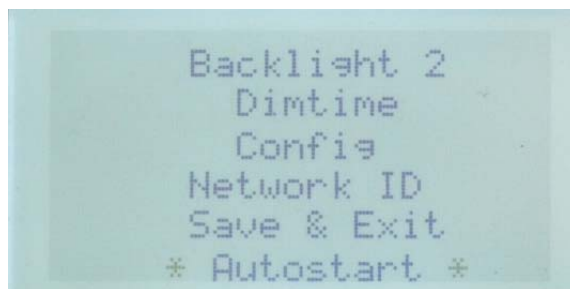

In the "Autostart" sub-menu, you can select between the options "Enable" and "Disable" using the cursor buttons:

Fig. 12.4.6-2: "Autostart" sub-menu



To activate the autostart function, select "Enable" and again confirm your selection with the Start/Stop button.

To deactivate the function, use the menu item "Disable".

The Panda iControl will then confirm your input:

Fig. 12.4.6-3: Message "Autostart enabled" after confirming the selection

Message "Autostart enabled" after confirming the selection

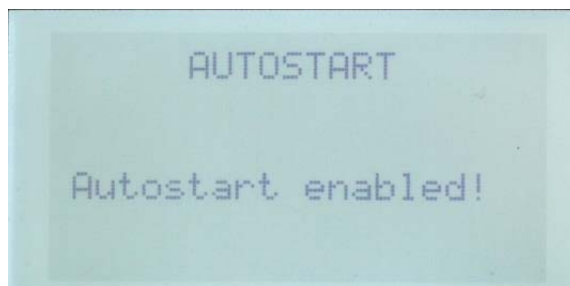

Message "Autostart disabled" after confirming the selection

Fig. 12.4.6-4: Message "Autostart disabled" after confirming the selection

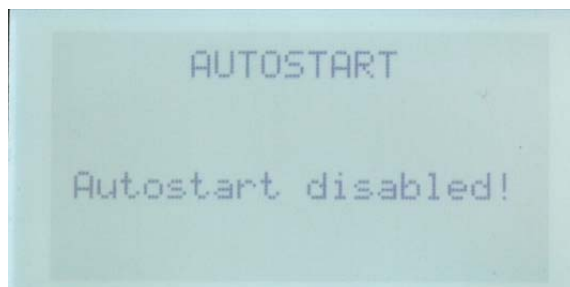

The activation/deactivation of the autostart function is then saved to the EEPROM of the control panel.

Fig. 12.4.6-5: Selection is saved to the EEPROM

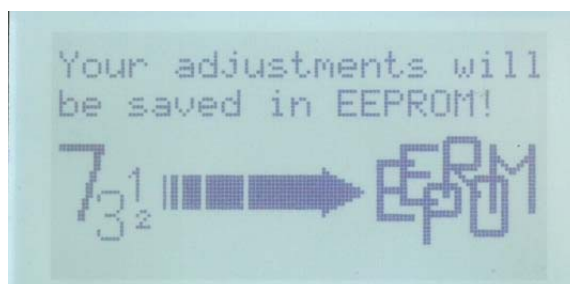

Then, the controller is shut down.

Fig. 12.4.6-6: Goodbye screen prior to shutting down



After switching the controller back on, the display status field reading "AUTOSTART" indicates that the autostart function is active, or, if it reads "STANDBY", this means that the autostart function was deactivated:

Fig. 12.4.6-7: Default display screen in autostart mode



The autostart function will remain active even after the controller is switched off and on again with the On/Off button. To deactivate the autostart function, the flag in the EEPROM must be reset with "Disable" as described above.

Warning!: Automatic start-up



The autostart function of the Panda iControl2 is now ready. While the autostart function is active, you can manually start and stop the generator with the Start/Stop button, as well.

If the generator is manually started up and stopped while in automatic start mode, it will switch to stand-by mode for safety reasons.

Note: Manual start in autostart mode



If necessary, the autostart mode must be reactivated.

12.4.7 Resetting the service interval ("Service")

As the indication of operating hours remaining until the next service interval can be reset at any time, it serves only as an orientation guide. The service intervals shall be implemented using the actual operating hours and shall be properly documented in the service log of the generator.

Note



With the dynamic operation hours the service interval can be raised up to 30% (200h max.). Make sure that the dynamic operation hours are not reset accidentally between the service interval.

Note:



In the set-up menu, select the menu item "Service" and confirm as usual, using the Start/Stop button. This will open the screen with the service information discussed above, supplemented with the instruction to actuate the Start/Stop button to reset the service interval.

Resetting the time until the next service

By actuating the Start/Stop button again, you can reset the service interval to the original interval. The service interval for each generator type is stored in the software.

The controller is switched off after resetting the service interval. After restart, the new value will be displayed in the service screen.

Fig. 12.4.7-1: Resetting the time until the next service



12.4.8 Priming the fuel system ("Prime Fuel")

To prime the fuel system, the Panda iControl2 offers the option of separately activating the fuel pump. In the set-up menu, select the menu item "Prime fuel" and confirm your selection using the Start/Stop button.

Actuating the Start/Stop button again will switch on the fuel pump for a duration of max. 30 seconds. After that, the fuel pump will shut off automatically.

Naturally, you can also switch off the fuel pump manually.

For this purpose, confirm the menu item "Prime fuel" again, and switch off the fuel pump using the Start/Stop button.

Fig. 12.4.8-1: Set-up menu

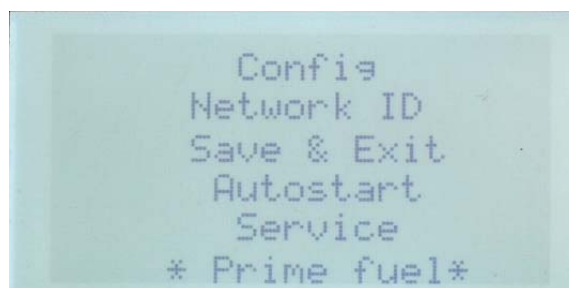

12.4.9 Selecting and saving a unit for the temperature value output

With the Panda iControl2 panel, you can output the temperature values on the display in degrees Celsius [°C] or in degrees Fahrenheit [°F]. The unit can be switched with the control panel. In the set-up menu, select the menu item "Degree C/F" and confirm your selection using the Start/Stop button.

Using the cursor buttons, select 0' for outputting all temperatures in degrees Celsius [°C] or 1' for outputting them in degrees Fahrenheit [°F]. To confirm your selection, actuate the Start/Stop button.

You can enter additional settings in the set-up menu, or you can exit the set-up menu with "Save & Exit". Your selections will then be saved to the EEPROM of the Panda iControl2 panel.

After restarting the system with the On/Off button, your settings will take effect, and all temperatures will be output with the selected unit.

Settings options:

0 Output of all temperatures in degrees Celsius [°C]

1 Output of all temperatures in degrees Fahrenheit [°F]

12.5 iControl2-Emergency-Stop

The iControl2 is prepared for the connection of an emergency stop. The socket for the emergency stop is in the cable harness integrated and bridged (1X1, optional emergency off). The bridge must be removed and the emergency stop connected.

After the emergency stop is initiated, the servo drives to zero position, all out of the iControl controller are switched off and the power supply to the inverter is switched off.

The Panel shows „Emergency Stop“.

Damit wird auch die Spannungsversorgung für den Inverter ausgeschaltet.

Das Panel zeigt nach der Betätigung „EMERGENCY STOP!“. The message disappear as soon as the emergency switch is released.

Fig. 12.5-1: Not Stop bridge in the cable harness



Fig. 12.5-2: Panel shows Emergency Stop



Leere Seite / Intentionally blank

13. Installation

All connecting wires and instructions for installation are designed and adequate for „standard“ installation situations.

As Fischer Panda does not know the specific installation and operating situation (e.g. special vehicle shapes, high travel speeds, and special application conditions, etc.), this installation specification can only serve as a guideline and example. The installation must be adjusted and implemented by a competent specialist based on the local conditions and requirements.

If damage occurs due to wrong installation without adjusting for specific conditions, it is not covered by the warranty.

WARNING: Properly dimension your system.



13.1 Personnel

The installation described herein must be implemented by specially trained technical personnel or by authorised workshops (Fischer Panda Service Points), only.

13.1.1 Hazard warnings for installation

Ensure compliance with the general safety instructions at the beginning of this manual.

Note:



DANGER TO LIFE! - Improper operation can result in health impairment and death.

Warning!: Automatic start-up



The battery must always be disconnected (first the negative terminal, then the positive terminal) if work on the generator or electrical system is to be carried out, so that the generator cannot be unintentionally started.

Improper installation can cause severe injury and/or substantial property damage. Therefore:

WARNING: Risk of injury!



- Always turn off motor to perform installation work.
- Ensure adequate space for assembly prior to starting work.
- Ensure order and cleanliness at the work place! Parts and tools loosely stacked or lying on the floor represent accident hazards.
- Use only standard tools and special tools for installation work. Incorrect or damaged tooling can result in injury.

DANGER TO LIFE! - Improper operation can result in health impairment and death.

WARNING: Electric voltage



Electric voltages of more than 60 V are potentially lethal in any situation. The rules of the respective regional authority must be adhered to during installation. For safety reasons,

only an electrician may carry out the installation of the electrical connections of the generator.

Generator and cooling water may be hot during and after operation. Burn/scalding hazard!

During operation, overpressure may build up in the cooling system.

For installation work, personal protective equipment is compulsory. This includes:

- Tightly fitting protective clothing
- Safety shoes
- Safety gloves
- Hearing protection
- Safety goggles if applicable

All loads must be disconnected prior to working on the generator to avoid damage to the devices.

WARNING: Hot surface/material



MANDATORY INSTRUCTION: Protective equipment required



WARNING: Switch off all loads.



13.2 Disposal of the components

Electronics components are hazardous to the environment and contain rare raw materials.

Collect and properly dispose of components that are no longer needed!

MANDATORY INSTRUCTION: Protect the environment.



The iControl2 board is typically pre-installed on the generator, and the corresponding connecting lines for connecting it to the iControl2 panel and the PMGi are prepared. See generator manual.

13.2.1 Panda iControl2 panel with installation housing

Fig. 13.2.1-1: Panda iControl2 panel with panel connecting cable and closed housing



13.2.2 Terminal assignments on the Panda iControl2 panel

The Panda iControl2 panel is connected via a 7-pin Phoenix jack.

Fig. 13.2.2-1: Terminal assignment on the Panda iControl2 panel

Terminal	Terminal description	Cable colour	Function
1	UBUS	white (WH)	Bus supply voltage
2	GND	brown + shielding (BN)	Fischer Panda bus ground, ground connection between Panda iController and Panda iControl panel
3	REIZ	green (GN)	Exciter wire, is switched to ground if the controller is to switch on
4	DATA-A	pink (PK)	Fischer Panda bus data line A
5	DATA-B	Grey (GY)	Fischer Panda bus data line B
6	UBATT	--	Autostart ^a
7	USTART/STOPP	--	Autostart ^b

a. A jumper between terminal 6 and 7 closes the autostart contact.

b. A jumper between terminal 6 and 7 closes the autostart contact.

Use only original Fischer Panda connecting cables.

Note:



13.3 Dimensions

Fig. 13.3-1: Housing of the Panda iControl2 panel

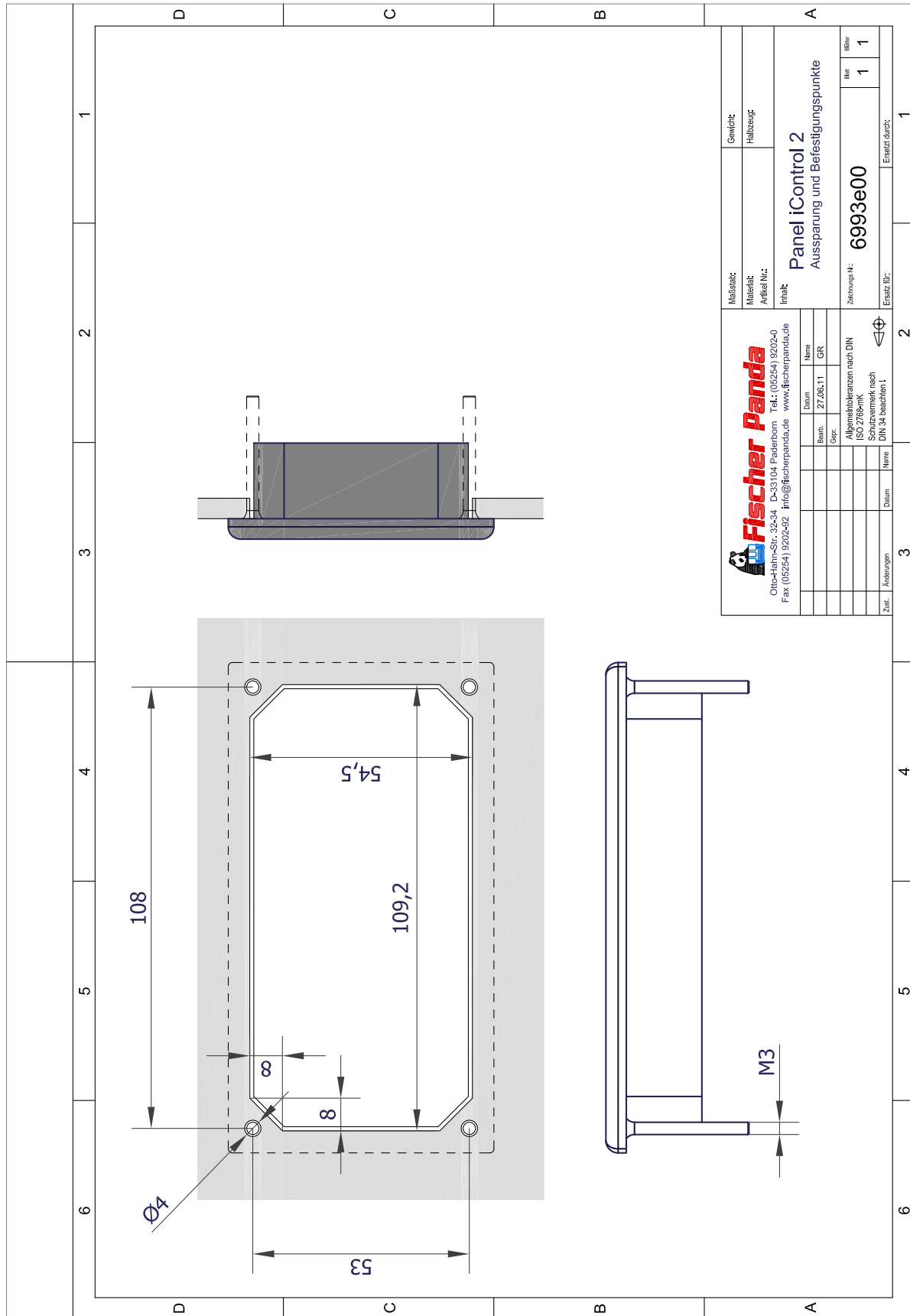

Due to the terminals being exposed, the protection class IP 04 applies to the iControl2 panel. Please note!

If properly installed with a seal (e.g. Sikaflex), up to IP66 can be achieved.



13.4 Wiring of the Panda iControl2 controller

Fig. 13.4-1: Wiring of the Panda iControl2 controller

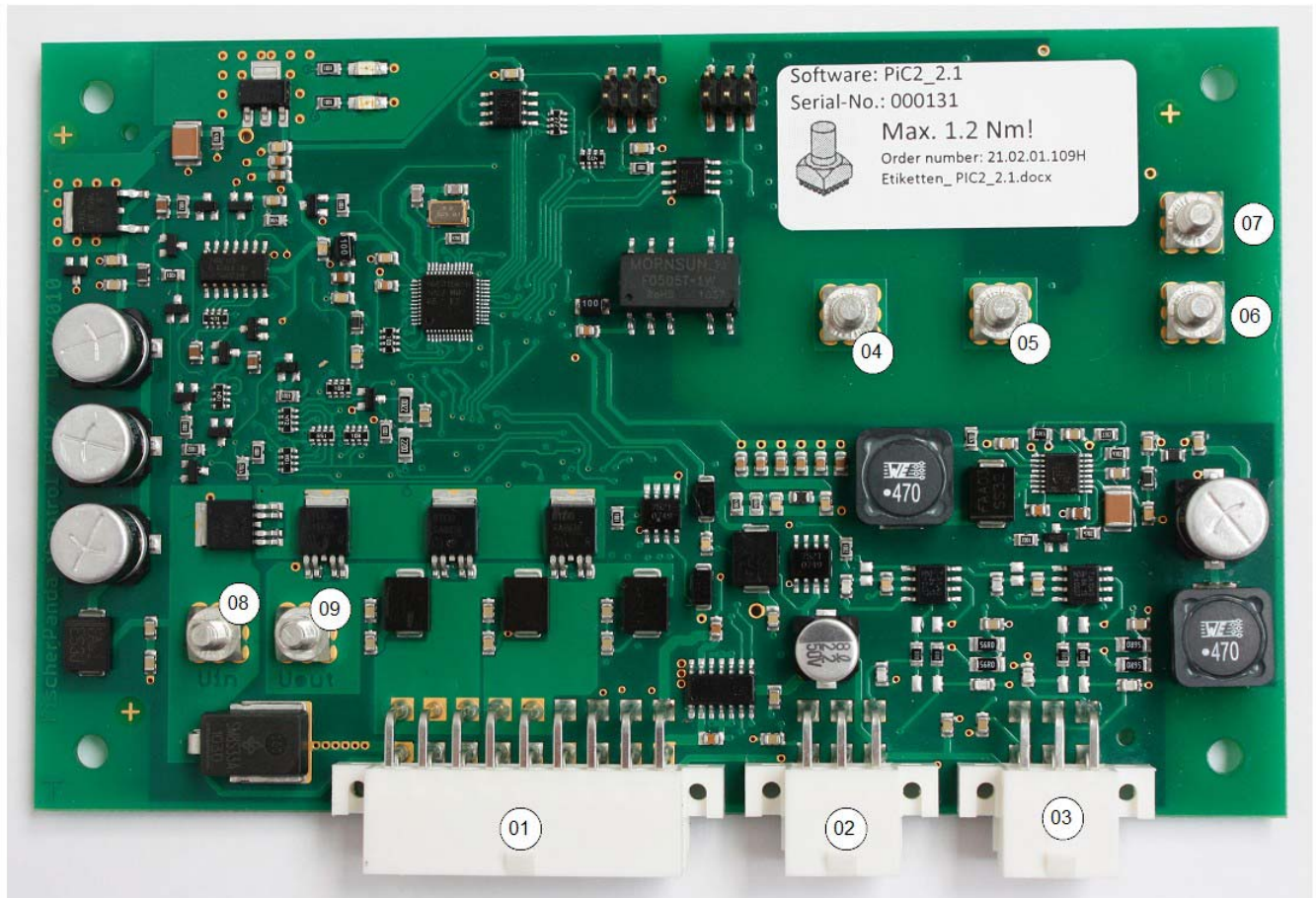

The Panda iControl2 controller is connected to the wire harness with the 18-pin jack. The centre 6-pin jack is designed for the Fischer Panda standard bus. The Panda iControl2 panel is connected to this jack. The Fischer Panda CAN bus is connected to the 6-pin jack at the bottom right of the circuit board. The configuration of the connectors is given in the subsequent tables. Siehe "Terminal assignments on the Panda iControl2 controller" auf Seite 164.

1. Connecting jack for wire harness, 18-pin
2. Connecting jack, 6-pin, Fischer Panda standard bus
3. Connecting jack, 6-pin, Fischer Panda CAN bus for optional use
4. Connecting bolt for phase L3 (load output to inverter) and input from winding L3
5. Connecting bolt for phase L2 (load output to inverter) and input from winding L2
6. Connecting bolt for winding L1
7. Connecting bolt for phase L1 (load output to inverter)
8. Input for supply voltage +12V
9. Pre-heating output

13.4.1 Terminal assignments on the Panda iControl2 controller

13.4.1.1 Terminal assignment of 18-pin connector

Fig. 13.4.1.1-1: Terminal assignment of 18-pin connector

Terminal	IN / OUT	Function
1	--	Actuator (optional)
2	I	Cylinder head temperature
3	IN	Exhaust manifold temperature
4	IN	Winding temperature
5	IN	Reserve temperature
6	IN	Oil pressure
7	IN	Emergency stop
8	--	GND, ground for all temperature sensors
9	--	GND
10	--	Actuator (optional)
11	--	+5V servo motor (red wire)
12	OUT	PWM servo motor (yellow wire)
13	OUT	Booster (optional, depending on generator type)
14	OUT	Fuel pump
15	OUT	Fuel pump
16	OUT	Electric starter
17	OUT	Electric starter
18	OUT	Electric starter

13.4.1.2 Fischer Panda standard bus

Fig. 13.4.1.2-1: Fischer Panda standard bus terminal assignment

Terminal	Terminal description	Function
1	UBUS	Bus supply voltage
2	GND	Fischer Panda bus ground, ground connection between Panda iControl2 controller and Panda iControl2 panel
3	REIZ	Exciter line, is switched to ground by the panel if the controller is to switch on
4	DATA+	Fischer Panda bus data line A
5	DATA-	Fischer Panda bus data line B
6	UBAT	Battery voltage

13.4.1.3 Fischer Panda CAN bus

Fig. 13.4.1.3-1: Fischer Panda CAN bus terminal assignment

Terminal	Terminal description	Function
1	UBUS	Bus supply voltage
2	GND	Fischer Panda bus ground, ground connection between iControl2 controller and Panda iControl2 panel
3	REIZ	Exciter line, is switched to ground by the panel if the controller is to switch on
4	CAN-L	CAN-Low
5	CAN-H	CAN-High
6	UBAT	Battery voltage

13.5 Master and Slave Panels

With the iControl2 it is possible to have up to four remote control panels at one iGenerator. (One Master + three Slave)

The standard iControl panel has the Art. No. 21.02.02.131P. This Panel has integrated termination resistors and is the Master Panel.

The iControl2 Slave Panel has the Art. No. 21.02.02.132P. It is marked with a sticker „Slave Panel“ at the back side.

In a iControl system with Master and Slave panels, The Master must be the last one in the row, so that the termination resistor is at the end of the FP-BUS.

The Slave Panel can not be used alone. The Slave Panels must be connected between the iControl controller (at the iGenerator) and the Master Panel.

The Master Slave configuration can be used at iGenerators with software 2.3 at Controller and Panel.

All Panels (Master and Slave) has the Address „1“ as standard. The Address can be changed in the menu. Possible are 1, 2, 3 and 4. Each Panel must have a unique address.

To use the automatic start option, the connection of the automatic start must be at the panel with the address „1“. Activation or deactivation can be done at every panel.

Fig. 13.5-1: Master Slave configuration

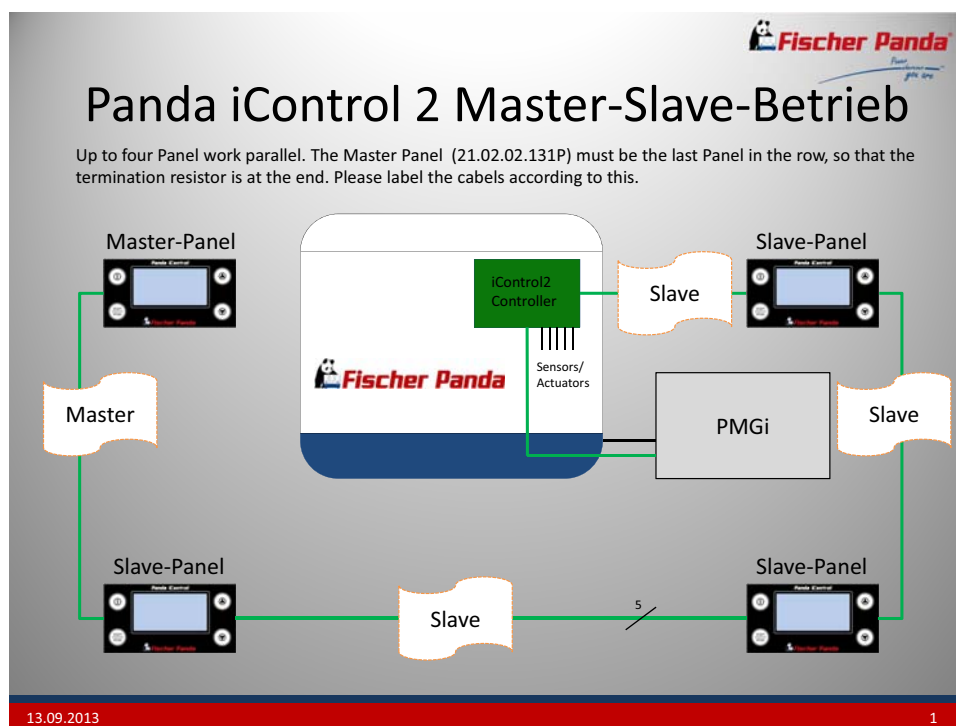

13.6 Start-up

After completing the installation, the system must be started up.

For this purpose, the start-up log for the generator is processed and filled in by the specialist installing the equipment. The completed log shall be handed over to the operating company.

The operating company shall be instructed in the operation, maintenance, and hazards of the generator. This applies to both the maintenance steps and hazards described in the manual and to additional steps and hazards that result from the specific installation conditions and the connected components.

The original start-up log of the generator must be sent to Fischer Panda to obtain the full warranty. Make sure that you retain a copy for your records.

Note:



The corresponding forms are included in the generator manual.

14. Maintenance

14.1 Maintenance of the iControl2 controller

The iControl2 controller is maintenance-free. The fuses of the controller are self-healing.

14.1.1 Cleaning the iControl2 controller

The housing shall be cleaned within the scope of the overall generator cleaning. The housing can be wiped off with a soft, lightly dampened cloth. In doing so, it must be ensured that no moisture enters the jacks and the housing.

14.2 Maintenance of the iControl2 remote control panel

The iControl2 remote control panel is maintenance-free.

14.2.1 Cleaning the iControl2 controller

The display can be cleaned with a soft cloth dampened lightly with soapy water. Harsh cleaning agents are not suitable and can cause the display film to turn dull.

Leere Seite / Intentionally blank

15. Warnings and error messages

To enable the safe operation of the generator, the Panda iControl2 controller is programmed with a series of warnings and error messages that influence the generator operation.

15.1 Warnings

Warnings are issued when the variable being monitored, e.g. temperature, reaches a defined warning threshold. The warnings are issued on the Panda iControl2 panel display via the cyclical display of the word „HIGH“ or „LOW“, alternating with the measured value, e.g. the temperature. Warnings do not become active until the time between reaching the threshold value and the defined delay has expired.

Warnings do not result in the generator or the controller being switched off. Note:



15.1.1 Examples of warnings on the display:

Warning: „Battery power too low“

Fig. 15.1.1-1: Warning: „Battery power too low“



Warning: „Winding temperature too high“

Fig. 15.1.1-2: Warning: „Winding temperature too high“



15.1.2 Warning messages

All warning messages defined for the Panda iControl 2 and the corresponding display output are compiled in the subsequent table.

Fig. 15.1.2-1: Warning messages

Warning message on the display	Meaning of warning message
„HIGH“ flashes, alternating with the temperature value of the cylinder head	Cylinder head temperature is too high, the warning threshold was reached
„HIGH“ flashes, alternating with the temperature value of the winding	Winding temperature is too high, the warning threshold was reached
„HIGH“ flashes, alternating with the temperature value of the exhaust manifold	Exhaust manifold temperature is too high, the warning threshold was reached
„LOW“ flashes, alternating with the voltage value of the starter battery	Starter battery voltage is too low, the warning threshold was reached

15.2 Faults

Error messages are issued when the monitored variable, e.g. a temperature, reaches the defined fault threshold.

With the temperature sensors, a loose connection or a broken cable will result in a fault, as well, and cause the generator to shut down.

An error message is typically preceded by a warning, as the warning threshold is reached before the fault threshold. Error messages are output on the Panda iControl2 panel display in the form of the error text shown on a cleared display page. Faults do not become active until the time between reaching the fault threshold and the defined delay has expired.

Faults result in the generator shutting down. If a fault occurs due to the battery voltage being too low, the controller is completely shut down to prevent the battery from discharging too much.

Examples of an error message on the display:

Fault: „Exhaust manifold temperature out of range“

(broken cable)

Fig. 15.2-1: Fault: „Cylinder head temperature out of range“



Fault: „Winding“, winding temperature too high

Fig. 15.2-2: Fault: „STARTING FAILS“, start-up process was not successful

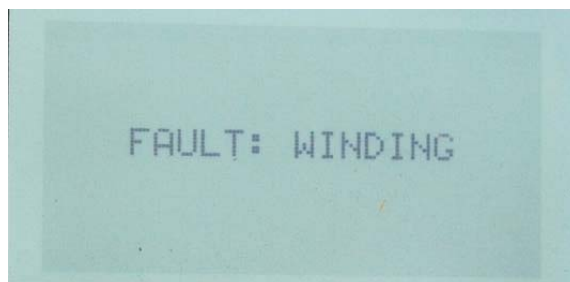

15.2.1 Error messages

All error messages defined for the Panda iControl 2 and the corresponding display texts are compiled in the subsequent table.

Fig. 15.2.1-1: Error messages

Error message on the display	Meaning of error message
FAULT: CYL.HEAD	Cylinder head temperature too high
FAULT: WINDING	Winding temperature too high
FAULT: EXHAUST	Exhaust manifold temperature too high
NO CONNECTION BUS ERROR	Communication error on Fischer Panda bus
STARTING FAILS	Generator start has failed
PROBLEM WITH FUEL SUPPLY!	Fuel supply not suitable
FAULT: OILPRESS	Oil pressure error
BATTERY LOW	Battery power too low
Inverter overtemp	Inverter temperature too high
Inverter overload	Generator was overloaded.
INIT FAILED!	Parameters were not correctly adopted into the EEPROM when the generator type was initialised. Generator type must be reset.
„OUT“ is output instead of a temperature	„Out of range“ - broken cable on corresponding temperature sensor

Error messages can be acknowledged with the Start/Stop button, The controller will then return to stand-by mode.

15.2.2 Warning and fault thresholds

The threshold values resulting in triggering warnings and faults depend on the generator type and are compiled in table 2-3.

Fig. 15.2.2-1: Warning and fault thresholds for different generator types

Generator type	Warning/fault	Warning threshold	Fault threshold
5000i marine	Cylinder head temperature	85 °C	95 °C
	Delay	5 s	5 s
	Winding temperature	130 °C	135 °C
	Delay	5 s	5 s
	Exhaust manifold temperature	70 °C	75 °C
	Delay	1 s	1 s
5000i vehicle	Cylinder head temperature	90 °C	95 °C
	Delay	5 s	5 s
	Winding temperature	130 °C	135 °C
	Delay	5 s	5 s
	Exhaust manifold temperature	100 °C	105 °C
	Delay	1 s	1 s
P8000i / P10000i marine	Cylinder head temperature	90 °C	95 °C
	Delay	5 s	5 s
	Winding temperature	130 °C	135 °C
	Delay	5 s	5 s
	Exhaust manifold temperature	70 °C	75 °C
	Delay	1 s	1 s
P8000i / P10000i vehicle	Cylinder head temperature	90 °C	95 °C
	Delay	5 s	5 s
	Winding temperature	130 °C	135 °C
	Delay	5 s	5 s
	Exhaust manifold temperature	100 °C	105 °C
	Delay	1 s	1 s

Generator type	Warning/fault	Warning threshold	Fault threshold
P8-P50 marine	Cylinder head temperature Delay	90 °C 5 s	95 °C 5 s
	Winding temperature Delay	130 °C 5 s	135 °C 5 s
	Exhaust manifold temperature Delay	70 °C 1 s	75 °C 1 s
P8-P50 vehicle	Cylinder head temperature Delay	95 °C 5 s	100 °C 5 s
	Winding temperature Delay	160 °C 5 s	165 °C 5 s
	Exhaust manifold temperature Delay	100 °C 1 s	105 °C 1 s
P15000i marine	Cylinder head temperature Delay	90 °C 5 s	95 °C 5 s
	Winding temperature Delay	130 °C 5 s	135 °C 5 s
	Exhaust manifold temperature Delay	70 °C 2 s	75 °C 2 s
P15000i vehicle	Cylinder head temperature Delay	90 °C 5 s	95 °C 5 s
	Winding temperature Delay	130 °C 5 s	135 °C 5 s
	Exhaust manifold temperature Delay	95 °C 2 s	100 °C 2 s
All generator types	Starter battery voltage low Delay	11.8 V 30 s	10.8 V 30 s
	Starter battery voltage high	15.0 V 5 s	-- --

15.2.3 Bus errors

If the communication connection is lost on the Fischer Panda bus, an error is output on the display after a period of 10 seconds:

This error will occur if at least one of the two data lines of the Fischer Panda bus is disconnected. Once the connection is restored, the error message can be acknowledged with the Start/Stop button.

Fig. 15.2.3-1: Error: „NO CONNECTION“, error in the communication (Fischer Panda bus)

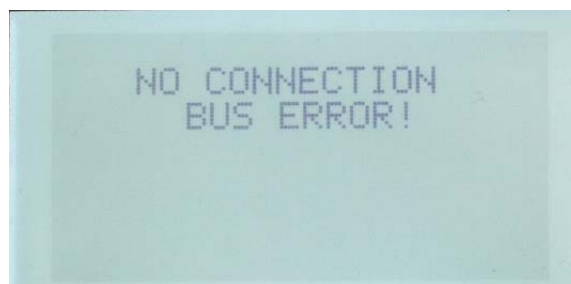

If the communication connection is lost, the generator shall be secured (open battery disconnect switches), and all plug-in connections and cables shall be checked for firm seating or damage.

15.3 The error memory of the iControl 2 Panel

From Software version PiC2_2.9 (control board) and PiP2_2.9 (control panel) the Panda iControl2 has got an error memory which shows the last six errors in the plain text.

15.3.1 How to get to the error memory of the iControl2 Panel?

The error memory is easily accessible via the setup menu of the control panel which is open to every user.

The setup menu can be accessed as usual:

- To access the setup menu, please press the key "Cursor Down" directly after switching on the control while the panda bear is displayed.
- Now you can see the setup menu and its menu items.
- You can navigate through the menu via the keys
- „Cursor-Up“ und „Cursor-Down“.
- The selected menu item is marked by two *symbols.
- The start/stop key is used for validation in the setup menu. If you select and validate the row marked by the * by actuating the start/stop key, you will access the selected sub-menu.
- To display the error memory please select the menu item **Error mem.**

15.3.2 How are stored errors displayed?

The errors are displayed in the plain text. The error is preceded by the operating hour when the error occurred. The fault having the highest operating hour will be displayed in the first row. Older error entries are displayed in the rows below in descending order of the operation hour. If the memory contains already six errors, the oldest entry is deleted.

Example for displaying an error entry: **3045.2h COMMUNICATION**

This means: In operating hour 3045.2 an error in the bus communication has occurred.

15.3.3 How do I exit the error memory after having read the entries?

You can return to the standby page via the start-stop-key.

15.3.4 Can I delete the error memory?

No, it is not possible to delete the error memory.

15.3.5 Where are the errors stored?

In the EEPROM of the panel or in the storage of the control board?

The errors are stored in the EEPROM of the control board. The control panel only displays the errors which are stored there. If, for service reasons, the control panel has to be exchanged, the entries remain in the error memory.

15.3.6 In which language are the stored errors displayed?

The stored errors are displayed in the language which is set in the control panel. This can be English or German depending on your settings.

15.3.7 Is it possible to upgrade an old iGenerator model by the error memory?

Yes, if the software of the control board and the panel is updated, it is possible to upgrade an existing system by this function.

Fig. 15.3.7-1: Image: Display of the stored errors on the control panel



16. Annex

16.1 Technical data

16.1.1 Technical data for iControl2 control unit

Fig. 16.1.1-1: Technical data for iControl 2 control unit

	iControl 2 control unit
Supply voltage	12V-13.5V (12V automotive)
Current consumption, nominal	175 mA
Current consumption, stand-by	2.5 mA
Operating temperature	-20°C to +85°C
Storage temperature	-30°C*to +85°C
Current sensor Hall element	max. 20A
max. tightening torque for connecting bolts	1.2 Nm

16.1.2 Technical data for iControl2 remote control panel

Fig. 16.1.2-1: Technical data for iControl2 remote control panel

	iControl 2 control unit
Supply voltage	12V-24V (12V or 24V automotive)
Current consumption, off	0 mA
Current consumption, stand-by - backlight brightness 9	45 mA
Current consumption, stand-by - backlight brightness 4	33 mA
Current consumption, stand-by - backlight brightness 0	25 mA
Operating temperature	-20°C to +70°C
Storage temperature	-30°C*to +80°C

Leere Seite / Intentionally blank