



Totally Focused. Totally Independent.

Technical Guide

EC046 4 A



The world's largest
independent producer of
alternators 1 – 5,000kVA

Standards

Alternators are designed and produced within an ISO 9001 environment. The entire series is manufactured according to, and complies with, the most common specifications such as CEI 2-3, IEC 34-1, EN 60034-1, VDE 0530, BS 4999-5000, NF 51.111, CAN/CSA-C22.2 No14-95-No100-95, NEMA MG 1-2011, ISO 8528-3. Other standards such as UL1446, UL 1004/4 and /B are available on request.

Windings and Performances

All windings are 2/3rds pitch to eliminate triplen harmonics within the voltage waveform and to avoid excessive neutral currents in certain parallel operating conditions. A fully interconnected aluminium or copper damper cage is supplied on the rotor of all models (excluding the ECP3 series).

- ▶ 12 wire reconnectable:
 - 50Hz – 380V to 440V and 220/110V to 240/120V (de-rates may apply at certain voltages)
 - 60Hz – 380V to 480V and 220/110V to 240/120V (de-rates may apply at certain voltages)
- ▶ 6 wire reconnectable:
 - 50Hz – 380V to 440V and 220V to 240V (de-rates may apply at certain voltages)
 - 60Hz – 380V to 480V and 220V to 240V (de-rates may apply at certain voltages)

Winding Configurations	Standard		Special (dedicated)			
	12 wire Reconnectable	6 wire Reconnectable	380V and 600V 60Hz	690V 50/60Hz	220-240V 1ph 50Hz	220-240V 1ph 60Hz
ECP3 to ECO38	Std	Option	Option	Option	Option	Option
ECO40 to ECO46	Std	Option	Option	Option	Option (to ECO40)	Option (to ECO40)
Insulation materials	Class H	Class H	Class H	Class H	Class H	Class H
High efficiency	Std	Std	Std	Std	Std	Std
High motor starting	>300%	>300%	>300%	>300%	>300%	>300%
THD (Total Harmonic Distortion)	Typically <3.5% full load L-L	Typically <3.0% full load L-L	Typically <3.5% full load L-L	Typically <3.5% full load L-L	Typically <4.5% full load L-N	Typically <4.5% full load L-N
Interference suppression	VDE 0875 G/N/K, EN61000-6-3, EN61000-6-2, others available on request					

Winding Protection

There are various degrees of protection for the windings following the standard impregnation process, as can be seen here. The TOTAL+ butadienic black flexible coating is recommended for arduous applications.

Winding Protection:	STANDARD	STANDARD+	GREY	GREY+	TOTAL+ (3% de-rate may apply on certain models)
ECP3	Std	Option	Option	Option	Option
ECP28, NPE32 and ECP32	-	Std	Option	Option	Option
ECP34 to ECO46	-	-	Std	Option	Option

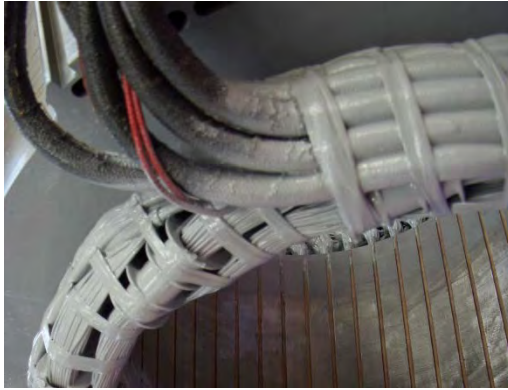

Grey treatment (marinization) on the left, TOTAL+ treatment shown on the right. The EG43 grey varnish, is an high temperature insulating enamel that forms a tough and flexible film, with excellent moisture and chemical protection. It is water and oil proof, and also protects windings from abrasion. It is applied spraying an over coating layer over the impregnated winding, or dipping the stator in a varnish barrel for superior treatments

The TOTAL+ is a protection system that makes Mecc Alte special. It is the ultimate winding treatment that offers truly superior performances when the environment is really harsh, or the application very demanding. It is a rubbery protection treatment, used to replace epoxies and silicones winding encapsulation. The TOTAL+ flexible black compound cures to a tough, resilient, glossy black thick coating that seals the copper against moisture and chemical attacks. Due to its encapsulation capability and flexibility, is also extremely resistant to the particle abrasion as it adsorbs the impacts. Moreover, the high flexibility leads to a long-trouble less life protection, as the compound follows elastically the thermal expansion cycles of the windings from the cold to the hot condition and vice versa without forming any cracks.

Protection for Environment

In addition to protection on the windings themselves, the alternators can have increased ingress protection. Standard levels are IP23 with further upgrades available to include inlet filters, IP43 and IP45: 7% de-rates apply on inlet filters and IP43 protection. 20-30% de-rates apply for IP45 depending on alternator model.

Additional air exit louvres (called IP23+) are optionably retrofittable in the overall ECP32 to ECO 46 range, in order to comply to the most strict marine regulations.



Construction

The robust mechanical structure withstands up to 5G in any direction and 9G vertically and its design permits easy access to the connections and components during routine maintenance check-ups. The mechanical design has used the most advanced FEM techniques. The materials used are: FEPI2 steel for the frame, C45 steel for the shaft and cast iron or aluminum pressure die cast for the end-brackets: fans are aluminum die casted either nylon fiber glass loaded, UL compliant materials. Rotors are dynamically balanced according grade 2.5 of ISO 1940-1.

Terminals and Terminal Box

Easy access to regulators is assured through a pull out drawer or a drop down panel to allow safer adjustment. Large terminal boxes allow easy access of power cables, in the ECO43 and ECO46 higher power ranges the terminal allow the convenient choice of power cable or busbar connection with versatility of entry and connection. Current transformers are available as an option on series ECO 40, 43 and 46 with single or dual output.

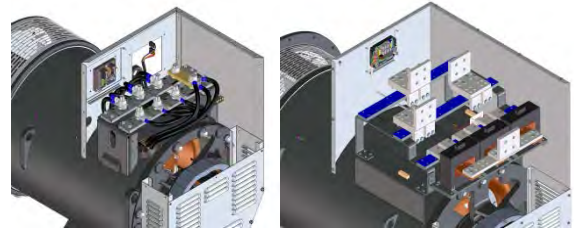

Excitation and Regulation Systems

All ECP/ECO series have MAUX auxiliary winding to power the digital regulator. Both DSR and the DER1 are available to connect to PC through the DxR2 USB interface and DxR TERMINAL software to interrogate/download alarms & settings for analysis or for cloning other regulators. DER2 has got an integrated USB connection and can be connected to the PC without any optional connection boards. More settings such as LAMS, digital RAM based synchronous external control and soft start are obtainable through the DxR connection. Simple analogue potentiometers are available for the more usual adjustments.

Excitation Systems	DSR	DER1	DER2
ECP3 to ECO38	Std	Option	Option
ECO40 to ECO46	-	Std	Option
Parallel Operation	√	√	√
Mains Parallel	√	√	√
3 Phase Sensing (rms)	-	√	√
Accuracy	+/-1%	+/-0.5%	+/-0.5%
Remote Voltage Control	√	√	√
Alarm Log	√	√	√
Analogue and Digital Configurable	√	√	√
LAMS (Load Acceptance V/f)	√	√	√
APO (Active Protection Output)	√	√	√
Soft Start	√	√	√
High dynamic response	-	-	√
USB connection without external boards	-	-	√

For a given motor start duty a smaller machine may be selected – also enhanced by low sub-transient reactance values for non-linear loads. The whole range from 6.5 to 3400kVA is capable of >300% sustained short circuit current for up to 20 seconds.

Optional PMG3

PMG3 can be retro fit or factory fit on ECO 40, 43 and 46 series. This smart MeccAlte design allows an easy fix kit, through a tapered cone coupling and a simple replacement of the rear air louvre. PMG3 is also available on ECO 38, when ordered from the factory.

The complete AVR range is fully compatible with both MAUX and PMG3 systems, this minimises spare part management and flexibility of stock as one AVR suits all applications. The PMG3 is delivering the same amount of kVA available with the MAUX.



Accessories

Additional optionals can be fit on our alternator series, such as PTC thermistors or PT100 both on windings and bearings, space heaters, high and low profile of terminal boxes (on most series), air filter clogging sensors, rotating diode bridge failure sensor (RBD), power factor controller for parallel operation (PFR/2), parallel devices (standard from ECO 40), air filters, IP43 and IP45 protections, marine IP23 + protection for SOLAS requirements and many others.

Deration coefficients

Altitude (meters)	Ambient temperature (Celsius)					
	25	40	45	50	55	60
≤ 1000	1.07	1	0.96	0.93	0.91	0.89
$> 1000 \leq 1500$	1.01	0.96	0.92	0.89	0.87	0.84
$> 1500 \leq 2000$	0.96	0.91	0.87	0.84	0.83	0.79
$> 2000 \leq 3000$	0.9	0.85	0.81	0.78	0.76	0.73

Notes on short circuit curves

The indicated coefficients have to be used to correct the three phase short circuit curves values as a function of the rated voltage.

The indicated coefficient have to be used to correct the three phase short circuit curves values as a function of the type of short circuit voltage.

50 Hz		60 Hz	
Voltage	Factor	Voltage	Factor
380	0.93X	415	0.85X
400	1X	440	0.90X
415	1.04X	460	0.95X
440	1.10X	480	1X

	3 phase	2 phase L-L	1 phase L-N
<i>Istantaneous</i>	1X	0.87X	1.30X
<i>Minimum</i>	1X	1.80X	3.20X
<i>Sustained</i>	1X	1.50X	2.50X
<i>Max Duration</i>	20 sec.	10 sec.	4 sec.

All the curves are shown for series or parallel star connection at 400V 50 Hz or 480V 60 Hz. If the unit is reconnected from series to parallel star, the additional coefficient is 2X. From series star to series delta, it is 1.72X. From series star to parallel delta, it is 3.44X.

General characteristics

Pole number	4	Insulation class	H
Phase number	3	Protection class	IP23
Number of wires	12	NDE Bearing type	6324
Execution	Brushless	DE Bearing type	6330
Regulator type	DER-1/A	Maximum Overspeed	2250
Winding pitch	2/3	Altitude	0-1000
Code voltage reference	T0405P3	Balancing	ISO1940-1

Ratings 50Hz

kVA / kW @ Temp. Rise / Ambient °C - 0.8 PF

	STANDBY-163/27				STANDBY-150/40				H-125/40				F-105/40				B-80/40				
Series	760V	800V	830V	880V	760V	800V	830V	880V	760V	800V	830V	880V	760V	800V	830V	880V	760V	800V	830V	880V	
Parallel Star YY	380V	400V	415V	440V	380V	400V	415V	440V	380V	400V	415V	440V	380V	400V	415V	440V	380V	400V	415V	440V	
Series Delta Δ	440V	460V	480V	508V	440V	460V	480V	508V	440V	460V	480V	508V	440V	460V	480V	508V	440V	460V	480V	508V	
Parallel Delta ΔΔ	220V	230V	240V	254V	220V	230V	240V	254V	220V	230V	240V	254V	220V	230V	240V	254V	220V	230V	240V	254V	
ECO46 1S4 A	kVA	1650	1650	1650	1400	1552	1552	1552	1340	1500	1500	1500	1300	1350	1350	1350	1170	1200	1200	1200	1040
	kW	1320	1320	1320	1120	1242	1242	1242	1072	1200	1200	1200	1040	1080	1080	1080	936	960	960	960	832
ECO46 1.5S4 A	kVA	1800	1800	1800	1620	1700	1700	1700	1545	1650	1650	1650	1500	1480	1480	1480	1360	1320	1320	1320	1200
	kW	1440	1440	1440	1296	1360	1360	1360	1236	1320	1320	1320	1200	1184	1184	1184	1088	1056	1056	1056	960
ECO46 2S4 A	kVA	1944	1944	1944	1720	1863	1863	1863	1650	1800	1800	1800	1600	1600	1600	1600	1440	1440	1440	1440	1280
	kW	1555	1555	1555	1376	1490	1490	1490	1320	1440	1440	1440	1280	1280	1280	1280	1152	1152	1152	1152	1024
ECO46 1L4 A	kVA	2268	2268	2268	1990	2173	2173	2173	1900	2100	2100	2100	1850	1900	1900	1900	1660	1680	1680	1680	1480
	kW	1814	1814	1814	1592	1738	1738	1738	1520	1680	1680	1680	1480	1520	1520	1520	1328	1344	1344	1344	1184
ECO46 1.5L4 A	kVA	2500	2500	2500	2375	2380	2380	2380	2275	2300	2300	2300	2200	2050	2050	2050	1950	1840	1840	1840	1760
	kW	2000	2000	2000	1900	1904	1904	1904	1820	1840	1840	1840	1760	1640	1640	1640	1560	1472	1472	1472	1408
ECO46 2L4 A	kVA	2700	2700	2700	2450	2588	2588	2588	2350	2500	2500	2500	2280	2250	2250	2250	2050	2000	2000	2000	1824
	kW	2160	2160	2160	1960	2070	2070	2070	1880	2000	2000	2000	1824	1800	1800	1800	1640	1600	1600	1600	1459
ECO46 VL4 A	kVA	2916	3024	2916	2150	2795	2899	2795	2060	2700	2800	2700	2000	2400	2500	2400	1780	2160	2240	2160	1600
	kW	2333	2419	2333	1720	2236	2319	2236	1648	2160	2240	2160	1600	1920	2000	1920	1424	1728	1792	1728	1280

Ratings 60Hz

kVA / kW @ Temp. Rise / Ambient °C - 0.8 PF

	STANDBY-163/27				STANDBY-150/40				H-125/40				F-105/40				B-80/40				
Series	830V	880V	920V	960V	830V	880V	920V	960V	830V	880V	920V	960V	830V	880V	920V	960V	830V	880V	920V	960V	
Parallel Star YY	415V	440V	460V	480V	415V	440V	460V	480V	415V	440V	460V	480V	415V	440V	460V	480V	415V	440V	460V	480V	
Series Delta Δ	480V	504V	530V	554V	480V	504V	530V	554V	480V	504V	530V	554V	480V	504V	530V	554V	480V	504V	530V	554V	
Parallel Delta ΔΔ	240V	254V	265V	277V	240V	254V	265V	277V	240V	254V	265V	277V	240V	254V	265V	277V	240V	254V	265V	277V	
ECO46 1S4 A	kVA	1728	1847	1944	1944	1656	1770	1870	1870	1600	1710	1800	1800	1440	1530	1620	1620	1280	1368	1440	1440
	kW	1382	1478	1555	1555	1325	1416	1496	1496	1280	1368	1440	1440	1152	1224	1296	1296	1024	1094	1152	1152
ECO46 1.5S4 A	kVA	1870	2030	2140	2140	1782	1936	2040	2040	1730	1880	1980	1980	1570	1690	1780	1780	1384	1504	1584	1584
	kW	1496	1624	1712	1712	1426	1549	1632	1632	1384	1504	1584	1584	1256	1352	1424	1424	1107	1203	1267	1267
ECO46 2S4 A	kVA	2116	2213	2332	2332	2028	2122	2236	2236	1950	2050	2160	2160	1750	1820	1920	1920	1560	1640	1728	1728
	kW	1693	1770	1866	1866	1622	1698	1789	1789	1560	1640	1728	1728	1400	1456	1536	1536	1248	1312	1382	1382
ECO46 1L4 A	kVA	2480	2582	2722	2722	2370	2473	2608	2608	2300	2390	2520	2520	2070	2150	2280	2280	1840	1912	2016	2016
	kW	1984	2066	2178	2178	1896	1978	2086	2086	1840	1912	2016	2016	1656	1720	1824	1824	1472	1530	1613	1613
ECO46 1.5L4 A	kVA	2613	2829	2980	2980	2508	2715	2860	2860	2420	2620	2760	2760	2150	2330	2460	2460	1936	2096	2208	2208
	kW	2090	2263	2384	2384	2006	2172	2288	2288	1936	2096	2208	2208	1720	1864	1968	1968	1549	1677	1766	1766
ECO46 2L4 A	kVA	2920	3067	3240	3240	2800	2939	3105	3105	2700	2840	3000	3000	2430	2550	2700	2700	2160	2272	2400	2400
	kW	2336	2454	2592	2592	2240	2351	2484	2484	2160	2272	2400	2400	1944	2040	2160	2160	1728	1818	1920	1920
ECO46 VL4 A	kVA	3136	3375	3575	3683	3007	3234	3426	3529	2900	3125	3310	3410	2600	2800	2980	3050	2320	2500	2648	2728
	kW	2509	2700	2860	2946	2406	2587	2741	2823	2320	2500	2648	2728	2080	2240	2384	2440	1856	2000	2118	2182

Reactance & Time constants- Class H / 400V

Unsaturated (ref. EN60034-4)			ECO46 1S4 A	ECO46 1.5S4 A	ECO46 2S4 A	ECO46 1L4 A	ECO46 1.5L4 A	ECO46 2L4 A	ECO46 VL4 A
X_d	Direct-axis synchronous reactance	%	273,5	296,4	273,7	253,8	289,1	270,4	247,5
X'_d	Direct-axis transient reactance	%	26,5	29,3	25,9	25,3	27,9	25,6	25,5
X''_d	Direct-axis subtransient reactance	%	13,4	14,3	12,7	12,3	13,6	12,4	12,1
X_q	Quadrature-axis synchronous reactance	%	174,7	189,8	170,6	177,8	205,9	191,4	177,8
X'_q	Quadrature-axis transient reactance	%	174,7	189,8	170,6	177,8	205,9	191,4	177,8
X''_q	Quadrature-axis subtransient reactance	%	29,3	32,6	28,9	27,6	29,3	27	22,3
X₂	Negative-sequence reactance	%	19,2	20,5	18,1	17,5	19,4	17,5	14,9
X₀	Zero sequence reactance	%	4,26	4,78	4,06	3,85	4,58	3,89	3,74
Saturated									
X_d	Direct-axis synchronous reactance	%	227	246	227,2	210,6	240	224,4	205,4
X'_d	Direct-axis transient reactance	%	22	24,3	21,5	21	23,1	21,3	21,1
X''_d	Direct-axis subtransient reactance	%	11,1	11,9	10,5	10,2	11,3	10,3	10
X_q	Quadrature-axis synchronous reactance	%	145	157,5	141,6	147,6	170,9	158,9	147,6
X'_q	Quadrature-axis transient reactance	%	145	157,5	141,6	147,6	170,9	158,9	147,6
X''_q	Quadrature-axis subtransient reactance	%	24,3	27,1	24	22,9	24,3	22,4	18,5
X₂	Negative-sequence reactance	%	15,9	17	15	14,5	16,1	14,5	12,3
X₀	Zero sequence reactance	%	4,26	4,78	4,06	3,85	4,58	3,89	3,74
K_{cc}	Short circuit ratio		0,38	0,35	0,38	0,41	0,36	0,4	0,42
T'_d	Transient time constant	sec	0,25	0,264	0,258	0,265	0,27	0,275	0,291
T''_d	Subtransient time constant	sec	0,021	0,024	0,023	0,022	0,022	0,024	0,035
T'_{do}	Open circuit time constant	sec	9,5	10,8	10,4	11	10,4	12,5	13,1
T_a	Armature time constant	sec	0,027	0,03	0,029	0,031	0,031	0,034	0,04

Additional information - Class H / 400V

I₀	Excitation current at no load	A	0,7	0,9	0,75	0,8	1,0	0,9	1,1
I_c	Excitation current at full load	A	2,9	2,8	3,0	2,9	3,1	3,1	3,7
Overload			1 hour in a 6 hours period 110% rated load						
Overload per 20 sec.		%	300						
Heat dissipation		W	47401	50716	53776	59130	62792	66116	71662
Telephone Harmonic Factor - THF		%	<2	<2	<2	<2	<2	<2	<2
Waveform Distors.(THD) full load LL/LN		%	3 / 2,9	3,3 / 3,2	3,4 / 3,3	3,3 / 2,9	2,8 / 2,8	2,7 / 2,8	2,6 / 2,5
Waveform Distors.(THD) no load LL/LN		%	2,5 / 2,4	2,9 / 3	2,9 / 2,8	2,7 / 2,6	2,9 / 2,9	2,8 / 2,6	2,7 / 2,5

Reactance & Time constants- Class H / 480V

Unsaturated (ref. EN60034-4)			ECO46 1S4 A	ECO46 1.5S4 A	ECO46 2S4 A	ECO46 1L4 A	ECO46 1.5L4 A	ECO46 2L4 A	ECO46 VL4 A
X_d	Direct-axis synchronous reactance	%	273,5	296,4	273,7	253,8	289,1	270,4	260,5
X'_d	Direct-axis transient reactance	%	26,5	29,3	25,9	25,3	27,9	25,6	26,8
X''_d	Direct-axis subtransient reactance	%	13,4	14,3	12,7	12,3	13,6	12,4	12,7
X_q	Quadrature-axis synchronous reactance	%	174,7	189,8	170,6	177,8	205,9	191,4	187,2
X'_q	Quadrature-axis transient reactance	%	174,7	189,8	170,6	177,8	205,9	191,4	187,2
X''_q	Quadrature-axis subtransient reactance	%	29,3	32,6	28,9	27,6	29,3	27	23,4
X₂	Negative-sequence reactance	%	19,2	20,5	18,1	17,5	19,4	17,5	15,6
X₀	Zero sequence reactance	%	4,26	4,78	4,06	3,85	4,58	3,89	3,94
Saturated									
X_d	Direct-axis synchronous reactance	%	227	246	227,2	210,6	240	224,4	216,2
X'_d	Direct-axis transient reactance	%	22	24,3	21,5	21	23,1	21,3	22,3
X''_d	Direct-axis subtransient reactance	%	11,1	11,9	10,5	10,2	11,3	10,3	10,5
X_q	Quadrature-axis synchronous reactance	%	145	157,5	141,6	147,6	170,9	158,9	155,3
X'_q	Quadrature-axis transient reactance	%	145	157,5	141,6	147,6	170,9	158,9	155,3
X''_q	Quadrature-axis subtransient reactance	%	24,3	27,1	24	22,9	24,3	22,4	19,4
X₂	Negative-sequence reactance	%	15,9	17	15	14,5	16,1	14,5	13
X₀	Zero sequence reactance	%	4,26	4,78	4,06	3,85	4,58	3,89	3,94
K_{cc}	Short circuit ratio		0,38	0,35	0,38	0,41	0,36	0,4	0,42
T'_d	Transient time constant	sec	0,25	0,264	0,258	0,265	0,27	0,275	0,291
T''_d	Subtransient time constant	sec	0,021	0,024	0,023	0,022	0,022	0,024	0,035
T'_{do}	Open circuit time constant	sec	9,5	10,8	10,4	11	10,4	12,5	13,1
T_a	Armature time constant	sec	0,027	0,03	0,029	0,031	0,031	0,034	0,04

Additional information - Class H / 480V

I_o	Excitation current at no load	A	0,65	0,8	0,7	0,75	0,9	0,85	1,0	
I_c	Excitation current at full load	A	2,8	2,7	3,0	2,8	3,0	3,0	3,6	
Overload			1 hour in a 6 hours period 110% rated load							
Overload per 20 sec.		%							300	
Heat dissipation		W	53776	57451	60820	66645	70638	71679	78584	
Telephone Interference Factor - TIF			<40	<40	<40	<40	<40	<40	<40	
Waveform Distors.(THD) full load LL/LN		%	3 / 2,9	3,3 / 3,2	3,4 / 3,3	3,3 / 2,9	2,8 / 2,8	2,7 / 2,8	2,6 / 2,5	
Waveform Distors.(THD) no load LL/LN		%	2,5 / 2,4	2,9 / 3	2,9 / 2,8	2,7 / 2,6	2,9 / 2,9	2,8 / 2,6	2,7 / 2,5	

Efficiencies @ 50Hz

Models		380V 50Hz					400V 50Hz					415V 50Hz					440V 50Hz				
		0.25	0.5	0.75	1	1.1	0.25	0.5	0.75	1	1.1	0.25	0.5	0.75	1	1.1	0.25	0.5	0.75	1	1.1
ECO46 1S4 A	%	95,3	96,0	96,7	96,3	96,1	95,3	95,9	96,4	96,2	96,1	95,1	95,9	96,5	96,0	95,6	94,6	95,5	96,0	95,8	95,6
ECO46 1.5S4 A	%	93,8	96,1	96,8	96,4	96,2	93,8	96,0	96,5	96,3	96,1	93,6	96,1	96,6	96,1	95,7	93,1	95,7	96,4	95,9	95,6
ECO46 2S4 A	%	95,6	96,3	96,8	96,5	96,3	95,6	96,2	96,5	96,4	96,3	95,4	96,2	96,6	96,2	95,8	94,9	95,7	96,1	96,0	95,9
ECO46 1L4 A	%	95,6	96,5	97,1	96,7	96,5	95,6	96,4	96,8	96,6	96,5	95,4	96,4	96,9	96,4	96,0	94,9	95,8	96,4	96,2	96,1
ECO46 1.5L4 A	%	94,0	96,5	97,2	96,8	96,6	94,0	96,4	96,9	96,7	96,6	93,8	96,5	97,0	96,5	96,1	93,3	96,1	96,8	96,3	96,1
ECO46 2L4 A	%	95,6	96,7	97,3	96,9	96,7	95,9	96,6	97,0	96,8	96,6	95,7	96,6	97,1	96,6	96,2	95,1	96,0	96,5	96,4	96,3
ECO46 VL4 A	%	95,9	96,7	97,2	97,0	96,8	95,8	96,6	97,1	96,9	96,7	95,6	96,4	96,9	96,7	96,5	93,6	94,9	95,8	96,0	95,9

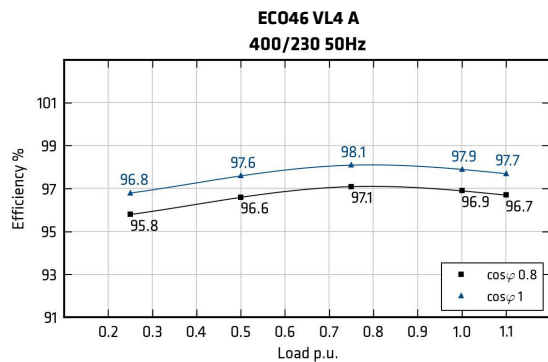
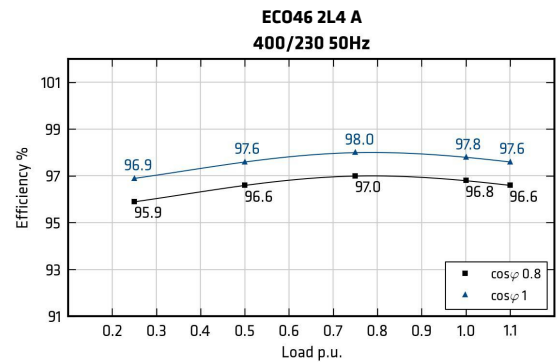
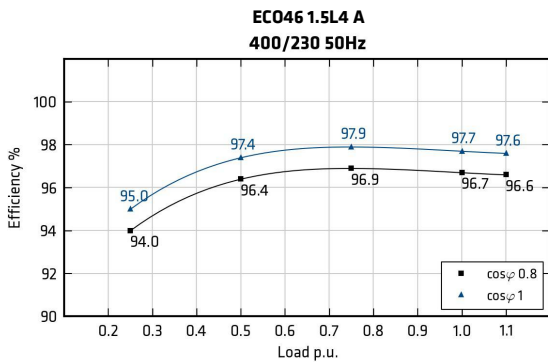
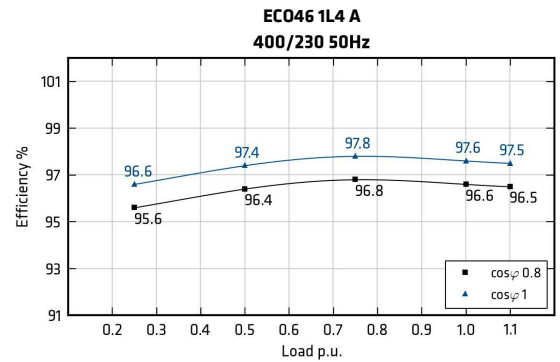
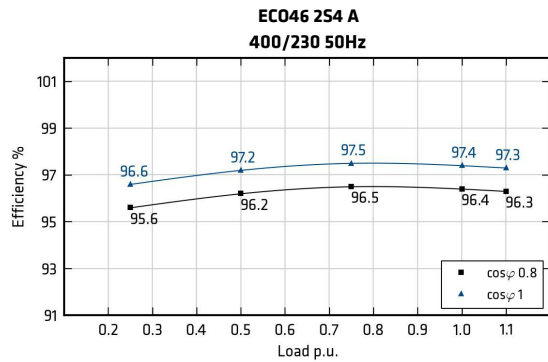
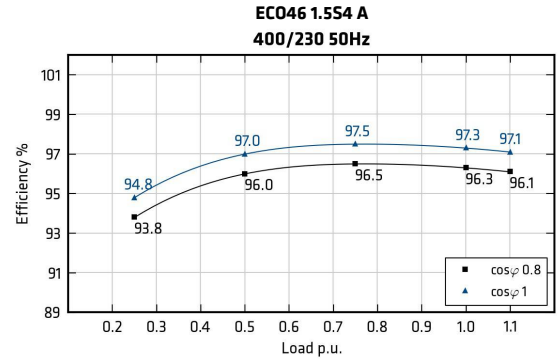
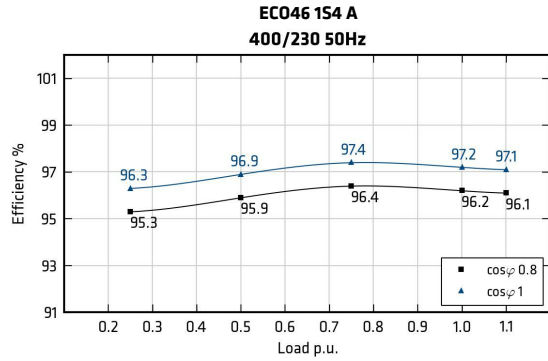

Efficiencies @ 60Hz

Models	415V 60Hz					440V 60Hz					460V 60Hz					480V 60Hz					
	0.25	0.5	0.75	1	1.1	0.25	0.5	0.75	1	1.1	0.25	0.5	0.75	1	1.1	0.25	0.5	0.75	1	1.1	
ECO46 1S4 A	%	94,8	95,6	96,2	96,1	95,9	95,2	96,0	96,5	96,3	96,2	95,3	96,2	96,9	96,5	96,3	95,4	96,1	96,6	96,4	96,3
ECO46 1.5S4 A	%	93,9	96,0	96,3	96,1	95,9	93,9	96,1	96,6	96,6	96,5	93,9	96,3	96,8	96,7	93,9	96,2	96,6	96,5	96,4	
ECO46 2S4 A	%	95,0	95,8	96,3	96,2	96,1	95,6	96,3	96,6	96,5	96,4	95,8	96,5	97,0	96,7	96,5	95,8	96,4	96,7	96,6	96,5
ECO46 1L4 A	%	95,3	96,1	96,6	96,5	96,4	95,9	96,5	96,9	96,7	96,6	95,8	96,7	97,3	96,9	96,7	95,9	96,6	97,0	96,8	96,7
ECO46 1.5L4 A	%	94,2	96,5	96,8	96,5	96,3	94,2	96,6	97,1	97,0	96,9	94,2	96,8	97,3	97,2	97,1	94,2	96,7	97,1	96,9	96,8
ECO46 2L4 A	%	95,6	96,4	96,9	96,8	96,7	96,2	96,8	97,2	97,0	96,9	96,2	97,0	97,6	97,2	97,0	96,2	96,9	97,3	97,1	97,0
ECO46 VL4 A	%	94,8	95,7	96,6	96,5	96,4	95,6	96,5	97,3	97,2	97,1	95,8	96,8	97,5	97,4	97,3	95,7	96,6	97,3	97,2	97,1

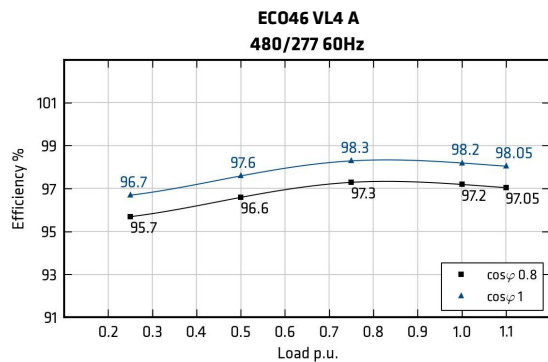
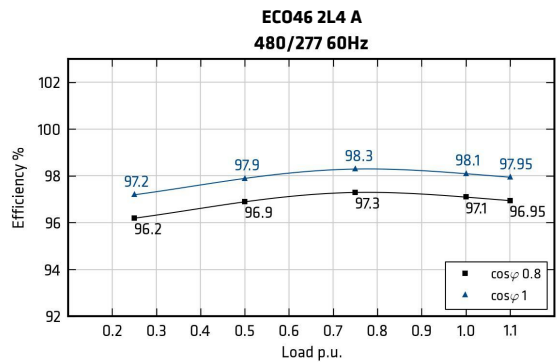
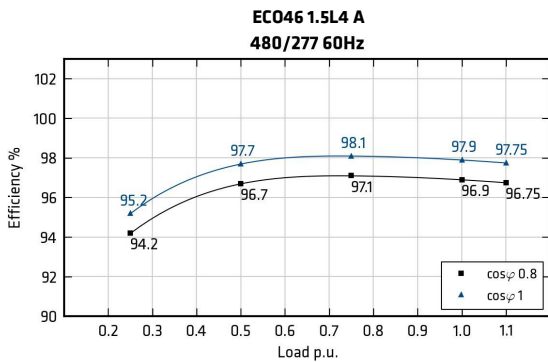
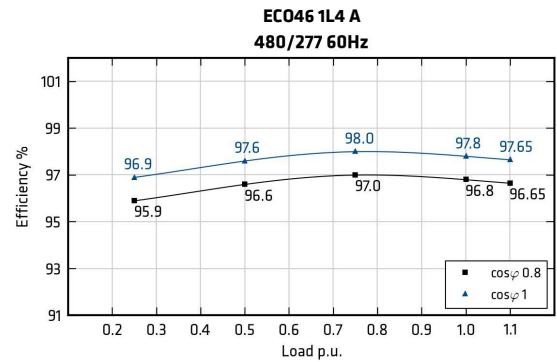
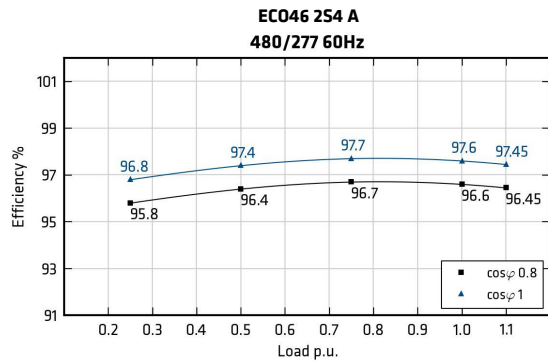
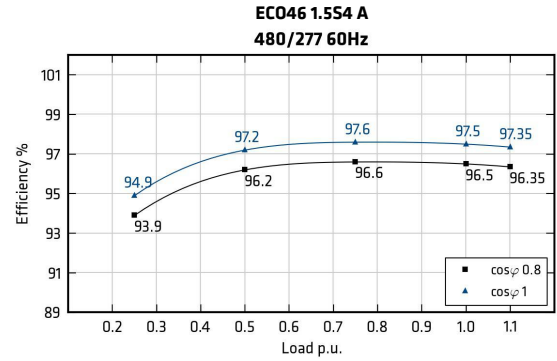
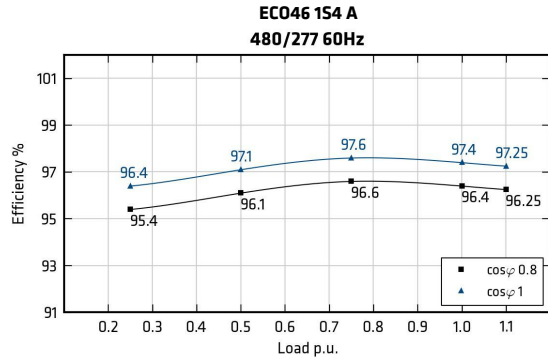

Transients voltage

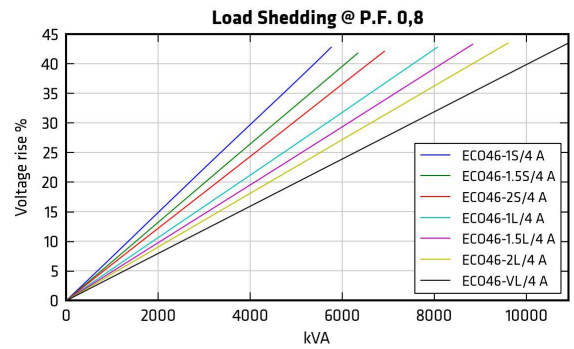
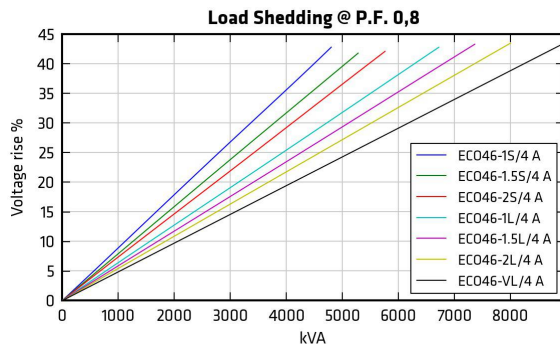
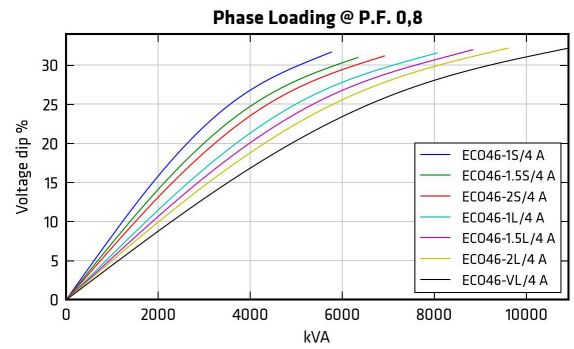
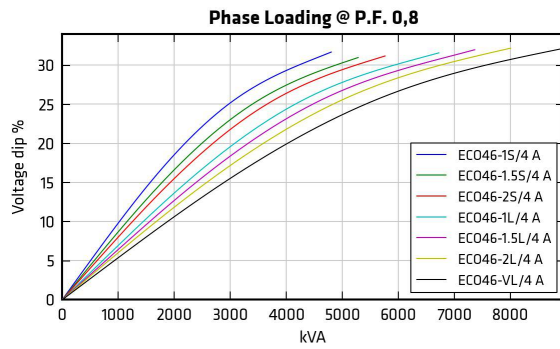
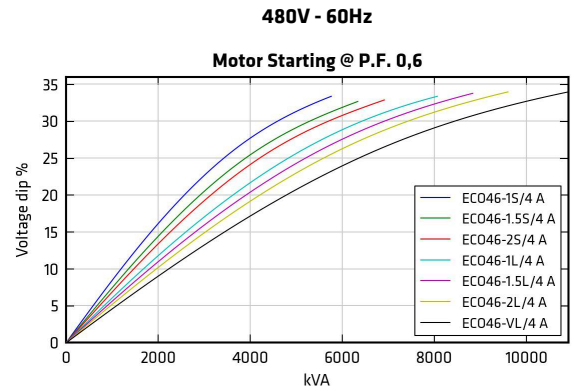
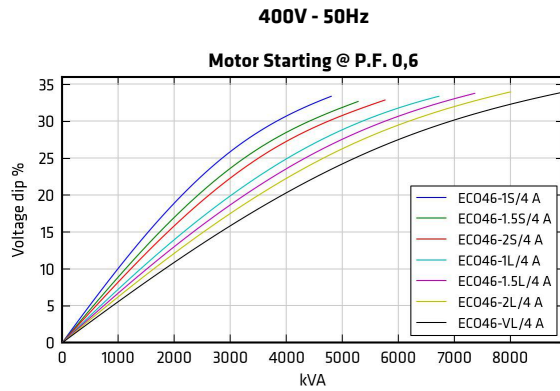

In order to scale transient curves as a function of a power factor or voltage if not indicated, please proceed as follows:

Power Factor coefficient corrector (PFCC), to be used on power factor 0.6 curves:

$$PFCC = \frac{\sin(\text{ARCCos}(PF_{\text{new}}))}{0.8}$$

Example. The PFCC at power factor 0.3 is 1.192 [$PFCC = \frac{\sin(\text{ARCCos}(0.3))}{0.8}$]. This means that the voltage fall at a given power at pf 0.3 is equivalent to the one that can be read on the pf 0.6 curve if the load is considered 1.192 times bigger (19% higher value.).

In this example, a 100 kVA load insertion at pf 0.3 is equivalent in voltage fall to a 119kVA load insertion at pf 0.6.

Voltage coefficient corrector (VCC):

$$VCC = \left(\frac{400}{V_{\text{new}}}\right)^2 \text{ if } 50 \text{ Hz}; \quad VCC = \left(\frac{480}{V_{\text{new}}}\right)^2 \text{ if } 60 \text{ Hz}$$

Example. VCC at 415V 60 Hz is 1.338 [$VCC = \left(\frac{480}{415}\right)^2$]. This means that the voltage fall at a given power at 415V is equivalent to the one that can be read on the power factor 0.6 curve if the load is considered 1.338 times bigger (33% higher value.).

In this example, a 100 kVA load insertion at 415V is equivalent in voltage fall to a 133kVA load insertion at 480V.

50Hz Short circuit decrement curves - No load excitation at rated speed

ECO46 1S4 A

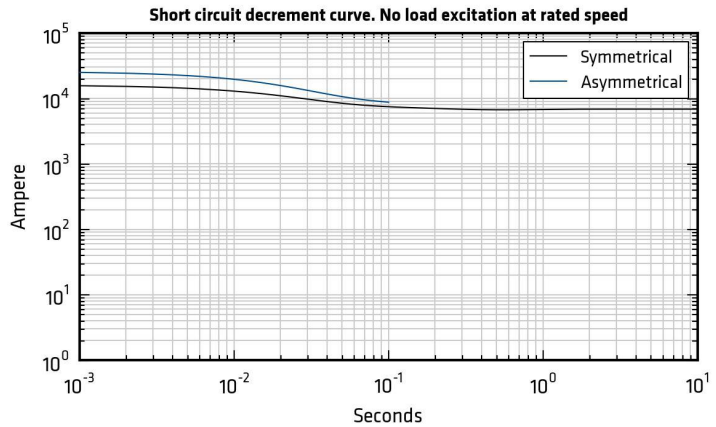

ECO46 1.5S4 A

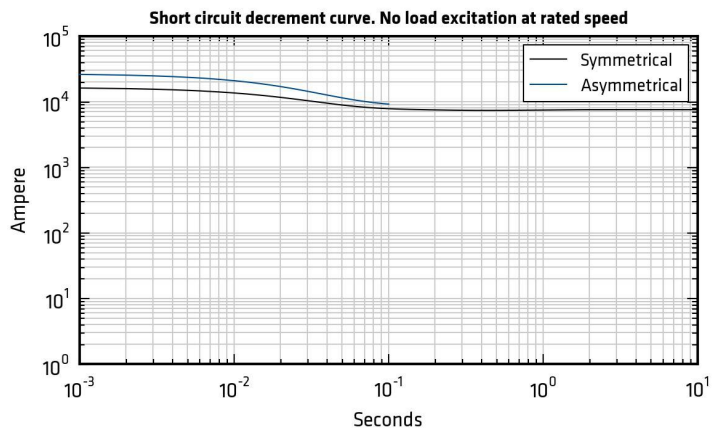

ECO46 2S4 A

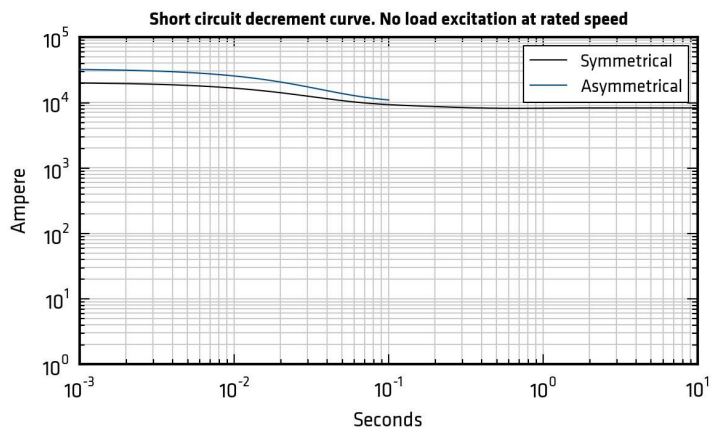

ECO46 1L4 A

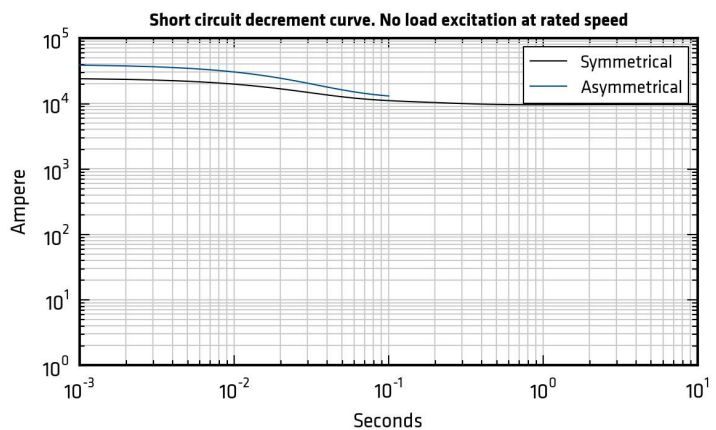

*Please refer to tables at page 6

50Hz Short circuit decrement curves - No load excitation at rated speed

ECO46 1.5L4 A

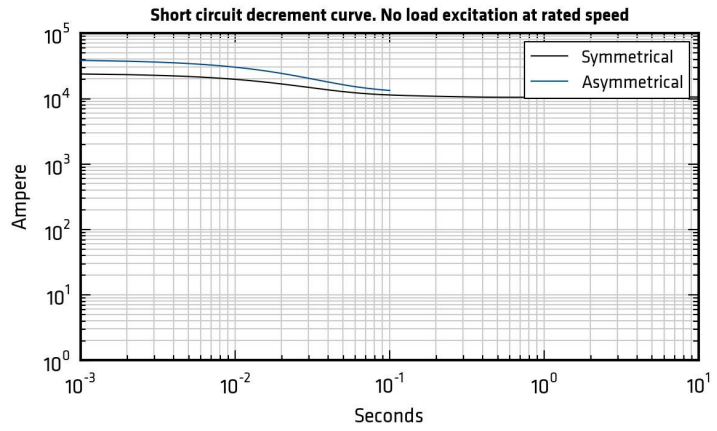

ECO46 2L4 A

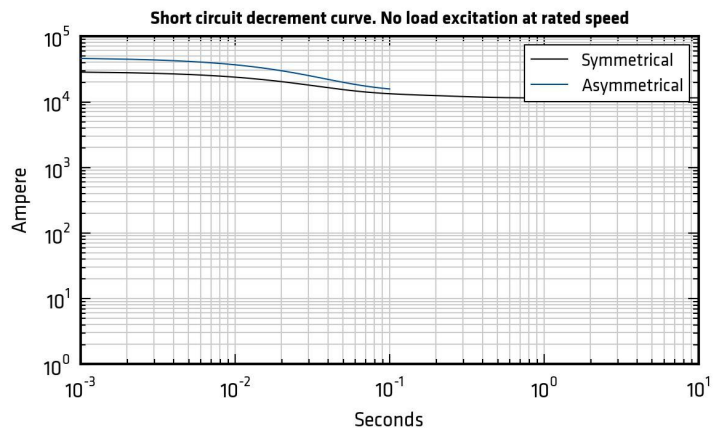

ECO46 VL4 A

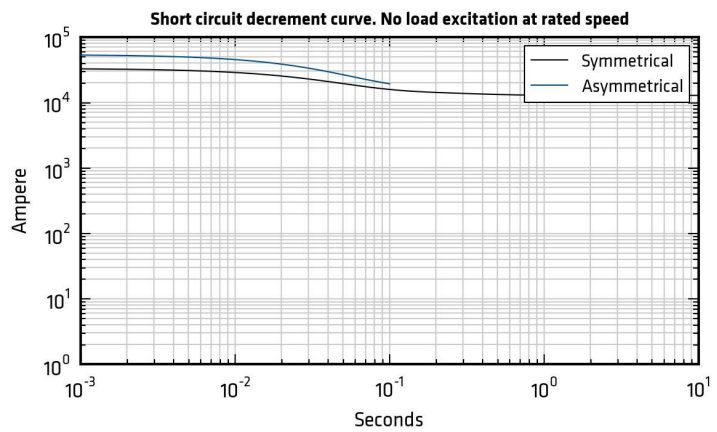

*Please refer to tables at page 6

60Hz Short circuit decrement curves - No load excitation at rated speed

ECO46 1S4 A

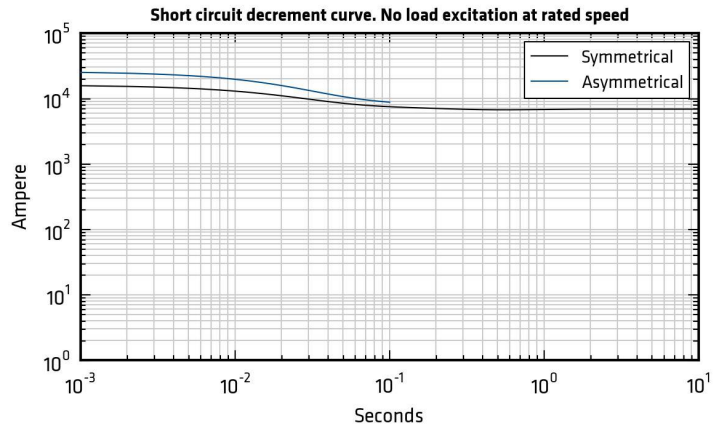

ECO46 1.5S4 A

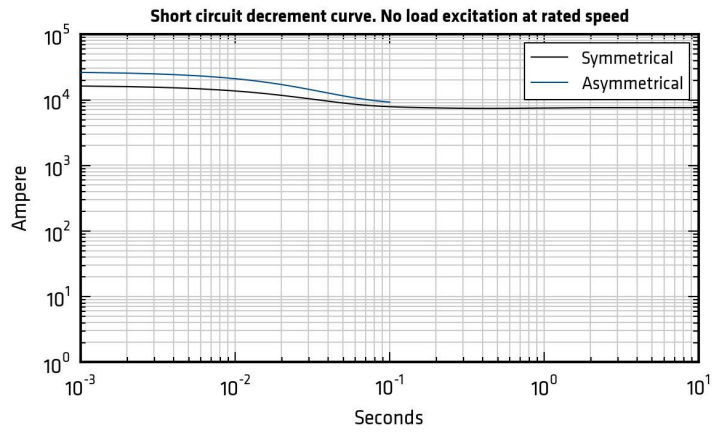

ECO46 2S4 A

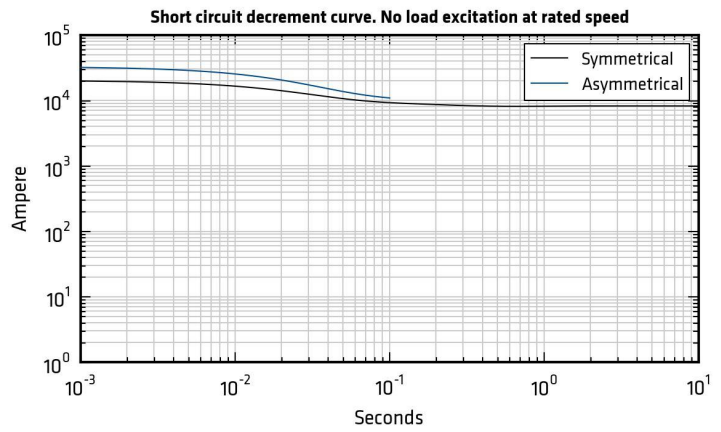

ECO46 1L4 A

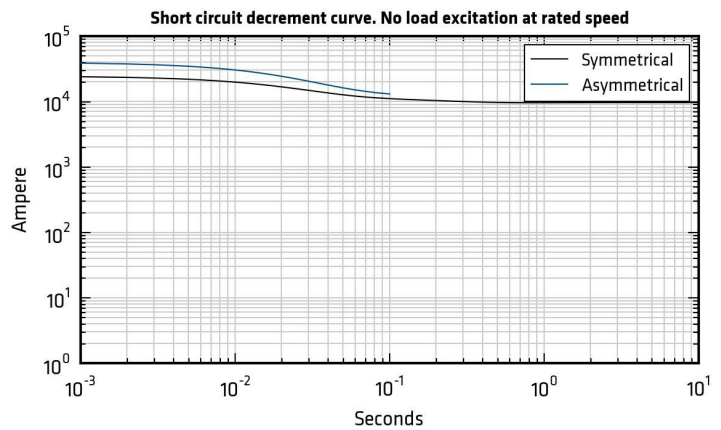

*Please refer to tables at page 6

60Hz Short circuit decrement curves - No load excitation at rated speed

ECO46 1.5L4 A

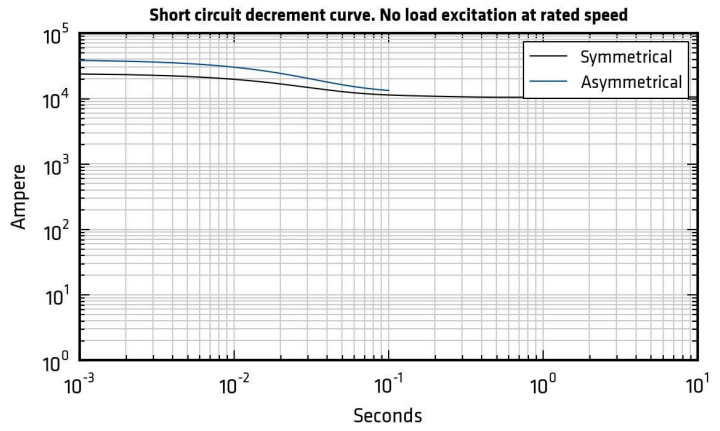

ECO46 2L4 A

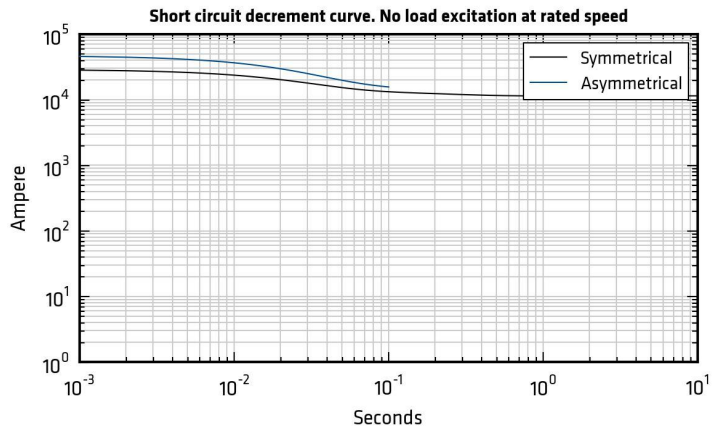

ECO46 VL4 A

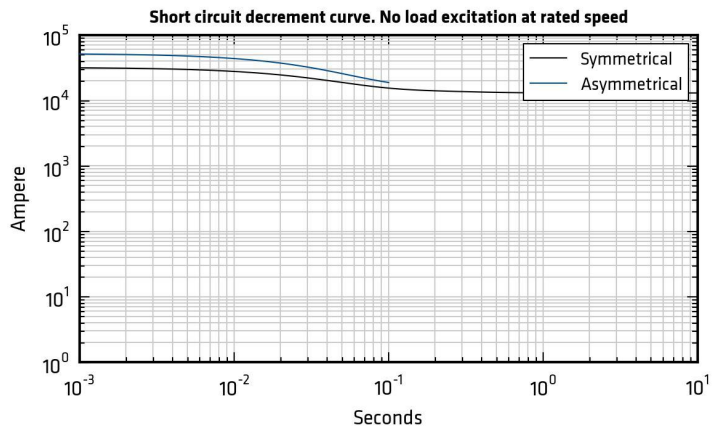

*Please refer to tables at page 6

Additional Characteristics

Data	ECO46 1S4 A		ECO46 1.5S4 A		ECO46 2S4 A		ECO46 1L4 A		ECO46 1.5L4 A		ECO46 2L4 A		ECO46 VL4 A	
	50Hz	60Hz	50Hz	60Hz	50Hz	60Hz	50Hz	60Hz	50Hz	60Hz	50Hz	60Hz	50Hz	60Hz
Damper cage	Copper													
Stator Winding Resistance (20°C)	Ω	0,006		0,003		0,004		0,003		0,003		0,002		0,001
Rotor Winding Resistance (20°C)	Ω	3,05		3,319		3,5		3,977		4,27		4,5		5,18
Stator Exciter Resistance (20°C)	Ω	12,9		12,9		12,9		12,9		12,9		12,9		12,9
Rotor Exciter Resistance (20°C)	Ω	0,12		0,12		0,12		0,12		0,12		0,12		0,12
Weight of complete generator	kg	3005,0		3375,0		3560,0		3805,0		4255,0		4375,0		5120,0
Unbalanced magnetic pull	kN/mm	6,4		6,4		6,5		6,8		6,9		7,0		8,0
Air flow	m ³ /min	135,0	162,0	135,0	162,0	135,0	162,0	135,0	162,0	135,0	162,0	135,0	162,0	135,0
Noise level at 1m/7m	dB(A)	97/86	100/91	97/86	100/91	97/86	100/91	97/86	100/91	97/86	100/91	97/86	100/91	97/86

PQ Diagram

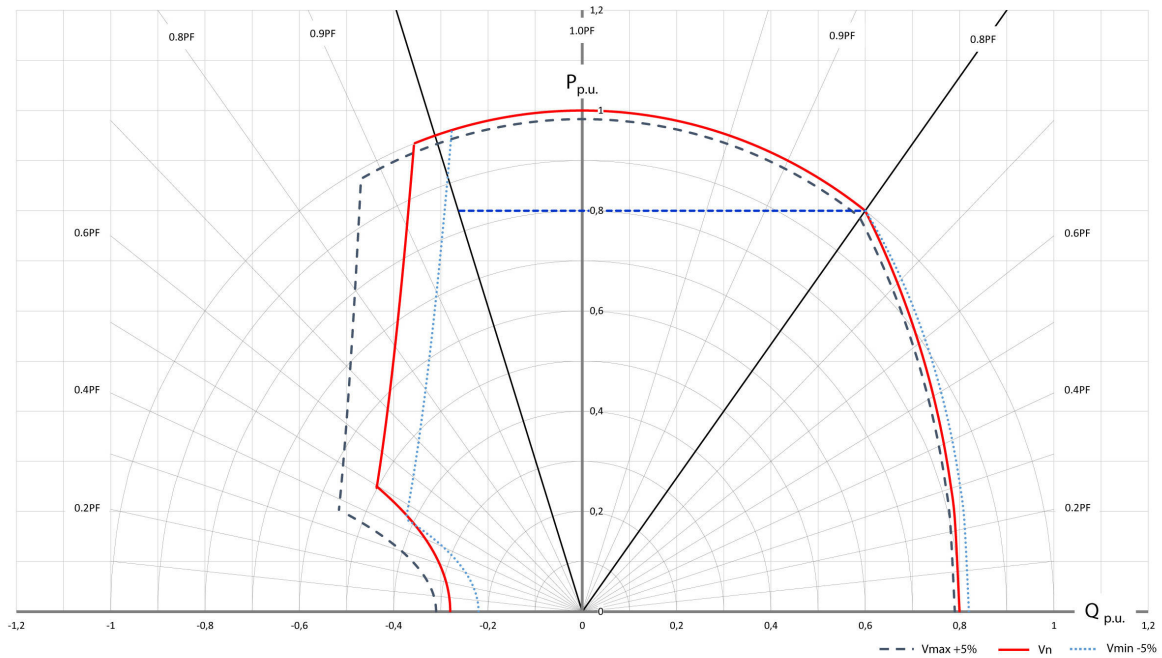

ECO46 1S4 A

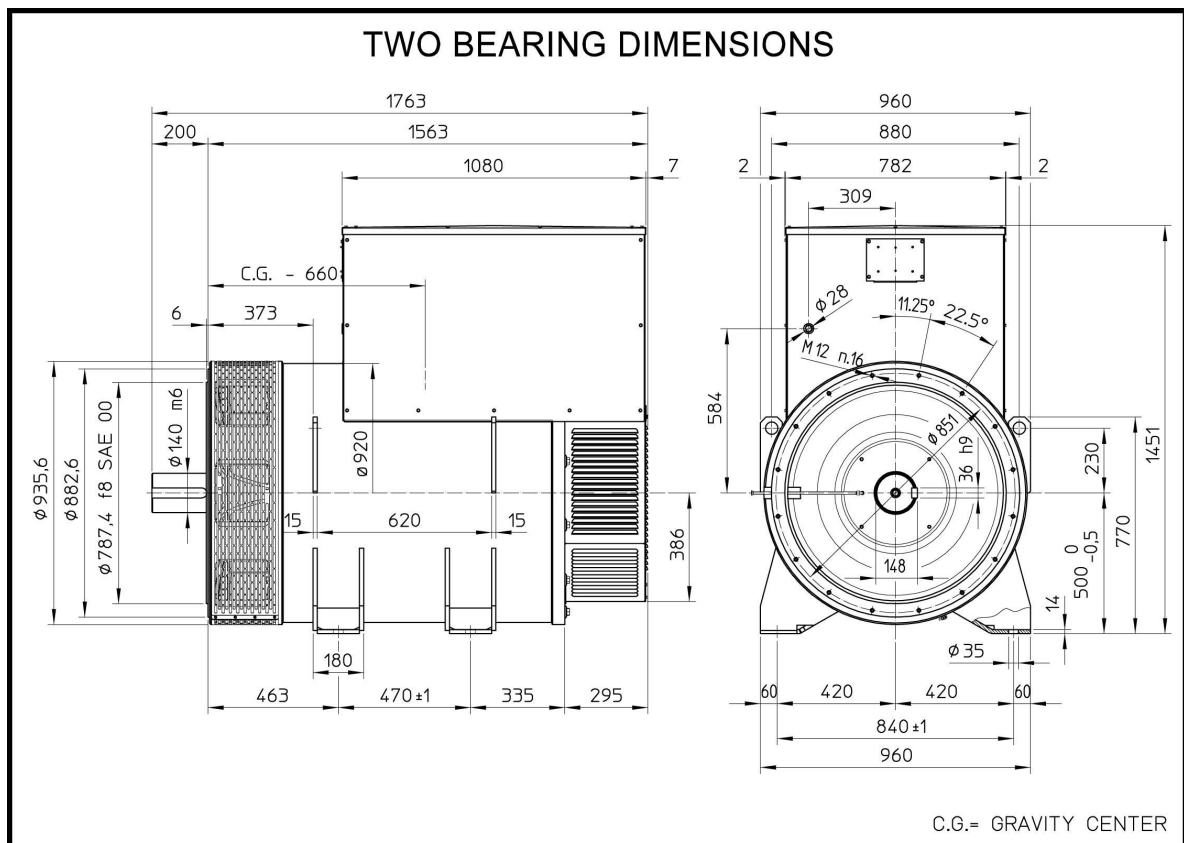
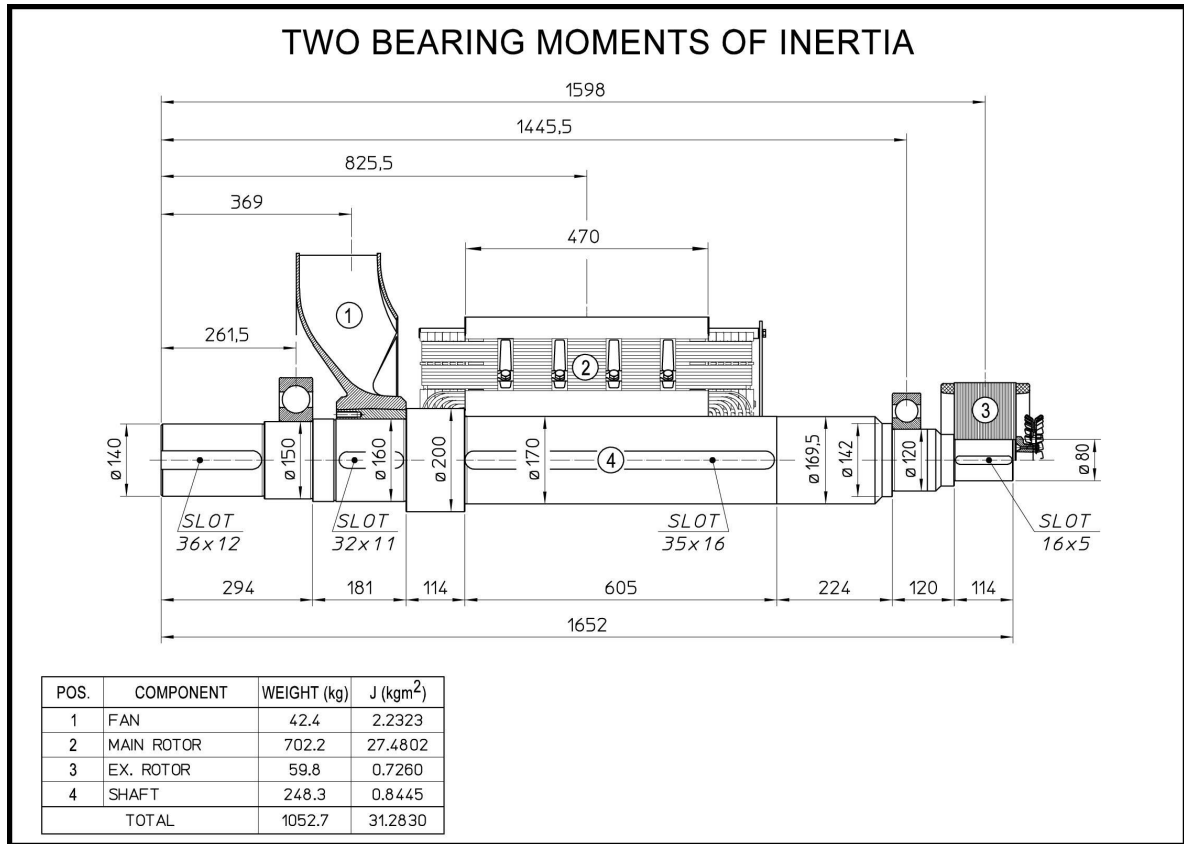

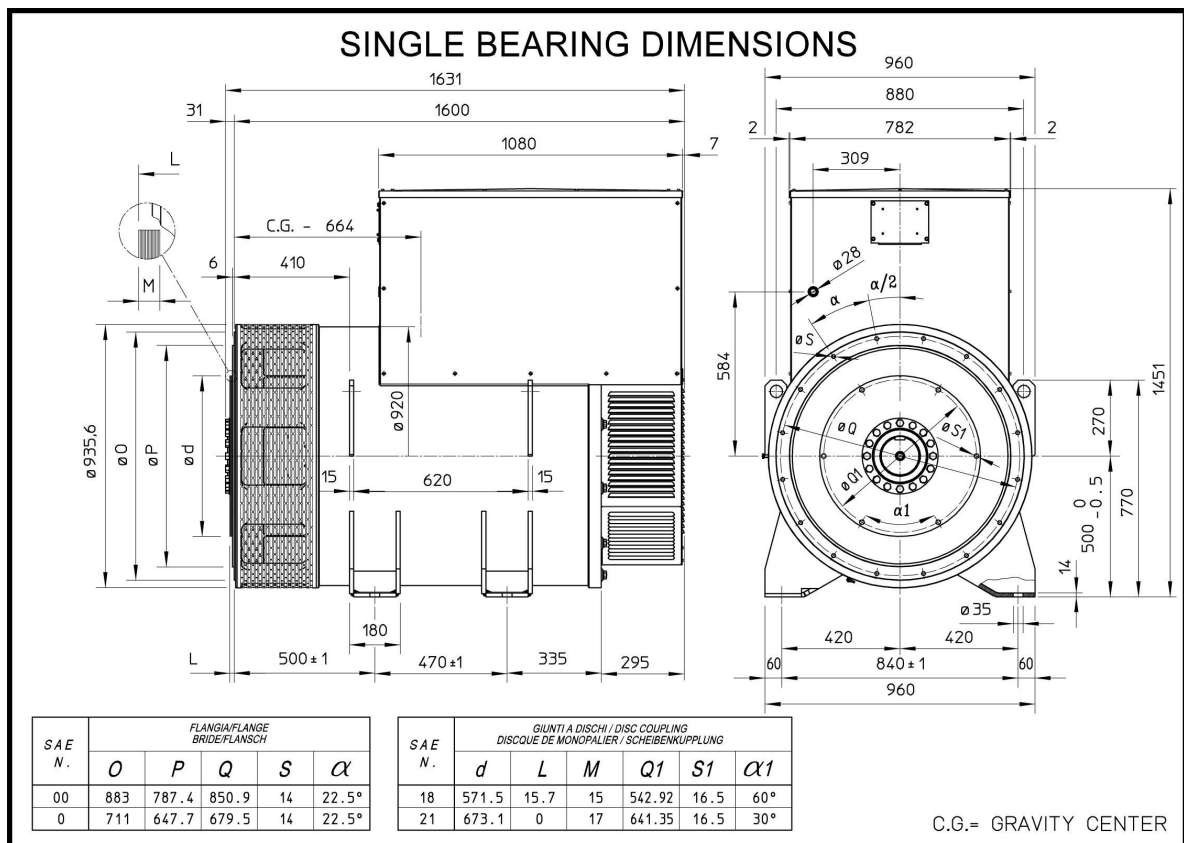
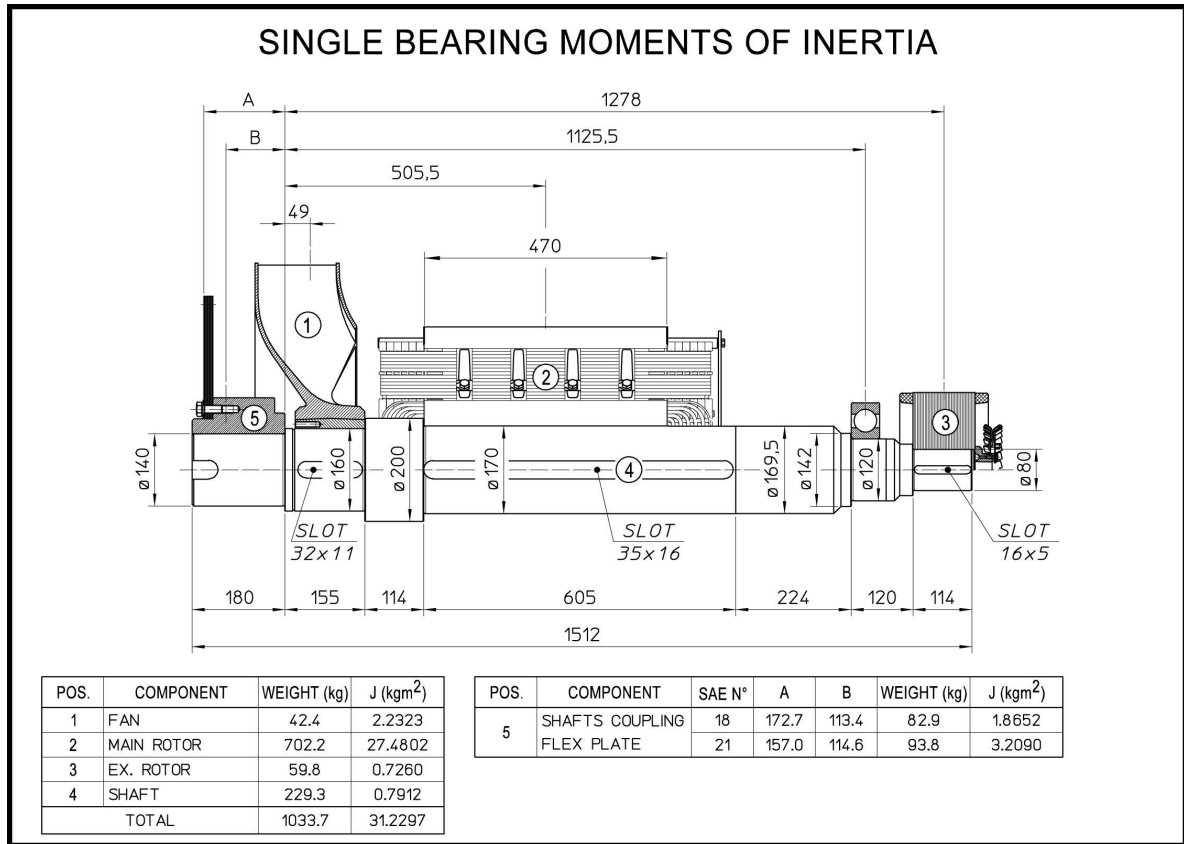

ECO46 1.5S4 A

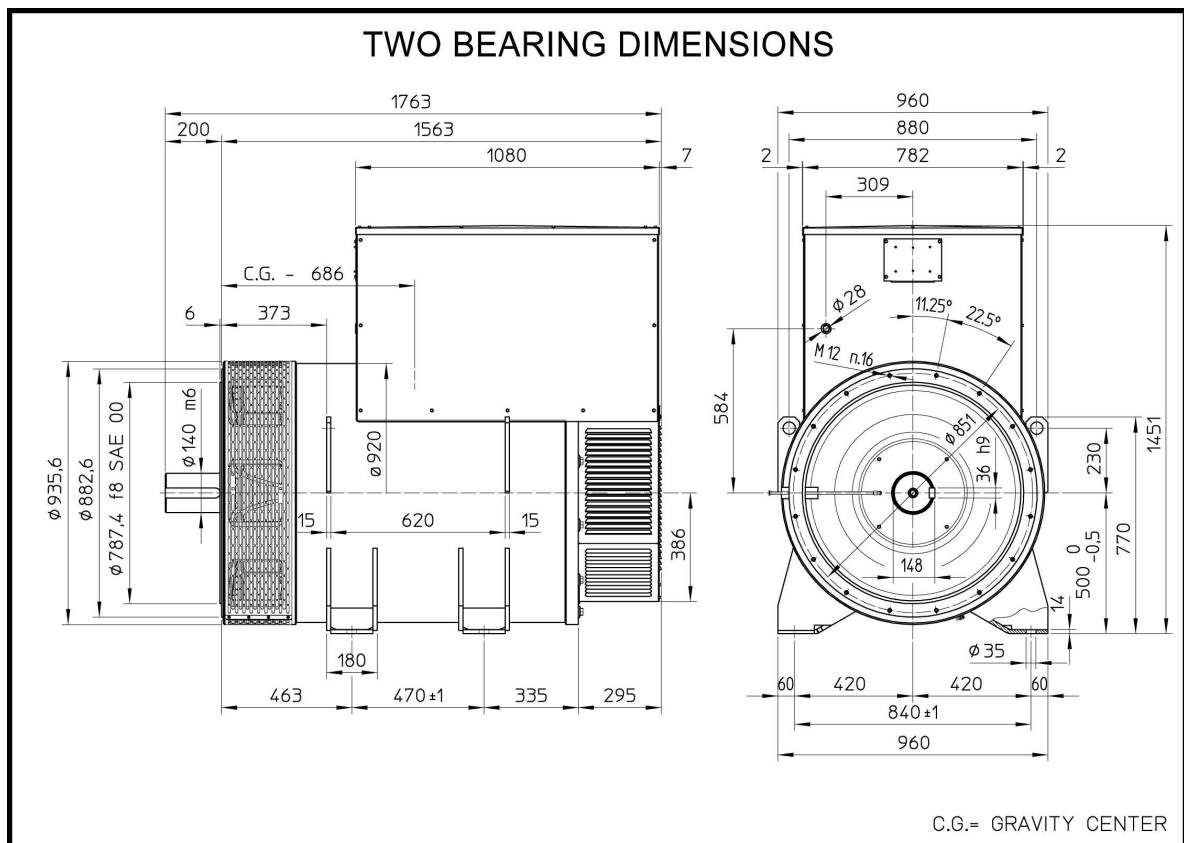
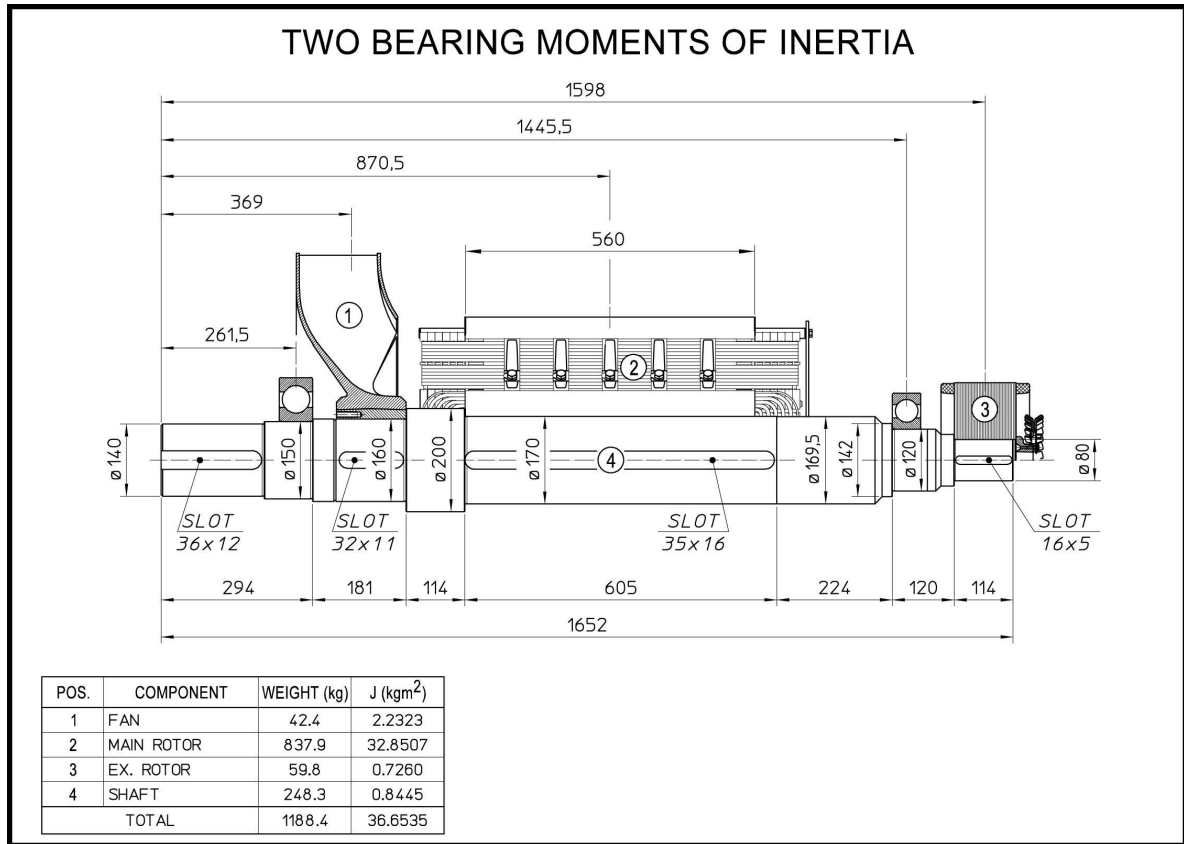

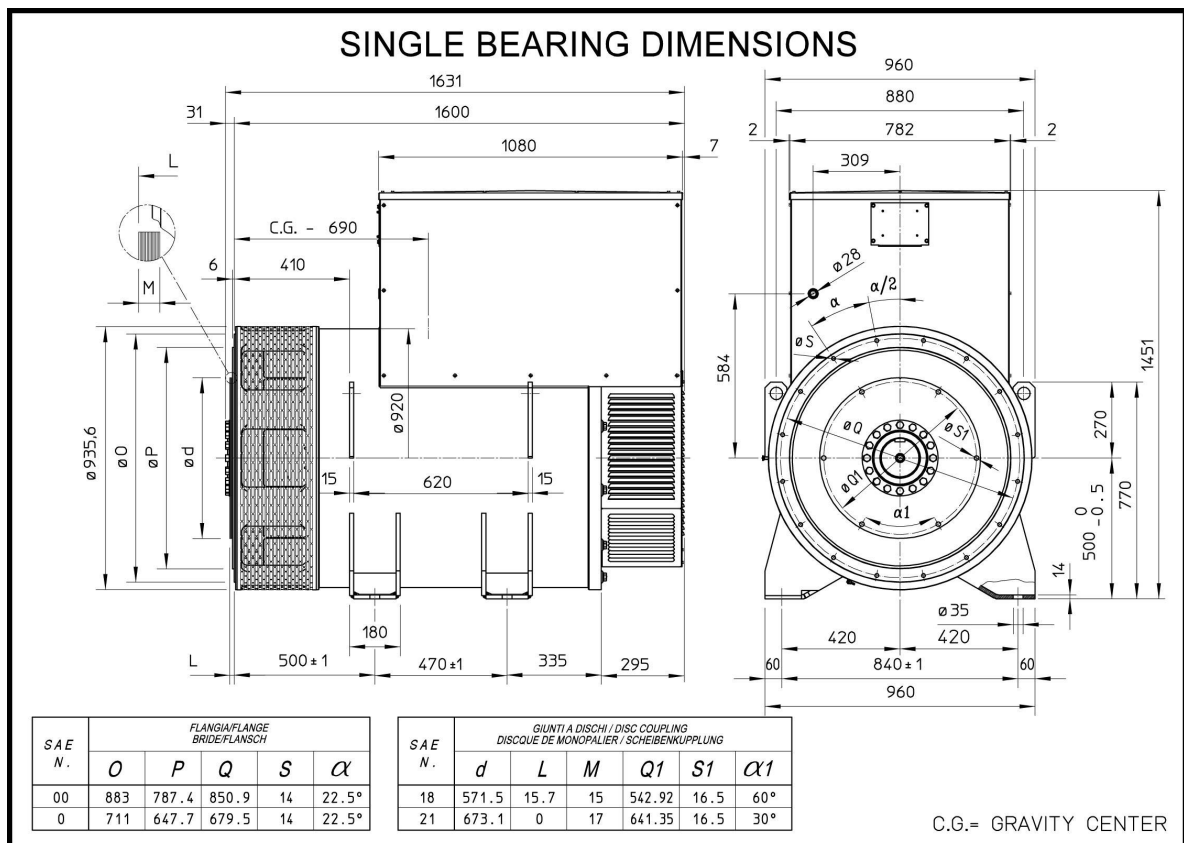
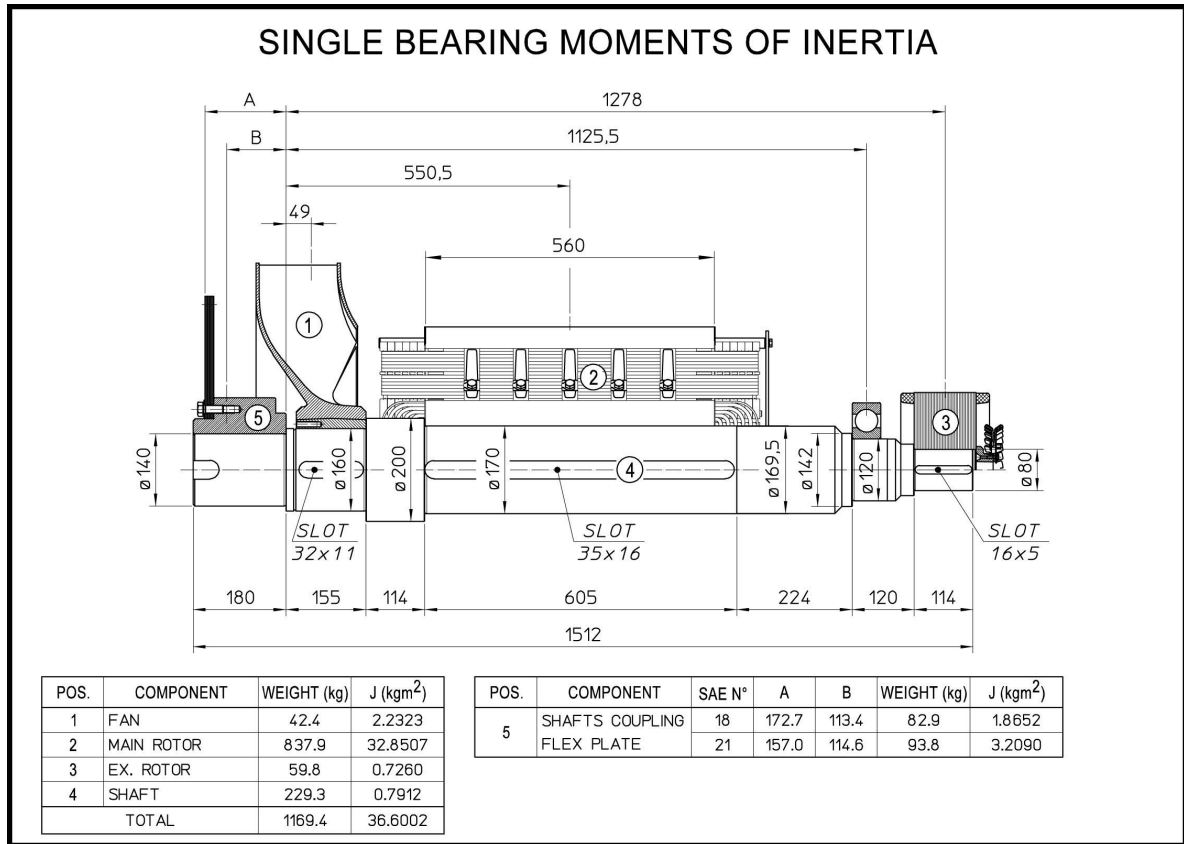

ECO46 2S4 A

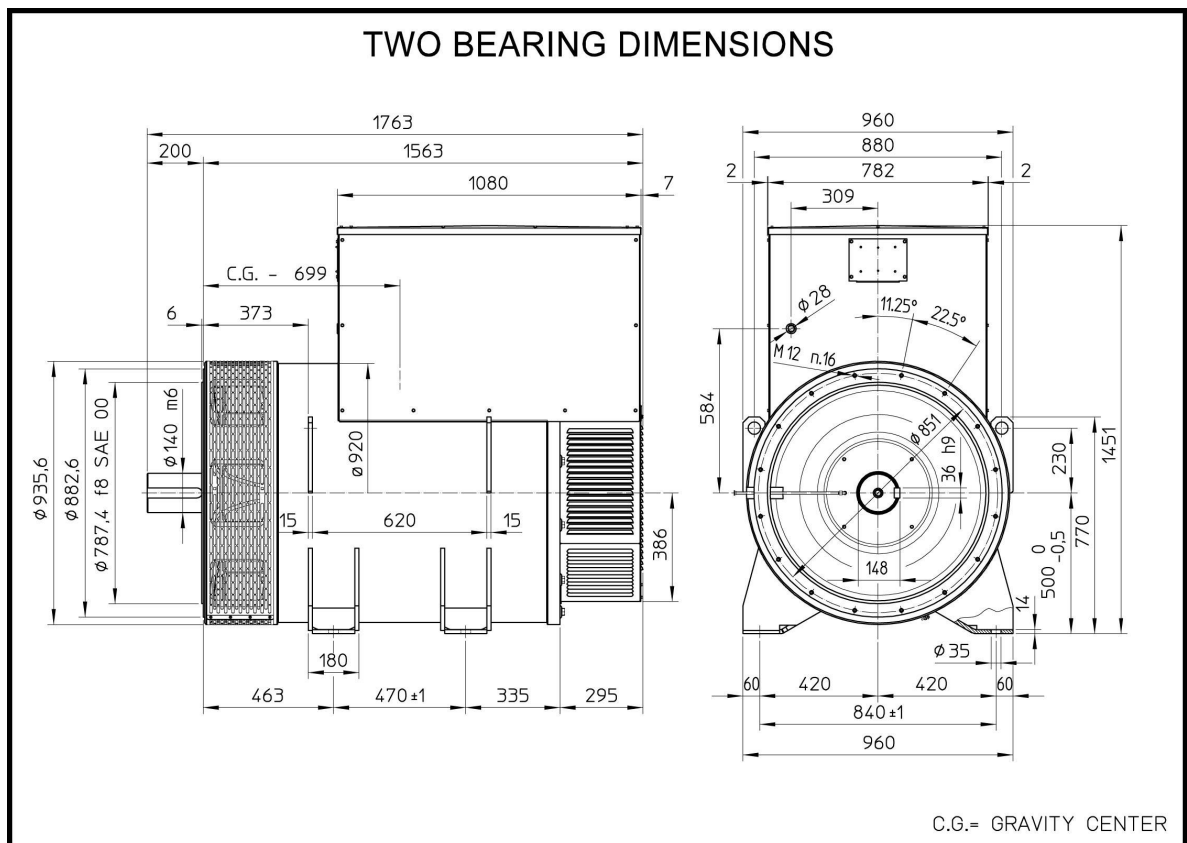
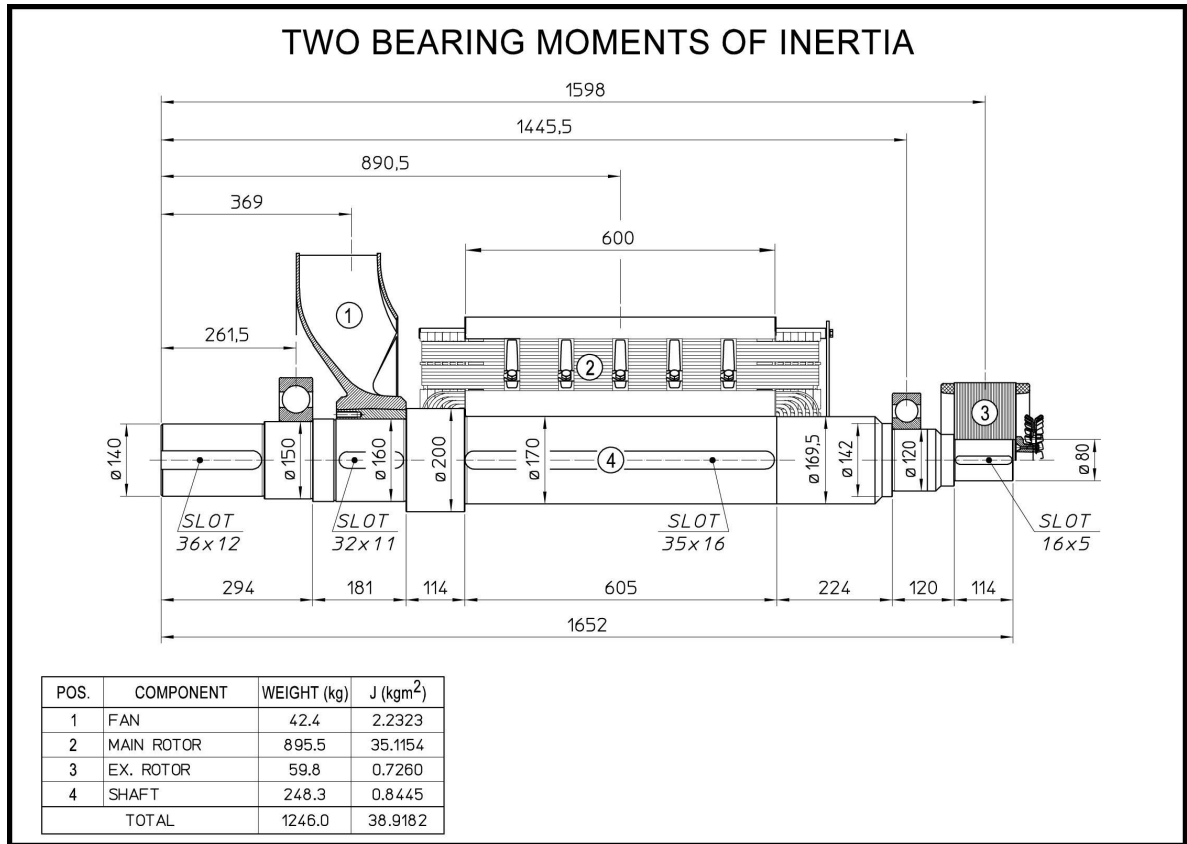

ECO46 2S4 A

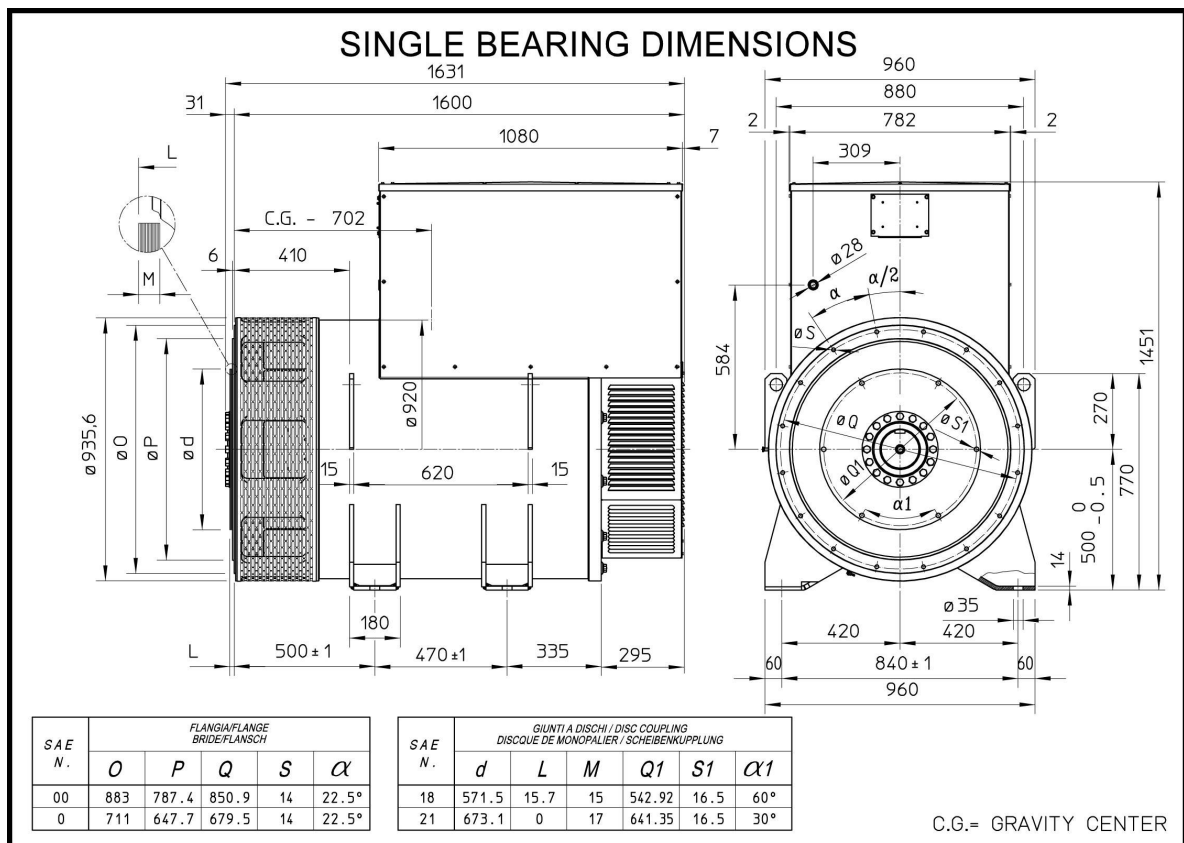
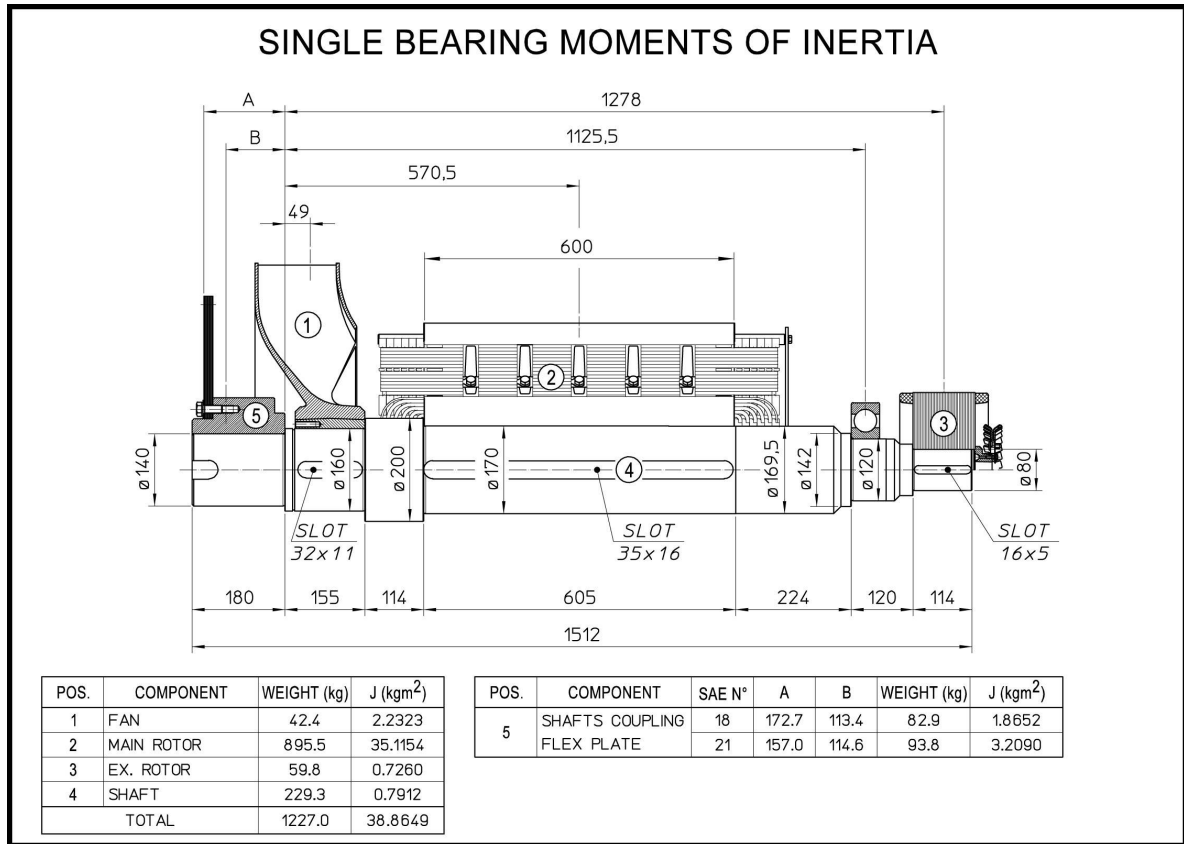

ECO46 1L4 A

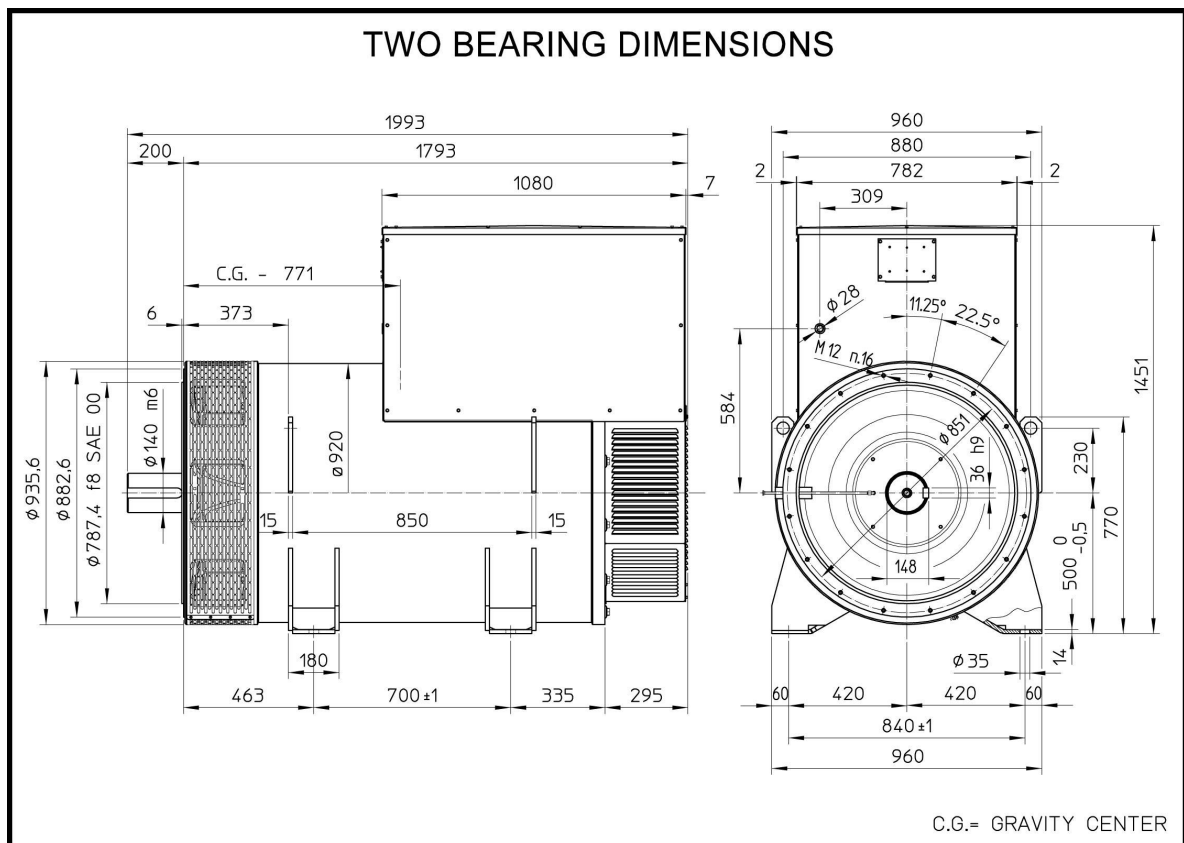
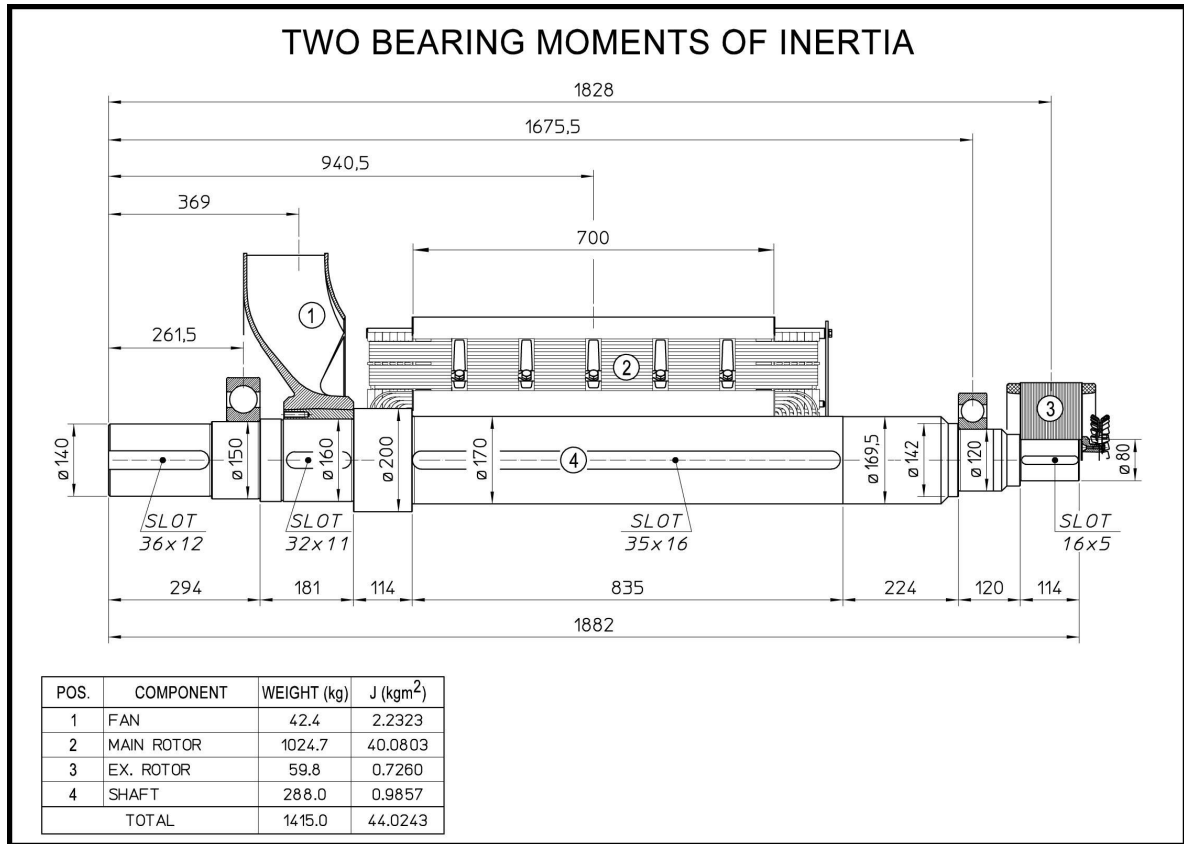

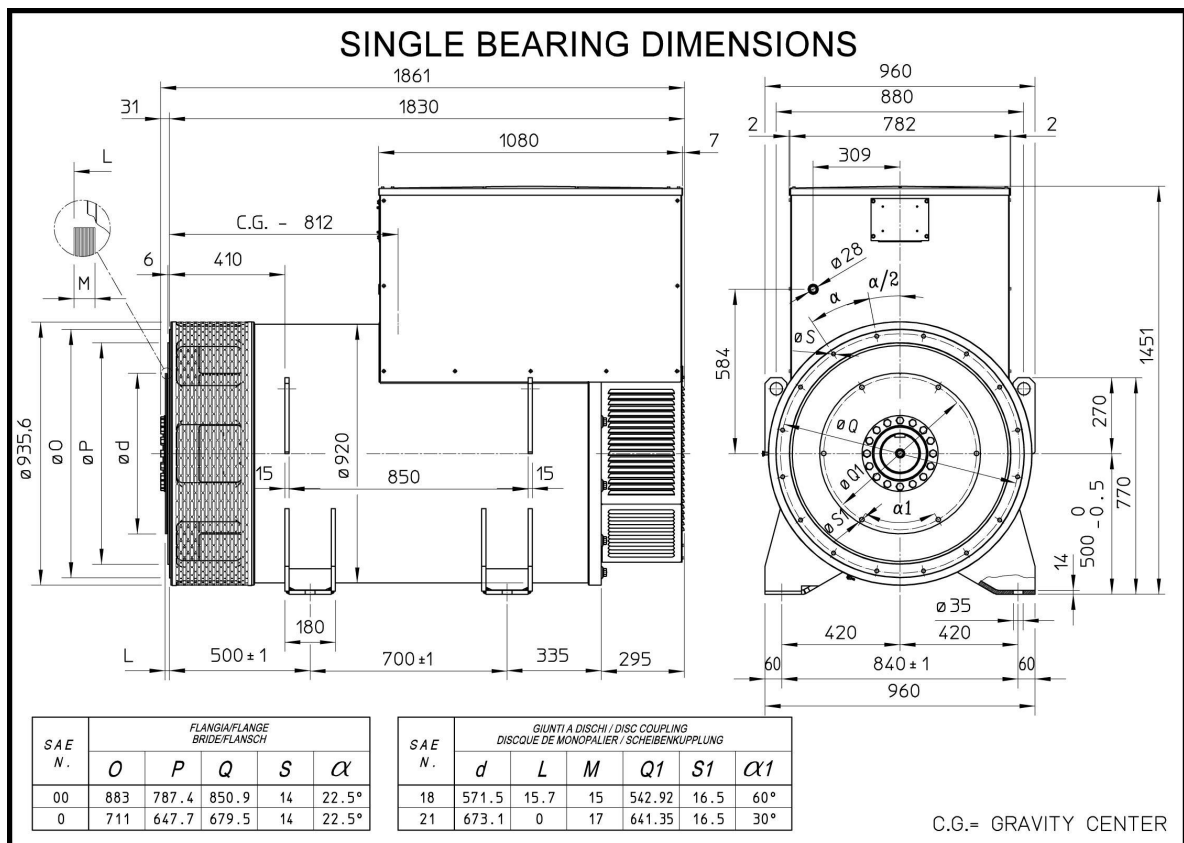
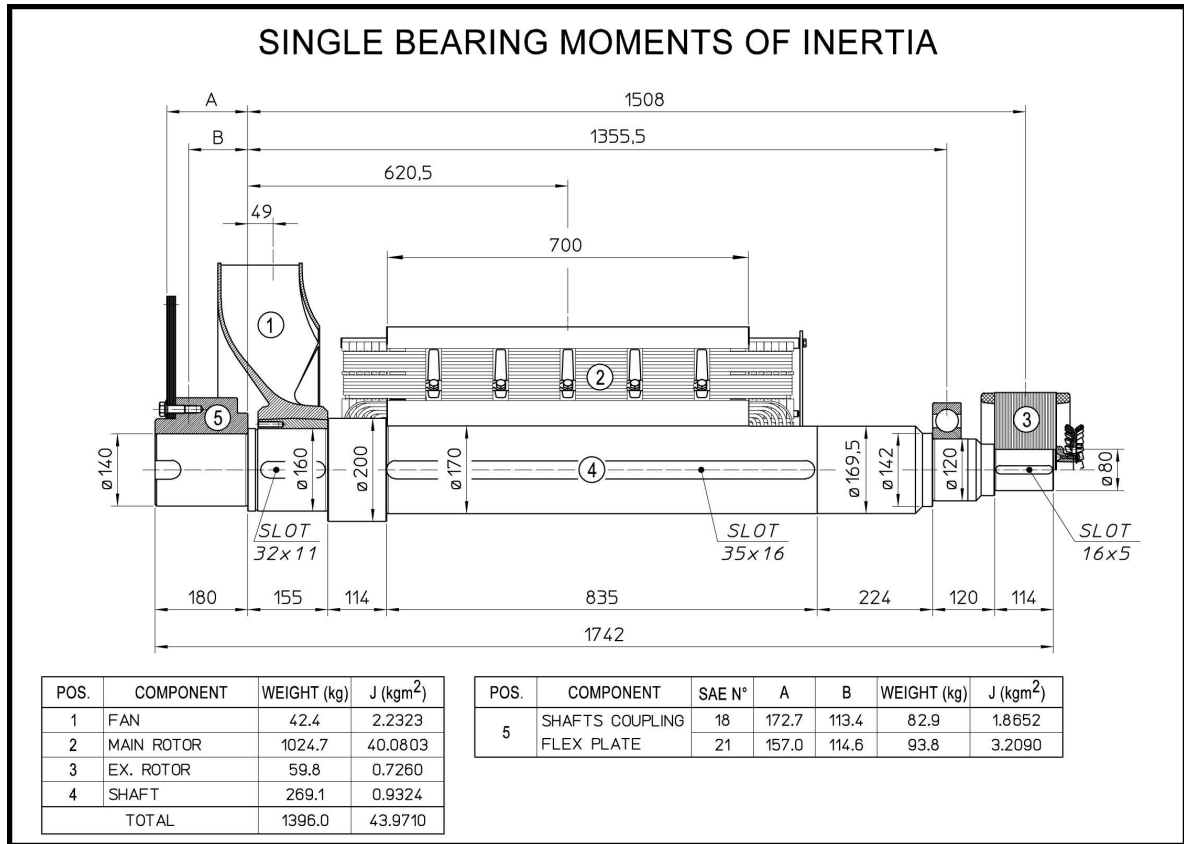

ECO46 1.5L4 A

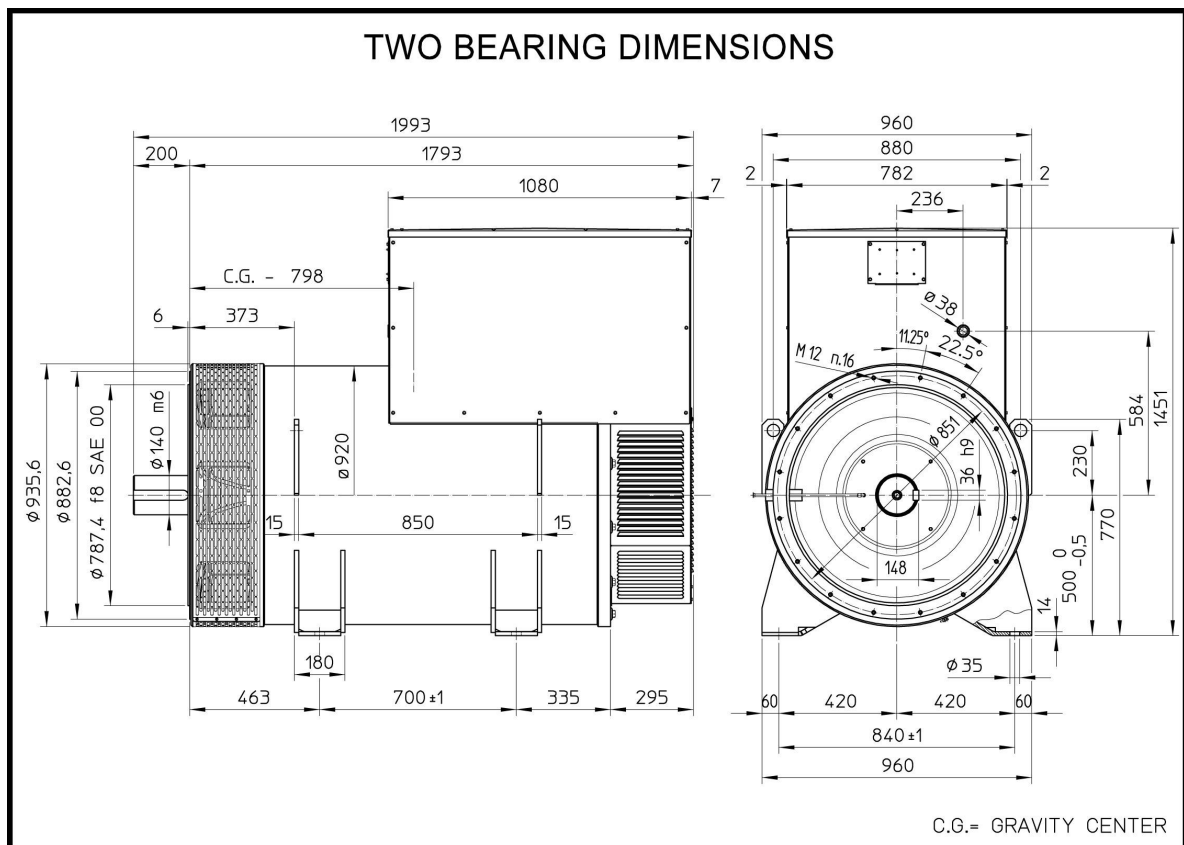
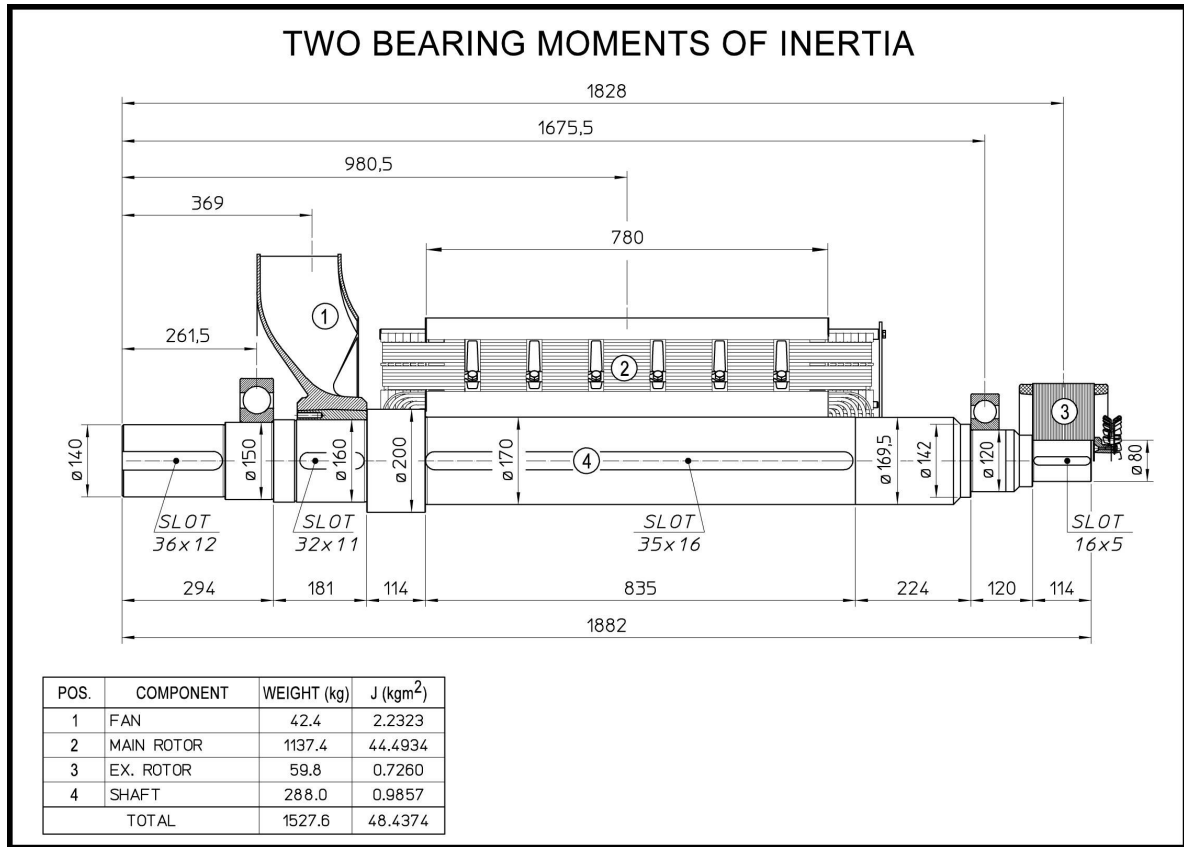

ECO46 1.5L4 A

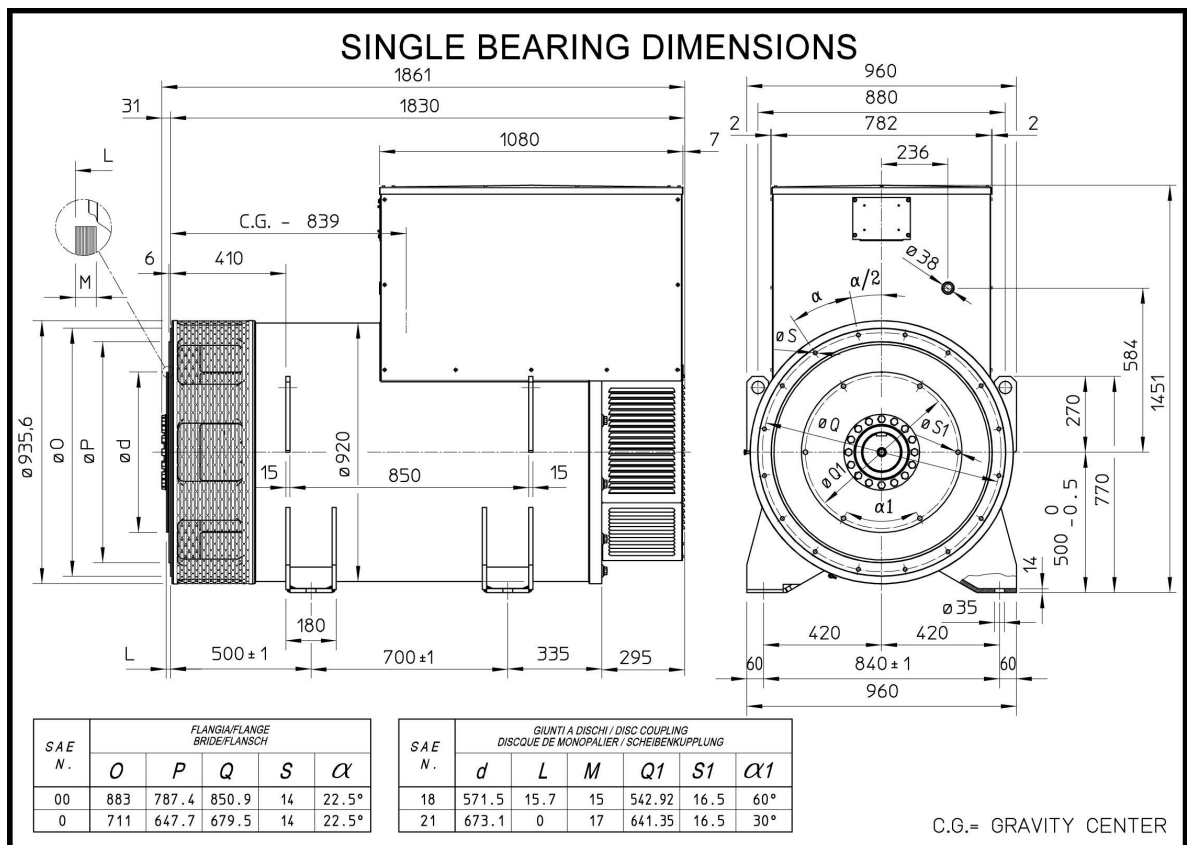
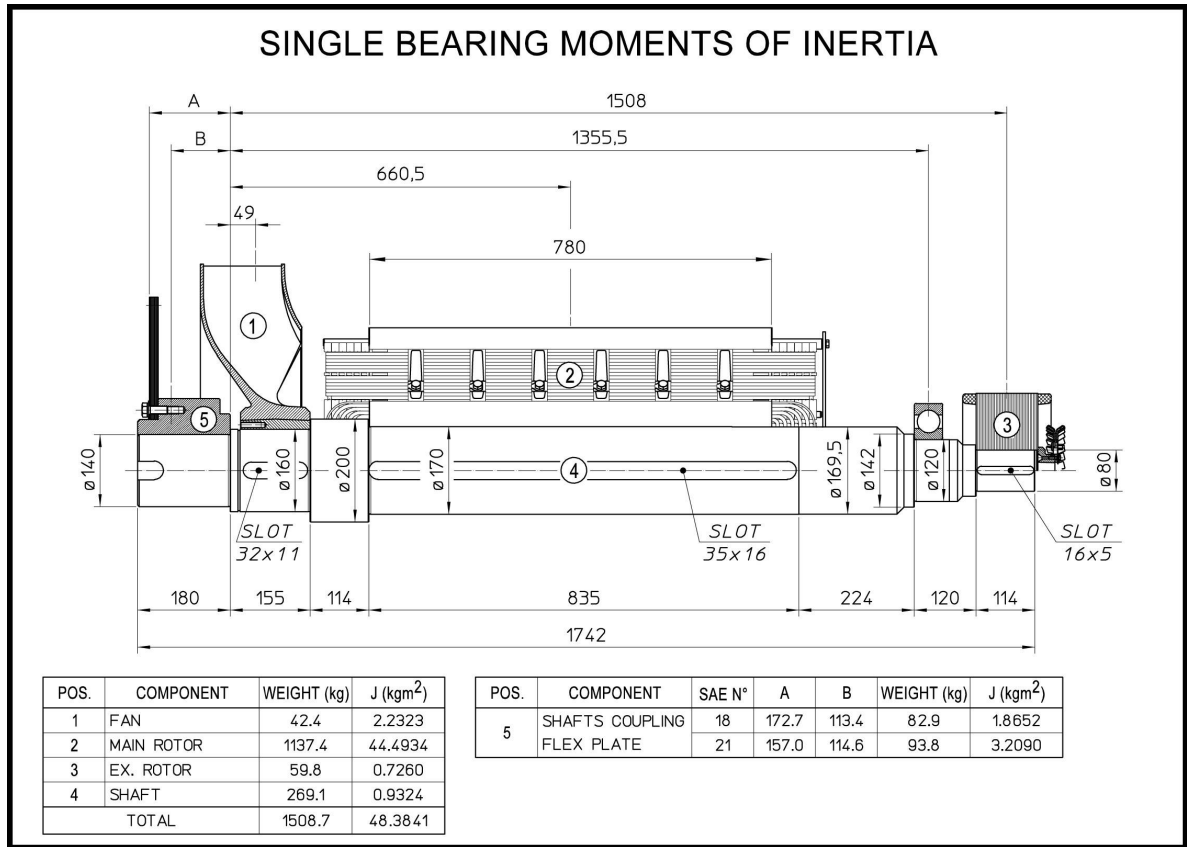

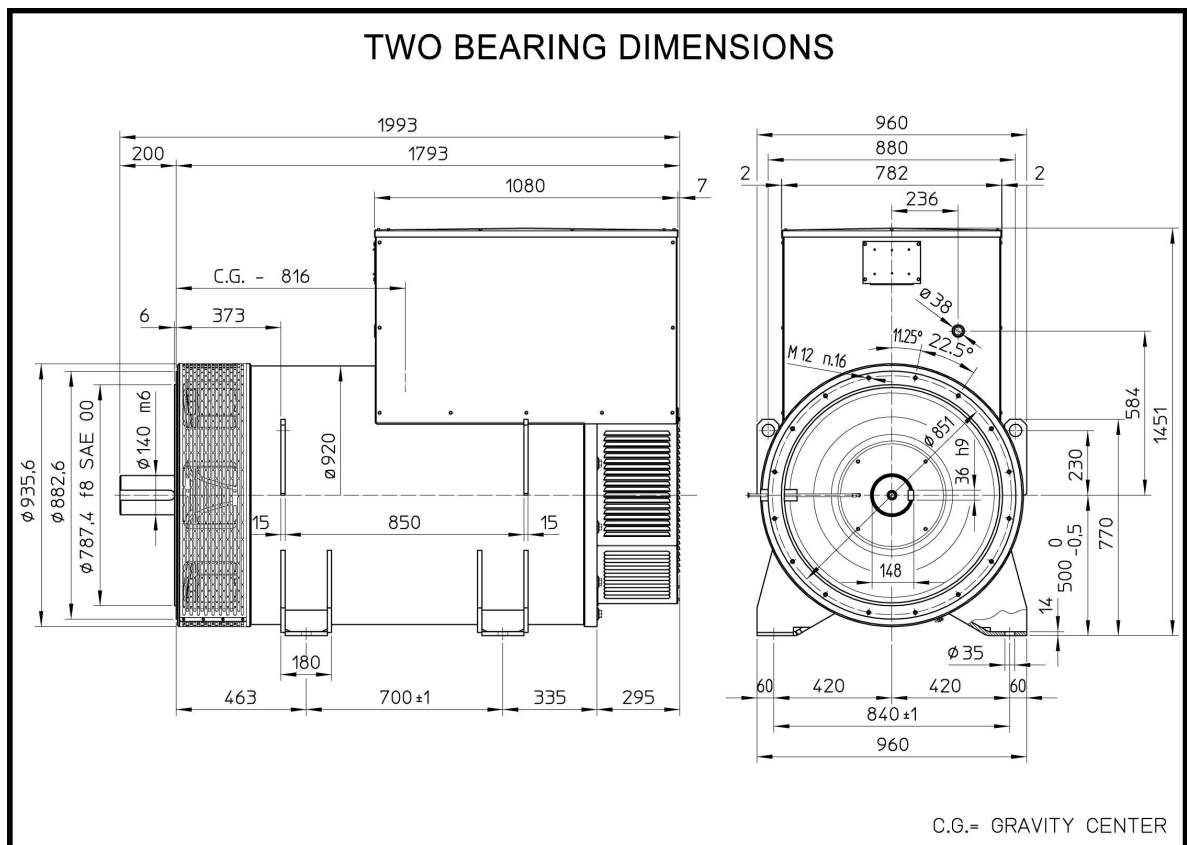
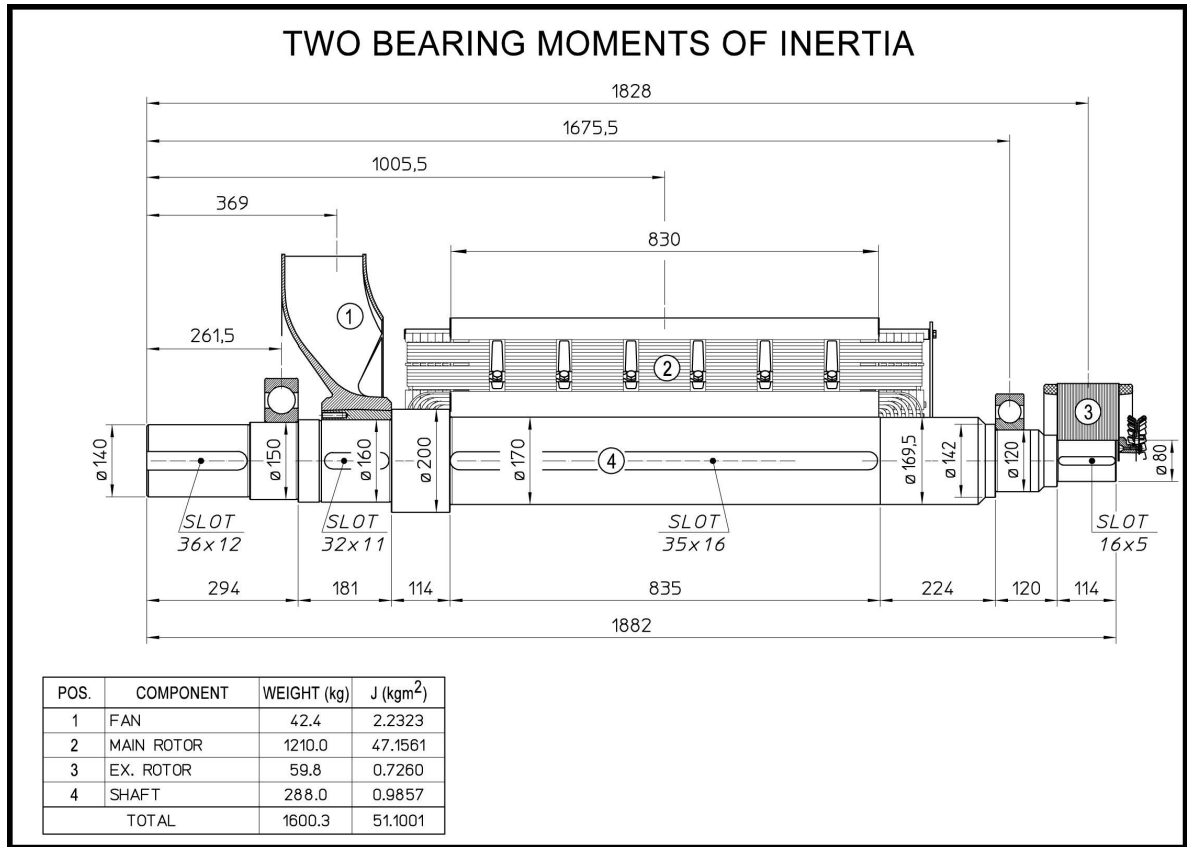

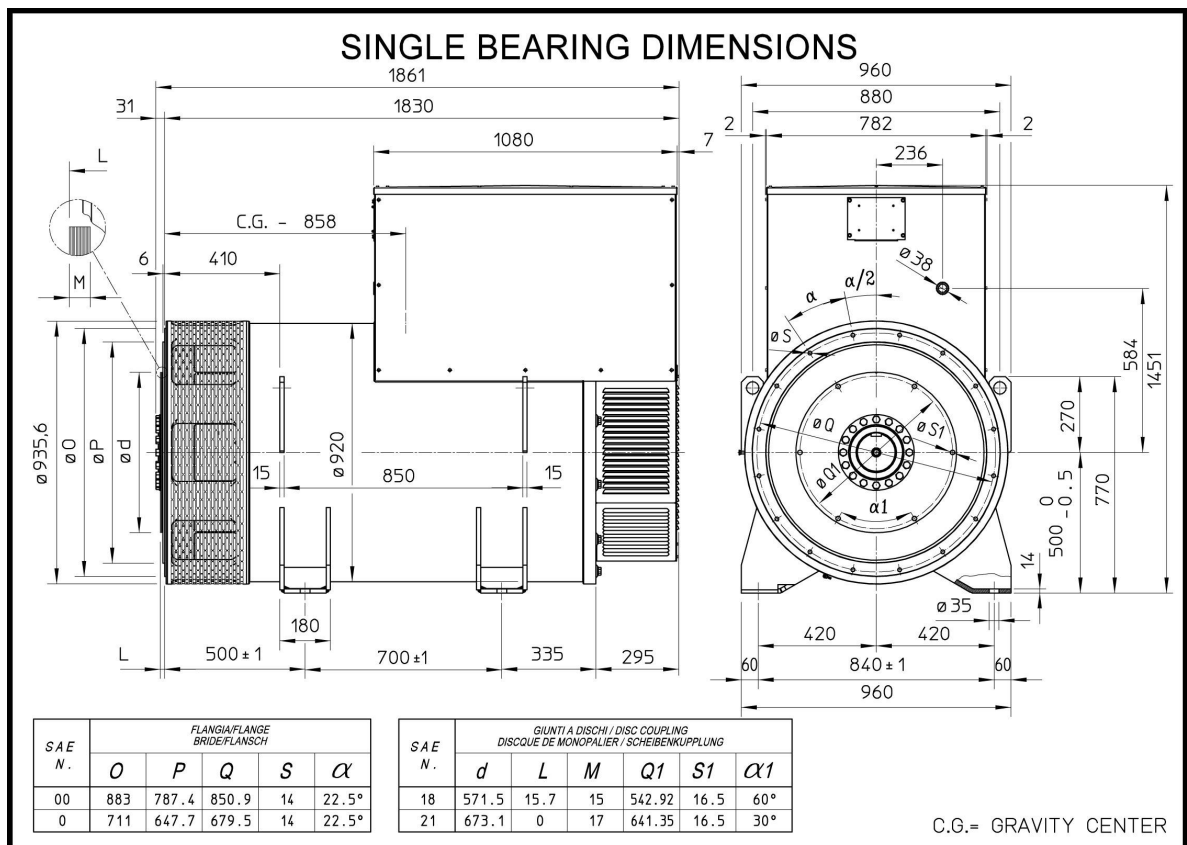
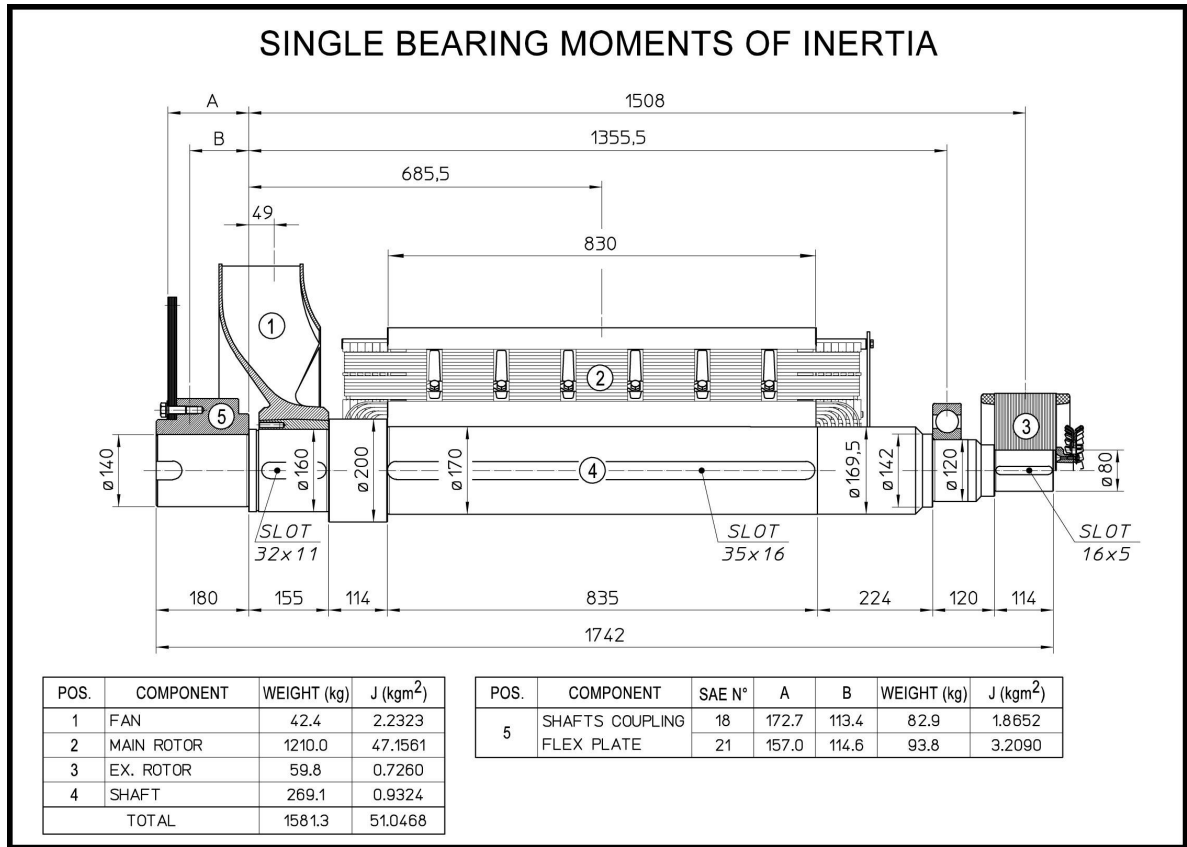

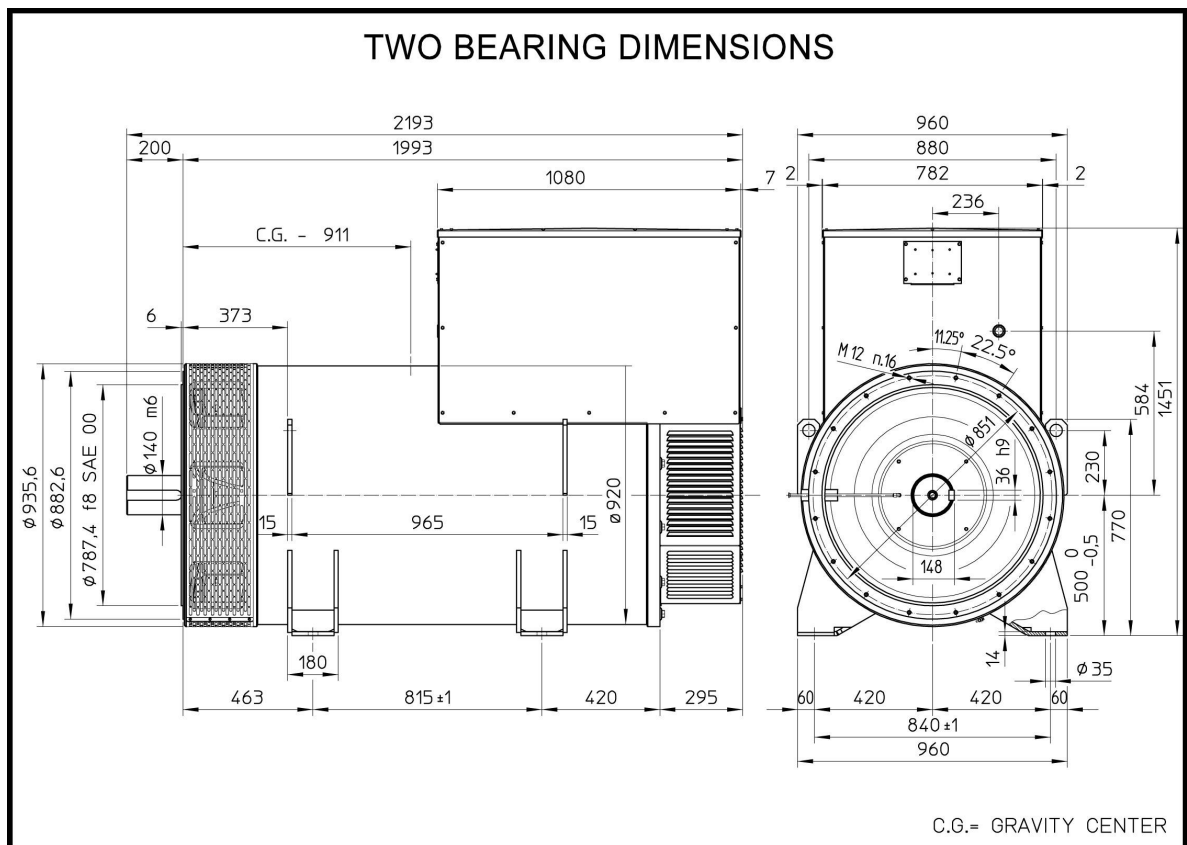
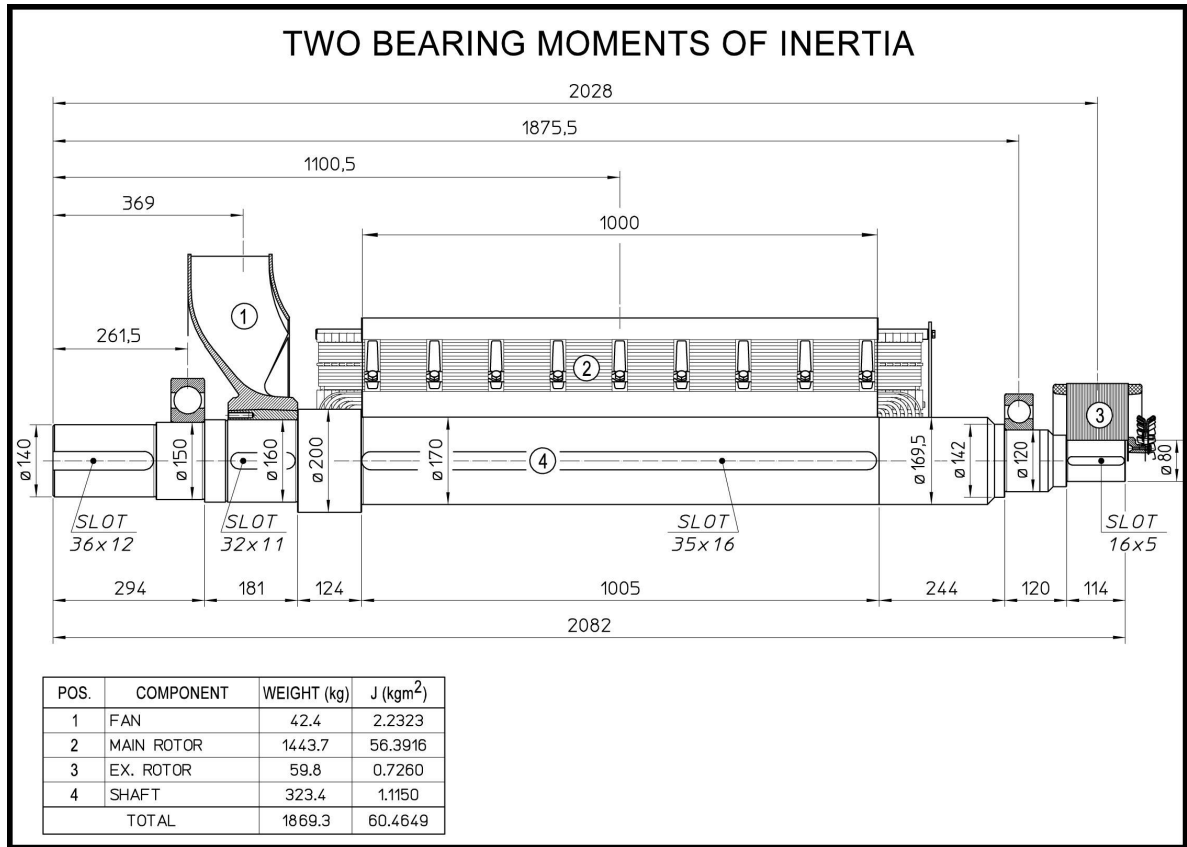

ECO46 VL4 A

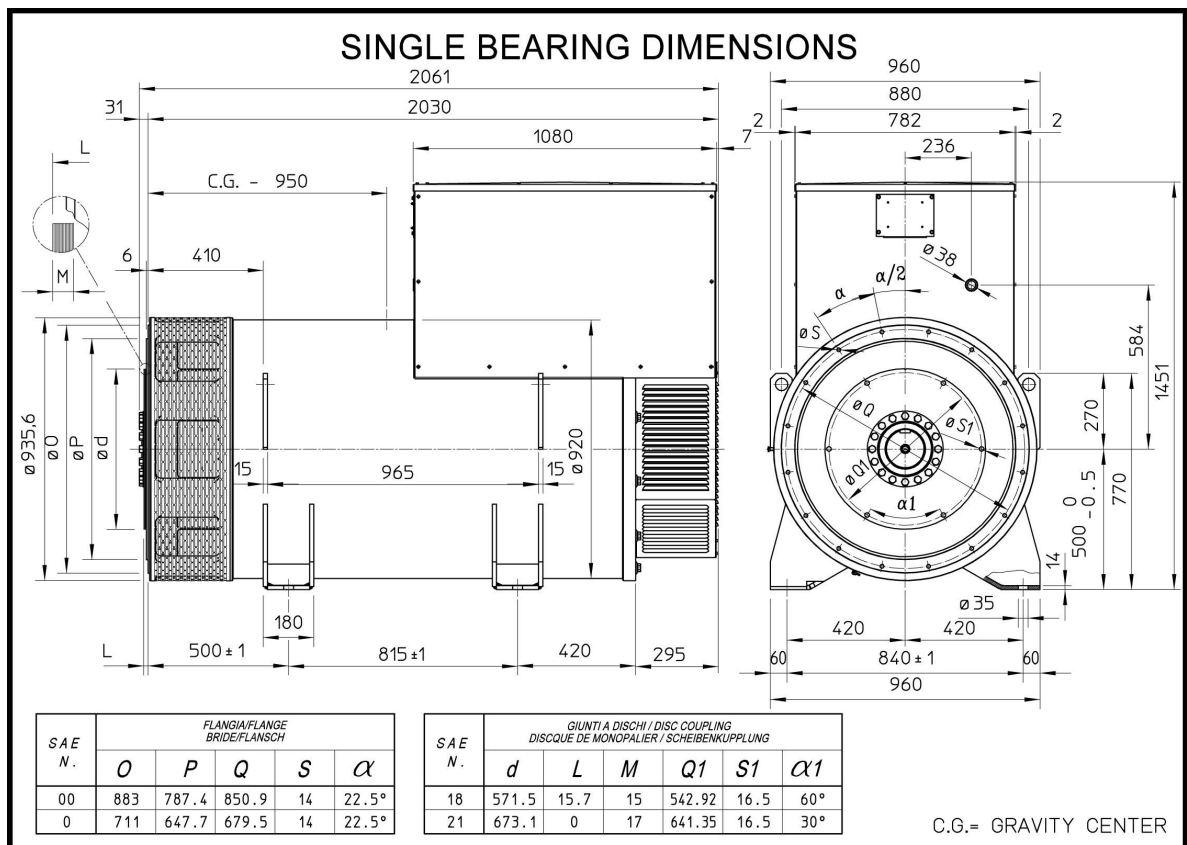
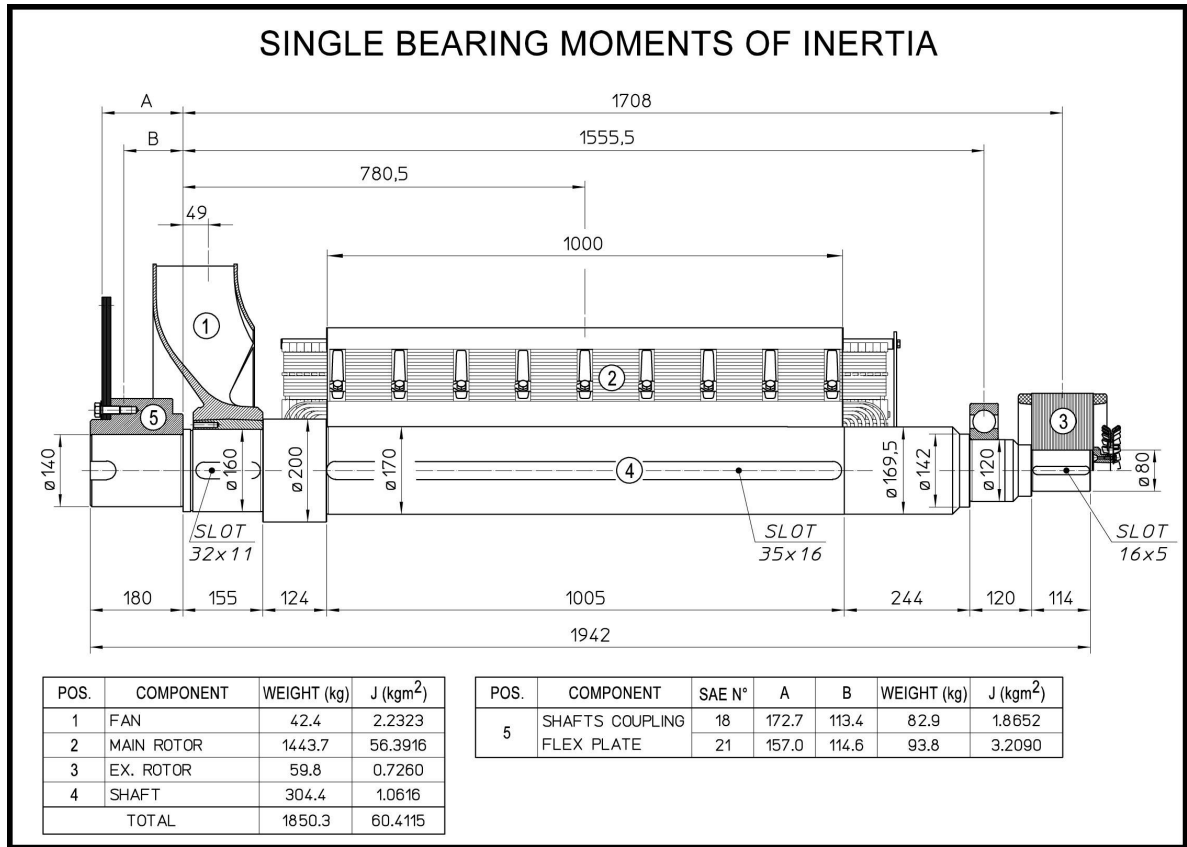

Mecc Alte SpA (HQ)

Via Roma
20 - 36051 Creazzo
Vicenza - ITALY
T: +39 0444 396111
F: +39 0444 396166
E: info@meccalte.it
aftersales@meccalte.it

Mecc Alte Portable

Via Roma
20 - 36051 Creazzo
Vicenza - ITALY
T: +39 0444 396111
F: +39 0444 396166
E: info@meccalte.it
aftersales@meccalte.it

Mecc Alte Power Products srl

Via Melaro
Z - 36075 Montecchio
Maggiore (VI) - ITALY
T: +39 0444 1831295
F: +39 0444 1831306
E: info@meccalte.it
aftersales@meccalte.it

Zanardi Alternatori srl

Via Dei Laghi
48/B - 36077 Altavilla
Vicenza - ITALY
T: +39 0444 370799
F: +39 0444 370330
E: info@zanardialternatori.it

United Kingdom

Mecc Alte U.K. LTD
6 Lands' End Way
Oakham
Rutland LE15 6RF
T: +44 (0) 1572 771160
F: +44 (0) 1572 771161
E: info@meccalte.co.uk
aftersales@meccalte.co.uk

Spain

Mecc Alte España S.A.
C/ Rio Taibilla, 2
Polig. Ind. Los Valeros
03178 Benijofar (Alicante)
T: +34 (0) 96 6702152
F: +34 (0) 96 6700103
E: info@meccalte.es
aftersales@meccalte.es

China

Mecc Alte Alternator Haimen LTD
755 Nanghai East Rd
Jiangsu HEDZ 226100 PRC
T: +86 (0) 513 82325758
F: +86 (0) 513 82325768
E: info@meccalte.cn
aftersales@meccalte.cn

India

Mecc Alte India PVT LTD
Plot NO: 1, Sanaswadi
Talegaon
Dhamdhare Road Taluka:
Shirur, District:
Pune - 412208
Maharashtra, India
T: +91 2137 619600
F: +91 2137 619699
E: info@meccalte.in
aftersales@meccalte.in

U.S.A. and Canada

Mecc Alte Inc.
1229 Adams Drive
McHenry, IL, 60051
T: +1 815 344 0530
F: +1 815 344 0535
E: info@meccalte.us
aftersales@meccalte.us

Germany

Mecc Alte Generatoren GmbH
Ensener Weg 21
D-51149 Köln
T: +49 (0) 2203 503810
F: +49 (0) 2203 503796
E: info@meccalte.de
aftersales@meccalte.de

Australia

Mecc Alte Alternators PTY LTD
10 Duncan Road, PO Box 1046
Dry Creek, 5094, South
Australia
T: +61 (0) 8 8349 8422
F: +61 (0) 8 8349 8455
E: info@meccalte.com.au
aftersales@meccalte.com.au

France

Mecc Alte International S.A.
Z.E.La Gagnerie
16330 ST.Amant de Boixe
T: +33 (0) 545 397562
F: +33 (0) 545 398820
E: info@meccalte.fr
aftersales@meccalte.fr

Far East

Mecc Alte (F.E.) PTE LTD
19 Kian Teck Drive
Singapore 628836
T: +65 62 657122
F: +65 62 653991
E: info@meccalte.com.sg
aftersales@meccalte.com.sg



www.meccalte.com