



Fischer Panda®

Power
wherever
you are™



Marine Generator Manual

Panda 4000s.Neo PMS

Super silent technology

230 V 50 Hz 4 kVA

Panda_4000s.Neo_PMS_eng.R01.1

3.7.17



Current revision status

| | Document |
|-----------------|--------------------------------------|
| Actual: | Panda_4000s.Neo_PMS_eng.R01.1_3.7.17 |
| Replace: | Panda_4000s.Neo_PMS_eng.R01 |

| Revision | Page |
|---------------------------------|------|
| Update Tabelle Motordaten R01.1 | |
| | |
| | |
| | |
| | |
| | |
| | |

Erstellt durch / created by

Fischer Panda GmbH - Leiter Technische Dokumentation

Otto-Hahn-Str. 32-34

33104 Paderborn - Germany

Tel.: +49 (0) 5254-9202-0

email: info@fischerpanda.de

web: www.fischerpanda.de

Copyright

Duplication and change of the manual is permitted only in consultation with the manufacturer!

Fischer Panda GmbH, 33104 Paderborn, reserves all rights regarding text and graphics. Details are given to the best of our knowledge. No liability is accepted for correctness. Technical modifications for improving the product without previous notice may be undertaken without notice. Before installation, it must be ensured that the pictures, diagrams and related material are applicable to the genset supplied. Enquiries must be made in case of doubt.

Inhalt / Contents

| | |
|---|-----------|
| Marine Generator Manual | 1 |
| Current revision status | 2 |
| 1 General Instructions and Regulations | 8 |
| 1.1 Safety first! | 8 |
| 1.2 Tools | 10 |
| 1.3 Manufacturer declaration in accordance with the Machinery Directive 2006/42/EC | 12 |
| 1.4 Customer registration and guarantee | 12 |
| 1.4.1 Technical support | 12 |
| 1.4.2 Caution, important information for start-up! | 12 |
| 1.5 Safety Instructions - Safety First! | 13 |
| 1.5.1 Safe operation | 13 |
| 1.5.2 Observe safety instructions! | 13 |
| 1.5.3 Personal protective clothing (PPE) | 13 |
| 1.5.4 Cleanliness ensures safety | 13 |
| 1.5.5 Safe handling of fuels and lubricants | 14 |
| 1.5.6 Exhaust fumes and fire protection | 14 |
| 1.5.7 Safety precautions against burns and battery explosions | 15 |
| 1.5.8 Protect your hands and body from rotating parts! | 15 |
| 1.5.9 Anti-freeze and disposal of fluids | 15 |
| 1.5.10 Implementation of safety inspections and maintenance | 16 |
| 1.6 Warning and instruction signs | 16 |
| 1.6.1 Special instructions and hazards of generators | 16 |
| 1.6.1.1 Protective conductor and potential equalisation: | 17 |
| 1.6.1.2 Protective conductor for Panda AC generators: | 17 |
| 1.6.1.3 Switch off all loads while working on the generator | 17 |
| 1.6.1.4 Potential equalisation for Panda AGT DC generators | 17 |
| 1.6.1.5 Safety instructions concerning cables | 18 |
| 1.6.2 General safety instructions for handling batteries | 18 |
| 2 In case of Emergency First Aid / Im Notfall - Erste Hilfe | 19 |
| 2.1 WHEN AN ADULT STOPS BREATHING | 20 |
| 3 Basics | 21 |
| 3.1 Intended use of the machine | 21 |
| 3.1.1 Purpose of the manual and description of the definitions trained person/operator/user | 21 |
| 3.1.1.1 Trained persons | 21 |
| 3.1.2 Operator | 21 |
| 3.1.2.1 User | 21 |
| 3.2 Scope of delivery | 22 |
| 3.2.1 Asynchronous Generator: | 22 |
| 3.3 Panda Transport Box | 23 |
| 3.3.1 Bolted Fischer Panda Transport Box | 23 |
| 3.3.2 Fischer Panda Transport Box with metal tab closure | 23 |
| 3.3.3 Opening the MPL sound insulation capsule | 24 |
| 3.3.4 Opening the GFK sound insulation capsule | 25 |
| 3.4 Transport and Loading/Unloading | 25 |
| 3.4.1 Transporting the generator | 25 |
| 3.4.2 Loading/unloading of the generator | 25 |
| 4 Panda 4000s Neo PMS generator | 27 |

Inhalt / Contents

| | | |
|----------|---|-----------|
| 4.1 | Type plate at the generator | 27 |
| 4.2 | Description of the Generator | 28 |
| 4.2.1 | Right Side View | 28 |
| 4.2.2 | Left Side View | 29 |
| 4.2.3 | Front View | 30 |
| 4.2.4 | Back View | 31 |
| 4.3 | Details of function units | 32 |
| 4.3.1 | Control panel | 32 |
| 4.3.2 | Components of the Cooling System | 33 |
| 4.3.3 | Components of the Fuel System | 34 |
| 4.3.4 | Components of the Electrical System | 35 |
| 4.3.5 | Components of the Oil Circuit | 36 |
| 4.3.6 | Sensors and switches for operating surveillance | 36 |
| 4.4 | Operation Instructions - See separate remote control panel manual..... | 38 |
| 4.4.1 | Daily routine checks before starting - See remote control panel manual. | 38 |
| 4.4.2 | Starting Generator - See remote control panel manual. | 38 |
| 4.4.3 | Stopping the Generator - See remote control panel manual. | 38 |
| 5 | Installation Instructions..... | 39 |
| 5.1 | Personal requirements | 39 |
| 5.1.1 | Hazard notes for the installation | 39 |
| 5.2 | Place of installation | 41 |
| 5.2.1 | Preliminary remark | 41 |
| 5.2.2 | Preparing the base - placement | 41 |
| 5.2.3 | Advice for optimal sound insulation | 42 |
| 5.3 | Generator Connections | 42 |
| 5.4 | Installation of the cooling system - raw water | 43 |
| 5.4.1 | General information | 43 |
| 5.4.2 | Installation of the through hull fitting in Yachts - scheme | 43 |
| 5.4.3 | Quality of the raw water sucking in line | 43 |
| 5.4.4 | Generator installation above waterline | 44 |
| 5.4.5 | Generator installation below waterline | 44 |
| 5.4.5.1 | Raw water installation scheme | 45 |
| 5.4.6 | First filling and ventilation of the internal cooling water circuit | 46 |
| 5.4.6.1 | Anti-freeze in the cooling water circuit..... | 47 |
| 5.4.7 | Temperature check for controlling the cooling water circuit | 47 |
| 5.5 | Installation of the water cooled exhaust system | 48 |
| 5.5.1 | Installation of the standard exhaust system | 48 |
| 5.6 | .Installation of the waterlock..... | 48 |
| 5.6.1 | Possible cause for water in the exhaust hose | 49 |
| 5.6.1.1 | Possible cause: exhaust hose | 49 |
| 5.6.1.2 | Possible cause: cooling water hose | 49 |
| 5.6.2 | Installation area of the waterlock | 49 |
| 5.6.3 | The volume of the waterlock | 50 |
| 5.6.3.1 | Ideal position of the waterlock | 50 |
| 5.6.3.2 | Example of the installation of the waterlock off-center and possible effects: ... | 52 |
| 5.7 | Exhaust / water separator | 53 |
| 5.8 | Installation exhaust water separator | 54 |
| 5.9 | Fuel system installation..... | 55 |

Inhalt / Contents

| | | |
|----------|---|-----------|
| 5.9.1 | The following items need to be installed: | 55 |
| 5.9.2 | Connection of the fuel lines at the tank | 56 |
| 5.9.3 | Position of the pre-filter with water separator | 57 |
| 5.10 | Ventilating the fuel system | 58 |
| 5.11 | Generator DC system installation | 58 |
| 5.11.1 | Connection of the starter battery block | 58 |
| 5.12 | Generator AC System Installation | 61 |
| 5.12.1 | Power source selector | 62 |
| 5.13 | Checking and filling of the oil circuit..... | 63 |
| 5.14 | Isolation test..... | 63 |
| 5.15 | Initial operation | 63 |
| 6 | Maintenance Instructions..... | 65 |
| 6.1 | Personal requirements..... | 65 |
| 6.2 | Personal requirements..... | 65 |
| 6.3 | Hazard notes for the maintenance and failure..... | 65 |
| 6.4 | Environmental protection | 67 |
| 6.5 | General maintenance instructions | 67 |
| 6.5.1 | Maintenance parts | 67 |
| 6.5.2 | Checks before each start | 68 |
| 6.6 | Maintenance interval..... | 68 |
| 6.6.1 | Check of Hoses and Rubber Parts in the sound insulated capsule | 68 |
| 6.7 | Oil Change Intervals | 68 |
| 6.8 | Checking oil-level..... | 68 |
| 6.8.1 | Refilling oil | 69 |
| 6.8.2 | After the oil level check and refilling the oil | 70 |
| 6.9 | Replacement of engine oil and engine oil filter | 70 |
| 6.9.1 | After the oil change | 72 |
| 6.10 | Verifying the starter battery and (if necessary) the battery bank | 72 |
| 6.10.1 | Battery | 72 |
| 6.10.1.1 | Check battery and cable connections | 72 |
| 6.11 | Checking the water separator in the fuel supply | 73 |
| 6.11.1 | Exchange of the Fuel Filter | 73 |
| 6.11.2 | De-aerating the fuel system | 73 |
| 6.11.3 | Replacement of the air filter | 74 |
| 6.12 | De-aerating of the coolant circuit / freshwater | 75 |
| 6.13 | The raw water circuit..... | 75 |
| 6.13.1 | Clean raw water filter | 75 |
| 6.13.2 | Causes with frequent impeller waste | 75 |
| 6.13.3 | Replacement of the impeller | 76 |
| 7 | Generator Tables | 79 |
| 7.1 | Diameter of conduits..... | 79 |
| 7.2 | Technical Data..... | 79 |
| 7.3 | Types of coil | 80 |
| 7.4 | Engine oil..... | 80 |

Inhalt / Contents

| | | |
|----------|---|-----------|
| 7.4.1 | Engine oil classification | 80 |
| 7.5 | Fuel | 80 |
| 7.6 | Coolant specifications | 80 |
| 7.6.1 | Coolant mixture ratio | 81 |
| 8 | Remote Control Panel P4 Control | 83 |
| 8.1 | Remote control panel | 83 |
| 8.1.1 | Cleaning and Replacing parts at the generator | 84 |
| 8.2 | Front side | 85 |
| 8.2.1 | Back side | 85 |
| 8.3 | Operation manual | 86 |
| 8.3.1 | Preliminary remarks | 86 |
| 8.3.2 | Override function | 86 |
| 8.3.3 | Daily routine checks before starting | 86 |
| 8.3.4 | Starting the generator | 87 |
| 8.3.5 | Stopping the generator | 87 |
| 8.4 | Installation of the panel | 88 |
| 8.4.1 | Connection of the remote control panel | 88 |
| 8.5 | Jumper configuration | 90 |
| 8.5.1 | Jumper configuration for the input | 90 |
| 8.5.1.1 | Jumper J101-J103..... | 90 |
| 8.5.2 | Jumper for configuration of the „Override“ time | 91 |
| 8.6 | Maximum ratings..... | 91 |

Dear Customer,

Thank you for purchasing a Fischer Panda Generator and choosing Fischer Panda as your partner for mobile power on board. With your generator, you now have the means to produce your own power – wherever you are - and experience even greater independence. Not only do you have a Fischer Panda generator on board, you also have worldwide support from the Fischer Panda Team. Please take the time to read this and find how we can support you further.

Installation Approval and Warranty

Every generator has a worldwide warranty. You can apply for this warranty through your dealer when the installation is approved. If you have purchased an extended warranty, please ensure that it is kept in a safe place and that the dealer has your current address. Consult your dealer about warranty options especially if you have purchased a used generator. He will be able to advise about authorised Fischer Panda Services worldwide.

Service and Support

To ensure that your generator operates reliably, regular maintenance checks and tasks as specified in this manual must be carried out. Fischer Panda can supply Service Kits which are ideal for regular servicing tasks. We only supply the highest quality components which are guaranteed to be the RIGHT parts for your generator. Service “Plus” Kits are also available and ideal for longer trips where more than one service interval may be required.

If you require assistance – please contact your Fischer Panda Dealer. Please do not attempt to undertake any repair work yourself, as this may affect your generator warranty. Your dealer will also be able to assist in finding your nearest Fischer Panda service station. Your nearest service station can also be found in our Global Service Network which can be downloaded from our homepage.

Product Registration

Please take the time to register your Fischer Panda Generator on our website at

<http://www.fischerpanda.de/mypanda>

By registering, you will ensure that you will be kept up to date on any technical upgrades or specific information on the operation or servicing of your generator. We can even let you know about new Fischer Panda products – especially helpful if you are planning to upgrade or expand your installation at a later date.

Fischer Panda Quality - Tried and Tested

DIN-certified according DIN ISO 9001

Thank you for purchasing a Fischer Panda Generator.

Your Fischer Panda Team

1. General Instructions and Regulations

1.1 Safety first!

These symbols are used throughout this manual and on labels on the machine itself to warn of the possibility of personal injury or lethal danger during certain maintenance work or operations. Read these instructions carefully.

Can cause acute or chronic health impairments or death even in very small quantities if inhaled, swallowed, or absorbed through the skin.

WARNING: Hazardous materials



This warning symbol draws attention to special warnings, instructions or procedures which, if not strictly observed, may result in damage or destruction of equipment.

WARNING: Important information!



Warning of materials that may ignite in the presence of an ignition source (cigarettes, hot surfaces, sparks, etc.).

WARNING: Fire hazard



In the environment described / during the work specified, smoking is prohibited.

PROHIBITED: No smoking



Fire and naked light are ignition sources that must be avoided.

PROHIBITED: No fire or naked light



The equipment shall not be activated or started up while work is in progress.

PROHIBITED: Do not activate/start up



Touching of the corresponding parts and systems is prohibited.

PROHIBITED: Do not touch



Danger for life! Working at a running generator can result in severe personal injury.

DANGER: Automatic start-up



The generator can be equipped with a automatic start device. This means, an external signal may trigger an automatic start-up. To avoid an unexpected starting of the generator, the starter battery must be disconnected before working at the generator.

This danger symbol refers to the danger of electric shock and draws attention to special warnings, instructions or procedures which, if not strictly observed, may result in severe personal injury or loss of life due to electric shock.

WARNING: Hazardous electric voltage



General warning of a hazard area

WARNING: General warning



Can cause acute or chronic health impairments or death even in very small quantities if inhaled or ingested.

WARNING: Danger due to inhalation and/or ingestion



Warning of live parts that may cause electric shock upon contact. Especially dangerous for persons with heart problems or pacemakers.

WARNING: Risk of electric shock upon contact



Danger of injury due to being pulled into equipment. Bruising and torn off body parts possible. Risk of being pulled in when touching with body part, loose-fitting clothing, scarf, tie, etc.

WARNING: Danger due to rotating parts



Warning of substances that may cause an explosion under certain conditions, e.g. presence of heat or ignition sources.

WARNING: Explosion hazard



Warning of hot surfaces and liquids. Burn/scalding hazard.

WARNING: Hot surface



Warning of substances that cause chemical burns upon contact. These substances can act as contaminants if introduced into the body.

WARNING: Danger due to corrosive substances, potential contamination of person



When the system is opened, the pressure can be relieved abruptly and expel hot gases and fluids. Risk of injury due to parts flying about, burn hazard due to liquids and gases.

WARNING: System may be pressurised!



Warning of hearing damages.

WARNING: Hearing damage



Warning of magnetic field.

WARNING: Magnetic field



Warning of overpressure.

WARNING: Overpressure



Wearing the applicable snugly fitting protective clothing provides protection from hazards and can prevent damage to your health.

MANDATORY INSTRUCTION: Wear snugly fitting protective clothing (PPE).



Wearing hearing protection provides protection from acute and gradual hearing loss.

MANDATORY INSTRUCTION: Wear hearing protection (PPE).



Wearing safety goggles protects the eyes from damage. Optical spectacles are not a replacement for the corresponding safety goggles.

MANDATORY INSTRUCTION: Wear safety goggles (PPE).



Wearing protective gloves provides the hands from hazards like friction, graze, punctures or deep cuts and protects them from contact with hot surfaces.

MANDATORY INSTRUCTION: Wear protective gloves (PPE).



Compliance with the instructions in the manual can avert danger and prevent accidents. This will protect you and the generator.

MANDATORY INSTRUCTION: Observe the instructions in the manual.







Environmental protection saves our living environment. For you and for your children.





MANDATORY INSTRUCTION: Comply with environmental protection requirements.



1.2 Tools

These symbols are used throughout this manual to show which tool must be used for maintenance or installation.

| | |
|---|--|
|  | Spanners W.A.F X = width across flats of X mm |
|  | Hook wrench for oil filter |
|  | Screw driver, for slotted head screws and for Phillips head screws |
|  | Multimeter, multimeter with capacitor measuring unit |

| | |
|---|---|
|  | <p>Socket wrench set</p> |
|  | <p>Hexagon socket wrench set</p> |
|  | <p>Clamp-on ammeter (DC for synchronous generators; AC for asynchronous generators)</p> |
|  | <p>Torque wrench</p> |

1.3 Manufacturer declaration in accordance with the Machinery Directive 2006/42/EC

Manufacturer declaration in accordance with the Machinery Directive 2006/42/EC

The generator was designed in such a way that all assemblies correspond with the CE guidelines. If Machinery Directive 2006/42/EC is applied, then it is forbidden to start the generator until it has been ascertained that the system into which the generator is to be integrated also complies with the Machinery Directive 2006/42/EC. This includes the exhaust system, cooling system and electrical installations.

The evaluation of "protection against contact" must be carried out when installed, in conjunction with the respective system. This also includes correct electrical connections, a safe ground wire connection, foreign body and humidity protection, protection against moisture due to excessive condensation, as well as overheating through appropriate and inappropriate use of the equipment in its installed state. The responsibility for implementing these measures lies with those who undertake the installation of the generator in the final system.

1.4 Customer registration and guarantee

Use the advantages of registering your product:

- you will receive a Guarantee Certificate after approval of your installation data
- you will receive extended product information that may be relevant to safety.
- You will receive free upgrades as necessary.

Additional advantages:

Based on your complete data record, Fischer Panda technicians can provide you with fast assistance, since 90 % of the disturbances result from defects in the periphery.

Problems due to installation errors can be recognized in advance.

1.4.1 Technical support

Technical Support via the Internet: info@fischerpanda.de

1.4.2 Caution, important information for start-up!

1. The commissioning log shall be filled in immediately after initial operation and shall be confirmed by signature.
2. The commissioning log must be received by Fischer Panda GmbH at Paderborn within 4 weeks of initial operation.
3. After receiving the commissioning log, Fischer Panda will make out the official guarantee certificate and send it to the customer.
4. If warranty claims are made, the document with the guarantee certification must be submitted.

If the above requirements are not or only partly fulfilled, the warranty claim shall become void.

1.5 Safety Instructions - Safety First!

1.5.1 Safe operation

Careful handling of the equipment is the best insurance against an accident. Read the manual diligently, and make sure you understand it before starting up the equipment. All operators, regardless of their experience level, shall read this manual and additional pertinent manuals before commissioning the equipment or installing an attachment. The owner shall be responsible for ensuring that all operators receive this information and are instructed on safe handling practices.



1.5.2 Observe safety instructions!

Read and understand this manual and the safety instructions on the generator before trying to start up and operate the generator. Learn the operating practices and ensure work safety. Familiarise yourself with the equipment and its limits. Keep the generator in good condition.

1.5.3 Personal protective clothing (PPE)

For maintenance and repair work on the equipment, **do not** wear loose, torn, or ill-fitting clothing that may catch on protruding parts or come into contact with pulleys, cooling disks, or other rotating parts, which can cause severe injury.



Wear appropriate safety and protective clothing during work.

Do not operate the generator while under the influence of alcohol, medications, or drugs.



Do not wear head phones or ear buds while operating, servicing, or repairing the equipment.



1.5.4 Cleanliness ensures safety

Keep the generator and its environment clean.

Before cleaning the generator, shut down the equipment and secure it against accidental start-up. Keep the generator free from dirt, grease, and waste. Store flammable liquids in suitable containers only and ensure adequate distance to the generator. Check the lines regularly for leakage and eliminate leaks immediately as applicable.



1.5.5 Safe handling of fuels and lubricants

Keep fuels and lubricants away from naked fire.

Before filling up the tank and/or applying lubricant, always shut down the generator and secure it against accidental start-up.



Do not smoke and avoid naked flame and sparking near fuels and the generator. Fuel is highly flammable and may explode under certain conditions.

Refuel in well-ventilated open spaces only. If fuel/lubricant was spilled, eliminate fluids immediately.

Do not mix diesel fuel with petrol or alcohol. Such a mixture can cause fire and will damage the generator.



Use only approved fuel containers and tank systems. Old bottles and canisters are not adequate.

1.5.6 Exhaust fumes and fire protection

Engine fumes can be hazardous to your health if they accumulate. Ensure that the generator exhaust fumes are vented appropriately (leak-proof system), and that an adequate fresh air supply is available for the generator and the operator (forced ventilation).



Check the system regularly for leakage and eliminate leaks as applicable.

Exhaust gases and parts containing such fumes are very hot; they may cause burns under certain circumstances. Always keep flammable parts away from the generator and the exhaust system.

To prevent fire, ensure that electrical connections are not short-circuited. Check regularly that all lines and cables are in good condition and that there is no chafing. Bare wires, open chafing spots, frayed insulation, and loose cable connections can cause dangerous electric shocks, short-circuit, and fire.



The generator shall be integrated in the existing fire safety system by the operating company.

CALIFORNIA

Proposition 65 Warning

Diesel engine exhaust and some of its constituents are known to the State of California to cause cancer, birth defects, and other reproductive harm.



1.5.7 Safety precautions against burns and battery explosions

The generator and its cooling agents and lubricants as well as the fuel can get hot while the generator is operated. Use caution around hot components such as parts containing exhaust fumes, radiator, hoses, and engine block during operation and after the generator was shut down.



The cooling system may be pressurised. Open the cooling system only after letting the engine and the coolant cool down. Wear appropriate protective clothing (e.g. safety goggles, gloves).



Prior to operation, ensure that the cooling system is sealed and that all hose clamps are tightened.

The battery represents an explosion hazard, this applies both to the starter battery and the battery bank of the AGT generators. While batteries are being charged, a hydrogen-oxygen mixture is generated, which is highly explosive (electrolytic gas).



Do not use or charge batteries if the fluid level is below the MINIMUM marking. The life span of the battery is significantly reduced, and the risk of explosion increases. Refill to a fluid level between maximum and minimum level without delay.

Especially during charging, keep sparks and naked fire away from the batteries. Ensure that the battery terminals are tightly connected and not corroded to avoid sparking. Use an appropriate terminal grease.



Check the charge level with an adequate voltmeter or acid siphon. Contact of a metal object across the terminals will result in short-circuiting, battery damage, and high explosion risk.

Do not charge frozen batteries. Heat the batteries to +16 °C (61 °F) prior to charging.

1.5.8 Protect your hands and body from rotating parts!

Always keep the capsule closed while operating the generator.

To check the V-belt tension, always shut down the generator.

Keep your hands and body away from rotating parts such as V-belt, fans, pulleys, and flywheel. Contact can cause severe injury.



Do not run the engine without the safety devices in place. Prior to start-up, mount all safety devices securely and check for proper attachment and function.

1.5.9 Anti-freeze and disposal of fluids

Anti-freeze contains toxic substances. To prevent injury, wear rubber gloves and wash off any anti-freeze immediately in case of skin contact. Do not mix different anti-freeze agents. The mixture may cause a chemical reaction generating harmful substances. Use only anti-freeze that was approved by Fischer Panda.



Protect the environment. Collect drained fluids (lubricants, anti-freeze, fuel), and dispose of them properly. Observe the local regulations for the respective country. Ensure that no fluids (not even very small quantities) can drain into the soil, sewers, or bodies of water.



1.5.10 Implementation of safety inspections and maintenance

Disconnect the battery from the engine before performing service work. Affix a sign to the control panel - both the main and the corresponding slave panel - with the instruction "DO NOT START UP - MAINTENANCE IN PROGRESS" to prevent unintentional start-up.



To prevent sparking due to accidental short-circuiting, always remove the earthing cable (-) first and reconnect it last. Do not start work until the generator and all fluids and exhaust system parts have cooled down.

Use only suitable tooling and appliances and familiarise yourself with their functions to prevent secondary damage and/or injury.



Always keep a fire extinguisher and a first aid box handy while performing maintenance work.

1.6 Warning and instruction signs

Keep warning and instruction signs clean and legible.

Clean the signs with water and soap and dry them with a soft cloth.

Immediately replace damaged or missing warning and instruction signs. This also applies to the installation of spare parts.

1.6.1 Special instructions and hazards of generators

The electrical installations may only be carried out by trained and qualified personnel!



The generator must not be operated with the cover removed.

If the generator is being installed without a sound insulation capsule, it must be ensured that all rotating parts (belt-pulley, belts etc.) are covered and protected so that there is no danger to life and body!



If a sound insulation covering will be produced at the place of installation, then easily visible signs must show that the generator must only be switched on while the capsule is closed.



All servicing, maintenance, or repair work may only be carried out when the motor is not running.

Electrical voltages above 50 volts are always dangerous to life. The rules of the respective regional authority must be adhered to during installation. For safety reasons, only an electrician may carry out the installation of the electrical connections of the generator.

1.6.1.1 Protective conductor and potential equalisation:

Electric voltage above 50 V may be life-threatening. For this reason systems are grounded with a protective conductor. In connection with a RCD the current supply will be disconnected in case of a failure.

Appropriate safety precautions like the RCD and corresponding fuses have to be provided by the customer to guarantee a safe operation of the generator.

1.6.1.2 Protective conductor for Panda AC generators:

The generator is „earthed“ as a standard (centre and ground are interconnected in the generator terminal box by a shunt). This is a basic first-level safety measure, which offers protection as long as no other measures are installed. Above all, it is designed for delivery and a possible test run.



This „neutralisation“ (Protective Earthing Neutral - PEN) is only effective if all parts of the electrical system are jointly „earthed“ to a common potential. The shunt can be removed if this is necessary for technical reasons and another protective system has been set up instead.

While the generator is being operated, the full voltage is applied to the AC control box, as well. Therefore, it is essential to ensure that the control box is closed and secured against touch while the generator is running.



The battery must always be disconnected if work on the generator or electrical system is to be carried out, so that the generator cannot be started up unintentionally.

1.6.1.3 Switch off all loads while working on the generator

All loads must be disconnected prior to working on the generator to avoid damage to the devices. In addition, the semiconductor relays in the AC control box must be disconnected in order to avoid the booster capacitors being activated during set-up. The negative terminal of the battery must be disconnected.

Capacitors are required to run the generator. These have two varying functions:

- A) The working capacitors
- B) The booster capacitors

Both groups are located in a separate AC control box.

Capacitors store electrical energy. High voltages may remain across the capacitor contacts even after they have been disconnected from the mains. As a safety precaution, do not touch the contacts. If the capacitors must be replaced or inspected, the contacts shall be short-circuited by connecting an electrical conductor to discharge potentially remaining potential differences.

If the generator is switched off normally, the working capacitors are automatically discharged via the winding of the generator. The booster capacitors are discharged by means of internal discharge resistors.

For safety reasons, all capacitors must be discharged through short-circuiting before work is carried out on the AC control box.

1.6.1.4 Potential equalisation for Panda AGT DC generators

For further information specific to your generator, see the chapter installation.

1.6.1.5 Safety instructions concerning cables

Cable types

It is recommended to use cables that are in compliance with the standard UL 1426 (BC-5W2) with type 3 (ABYC section E-11).

Cable cross-section







The cable shall be selected taking into account the amperage, cable type, and conductor length (from the positive power source connection to the electrical device and back to the negative power source connection).

Cable installation

It is recommended to install a self-draining cable conduit classified as V-2 or higher in compliance with UL 94 in the area of the cable guide inside the capsule. It must be ensured that the cable guide is not routed along hot surfaces such as the exhaust manifold or the engine oil drain screw but instead is installed free from any influence due to friction and crushing.

1.6.2 General safety instructions for handling batteries

These instructions shall apply in addition to the instructions of the battery manufacturer:



- While you are working on the batteries, a second person should be within earshot to help you if necessary. 
- Keep water and soap ready in case battery acid is burning your skin.
- Wear eye protection and protective clothing. Do not touch your eyes while handling batteries.
- If you have acid splashes on the skin or clothing, wash them out with lots of water and soap.
- If acid sprays into your eyes, immediately flush them with clean water until no more burning is felt. Immediately seek medical assistance. 
- Do not smoke near the batteries. Avoid naked fire. The area around batteries is a potentially explosive atmosphere.
- Ensure that no tools are dropped on the battery terminals; cover them as necessary.
- Do not wear jewellery or watches on your arms during installation that might short-circuit the battery. Otherwise, there is a risk of skin burns. 
- Protect all battery contacts against accidental contact.
- For battery banks: Use only deep cycle batteries. Starter batteries are not suitable. Lead-acid gel batteries are recommended. They are maintenance-free, cycle stable, and do not release gases. 
- Never charge a frozen battery.
- Avoid battery short-circuits.
- Ensure proper ventilation of the battery to vent gases that may be released.
- Battery connection terminals must be checked for proper seating before operation. 
- Battery connection cables shall be installed with utmost care and shall be checked for excessive heating under load. Check the battery near vibrating components regularly for chafing and insulation defects. 

ATTENTION! For battery charger generators (Fischer Panda AGT-DC)!

Prior to installation, verify that the voltage of the battery bank complies with the output voltage of the generator. 

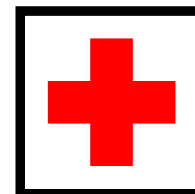
2. In case of Emergency First Aid / Im Notfall - Erste Hilfe

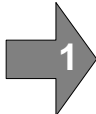
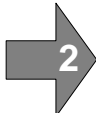
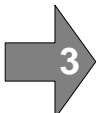

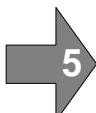

| | | |
|---|--|--|
| | <p>First Aid in case of accidents by electrical shocks</p> <p>5 Safety steps to follow if someone is the victim of electrical shock</p> | |
|  | Do not touch the injured person while the generator is running. | |
|  | Switch off the generator immediately. | |
|  | If you cannot switch off the generator, pull, push, or lift the person to safety using a wooden pole, rope or some nonconducting material. | |
|  | Call an emergency doctor as soon as possible. | |
|  | Immediately start necessary first aid procedures. | |

2.1 WHEN AN ADULT STOPS BREATHING

DO NOT attempt to perform the rescue breathing techniques provided on this page, unless certified. Performance of these techniques by uncertified personnel could result in further injury or death to the victim.

Warning:

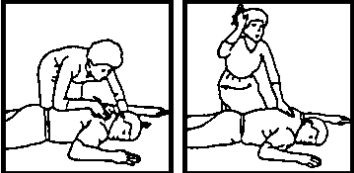
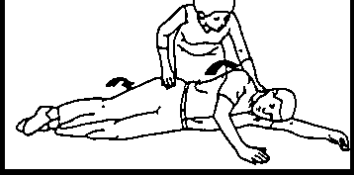
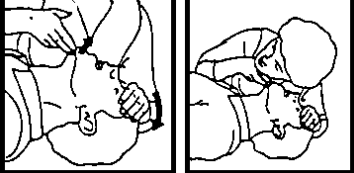

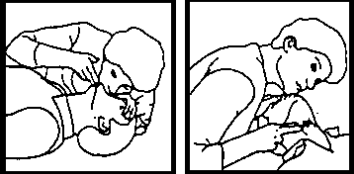
| | | |
|--|---|--|
| <p>1 Does the Person Respond? Tap or gently shake victim. Shout, "Are you OK?"</p> |  | <p>2 Shout, "Help!" Call people who can phone for help.</p> |
| <p>3 Roll Person onto Back. Roll victim towards you by pulling slowly.</p> |  | |
| <p>4 Open Airway. Tilt head back, and lift chin. Shout, "Are you OK?"</p> |  | <p>5 Check for Breathing. Look, listen, and feel for breathing for 3 to 5 seconds.</p> |
| <p>6 Give 2 Full Breaths. Keep head tilted back. Pinch nose shut. Seal your lips tight around victim's mouth. Give 2 full breaths for 1 to 1½ seconds each.</p> |  | |
| <p>7 Check for Pulse at side of Neck. Feel for pulse for 5 to 10 seconds.</p> |  | <p>8 Phone EMS for Help. Send someone to call an ambulance.</p> |
| <p>9 Begin Rescue Breathing. Keep head tilted back. Lift chin. Pinch nose shut. Give 1 full breath every 5 seconds. Look, listen, and feel for breathing between breaths.</p> |  | <p>10 Recheck Pulse Every Minute. Keep head tilted back. Feel for pulse for 5 to 10 seconds. If victim has pulse, not breathing, continue rescue breathing. If no pulse, begin CPR.</p> |

3. Basics

3.1 Intended use of the machine

The Fischer Panda generator is made to produce electrical energy out of diesel fuel.

The diesel fuel is converted to mechanical energy by the diesel engine. This mechanical energy drives the generator. In the genset, the mechanical energy is converted to electrical energy. This process is controlled by (sometimes external) components, the remote control panel and the voltage control system (VCS).

For the process is a sufficient amount of fuel and combustion air necessary. Arising exhaust and heat must be lead away.

If the electrical power should be applied to a local net, The regulation and installation instructions of the Net owner and the regional authorities must be respected. This includes lightning conductor, personal protection switch etc.

Misapplication of the Product can damage and destroy the product and the electrical net inclusive all load which is attached to the net, and contain hazards like short circuit. It is not allowed to modify the product in any case. Never open the sound cover during operation. The safety and hazard notes of the manual must be respected.

3.1.1 Purpose of the manual and description of the definitions trained person/operator/user

This manual is work instruction and operation instruction for the owner and user of Fischer Panda generators.

The manual is the base and the guideline for the correct installation and maintenance of Fischer Panda Generators.

The manual does not substitute the technical evaluation and should be used as an example guide only.

The installation must be undertaken and proved by a suitable qualified/trained person and may in accordance with the law as required by the country and special situation.

3.1.1.1 Trained persons

Trained persons for the mechanical components are motor mechanics or persons with similar education and training.

Trained persons for the electrical components are electricians or persons with similar education and training.

After the Installation, the trained person must instruct the owner for operation and maintenance of the generator. This must include the hazards of the generator use.

3.1.2 Operator

The operator is the for the operation of the generator responsible person.

After the installation, the operator must be instructed for the operation ad maintenance of the generator. This must include the hazards during operation of the generator and a instruction for the maintenance.

The operator must read and follow the manual and must respect the hazard notes and safety instructions.

3.1.2.1 User

Users are persons, established by the operator, to operate the generator.

The operator must assure that the user read and understand the manual and that all hazard notes and safety instructions are respected. The user must be instructed by the operator regarding his activity at the generator.

3.2 Scope of delivery

The Fischer Panda PMS generator system contains following components:

3.2.1 Asynchronous Generator:

Fischer Panda Generator

representative picture

Fig. 3.2-1: Fischer Panda Generator



Remote control panel

representative picture

Fig. 3.2-2: Remote control panel



AC Control Box

The AC Control Box contains the capacitors and the control circuit board (VCS) for the generator.

At ND generators and generators with mini VCS the capacitors and the VCS may mounted at the generator. The AC Control Box is not required for this generators.

representative picture

Fig. 3.2-3: AC Control Box

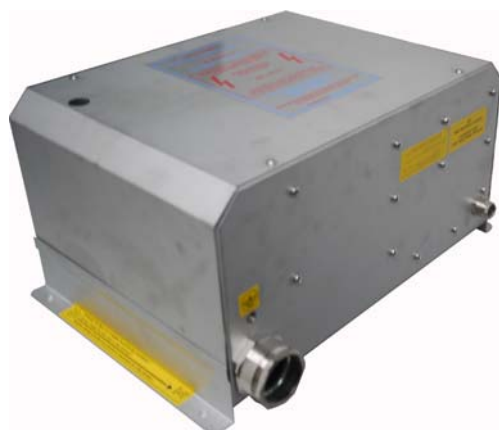

Fischer Panda Manual

The Fischer Panda Manual contains following components:

- Clear foil bag with general informations ect.
- Generator manual with added remote control panel manual
- Spare part catalogue „Installation & Service Guide“
- Engine manual from the engine manufacturer.
- Wiring diagram for the generator

representative picture

Fig. 3.2.1-4: Fischer Panda Manual



Optionales components f.e.:

- Fuel pump
- Installation kit
- Water lock
- ect.

3.3 Panda Transport Box

3.3.1 Bolted Fischer Panda Transport Box

1. Remove the bolts for cover / sidewalls
2. Remove the cover
3. Remove the loose accessories
4. Remove the bolts for sidewalls / floor pallet
5. Remove the sidewalls
6. Open the generator attachment

3.3.2 Fischer Panda Transport Box with metal tab closure

1. Bend up the metal tab closures on the transport box lid.
2. Remove the cover
3. Remove the loose
4. Bend open the metal tab closures on the transport box bottom.
5. Remove the sidewalls
6. Open the generator attachment

3.3.3 Opening the MPL sound insulation capsule

To open the sound insulation capsule, the closures must be rotated roughly 180° counter-clockwise. Use a flat head screwdriver. Pull the sidewalls out by gripping into the slots.



Closure locked

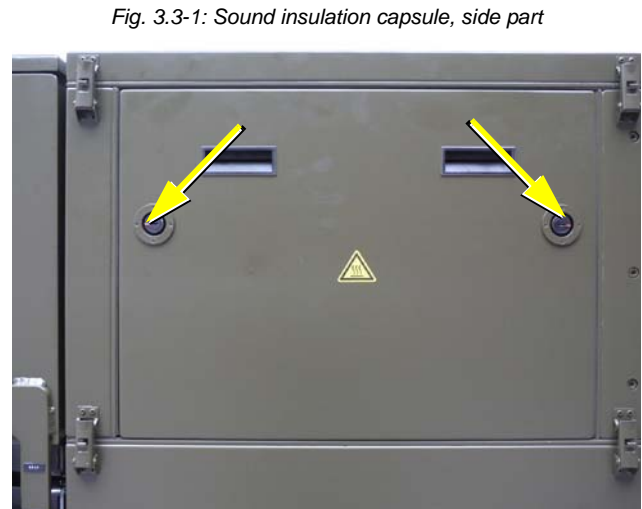

Fig. 3.3-1: Sound insulation capsule, side part

Fig. 3.3-2: Closure locked



Closure open

Fig. 3.3-3: Closure open



3.3.4 Opening the GFK sound insulation capsule

GFK sound insulation capsule with lash closures

Fig. 3.3-1: Lash closures



To open the lash closures pull the handle in arrow direction and lift the lash of the closure pin. After lifting of the lashes, the sound isolation cover upper parts can be removed.

Fig. 3.3-2: Lash closures



3.4 Transport and Loading/Unloading

3.4.1 Transporting the generator

- The generator must always be upright for transport.
- For transport, the Fischer Panda Transport Box shall be used for the generator. The generator shall be securely attached to the bottom of the box.
- For loading/unloading, an adequate industrial truck shall be used.
- Depending on the transport distance (e.g. air cargo), the generator fluids (coolant, engine oil, fuel) may have to be drained. The corresponding instructions and warnings must be fitted to the transport packaging.

3.4.2 Loading/unloading of the generator

For loading/unloading the generator, appropriate ring eye bolts shall be installed in the holes in the support rails. The load bearing capacity of each ring eye bolt must at least equal the generator weight.

**An adequate lifting yoke shall be used for transport/
loading**

Fig. 3.4-1: Lifting yoke (example)



4. Panda 4000s Neo PMS generator

4.1 Type plate at the generator

Fig. 4.1-1: Type plate

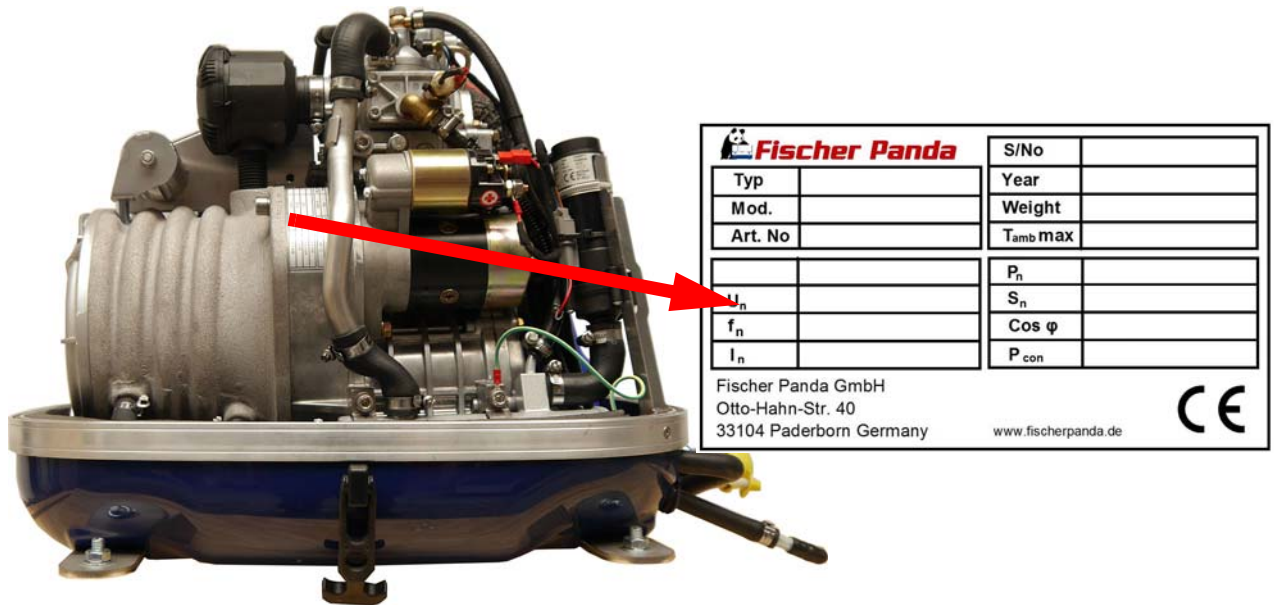
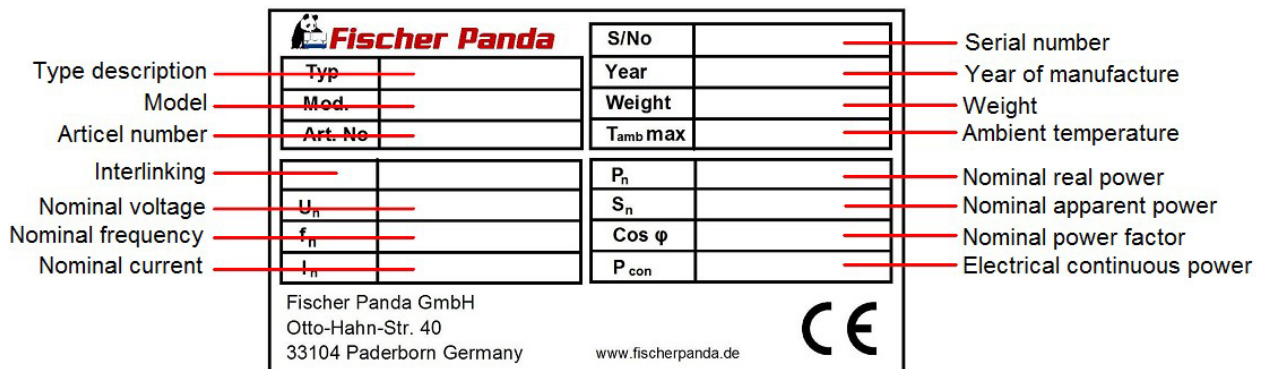

Fig. 4.1-2: Discription type plate



4.2 Description of the Generator

4.2.1 Right Side View

Fig. 4.2.1-1: Right side view

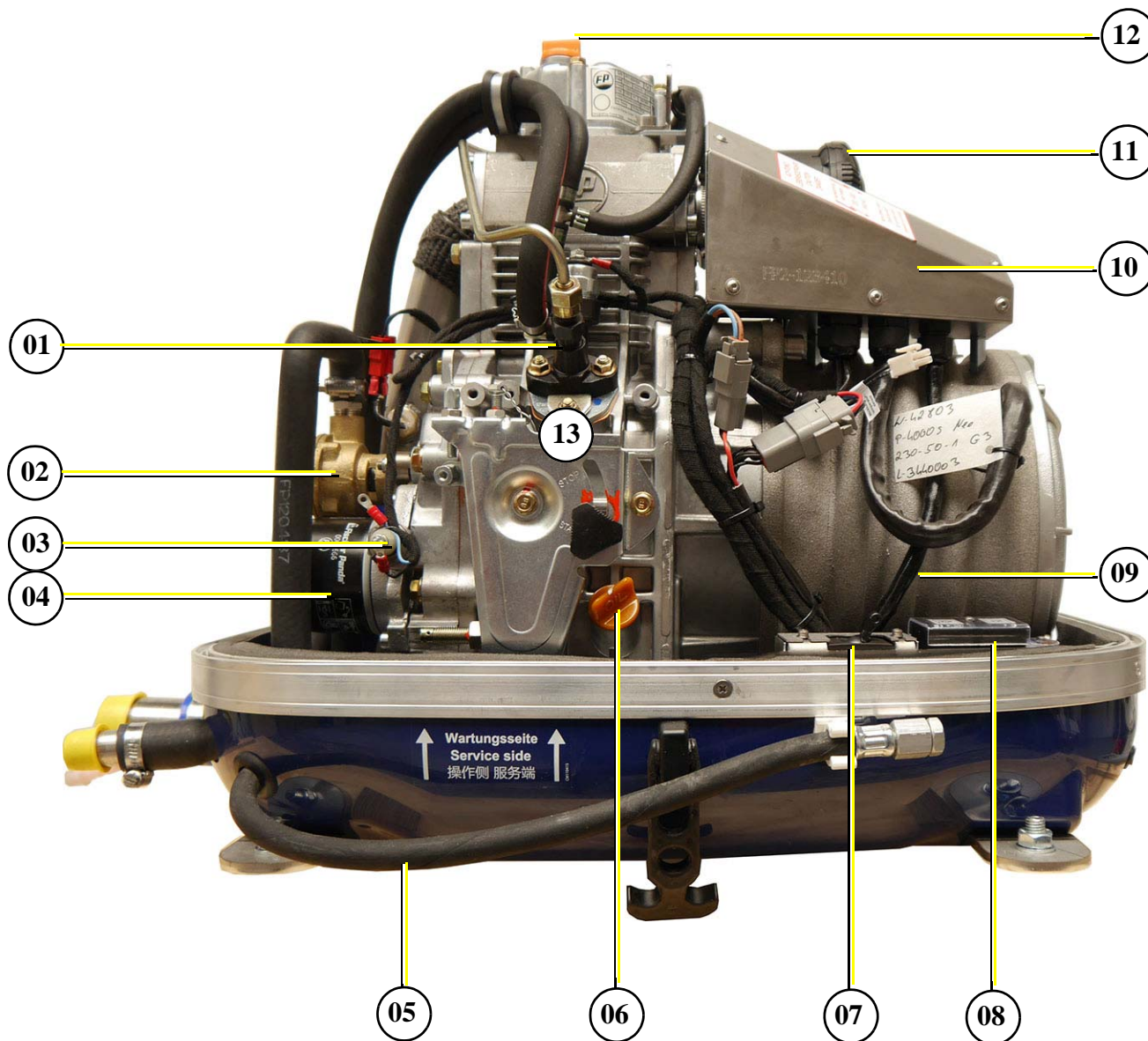

- 01) Fuel stop solenoid
- 02) Raw water pump
- 03) Oil pressure switch
- 04) Oil filter
- 05) Oil drain hose
- 06) Dip stick
- 07) Circuit breaker 15A for AC power out

- 08) DC fuses and relays
- 09) Generator housing with coil
- 10) Generator power distribution box
- 11) Air filter housing
- 12) Oil filler cap
- 13) Injection pump

4.2.2 Left Side View

Fig. 4.2.2-1: Left side view

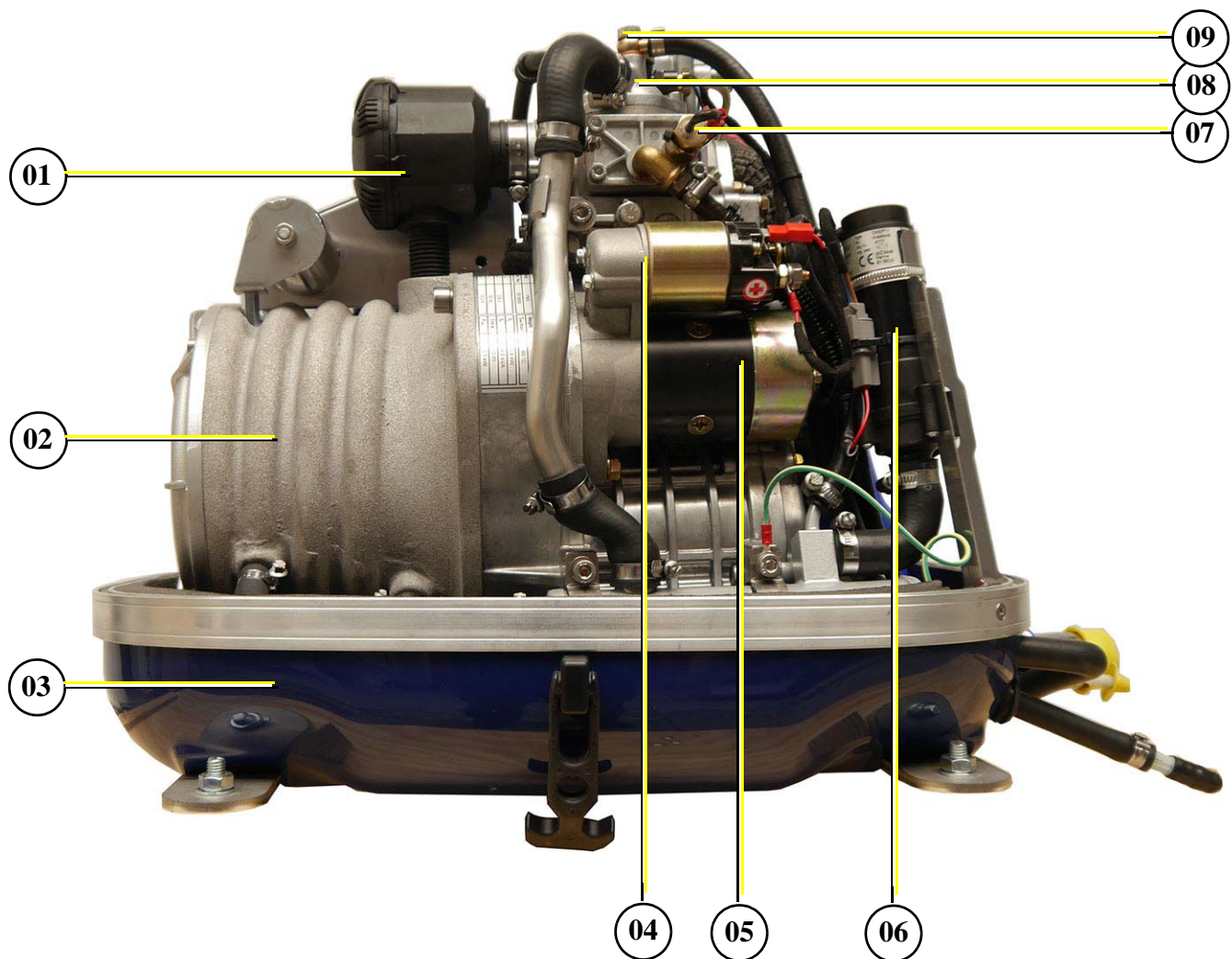

- 01) Air filter housing with air filter
- 02) Generator housing with coil
- 03) Sound cover base part
- 04) Solenoid switch for starter motor
- 05) Starter motor

- 06) Electrical fresh water pump
- 07) Temperature sensor at cylinder head
- 08) Thermostat housing
- 09) Bleeding screw at thermostat housing

4.2.3 Front View

Fig. 4.2.3-1: Front side view

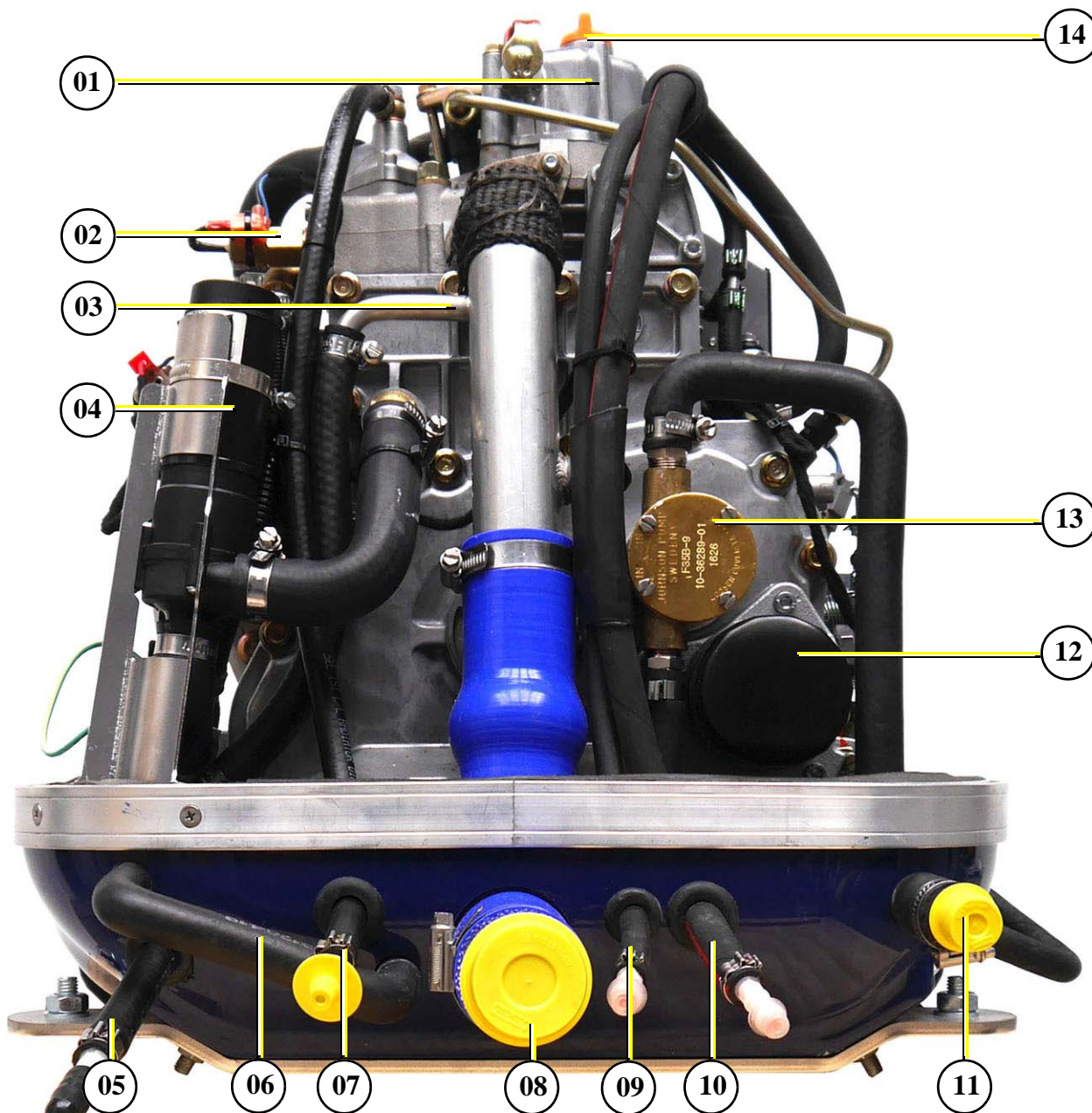

- | | |
|--|----------------------|
| 01) Valve cover | 08) Exhaust out |
| 02) Thermo sensor at cylinder head | 09) Fuel return line |
| 03) Raw water injection nozzle | 10) Fuel feed line |
| 04) Fresh water pump | 11) Raw water in |
| 05) Coolant feed line from external expansion tank | 12) Oil filter |
| 06) Connection for external ventilation valve | 13) Raw water pump |
| 07) Coolant bleeding line to external expansion tank | 14) Oil filler cap |

4.2.4 Back View

Fig. 4.2.4-1: Back side view

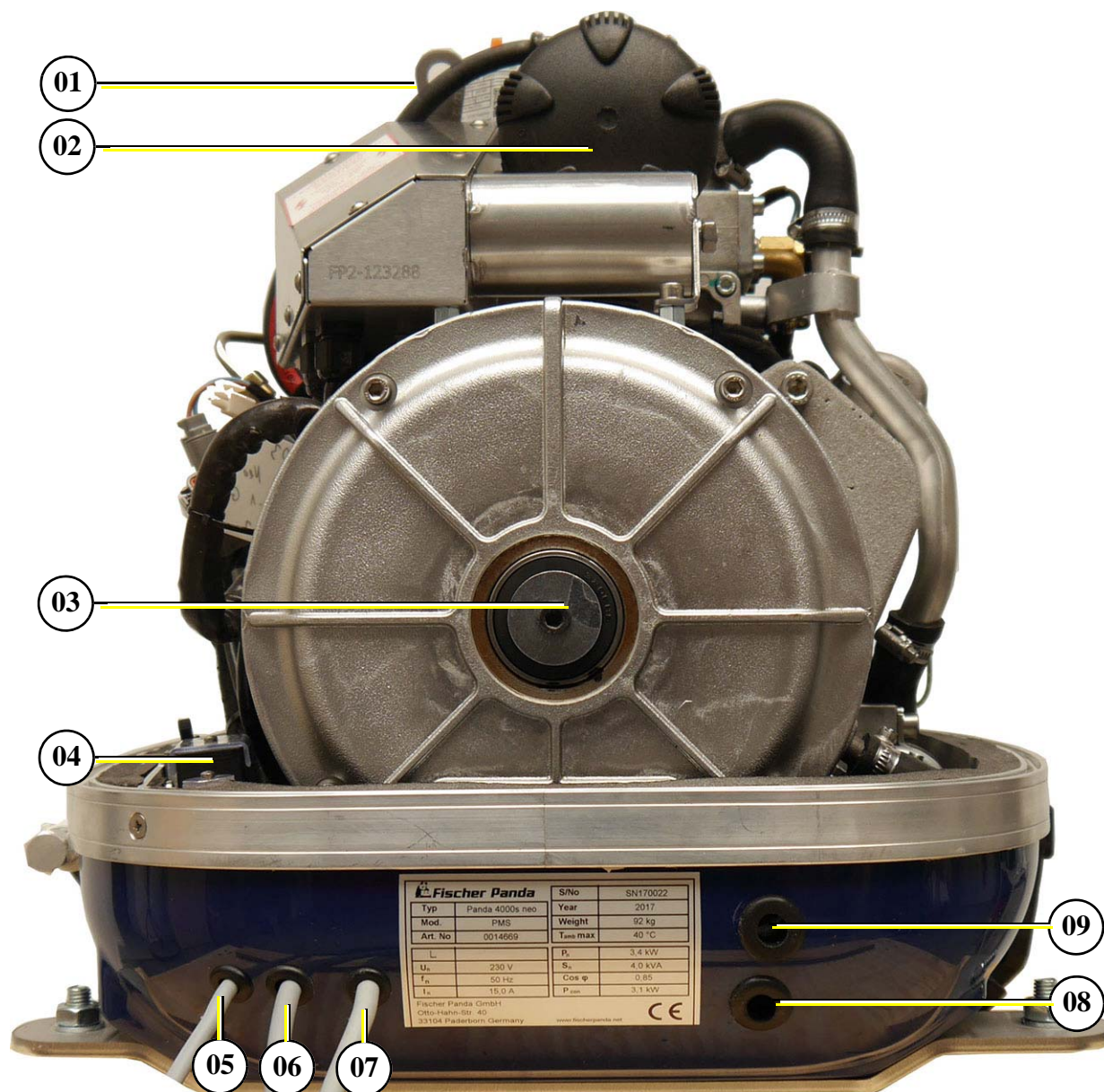

- 01) Lifting eye
- 02) Air filter
- 03) Generator housing back cover
- 04) Fuses and relays
- 05) Cable for fuel pump

- 06) Cable generator power out
- 07) Cable for remote control panel
- 08) Passage for starter battery cable
- 09) Passage for starter battery cable

4.3 Details of function units

4.3.1 Control panel

The control panel is fitted with various monitoring functions, which increase functional reliability and operating safety of the generator. Various parts of the generator are monitored with sensors which, when triggered, generate an error message and can shut down generator operation under certain circumstances to prevent damage.

Fig. 4.3-1: Remote Control Panel - Front Side

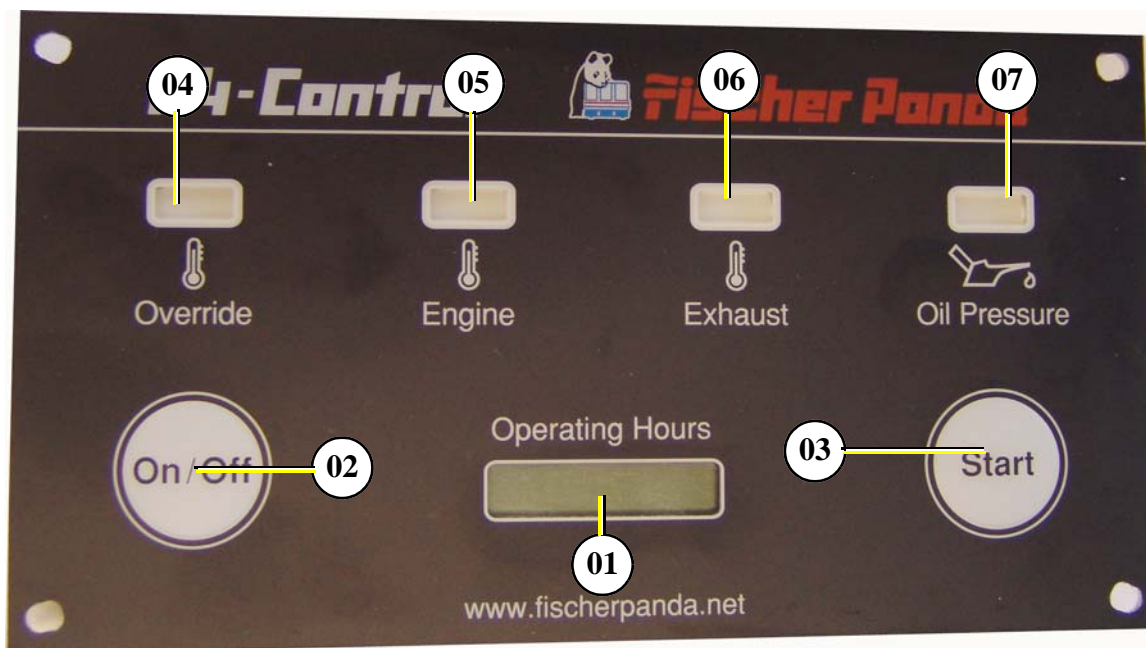

- | | |
|------------------------------|---|
| 01) Display operating hours | 05) Warning light for engine temperature |
| 02) Power „ON/OFF“-button | 06) Warning light for exhaust temperature |
| 03) Generator „Start“-button | 07) Warning light for oil pressure |
| 04) Control light „Override“ | |

See remote control panel data sheet for details!

Notice!:



4.3.2 Components of the Cooling System

Fig. 4.3.2-1: Cooling System

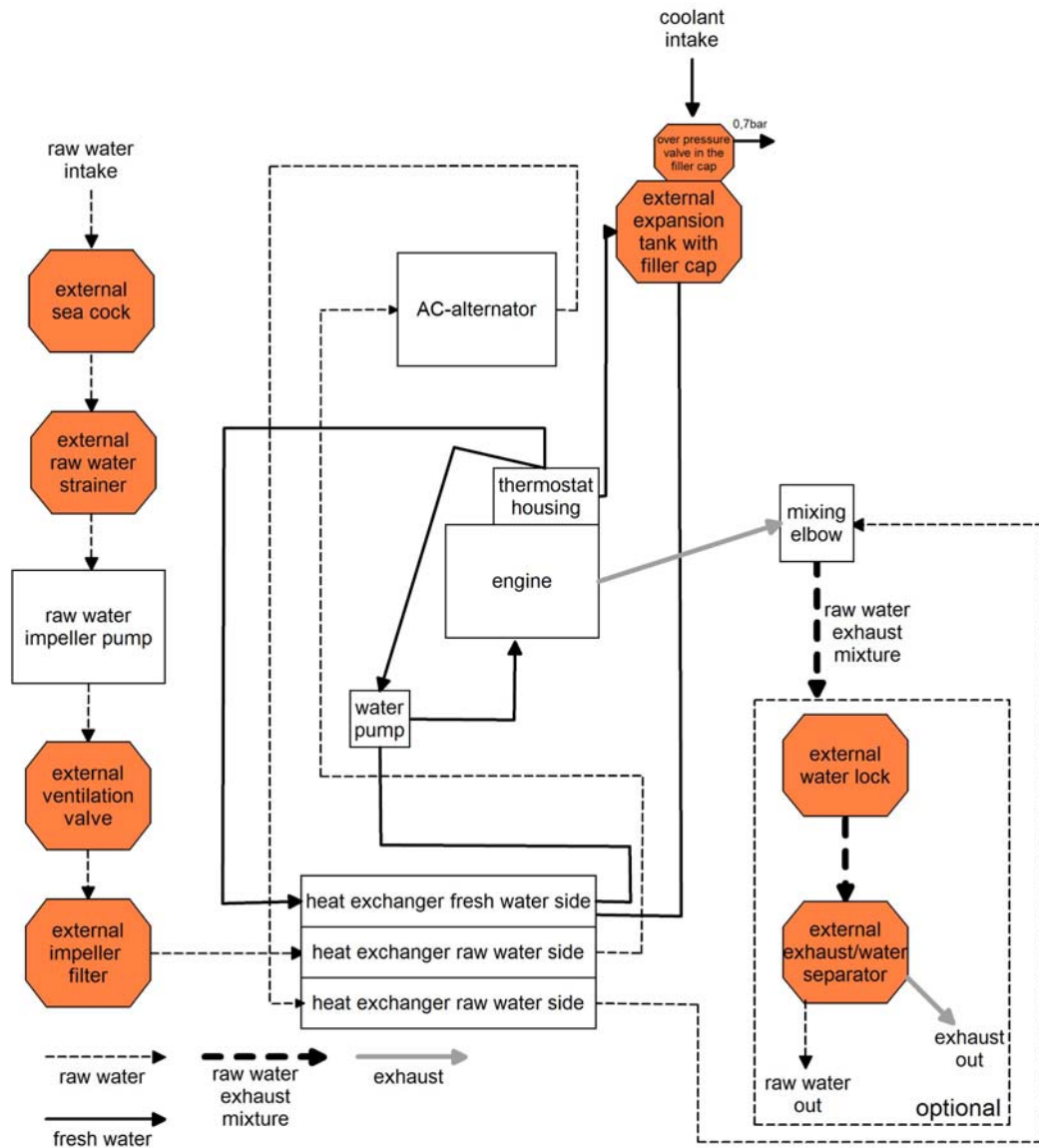

4.3.3 Components of the Fuel System

Fig. 4.3.3-1: Components of the Fuel System

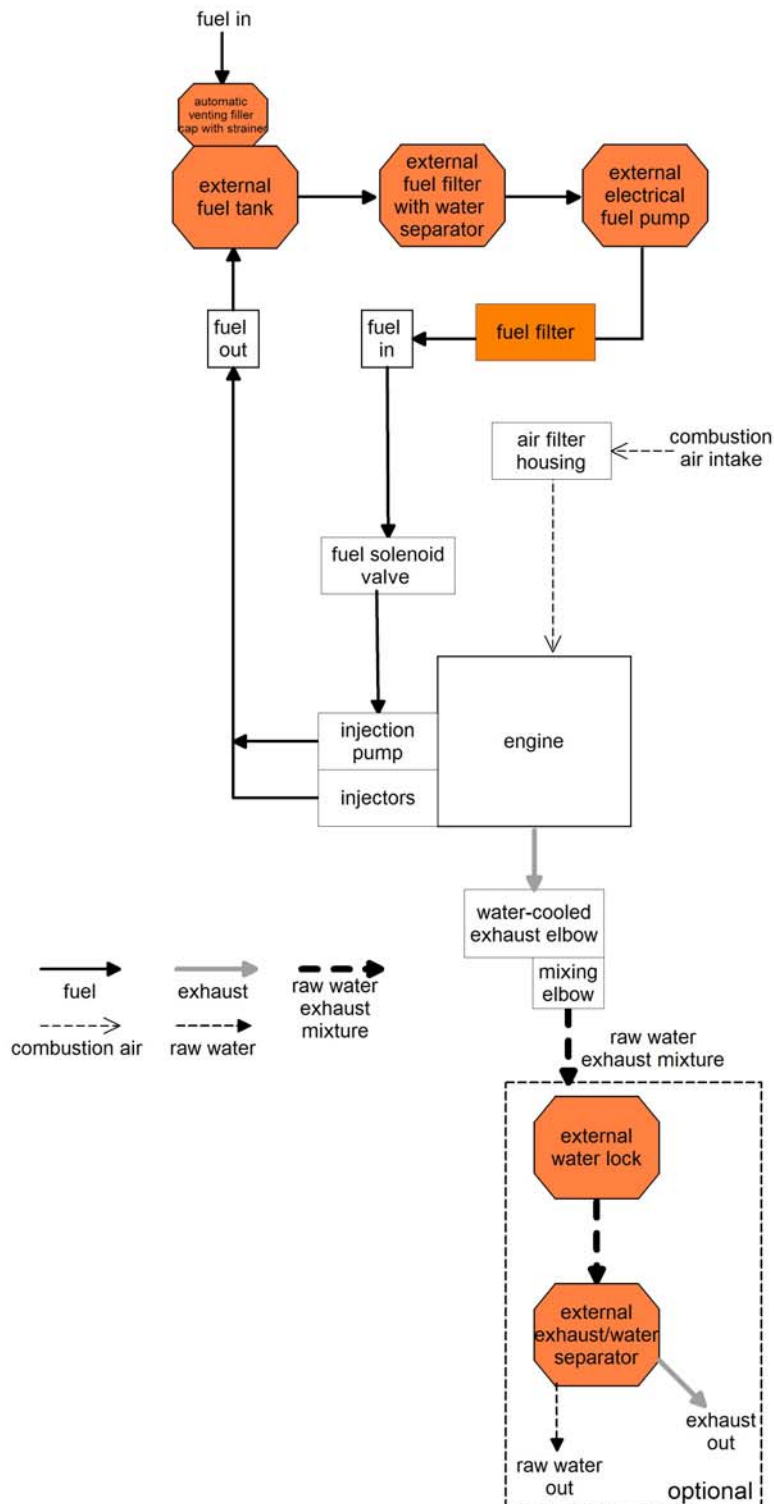

4.3.4 Components of the Electrical System

Fig. 4.3.4-1: Components of the Electrical System

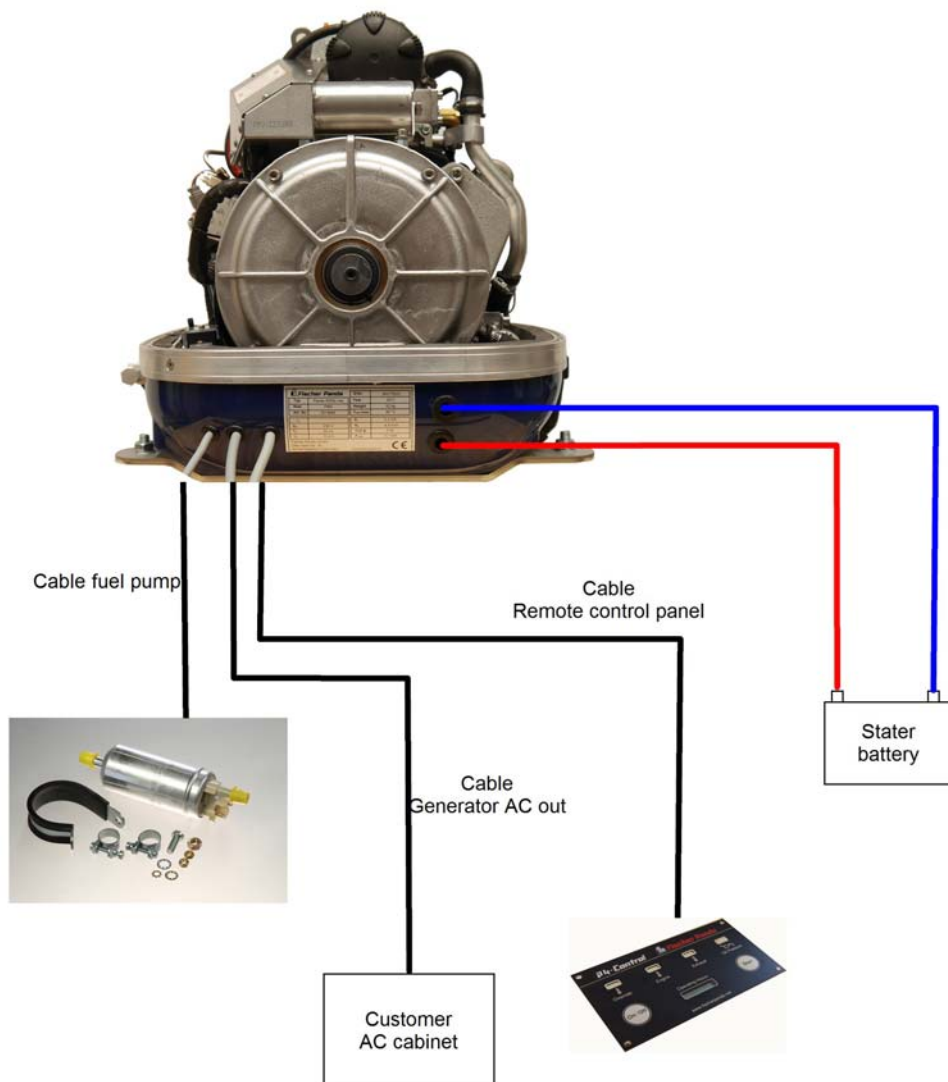

4.3.5 Components of the Oil Circuit

Fig. 4.3.5-1: Components of the Oil Circuit

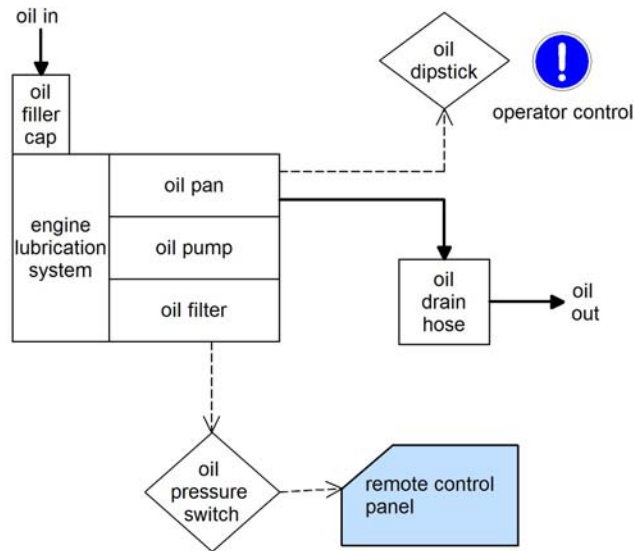

4.3.6 Sensors and switches for operating surveillance

Thermo-sensor at engine

The thermo-sensor at the engine is used for monitoring the engine temperature.

Fig. 4.3.6-1: Thermo.sensor at engine

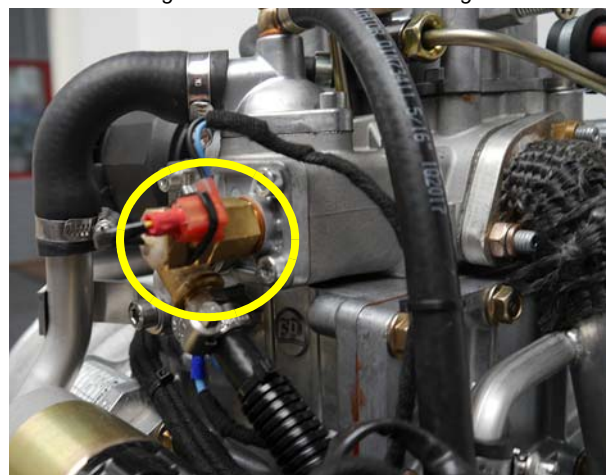

Thermo-switch at exhaust connection

If the impeller pump drops out and delivers no more seawater, the exhaust connection becomes extremely hot.

Fig. 4.3.6-2: Thermo-switch at exhaust connection



Thermo-sensor coil

One thermo sensor is located in the stator winding

Fig. 4.3.6-3: Thermo-switch coil

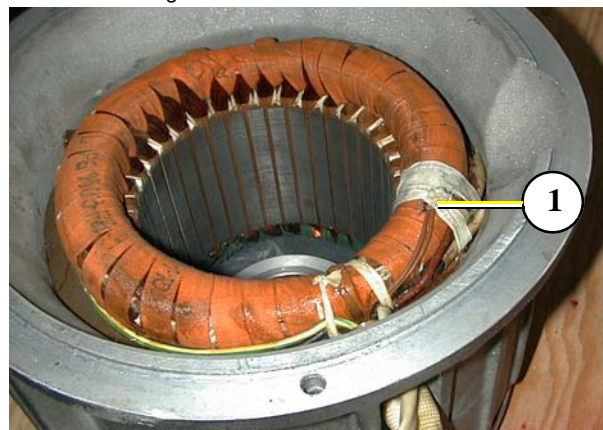

Oil pressure switch

In order to be able to monitor the lubricating oil system, an oil pressure switch is built into the system.

Fig. 4.3.6-4: Oil pressure switch

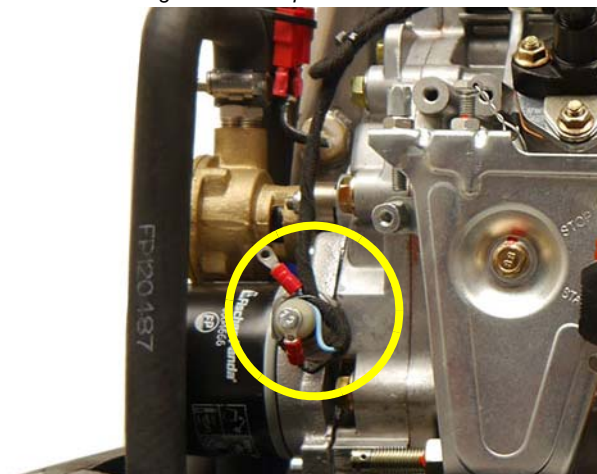

4.4 Operation Instructions - See separate remote control panel manual

4.4.1 Daily routine checks before starting - See remote control panel manual.

4.4.2 Starting Generator - See remote control panel manual.

4.4.3 Stopping the Generator - See remote control panel manual.

5. Installation Instructions

All connections (hoses, wires etc.) and installation instructions are designed and suited for “standard” installation situations.

In situations where Fischer Panda has no detailed information concerning certain installation requirements (such as vehicle specifications, maximum vehicle speed - and all other conditions concerning special operating situations) the installation instructions should be used as an example guide only. The installation must be undertaken and proved by a suitable qualified/trained person and should be in accordance with the law as required by the country and special situation.

Damages caused by faulty or incorrect installation are not covered by the warranty.

Attention!: Adapt system correctly.



5.1 Personal requirements

The described installation must be done by a technical trained person or a Fischer Panda service point.

5.1.1 Hazard notes for the installation

Follow the general safety instruction at the front of this manual.

Notice:



DANGER TO LIFE! - Incorrect handling may lead to health damage and to death.

.Warning!: Automatic start



Always disconnect the battery bank (first negative terminal than positive terminal) before you work at the generator or the electric system of the generator so that the generator may not be started unintentionally.

Improper installation can result in severe personal injuries or material damage. Therefore:

Warning!: Risk of injury



- Always undertake installation work when the generator is switched off.
- Ensure there is sufficient installation clearance before start working.
- Ensure tidiness and cleanliness at the workplace. Loose components and tools lying around or on top of each other are sources of accidents.
- Only perform installation work using commercially available tools and special tools. Incorrect or damaged tools can result injuries.

Oil and fuel vapours can ignite at contact with ignition sources. Therefore:

- No open flames during work on the generator.
- Do not smoke.
- Remove oil and fuel residues from the generator and floor.

Contact with engine oil, antifreeze and fuel can result in damage to health. Therefore:

- Avoid skin contact with engine oil, fuel and antifreeze.
- Remove oil and fuel splashes and antifreeze from the skin immediately.
- Do not inhale oil and fuel vapours.

DANGER TO LIFE! - Improper handling can result in severe personal injury and death.

Electrical voltages above 60 volts (battery chargers greater than 36 volts) are always dangerous to life. The rules of the respective regional authority must be adhered to. Only an electrician may carry out installation of the electrical connections for safety reasons.

Generator, oil and antifreeze can be hot during/after operation. Risk of severe burns!

During operation an over pressure in the cooling system may be established.

Batteries contain corrosive acids and bases.

Improper handling can lead to heating of the batteries and bursts. Corrosive acids and bases may leak. Under bad conditions it may lead to an explosion.

Consider the instructions of the battery manufacturer.

During installation/maintenance personal protective equipment is required to minimize the health hazards:

- Protective clothing
- Safety boots
- Protective gloves
- Ear defender
- Safety glasses

Disconnect all load during the work at the generator to avoid damages at the load.

Warning!: Danger of fire



Danger!: Danger of poisoning



Attention!: Danger to Life - High voltage



Warning!: Hot surface/material



Warning: Danger of chemical burns



Instruction!: Personal protective equipment necessary



Attention!: Disconnect all load.



5.2 Place of installation

5.2.1 Preliminary remark

- There must be sufficient fresh air supply for the combustion air.
- It has to be ensured that the cooling air supply from underneath or sidewise is sufficient.
- During operation the sea cock has to be opened.
- The generator may only be opened by a technical trained person.
- The generator may only be operated by a trained person.

5.2.2 Preparing the base - placement

Since Panda generators have extremely compact dimensions, they can be installed in tight locations. Attempts are sometimes made to install them in almost inaccessible places. Please consider that even almost maintenance-free machinery must still remain accessible at least at the front (drive belt, water pump) and the service-side (actuator, dipstick). Please also note that in spite of the automatic oil-pressure sensor it is still essential that the oil level has to be checked regularly.

The generator should not be placed in the proximity of light walls or floors, which can have resonance vibrations because of airborne sounds. If this should be unavoidable, then it is recommended that this surface is lined with 1 mm lead foil, which will change the mass and the vibration behaviour.

You should avoid fixing the generator on a slippery surface with little mass (i.e. plywood). This acts as an amplifier of airborne sounds in the most unreasonable case. An improvement can be achieved by reinforcing these surfaces with ribs. In addition, the breakthroughs, which interrupt these surfaces, should be sawed off. The lining of the surrounding walls with a heavy layer (i.e lead) and foam additionally improve the conditions.

As the generator sucks in its combustion air via several drill holes in the capsule base, the capsule base must be installed with sufficient space to the basement so that the air supply is guaranteed (at least 12 mm/½")

The generator sucks its air from the surrounding engine room. Therefore it must be ensured that sufficient ventilation openings are present, so that the generator cannot overheat.

The Power out of the generator based on the following data:

Ambient temperature: 20 °C

Air pressure: 1000 mbar (100 m above normal Zero)

Raw water temperature: 20 °C

Rel. áir moisture: 30 % reg. the ambient temperature

Fuel temperature: bis zu 20 °C

Exhaust backpressure: 80 mbar (at the exhaust out of the sound isolation cover)

Any different to this data, for example an ambient temperature of 40 °C because of the build inside a machine room/vehicle with a bad ventilation, will cause in a lower Power out (Derating).

5.2.3 Advice for optimal sound insulation

The convenient base consists of a stable framework, on which the generator is fastened by means of shock-mounts. Since the aggregate is „free“ downwards, the combustion air can be sucked in unhindered. In addition the vibrations are void which would arise with a closed capsule base.

Fig. 5.2.3-1: Generator base

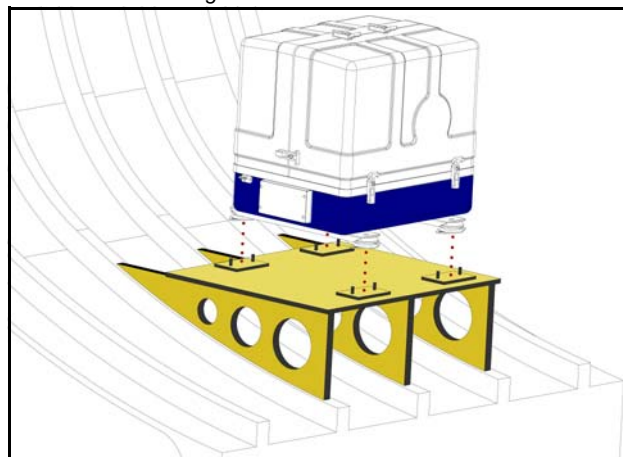

5.3 Generator Connections

All electrical wires are connected within the capsule tightly to the motor and the generator. This is also the case for fuel lines and cooling water lines.

The electrical connections **MUST** be carried out according to the respective valid regulations. This also concerns used cable materials. The cable supplied is meant for laying „protected“ (i.e. in pipe) at a temperature up to a max of. 70 °C (160 °F). The on-board circuit must also be fitted with all essential fuses.

Before working (installation) on the System read the section „Safety Instructions“ in this manual.

ATTENTION!



Fig. 5.3-1: Connection at the Generator - sample

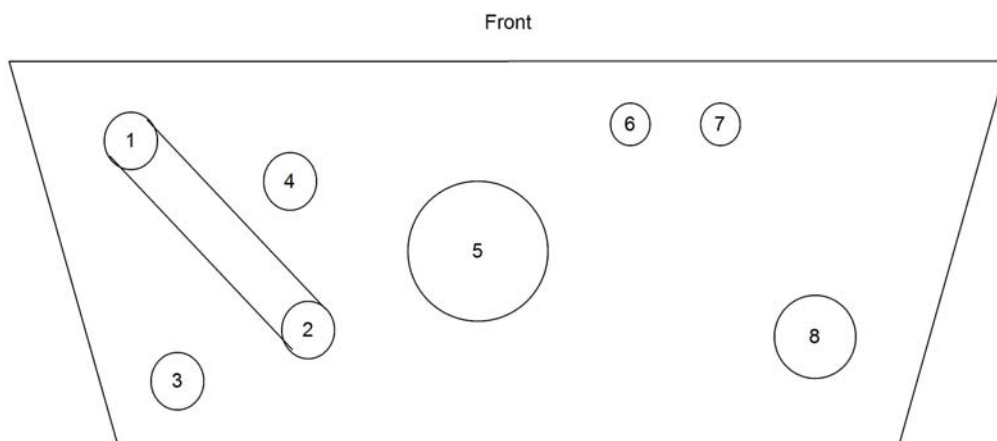

- 1. Connection for external ventilation valve
- 2. Connection for external ventilation valve
- 3. Feed line from external expansion tank
- 4. Bleeding line to external expansion tank

- 5. Exhaust out
- 6. Fuel return line
- 7. Fuel feed line
- 8. Raw water in

Fig. 5.3-2: Connection at the Generator - sample
Back



- 9. Cable fuel pump
- 10. Cable generator AC out
- 11. Cable for remote control panel
- 12. Passage starter battery cable
- 13. Passage starter battery cable

5.4 Installation of the cooling system - raw water

5.4.1 General information

The genset should have its own raw water (coolant water) inlet and should not be connected to any other engine systems. Ensure that the following installation instructions are complied with:

5.4.2 Installation of the through hull fitting in Yachts - scheme

It is good practice for yachts to use a through hull fitting with an integrated strainer. The through hull fitting (raw water intake) is often mounted against the sailing direction to induce more water intake for cooling.

For Panda generators, the through hull inlet should NOT point in the sailing direction! When sailing at higher speeds more water will be forced into the inlet than the pump can handle and your generator will flood.

Fig. 5.4.2-1: Position of the through hull fitting

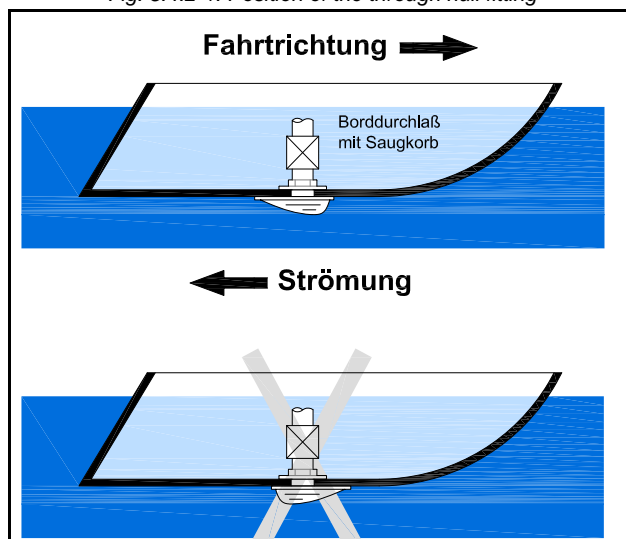

5.4.3 Quality of the raw water sucking in line

In order to keep the suction resistance in the line at a minimum, the raw water intake system must have an inner diameter of at least 1" (25 mm).

This applies also to installation components such as through-hull fitting, sea cock, raw water filter etc.

The intake suction line should be kept as short as possible. Install the raw water inlet in close proximity to the genset.

After start-up the cooling water quantity must be measured (e.g. by catching at the exhaust). For the flow rate see section 9.2, "Technical data," on page 118.

5.4.4 Generator installation above waterline

The Panda is equipped with a water intake pump mounted on the motor. Since the intake pump is an impeller pump there are wearing parts which are likely to require replacement after a period of time. Ensure that the genset is installed so that the intake pump can be easily accessed. If this is not possible, an external intake pump could be installed in an easily accessible location

If the generator is installed above the waterline, it is possible that the impeller will wear out faster, because after starting, the pump runs dry for some seconds. The raw water hose should form a loop as near as possible to the raw water inlet of the generator (see picture below). This ensures the pump only sucks in air for a short time. The impeller pump will be lubricated by raw water and the impeller life span will be increased. With the installation of a non return valve in the raw water inlet line, which is under the waterline, this problem can be restricted.

When starting the generator you should always consider when raw water runs out of the exhaust system. If this takes longer than 5 seconds you should replace the impeller pump because it sucks in air for too long before it delivers raw water. The impeller has lost its effect and cannot suck in raw water anymore. This results to an overheating of the motor. If the impeller is not exchanged early enough the impeller blades may break into pieces and plugging the cooling water cycle. It is very important to exchange the impeller after a couple of months.

If the raw water line is too long for the impeller pump or the generator installed too high above the water line a electrical pump can be installed into the raw water line. In this case the impeller should be removed out of the impeller pump.

NOTE:



Contact Fischer Panda for further information.

Never change the impeller for many years, without exchanging the old pump. If the sealing ring is defective within the pump, raw water runs into the sound cover of the genset. A repair is then very expensive.

NOTE:



Replacement impeller and also a spare pump should always be on board. The old pump can be sent back to Fischer Panda for cost-effective repair.

5.4.5 Generator installation below waterline

If the generator cannot be attached at least 600 mm above the waterline, a vent valve must be installed at the raw water line.

Possible heeling must be taken into consideration if installed at the "mid-ship line"! The water hose for the external vent valve is located at the back of the sound insulated capsule. This hose is split in the middle and extended respectively at each end by an additional hose and a connecting nipple. Both hose ends must be led outside of the sound cover, if possible 600 mm over the waterline in the mid-ship line. The valve is connected at the highest place to the two hose ends. If the valve jams the cool water line cannot be de-aerated after stopping the generator, the water column is not discontinued and water can penetrate into the combustion

Fig. 5.4.5-1: Vent valve



chamber of the engine. This will lead to damage the engine in a short term!

Fig. 5.4.5-2: Rubber hose for vent valve - example



The rubber hose for the external vent valve will be cut...

...and bend upwards.

Both hose ends will be extended respectively with a hose and connected with a vent valve 600 mm over the waterline.

Example

Fig. 5.4.5-3: Split rubber hose for vent valve

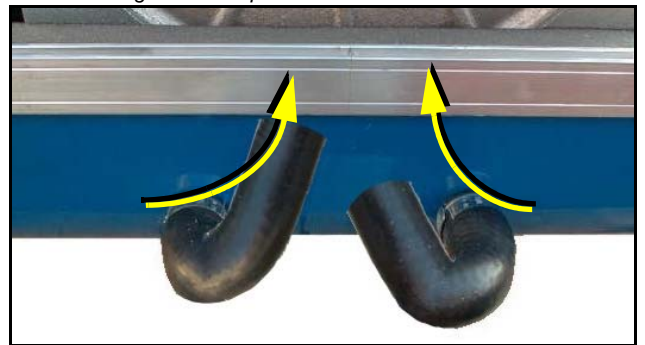

5.4.5.1 Raw water installation scheme

Fig. 5.4.5.1-1: Raw water installation scheme

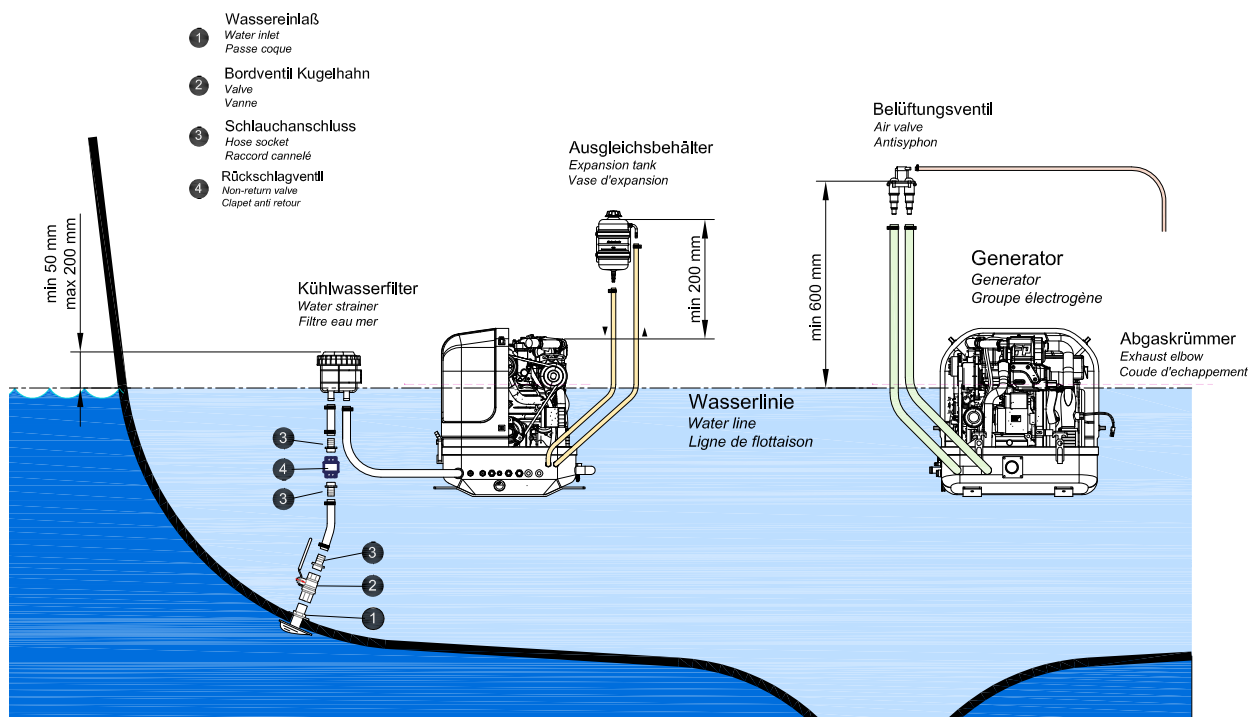

5.4.6 First filling and ventilation of the internal cooling water circuit

The expansion tank is supplied with a pressure relief valve in the cap with 500 mbar. It is possible when operating the generator hot cooling water can leak here if there is an overpressure. When working always wear protective clothing and ensure an adequate installation location.

1. Fill up the external cooling water expansion tank with coolant.

ATTENTION: Maximum fill level = „max.“- marking

The cover of the external expansion tank must be opened temporarily (all other closures are now closed!).

Sample picture

ATTENTION!: Risk of scalding.



Fig. 5.4.6-1: Expansion tank



2. Open venting screw at the thermostat housing. Close the vent screw when air free water comes out.

Check the water level in the expansion tank during the venting. Fill up if necessary.

Fig. 5.4.6-2: Venting screw at the thermostat housing

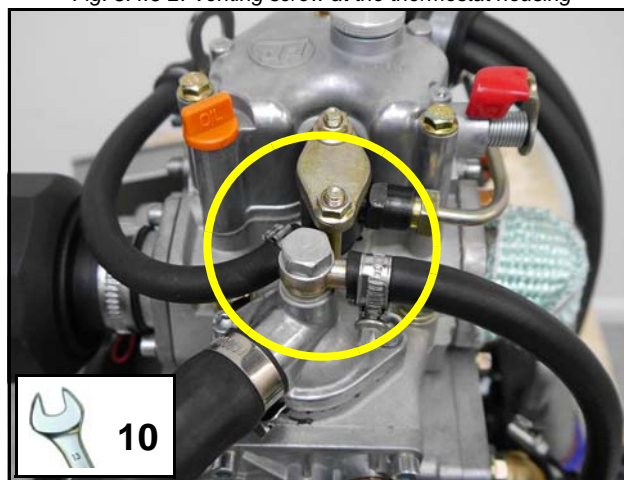

3. Start the generator

After filling the generator must be started. During this first phase of start-up, the generator may not be loaded.

Switch off the generator after approx. 10 seconds of operation!

4. Repeat the steps 1-3 till no more air comes out of the venting screw at the thermostat housing.

Close the venting screws.

5. Run the generator at idle speed till the cooling water temperature at the engine reach 60°C. Stop the generator.

Fill up the expansion tank up to max. marking.

Close the expansion tank.

6. Re-venting process 10 operating hours after the first start-up (and if necessary).

Also after the first initial operation a small amount of air may reside in the cooling circuit. To ensure an immaculate und actual operation of the cooling system the ventilating process must be repeated casual in the next few days (weeks, if necessary). Small amount of air will still exit out of the ventilating openings, especially if the generator stood still for a long time.

During the ventilating process repeated checks must be made to check the cooling water is indeed circulating. If there are air bubbles in the internal cooling water pump, it is possible that the cooling water is not circulating. The generator will heat up very quickly and switch off, because of overheating.

ATTENTION: Check circulation



5.4.6.1 Anti-freeze in the cooling water circuit

In the interest of safety, the concentration of the coolant should be checked on a regular basis. Be sure that the coolant/antifreeze mixture is good for at least -15 °C (5 °F) which is recommended by the manufacturer. If your genset experiences lower temperatures, for example during storage or transportation, then the entire cooling system should be drained. The coolant also serves as corrosion protection of the engine.

5.4.7 Temperature check for controlling the cooling water circuit

Check with an IR-thermometer if a temperature difference exists between cooling water in-flow and cooling water return flow.

The cooling water in-flow line can be measured directly at the internal cooling water pump.

The cooling water return pipe can be measured either at the outlet of the water-cooled exhaust elbow or at the side where this pipe enters the heat exchanger.

The temperature difference between in-flow and return should be approx 2-3 °C at nominal rating.

5.5 Installation of the water cooled exhaust system

5.5.1 Installation of the standard exhaust system

The generator exhaust system must remain completely independent and separate from the exhaust system of any other unit(s) on board. The water lock must be installed at the lowest point of the exhaust system. An optional noise insulated water lock can also be installed. The exhaust hose descends from the capsule to the water lock. Then the hose rises via the „goose neck“ to the silencer (see drawing). The goose neck must be vertical and sit preferably along the ship's keel centre line. In order that the back pressure inside the exhaust is not too high, the total length of the exhaust system should not exceed 6,3 m.

By injecting the outlet raw water into the exhaust manifold, the exhaust gases are cooled and the noise emissions from the exhaust system are reduced.

Fig. 5.5.1-1: Installation Scheme Standard Exhaust System

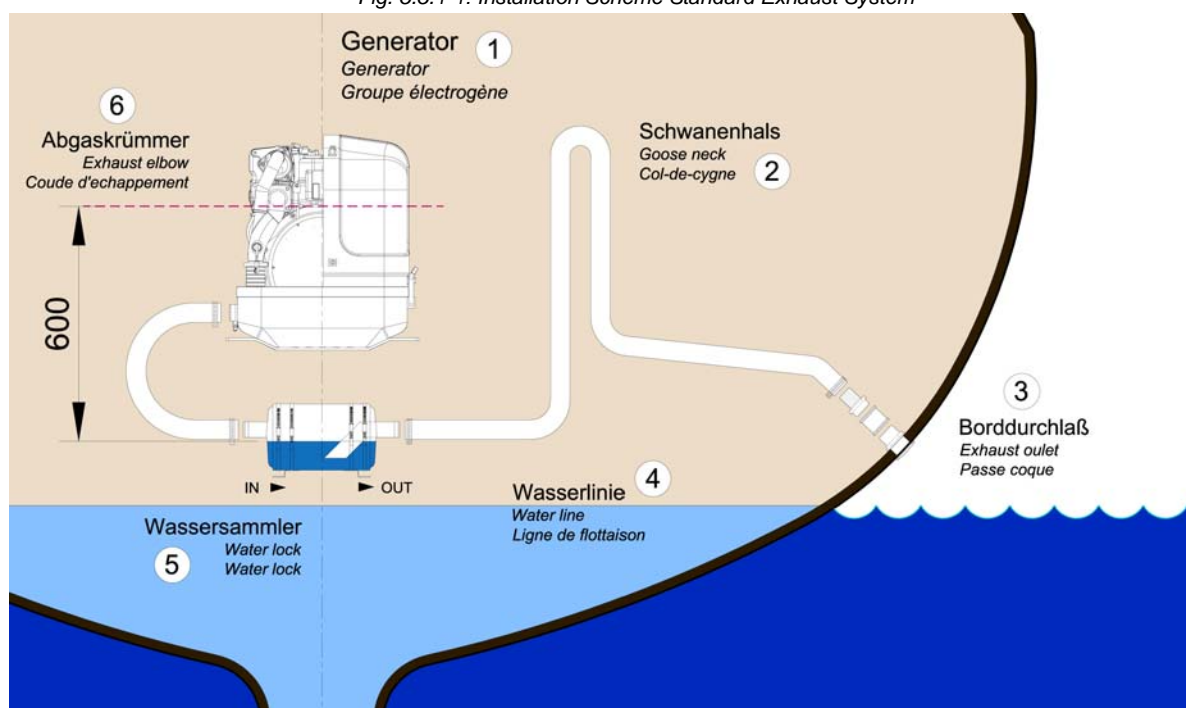

5.6 Installation of the waterlock

Pay attention to the right flow direction through the waterlock.

Note!:



Unfortunately, it can occasionally occur that, because of an disadvantageous mounting position of the waterlock, sea water gets into the diesel engines' combustion chamber. This disables the diesel engine by irreversible damages. Quite frequently, this leads to discussions during which the parties involved in the yachts' construction or the installation of the generator have to explain themselves.

One point in this situation can be clarified definitely:

If sea water gets into the inner section of the engine, this is not possible due to constructional defects of the generator or to malfunctions on the engine itself. It can only reach the combustion chamber via the exhaust hose and thus get into the engine.

Thereby, the position of the generator and the waterlock, as well as the arrangement of the cooling water and exhaust hoses play the decisive role.

If the waterlock is arranged in an unfavourable position, the cooling water flowing back in the exhaust hose can rise so high, that it reaches the exhaust stack. Since at least one discharge valve is always open when the engine is shut off, the sea water has free access to the combustion chamber. By capillary action, this sea water then flows past the cocks and even reaches the engine oil in that way. (In fact, a surprisingly high oil level is a first indication of an upcoming catastrophe).

If an usual high oil level can be detected and/or the oil is of a greyish colour, the engine must not be used anymore. This is a certain sign for cooling water that got into the oil pan. If the engine is started under these conditions, the water and the oil are mixed into an emulsion. The oil will quickly become so viscous that one will have to call it a paste. In this phase the fine oil hoses are blocked and a few moments later the machine gets destroyed because of insufficient lubrication. Before this happens, an immediate oil change should be made. Since the water can only reach the engine via the combustion chamber, it can be assumed that the compression rings will start to corrode. These effects have to be discussed with an engine expert. It will certainly be reasonable to immediately inject plenty penetrating oil through the intake stack and to slowly turn the engine with the starter motor.

The cooling water can reach the exhaust area via the exhaust hose as well as via the cooling water feed.

5.6.1 Possible cause for water in the exhaust hose

5.6.1.1 Possible cause: exhaust hose

If the cause is the exhaust hose itself, the following points are to be checked at the hose:

- a) Position of the waterlock is too high. The water reaches the exhaust hose.
- b) Position of the waterlock is too far away from the middle of the generator. The water reaches the exhaust hose in tilted position.
- c) The waterlock is too small relating to the length of the exhaust hose.

5.6.1.2 Possible cause: cooling water hose

If the generator is not clearly installed 600 mm over the water line, the cooling water feed must be equipped with a „venting valve“ which is at least led out 600 mm over the water line. (This position must also be assured in every tilted position. Therefore, the venting valve should be located in the ships' center line, so that it cannot move in tilted position).

- a) Position of the venting valve is too low. The water flows into the exhaust area when the ship is tilted.
- b) Position of the venting valve is too far from the ships' center line. The water reaches the exhaust area when the ship is tilted.
- c) The venting valve does not work, because it jams or it is clotted. (The venting valve's function needs to be checked regularly.)

As it consistently happens that functioning risks are not realised during the laying of the exhaust hose, the following explanations refer explicitly to the exhaust hose. Here, the location, the size and the position of the „waterlock“ play a very decisive role:

5.6.2 Installation area of the waterlock

Concerning a water-cooled exhaust system, it must be regarded that - under no circumstances - cooling water from the exhaust hose can get into the exhaust elbow area at the engine. If this happens, the cooling water can get into the combustion chamber via an open discharge valve. This would lead to irreparable damage at the engine.

In addition to that, one has to reckon with possible tilted positions of sailing yachts, which makes the position of the waterlock even more important. In general one could say that:

The deeper the waterlock is located underneath the generator, the better the protection from entering water into the combustion chamber.

The picture below shows that the distance between the critical point at the exhaust elbow and the maximum permissible water level in the exhaust hose is stated with 600 mm. This distance should be understood as a minimum distance.

5.6.3 The volume of the waterlock

The waterlock must be measured so large, that it can take the entire amount of water flowing back from the exhaust hose. The amount of water depends on the hoses' length (L) and its cross section. While the diesel engine is running, cooling water is continuously injected into the exhaust system and is carted outside with the emissions by the exhaust gas pressure. When the engine is turned off, the number of revolutions sinks quite fast. By doing so, the point is reached where the exhaust gas pressure does not suffice anymore to cart the cooling water out. All cooling water remaining in the hose at that point flows back into the waterlock. At the same time, the diesel engine itself continues to cart cooling water through the cooling water pump, as long as it keeps on rotating.

The waterlock must necessarily be measured large enough that it can take the entire amount of cooling water and, at the same time, does not exceed the prescribed vertical height of 600 mm up to the critical point at the exhaust elbow.

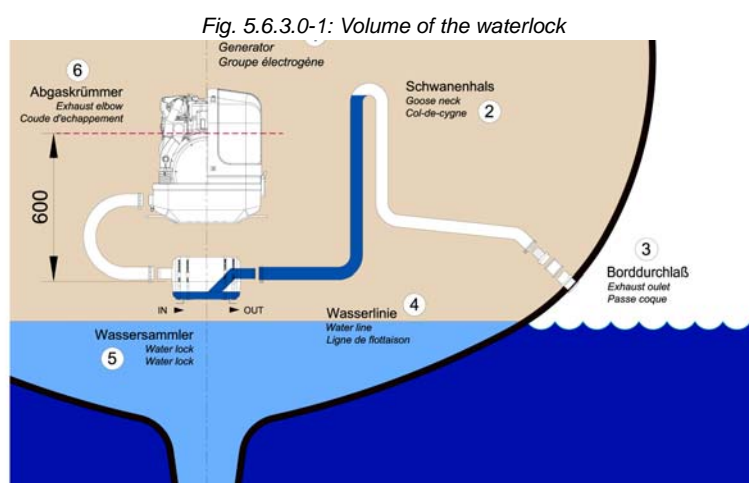

If there are any doubts, a verification can easily be made by temporarily using a clear-sighted hose (1) as exhaust hose. In that way, the cooling water level can be checked very easily.

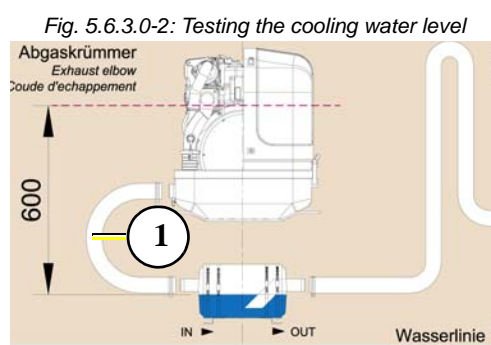

5.6.3.1 Ideal position of the waterlock

The ideal position of the waterlock would be in center underneath the generator.

Only in this position it is assured that the water level cannot change drastically in tilted position by the waterlock moving out of the center line.

See the following pictures:

Important Note!



In Fig. 5.6.3.1-1, the waterlock is mounted in center underneath the generator.

When the ship tilts, the position of the waterlock related to the critical point at the exhaust hose, changes only slightly.

Fig. 5.6.3.1-1: Ideal position of the waterlock

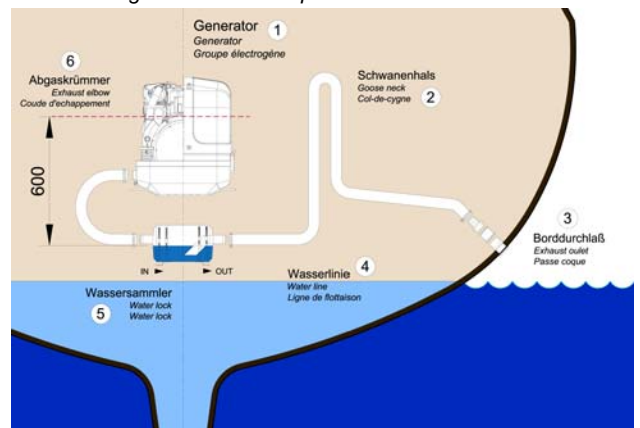

Tilted position 15 degrees - Fig. 5.6.3.1-2

The distance from the exhaust elbow to the hydrostatic head has derated to 540 mm.

Fig. 5.6.3.1-2: Tilted position 15 degrees

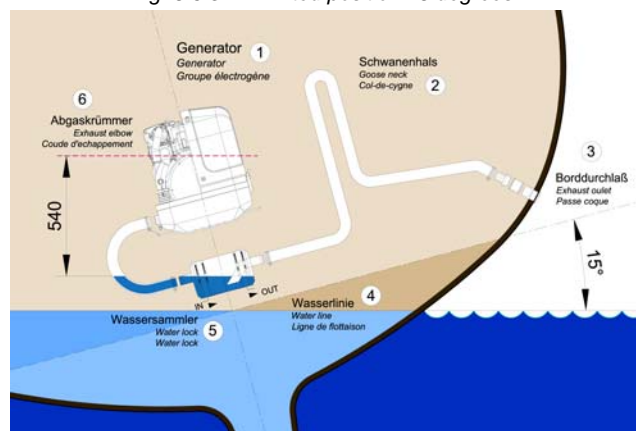

Tilted position 30 degrees - Fig. 5.6.3.1-3

The distance of the water level, even in ideal position, changes that only 458 mm distance remain. So the critical distance is under-run already.

Fig. 5.6.3.1-3: Tilted position 30 degrees

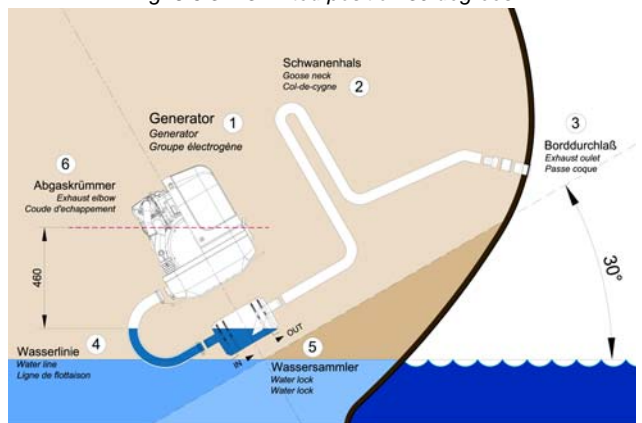

Tilted position 45 degrees - Fig. 5.6.3.1-4

In this case the water level rise so high, that the distance constitutes only 325 mm.

Even when the water lock is mounted in the ideal spot, at an extremely tilted position of 45 degrees there is still the risk that water can get straight into the discharge stack area through strong rocking motions („sloshing“). This shows that the distance of 600 mm represents a minimum size at which, even when installed ideally, the water can slosh into the exhaust elbow when the ship is very tilted or rocks very hard.

Fig. 5.6.3.1-4: Tilted position 45 degrees

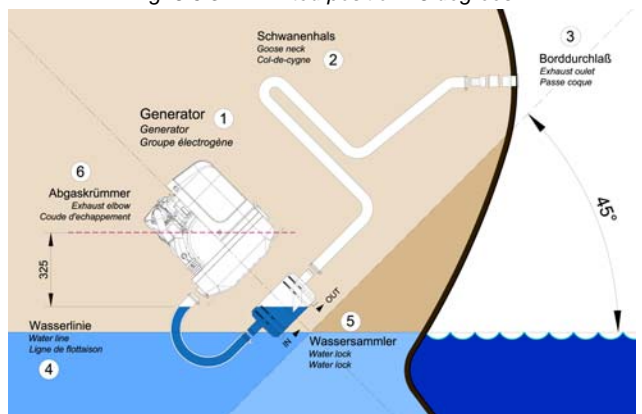

Summary:

The preset minimum height of 600 mm must be regarded unconditionally and is only valid if the waterlock is mounted in its ideal position in center underneath the generator. A higher position is highly recommended if it has to be reckoned with tilted positions of 45 degrees.

5.6.3.2 Example of the installation of the waterlock off-center and possible effects:

The following pictures are primarily relevant for an installation of the generator with the waterlock on sailing yachts. A change in the mounting position caused by tilted position does not have to be reckoned concerning motor yachts. Here it is only necessary to regard that the volume of the waterlock is measured so large that it can take the entire amount of water flowing back, and at the same time, maintains the minimum distance of 600 mm.

A) Installation of the waterlock 500 mm next to the generator's center line:

Installation of the waterlock 500 mm next to the generator's center line

Fig. 5.6.3.2-1: waterlock, 500 mm next to the center line

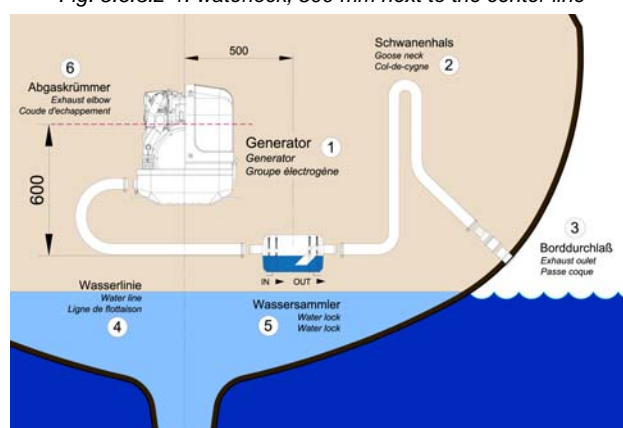

Tilted position 45 degrees - Fig. 5.6.3.2-2

The water level is now at the same height as the critical point at the exhaust elbow. If the ship is sailed in a tilted position of 45 degrees with an installation like this, the ingress of cooling water into the combustion chamber is inevitable. Irreparable damages are pre-programmed.

Fig. 5.6.3.2-2: Tilted position 45 degrees

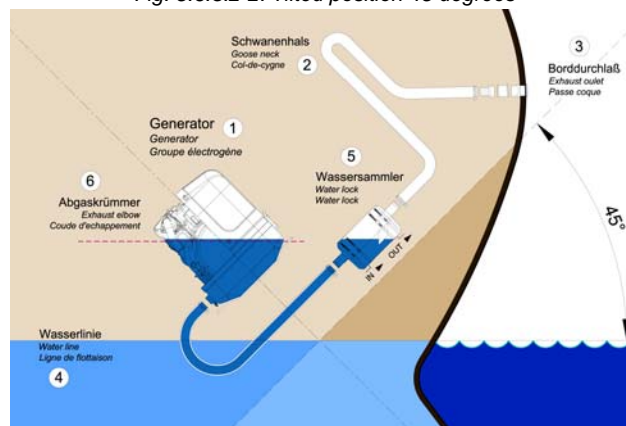

B) Installation distance between waterlock and the generator’s center line 1000 mm

Installation distance between waterlock and the generator’s center line 1000 mm

Fig. 5.6.3.2-3: waterlock, 1000 mm next to center line

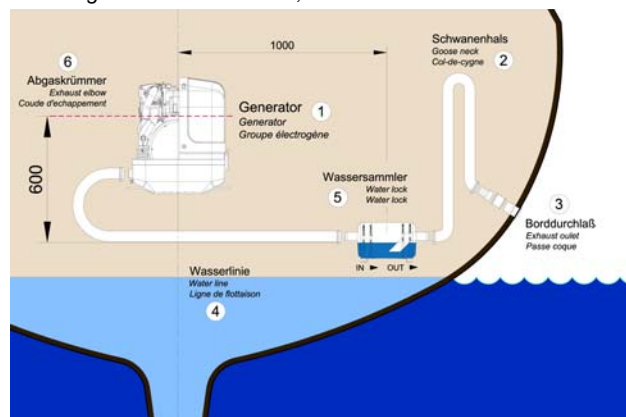

Tilted position 30 degrees - Fig. 5.6.3.2-4

The water level and the critical point at the exhaust elbow are at the same level now. If the ship is sailed in a tilted position of 30 degrees with an installation like that, the infiltration of cooling water into the combustion chamber is inevitable. Irreparable damages are pre-programmed.

Fig. 5.6.3.2-4: Tilted position 30 degrees

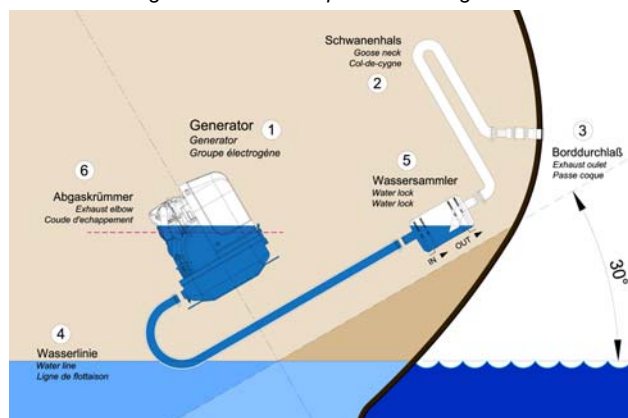

Summary:

Concerning sailing yachts it must be regarded, that the waterlock is mounted in center underneath the generator, at least in reference to the ships’ center line. Thus the waterlock is prevented from „leaking“ very strongly when the ship is tilted.

The „leaking“ of the waterlock leads to a rise of the water level which then gets too close to the exhaust elbow’s critical point.

5.7 Exhaust / water separator

In order to reduce the noise level of the generator unit to a minimum, an optional exhaust outlet muffler can be mounted next to the through-hull fitting. Additionally there is a component at Fischer Panda, which acts as both an „exhaust goose neck“, and water separator. With this „exhaust/water separator“ the cooling water is derived over a separate pipe. The exhaust noises emanating from the exterior of the yacht are strongly decreased. Particularly the „water splash“.

Fig. 5.7.0-1: Installation Scheme exhaust / water separator

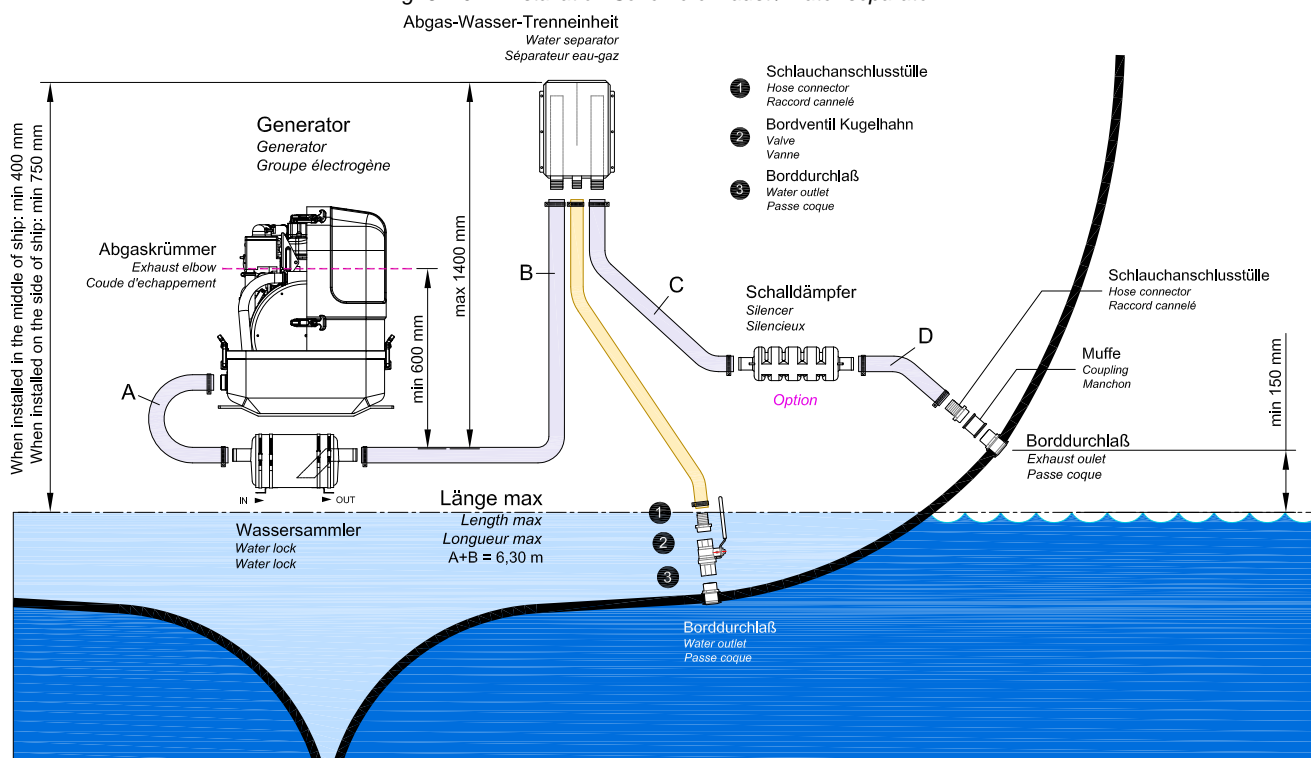

5.8 Installation exhaust water separator

If the exhaust water separator was sufficiently highly installed, a goose neck is no longer necessary. The exhaust/water separator fulfils the same function. If the „Super silent“ exhaust system were installed correctly, the generator will not disturb your boat neighbour. The exhaust noise should be nearly inaudible. The best result is reached, if the hose line, which derive the cooling water, is relocate on a short way „falling“ directly to the outlet and this outlet is under the waterline.

If the through-hull exhaust outlet has to be mounted far from the generator, an exhaust-water separator must definitely be installed. The raw water from the separator must then run along the shortest possible path in the through-hull outlet. For such long exhaust routes, the exhaust hose diameter should also be increased, f.e. from NW40mm to NW50mm in order to reduce the back-pressure. The exhaust may have a length of over 10 m (32 ft.) if the exhaust hose diameter is increased. An additional outlet exhaust muffler close to the hull outlet will help further to reduce noise emissions.

The generator will not disturb your boat neighbours, if the „Super silent exhaust system has been correctly installed. The exhaust noise should be almost inaudible.

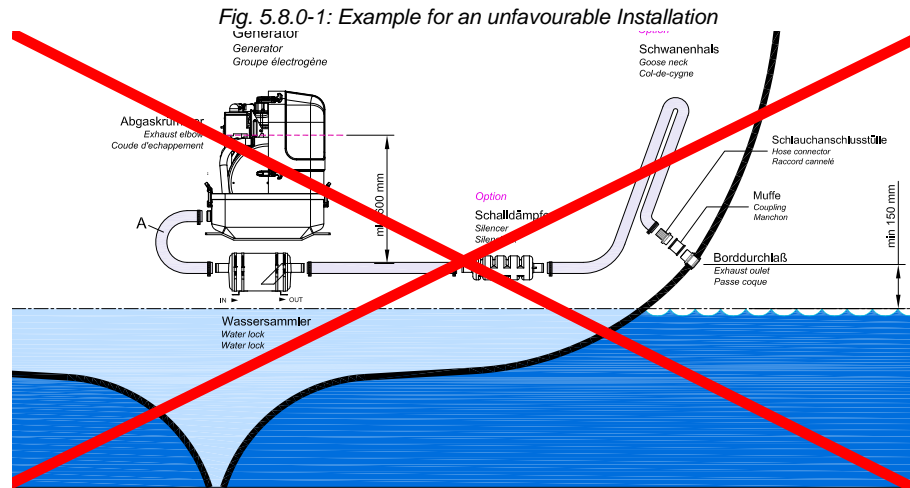

Example of an unfavourable installation:

- Water lock not far enough below the lowest level of the generator
- Distance water lock to gooseneck too large

5.9 Fuel system installation

5.9.1 The following items need to be installed:

- Fuel supply pump (DC)
- Pre-filter with water separator (not part of the delivery)
- Fine particle fuel filter
- Return fuel line to fuel tank (unpressurized)

The external Fuel pump should be installed near the fuel tank

Electrical fuel pump

With the Fischer Panda generator is usually supplied an external, electrical fuel pump (DC). The fuel pump must be installed close at the fuel tank. The electrical connections is prepared at the generator.

Some generators (f.e. with Deutz diesel engine) has an engine driven internal fuel pump. At these generators the electrical fuel pump is optional.

Fig. 5.9.1-1: electrical fuel pump



Fig. 5.9.1-2: Fuel system - schema

Achtung:
Kraftstoffpumpe so tief wie möglich installieren
maximale Saughöhe der Pumpe beträgt: 500mm
maximale Förderhöhe der Pumpe beträgt: 2500mm

Note:
Fuel pump installed as deep as possible
maximum suction lift of the pump is: 500mm
maximum pump head is: 2500mm

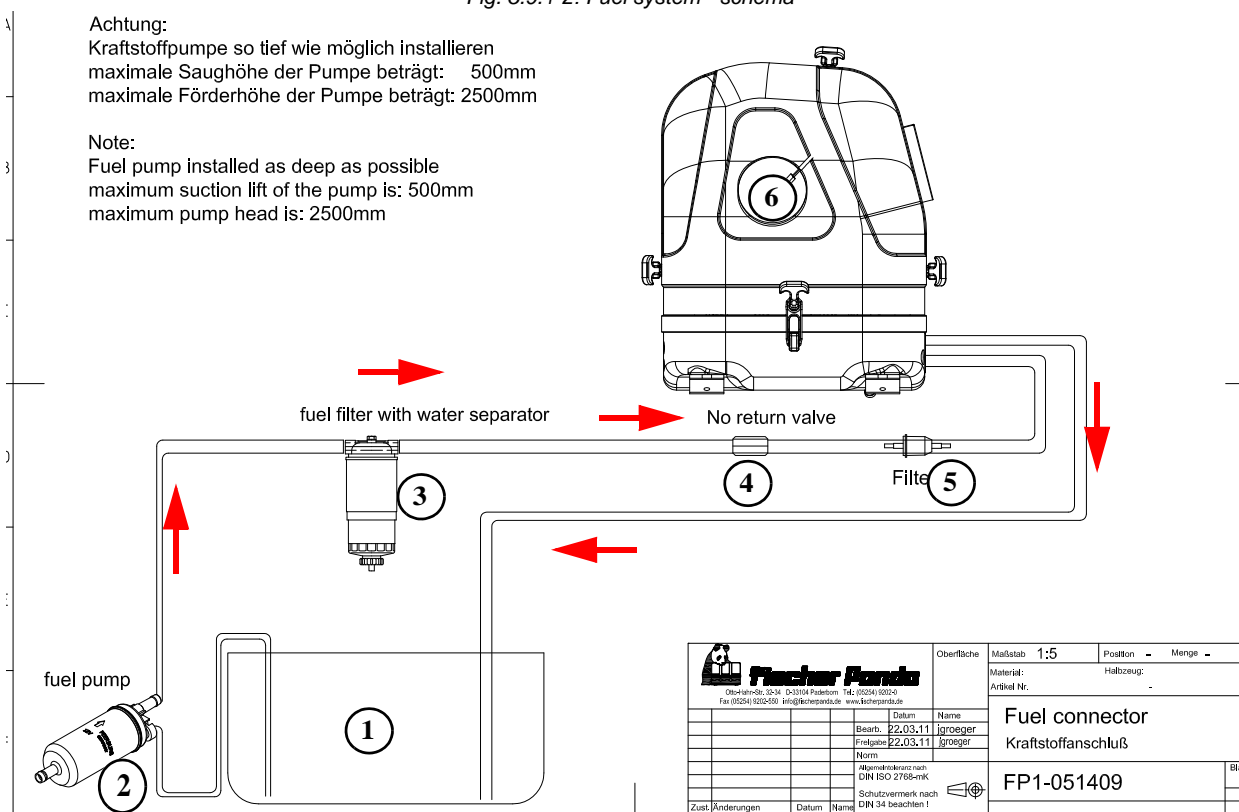

- 1. Fuel tank
- 2. External fuel pump
- 3. External fuel prefilter with water separator

- 4. Non return valve
- 5. External fuel fine filter
- 6. Generator

| | | | | |
|---|-------|-----------------------|----------------|--------------------|
|  <small>Gb-Hafenstraße 10-16 D-33104 Paderborn Tel: 05254/9200-0 Fax: 05254/9200-550 info@fischerpanda.de www.fischerpanda.de</small> | | Oberfläche | Maßstab 1:5 | Position - Menge - |
| | | Materiell: | Halbzeug: | |
| | | Artikel Nr.: | | |
| | | Name | Fuel connector | |
| | | Bearb. 22.03.11 | igroeger | |
| | | Prüfung 22.03.11 | igroeger | |
| | | Norm | | |
| | | Abnormenotierung nach | FP1-051409 | |
| | | DIN ISO 2768-mk | | |
| | | Schutzvermerk nach | | |
| | | DIN 34 beachten! | | |
| Zust./Änderungen | Datum | Name | Blatt - B | |

External fine filter

At generators with FP 320, Kubota EA 300 or Farymann engines, the fine filter is delivered with the generator. This fine filter should be installed in the fuel feed line next to the generator.

Fig. 5.9-3: externer Feinfilter



5.9.2 Connection of the fuel lines at the tank

General fuel feed and return line must be connected to the tank at separate connection points.

Note:



Connection of the return pipe to the tank

The return pipe connected to the tank must be dropped to the same depth as the suction pipe, if the generator is mounted higher than the tank, in order to prevent fuel running back into the tank after the motor has been switched off, which can lead to enormous problems, if the generator is switched off for a long period.

Non-return valve in the suction pipe

A non-return valve must be fitted to the suction pipe, which prevents the fuel flowing back after the generator has been switched off, if it is not possible to use the return flow pipe as a submerge pipe placed in the tank. The instructions „Bleeding Air from the Fuel System“ must be read after initial operation or after it has stood still for a long

period, in order to preserve the starter battery.

Non-return valve for the fuel return pipe

If the fuel tank should be installed over the level of the generator (e.g. daily tank), then a non-return valve must be installed into the fuel return pipe to guarantee that through the return pipe no fuel is led into the injection pump.

ATTENTION!



5.9.3 Position of the pre-filter with water separator

Inside the generator capsule itself, there is the fuel filter installed (exception: Panda 4500). Additional fuel filters (with water separator) must be mounted outside the capsule in easily accessible places in the fuel lines between the tank intake fuel pump and the diesel motor's fuel pump.

Additionally to the standard fine filter a pre-filter with water separator must be installed outside of the sound insulation capsule in the fuel system line (not included in the delivery).

representative picture

Fig. 5.9.3-1: Pre-filter with water separator



5.10 Ventilating the fuel system

Normally, the fuel system is designed to ventilate air itself i.e. as soon as the electric starter motor starts operation the fuel pump starts working and the fuel system will be de-aerated after some time automatically. It is nevertheless essential to ventilate the system as follows prior to the first operation (as all hoses are empty):

Start the fuel pump

The external fuel pump can be started manual by an option in the iControl2 panel. See iControl2 manual for details. **Note:**



Ventilation Screw

4.) Open the ventilation screw located at the fuel solenoid valve. The „START“ button must continue to be pressed, whilst opening the screw. A large cloth or Kleenex tissue must be laid beneath the connection to prevent escaping fuel running into the capsule. If the fuel runs out without air bubbles, then the ventilation screw can be closed. Only then may the „START“ button be released.

5.) Switch the panel „OFF“.

This procedure must be repeated several times, until fuel (nonporously) withdraws perfectly at the ventilation screw.

Injection nozzles

Pressing the starter button can now start the machine. The machine should start after a short period.

If this does not occur, then a connecting nut fitted to the injection line must be loosened and starting procedure repeated. Retighten the washers after successfully starting. The injection line must be raised by several millimetres.

Switch main switch "OFF"

5.11 Generator DC system installation

The Panda 5000i.Neo has no DC alternator to charge the Starter battery. The Starter battery must be charged by an external device. **Note:**



It is recommended to install an additional starter battery for the generator.

The generator is then independent from the remaining battery set. This enables you to start the genset at any time with its own starter battery even if the other batteries are discharged. A further advantage of a separate starter battery is that it isolates the generator's electric system from the rest of the boat's DC system, i.e. minus pole (-) is not connected electrically to Earth/Ground.

The generator is then Earth/Ground free.

5.11.1 Connection of the starter battery block

An own separate starter battery must be installed for the generator.

The positive cable (+) of the battery is attached directly at the solenoid switch of the starter motor (position 1). The negative cable (-) of the battery is attached underneath the starter motor at the engine mount (position 2).

Make sure that the voltage of the starter battery fits to the start system voltage

f.e. 12 V starter battery for a 12 V start system

f.e. 24 V starter battery for a 24 V start system (2x12 V batteries in a row)

To avoid large voltage drops the battery should be installed as near as possible to the generator. The positive terminal of the battery is attached at the red cable, the negative pole at the blue cable.

It must be guaranteed that first the cables are attached at the generator and then at the battery.

Battery connection

Wrong connection of the battery bank can cause a short-circuit and fire.

Install an appropriate fuse and a battery circuit breaker in the plus pole cable of the battery, but with a distance to the battery of up to 300 mm (12 inch) at maximum.

The cable from the battery to the safety device must be secured with protective pipe/sleeve against chafing through.

For the connection use self-extinguishing and fire-protected cables, which are appropriate for temperatures up to 90 °C, 195 °F.

The batteries must be installed in such a way that they do not chafe through or other mechanical load can be stripped.

The battery poles must be secured against unintentional short-circuit.

The positive battery cable within the generator must be shifted in such a way that it is protected against heat and vibrations by appropriate sleeve/protective pipe. It must be shifted in such a way that it does not affect rotary parts or parts, that become hot in operation, e.g. wheel, exhaust elbow union, tail pipe and the engine. Do not lay the cable too tautly, since otherwise it could be damaged.

Make a test run after the installation and check the laying of the batteries during the test run and afterwards. If necessary, correct the laying.

Examine regularly the cable laying and the electrical connections.

DC Starter Motor

All Panda generators are equipped with an independent DC starter motor.

1. Solenoid switch for starter motor
2. Starter motor

ATTENTION!



NOTE:



Attention!: Consider correct connection sequence



Attention!: Right connection of the battery.



Fig. 5.11.1-1: DC Starter Motor

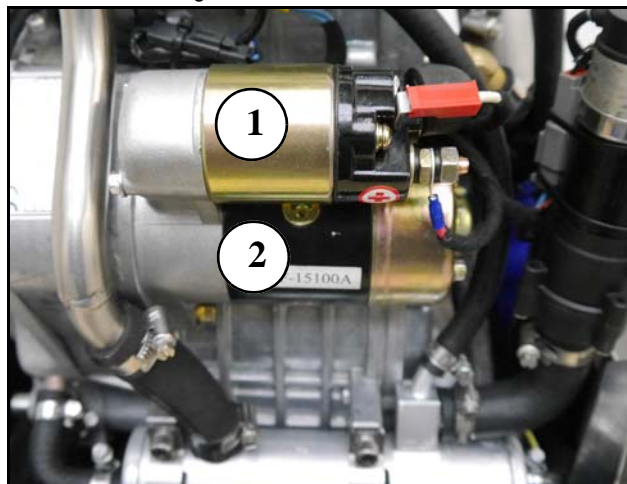

Positive battery cable

The positive (+) battery cable is connected directly to the solenoid switch of the starter.

Fig. 5.11.1-2: Positive Battery Cable

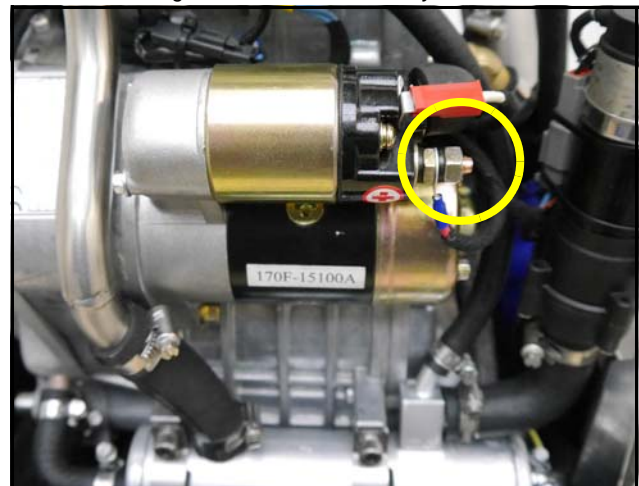

Negative battery cable

The negative (-) battery cable is connected to the engine foot.

Fig. 5.11.1-3: Negative Battery Cable

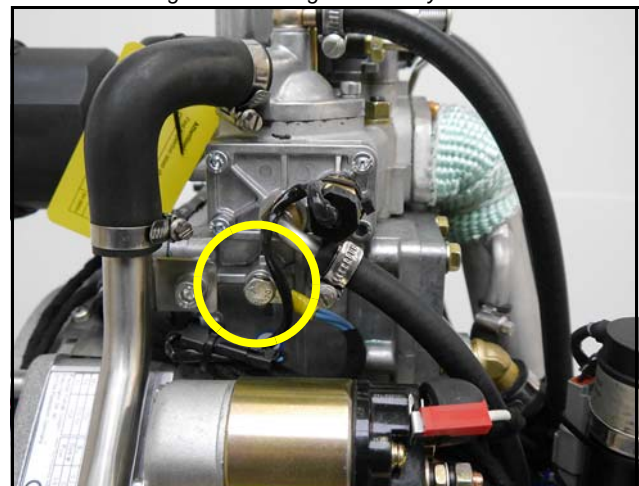

Note! The battery negative pole may not be connected with the boat ground.

Fig. 5.11.1-4: Connection starterbattery 12V - schema

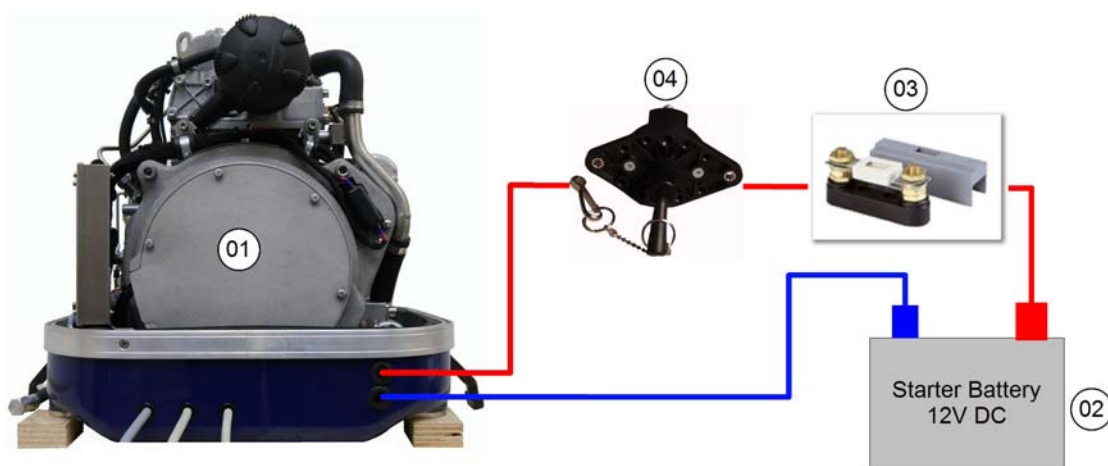

- 1. Generator
- 2. Battery block

- 3. Fuse
- 4. Battery main switch

5.12 Generator AC System Installation

Before the electrical system is installed, READ the SAFETY INSTRUCTIONS of this manual FIRST! Be sure that all electrical installations (including all safety systems) comply with all required regulations of the regional authorities. This includes lightning conductor, personal protection switch etc.

ATTENTION!



All electrical safety installations have to be made on board.

Required cable cross-sections

The following recommended electrical cable dimensions (cross sections) are the minimum required sizes for a safe installation (see "Diameter of conduits" on Page 79).

Fig. 5.12-1: Electrical installation - example

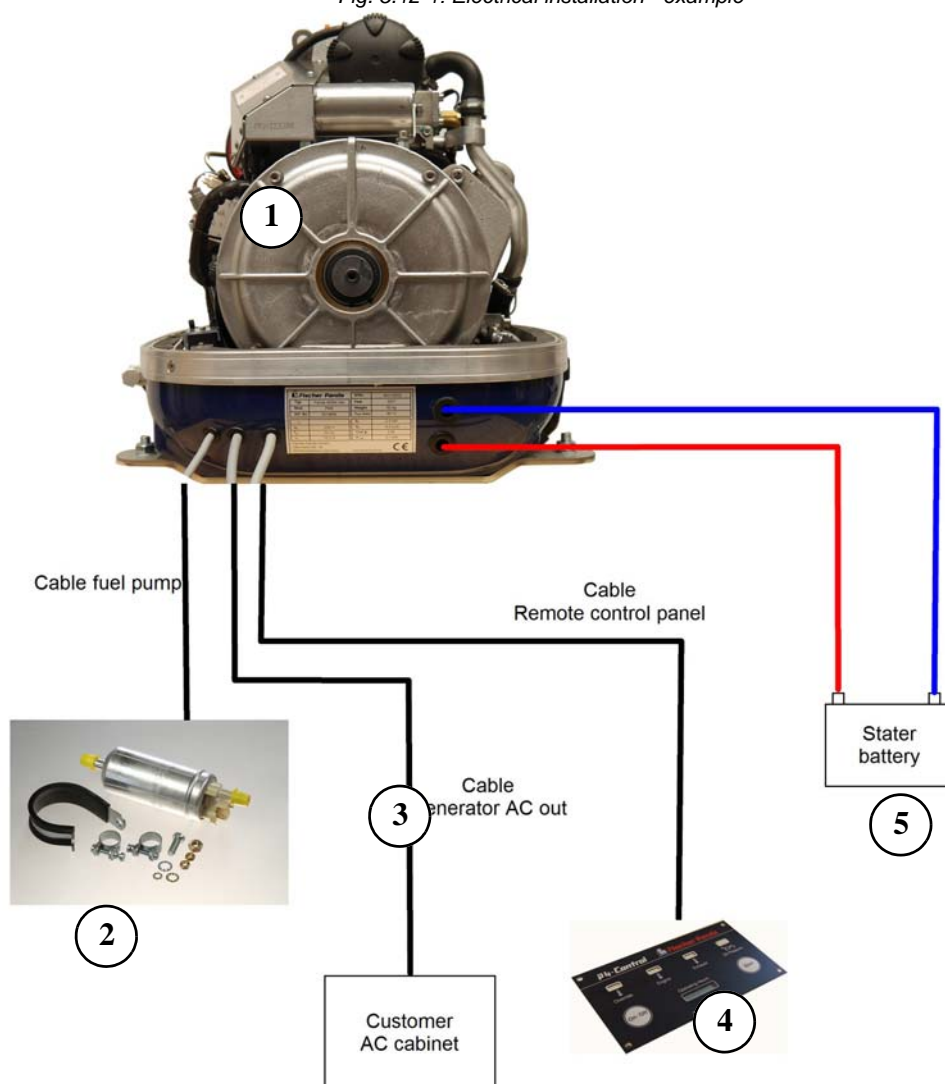

- 1. Generator
- 2. Electrical fuel pump DC
- 3. Generator AC out

- 4. Remote control panel
- 5. Starter battery DC

5.12.1 Power source selector

A power source selector switch must be installed between the PMGi power out and the ship's electrical supply system. This switch must be used to ensure that all AC consumers can be switched off at once. This switch should also be installed to keep the generator and shore (grid) power systems separate.

3-Way Cam Switch

A 3-way cam switch should be used. This switch basic positions: „Shore power“ - „OFF“ - „Generator“. If an (DC-AC) inverter is used, a fourth position will be required.

0. OFF

I. Generator

II. Shore power connection

III. Inverter

Fig. 5.12.1-1: 3-Way Cam Switch

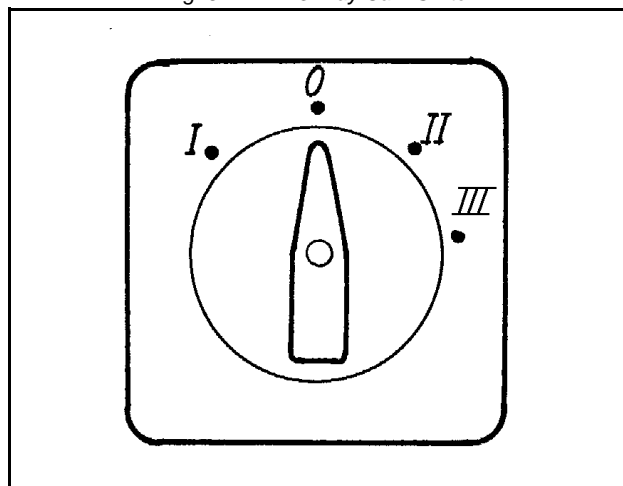

The cam-type switch must have 2 poles, so that „MP“ and „phase“ can be switched off.

If a 3-phase current system is also installed with the option of supplying from either the generator or shore power, an additional switch must be installed to keep these systems separate.

An alternative to a manual rotating switch is an automatic power relay. When the generator is not running, the relay remains in the shore power position. As soon as the generator is running, the power relay switches automatically to the generator position.

Note: If the system has both single and 3-phase AC, it is CRITICAL that the two systems remain SEPARATE!

Protection conductor

The generator is provided with a PEN safety system, as standard, which connects the 3-phase delta centre point „N“ to the safety ground strap.

If a separate ground protection cable is necessary (i.e. due to national safety regulations), the bridge between the generator housing and ground (in the AC-Control box) must be disconnected. Once such a ground protection cable is installed, it must be connected to the ground straps of all on board electrical devices.

In order to monitor the electrical system, it is recommended to install a voltmeter (and, if possible, a current meter) down line from the power source selector switch so that all respective power sources can be monitored. A separate voltmeter for the generator, itself, is therefore not required.

Electrical fuses

It is absolutely essential that the electrical system installation is inspected by a qualified electrical technician. The generator should have its own AC input electrical fuses. The fuses should be sized such that the rated current of the generator on each of the individual phases is not exceeded by more than 25%.

Data for gensets with power output greater than 30 kW on request!

The fuses must be of the slow type. A 3-way motor protection switch must be installed to protect the electrical motor.

Required fuses see Tabelle 7.1, „Diameter of conduits,“ auf Seite 79

Required cable cross-sections

The following recommended electrical cable dimensions (cross sections) are the minimum required sizes for a safe installation. (siehe Tabelle 7.1, „Diameter of conduits,“ auf Seite 79)

5.13 Checking and filling of the oil circuit

Check oil and fill the oil circuit as described in the service chapter.

5.14 Isolation test

After installation, before bringing into service and handover of the generator to the customer, an isolation test has to be accomplished as follows:

ATTENTION!



1. Switch off all electrical load.
2. Start the generator.
3. Measure the AC-voltage with a voltmeter (adjust to Volt/AC) between:
 - a) generator housing and AC-Control box
 - b) generator housing and ground.

The measured voltage must not exceed 50 mV (millivolt).

4. Once the safety systems have been installed, they must be checked. If a leakage current relay (RCD) has been installed, it also has to be tested in order to ensure that all contacts are connected properly. The individual phases have to be checked against each other, and between phase and ground. An additional 4th phase (L1') also needs to be checked at generators with DVS winding.
5. If the generator is protected by a ground connection, it has to be ensured that ALL electrical devices must also be connected to this „common“ ground (usually ground contacts are attached to the device's metallic housing).

The electrical system installation must also comply with the hook-up requirements of the shore current grid. Generally a leakage current relay (RCD) is sufficient for safe electrical operation; however, this must be confirmed by the electrical safety standard in the region where the system is attached to a main land power grid. The release current of the relay (RCD) has to meet the installation circumstances.

5.15 Initial operation

After successful installation an initial operation has to be performed.

For this purpose the initial operation record has to be completely filled out by the installing expert. The filled record has to be handed out to the owner.

The owner has to be instructed regarding handling, servicing and risks of the generator. This applies to the service steps and risks mentioned in the manual as well as further risks which may arise from the specific installation and the connected components.

The original initial operation record has to be sent to Fischer Panda to receive the complete guarantee. Please make a copy for your own documentation.

Note:



6. Maintenance Instructions

6.1 Personal requirements

All maintenance work - if not specially marked - can be made by the trained persons.

Further maintenance work must only be made by Technical personel or Fischer Panda service points.

6.2 Personal requirements

All maintenance, if not special marked, can be done by the trained persons.

Further maintenance must be done by technical personal or Fischer Panda service points.

6.3 Hazard notes for the maintenance and failure

Follow the general safety instruction at the front of this manual.

Notice!:



Danger for life! - The generator can be equipped with a automatic start device. This means the generator can be started by an external signal. To avoid an unexpected starting of the generator, the starter battery must be disconnected before start working at the generator.

Warning!: Automatic start



Working at a running generator can result in severe personal injury. Therefore before starting work at the generator:

Warning!: Risk of injury



Make sure that the generator is stopped and the starter battery is disconnected to guarantee that the generator cannot be inadvertently started.

Do not run the generator with removed sound isolation cover

Improper installation/maintenance can result in severe personal injuries or material damage.

Warning!: Risk of injury



- Always undertake installation/maintenance work when the generator is switched off.
- Ensure there is sufficient installation clearance before start working.
- Ensure tidiness and cleanliness at the workplace. Loose components and tools lying around or on top of each other are sources of accidents.
- Only perform installation work using commercially available tools and special tools. incorrect or damaged tools can result injuries.

Oil and fuel vapours can ignite on contact with ignition sources. Therefore:

- No open flames during work on the generator.
- Do not smoke.
- Remove oil and fuel residues from the generator and floor.

Contact with engine oil, antifreeze and fuel can result in damage to health. Therefor:

- Avoid skin contact with engine oil, fuel and antifreeze.
- Remove oil and fuel splashes and antifreeze from the skin immediately.
- Do not inhale oil and fuel vapours.

Danger for Life. Improper handling, operation, installation and maintenance can result in severe personal injury and/or material damage.

Electrical voltages above 60 volts are always dangerous to life). The rules of the respective regional authority must be adhered to. Only an electrician may carry out installation of the electrical connections for safety reasons.

Generator, oil and antifreeze can be hot during/after operation. Risk of severe burns.

During Installation/maintenance personal protective equipment is required to minimize the health hazards.

- Protective clothing
- safety boots
- protective gloves
- Ear defender
- safety glasses

Disconnect all load during the work at the generator to avoid damages at the load.

Batteries contains acid or alkalis.

Improper handling can result in battery explosion and leakage. Acid or alkalis can run out. An explosion of the battery is possible.

See the operation and safety instruction from your battery manufacturer.

Batteries contain corrosive acids and lyes.

Improper handling can cause the batteries to heat up and burst. Corrosive acid/lye may leak. Under unfavorable conditions, the battery may explode.

Warning!: Danger of fire



Danger!: Danger of poisoning



ATTENTION!: Danger to Life - High voltage



Warning!: Hot surface/material



Instruction!: Personal protective equipment necessary.



Attention!: disconnect all load



Warning!:



Observe the instructions from your battery manufacturer.

6.4 Environmental protection

Danger to the environment due to mishandling!

Environmental protection.

Significant environmental damage can occur, particularly for incorrect disposal, if environmentally hazardous operating materials are mishandled. Therefore:



- Always observe the instructions mentioned below.
- Take immediate action if environmentally hazardous materials reach the environment. Inform the responsible local authorities about the damage in the case of doubt.

The disposal must be performed by a specialist disposal company.

6.5 General maintenance instructions

6.5.1 Maintenance parts

Fig. 6.5.1-1: Maintenance Parts

| FP Art No. | Maintenance Part |
|------------|---|
| 0015567 | Valve Cover Gasket |
| 0015560 | Air Filter Fischer Panda G1 |
| 0000651 | Impeller set for pump F35B with O-seal and gasket |
| 0003990 | Fuel in line filter 8mm plastic housing |
| 0004666 | Oil Filter for FP-320 |

Fig. 6.5.1-2: Maintenance Kits

| Art No 0015691 | Service Kit PMS NEO (standard kit for 150h service) | Qty |
|----------------|---|-----|
| 0015567 | Valve Cover Gasket | 1 |
| 0004666 | Oil Filter for FP-320 | 1 |
| 0003990 | Fuel in line filter 8mm plastic housing | 1 |
| 0015560 | Air Filter Fischer Panda G1 | 1 |
| 0000651 | Impeller set for pump F35B with O-seal and gasket | 1 |
| | Storage box | |

| Art No | Service Kit Plus PMS NEO (advanced kit for 4x 150h service) | Qty |
|---------|---|-----|
| 0015567 | Valve Cover Gasket | 4 |
| 0004666 | Oil Filter for FP-320 | 5 |
| 0003990 | Fuel in line filter 8mm plastic housing | 4 |
| 0015560 | Air Filter Fischer Panda G1 | 4 |
| 0000651 | Impeller set for pump F35B with O-seal and gasket | 2 |
| 0000650 | Service Kit for F35B-8 | 1 |
| 0003675 | Fuse strip DIN 72581/2 030A, 41x11 mm | 3 |
| | Storage box | |

6.5.2 Checks before each start

- Oil level
- Leaks in the Cooling system
- Visual check for any changes, leaks in the oil drain system, v-belt, cable connections, hose clips, air filter, fuel lines

6.6 Maintenance interval

For the maintenance interval, please see the „General information for PMS generators“ which are attached to this manual.

At generator with dynamic operation hours (f.e. Generators with iControl2 system) the maintenance interval can may be extended.

With the dynamic operation hours the service interval can be raised up to 30 % (200 h max.). Make sure that the dynamic operation hours are not reset accidently between the service interval.

Note:



6.6.1 Check of Hoses and Rubber Parts in the sound insulated capsule

Check all hoses and hose connections for good condition. The rubber hoses are very sensitive to environmental influences. They wear out quickly in an environment of dry air, oil and fuel vapours, and high temperatures. The hoses must be checked regularly for elasticity. There are operating situations, when hoses must be renewed once a year.

Additionally to usual tasks of maintenance (oil level check, oil filter control etc.) further maintenance activities are to be accomplished for marine generators, such as the front seal cover at the generator.

6.7 Oil Change Intervals

The first oil change is to be accomplished after a period of operation from 35 to 50 hours. Afterwards the oil is to be changed after 150 hours. For this, the oil SAE30 for temperatures over 20°C and SAE20 for temperatures between 5°C and 20°C is to be used. At temperatures under 5°C oil of the viscosity SAE10W or 10W-30 is prescribed.

For filling quantity, see „Technical Data“ at page 107.

6.8 Checking oil-level

You require:

paper towels / cloth for the oil dipstick

The generator must be placed at level.

- with marine generators: Measure the oil-level when the ship is not lop-sided.

Generator, coolant and engine oil can be hot during and after operating. **Caution: Burn hazard!**



Wear personal protective equipment. (Gloves, protective goggles, protective clothing and safety shoes)

- Assure generator against accidental start.

- Open the generator casing.
- Screw the oil dipstick out of the check rail.
- Clean oil dipstick.
- Put the oil dipstick back into the check rail, do not screw it in and wait for 10 seconds.

Fig. 6.8-1: Oil dipstick



- Pull the oil dipstick out of the check rail and read off the oil-level at the lower end of the stick.

Oil dipstick FP320 Engine

The oil-level is to be checked by means of the oil dipstick. The prescribed filling level must not cross the „Max“-mark.

We recommend an oil-level of 90%.

Fig. 6.8-2: Oil dipstick

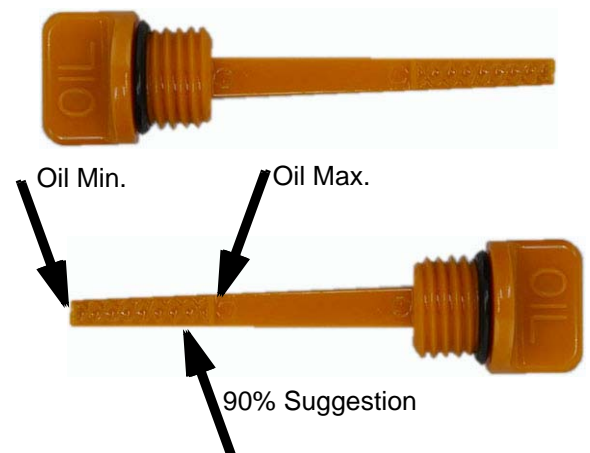

Oil should be refilled, if the oil-level is under 50% between the minimum and the maximum mark.

Fischer Panda recommends an oil-level of 90% between the minimum and the maximum mark.

If the oil-level is under the MIN-mark, check how many operating hours went by since the last oil change, by means of your service manual or an existing oil change tag. - with operating hours between 50 and 150 hours it is only necessary to refill oil. See „Refilling oil“ on page 2.

- with 150 operating hours or more the oil should be changed (See your generators' service table)
- if the oil-level is under the minimum mark by less than 50h, there might be a technical problem! In that case, we recommend going to a shop or a Fischer Panda service point.
- if the oil is cloudy or even „creamy“, coolant might have mixed with the oil. See a garage or a Fischer Panda service point immediately.

6.8.1 Refilling oil

You require:

Engine oil

1. Check oil-level as described under section 6.8, “Checking oil-level,” on page 68.
2. Oil dipstick is pulled out of the check rail.
3. Open the oil filler cap.
4. Fill in oil (approx. 0,1 litre) and wait for about 2 min. so this it can flow into the oil pan.

5. Wipe off the oil dipstick and put it into the check rail.
6. Pull the oil dipstick out of the check rail and check the oil-level. See section 6.8, "Checking oil-level," on page 68. If oil-level is still too low (under 2/3): repeat steps 4-6.

6.8.2 After the oil level check and refilling the oil

- Screw the oil dipstick back into the check rail.
- Close the oil filling cap.
- Remove potential oil stains and splashes from the generator and surroundings.
- Close the generator casing.
- Remove lock against accidental generator start.

6.9 Replacement of engine oil and engine oil filter

You require:

- Engine oil. See attachment.
- New oil filter (not with generators with EA300 engines)
- Sealing for oil drain screw
- Personal protective gear
- Container to collect used oil (heat resistant and of sufficient size)
- Open-ended wrench for oil drain screw
- Paper towels and cloth
- Oil filter wrench
- Oil resistant mat, so prevent used oil from getting into underground water

The generator must be placed at level.

- with marine generators: Change the oil when the ship is not lop-sided.

Run the generator till the engine temperature reach 60°C to ensure that the engine is warm.

Generator and coolant can be hot during and after operating.

Caution: Burn hazard!

Wear personal protective equipment. (Gloves, protective goggles, protective clothing and safety shoes)



1. Prepare generator.
 - Assure generator against accidental start.
 - Open the generator casing.
 - Release the oil drain hose from the mounting.

Place an oil resistant mat under the oil drain hose area and prepare the container.

2. Loosen oil filling cap

Unscrew the oil filling cap. This is necessary, because otherwise a vacuum will form and the oil can not completely drain off.

Fig. 6.9-1: Oil filling cap



3. Open oil drain screw.

Unscrew the oil drain screw by means of the open-ended wrench from the oil drain hose (rotating direction left). Use a second open-ended wrench to lock. Make sure to do this over the container. Use spanner size 17 mm.

Fig. 6.9-2: Oil drain hose



4. Discharge used oil.

Let the entire amount of oil drain out of the engine. This can take several minutes.

5. Remove used oil filter / clean oil screen

Release the oil filter by turning the filter wrench counterclockwise. The filter might be full of oil. Make sure to not spill anything and avoid skin contact. Sample picture

Fig. 6.9-3: Oil filter



6. Preparing a new filter

Clean the engines' filter holder brush a thin oil layer on the sealing of the new filter.

Fig. 6.9-4: Oil screen sealing ring



7. Mounting the new filter

Carefully screw in the new filter by hand. It must not be tightened too much. Screw in the oil drain screw again and tighten it with the wrench. Use a new sealing for the oil drain screw.

8. Fill in oil. (oil fill capacity: see attachment)

Fill the engine oil into the engine via feed hopper. Check oil-level after every 0,75 litres with the oil dipstick.

9. Check proper filling level. See section 6.8, "Checking oil-level," on page 68.

When the proper filling level is reached, screw in the oil cap again. Run the engine for 10 minutes and then turn it off. Check the oil-level once more after several minutes with the oil dipstick. If it is too low, refill some oil.

10. Clean up

Wipe off all oil splashes from the generator and make sure that the drain screw has no leak.

6.9.1 After the oil change

- Screw the oil dipstick back into the check rail.
- Close the oil filling cap.
- Remove potential oil stains and splashes from the generator and surroundings.
- Close the generator casing.
- Remove lock against accidental generator start.
- Duly dispose of used oil and filter.

Used oil is very toxic and must not be disposed with domestic waste. It is prohibited to dispose used oil with waste water! Make sure that used oil is disposed properly (e.g.: where oil is bought or at collection stations).

6.10 Verifying the starter battery and (if necessary) the battery bank

Check the condition of the battery. Proceed here as prescribed by the battery manufacturer.

If from the battery manufacturer not otherwise mentioned.

6.10.1 Battery

6.10.1.1 Check battery and cable connections

- Keep battery clean and dry.
- Remove dirty clamps.
- Clean terminal posts (+ and -) and clamps of the battery, and grease with acid-free and acid-resistant grease.
- When reassembling, ensure that clamps make good contact. Tighten clamp bolts hand-tight.

Fig. 6.10.1.1-1: Battery

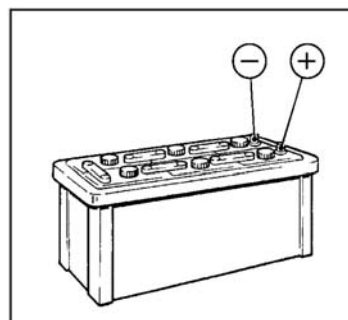

6.11 Checking the water separator in the fuel supply

The pre-filter with water separator has a cock underneath, by which means the water can be drained.

This water sinks to the bottom, due to the difference in the densities of water and fuel. Water is heavier than the diesel

Sample picture

Fig. 6.11-1: Pre-filter with water separator



6.11.1 Exchange of the Fuel Filter

Exchanging the filter, depending upon fuel contamination, should take place after 300 operational hours at the very least.

The inlet must be clamped, before exchanging the filter.

Remove the hoses from the used filter and fasten them to the new filter. The arrow on the filter housing indicates the direction of the fuel flow. A clogged filter causes a decreased power output of the generator.

Fig. 6.11.1-1: Fuel Filter



6.11.2 De-aerating the fuel system

Normally, the fuel system is designed to bleed out air itself i.e. as soon as the electric starter motor starts operation the fuel pump starts working and the fuel system will be de-aerated after some time automatically. It is nevertheless essential to bleed the system as follows prior to the first operation (as all hoses are empty) and after a fuel filter replacement:

1. Put a container under the fuel return pipe to catch running out fuel to catch.

Fig. 6.11.2-1: Fuel return pipe

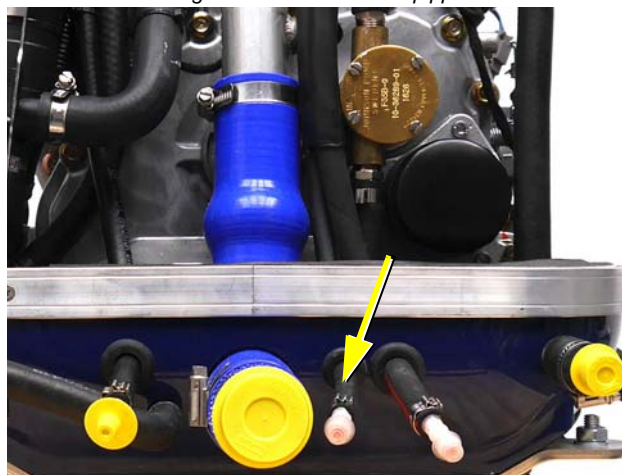

2. Switch the panel „ON“.
3. Activate the the fuel pump prime function in the panel menu.
4. Let the pump run till the fuel runs bleed free out of the return line. (about three times activation of the fuel pump prime function)

This procedure must be repeated several times, until fuel (nonporously) withdraws perfectly at the fuel return pipe.

Fig. 6.11.2-2: iControl

5. Switch the panel „OFF“.

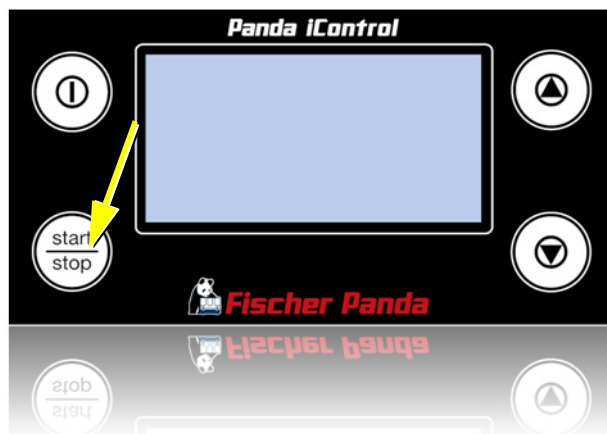

6.11.3 Replacement of the air filter

Open the air suction housing by turning the cap about 20° anti clockwise. Remove the cap.

Fig. 6.11.3-1: Air filter

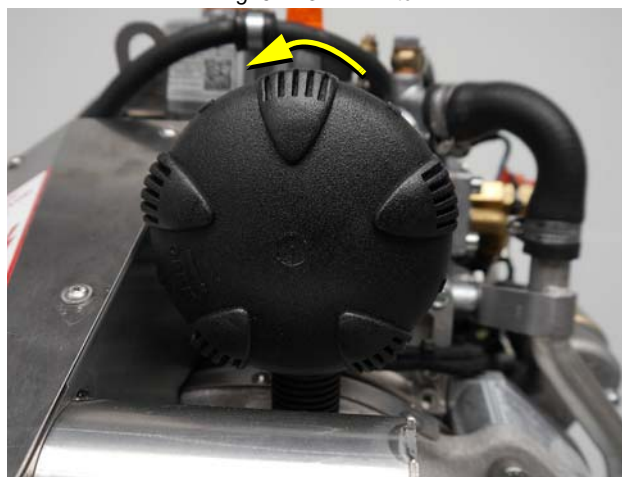

Remove the air filter.

Clean the air filter housing.

Replace the air filter and close the cover again.

Fig. 6.11.3-2: Air filter

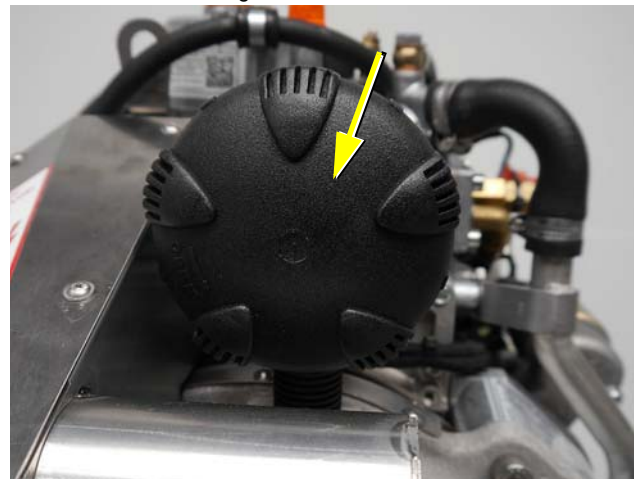

6.12 De-aerating of the coolant circuit / freshwater

The Panda 4000s PMS is self de-aerating.

6.13 The raw water circuit

6.13.1 Clean raw water filter

The raw water filter should be released regularly from arrears. In each case the water cock must be closed before. It is mostly sufficient to beat the filter punnet.

If water should seep through the cover of the raw water filter, this may be sealed in no case with adhesive or sealant. Rather must be searched for the cause for the leakage. In the simplest case the sealing ring between caps and filter holders must be exchanged.



Fig. 6.13.1-1: Raw water filter

6.13.2 Causes with frequent impeller waste

The impeller of the cooling water pump must be regarded as wearing part. The life span of the impeller can be extremely different and exclusively depends on the operating conditions. The cooling water pumps of the PANDA generators are laid out in such a way that the number of revolutions of the pump lies low compared with other aggregates. This is for the life span of the pump a positive effect.

Unfavorably affects the life span of the impeller, if the cooling water sucking in way is relatively long or the supply is handicapped, so that the cooling water sucking in range develops a negative pressure. This can reduce first of all the power of the cooling water pump extremely that the wings of the impeller are exposed to very strong loads. This

can shorten the life span extremely.

Further the operation of the impeller pump loaded in waters with a high portion of suspended matters. The use of the impeller pump is particularly critical in coral waterbodies. Cases are well-known, which a impeller pump had so strongly run after 100 hours already that the lip seal on the wave was ground in. In these cases sharp crystal parts of the coral sand assess in the rubber seal and affect like an abrasive the high-grade steel shank of the impeller pump.

If the generator were mounted over the water level it is particularly unfavorable for the impeller pump. After the first start some seconds will pass by, until the impeller can suck in cooling water. This short unlubricated operation time damages the impeller. The increased wear can lead after short time to the loss. (see special notes: "Effects on the impeller pump, if the generator is mounted over the waterline").

6.13.3 Replacement of the impeller

Close the raw water stop cock.

Fig. 6.13.3-1: Raw water stop cock

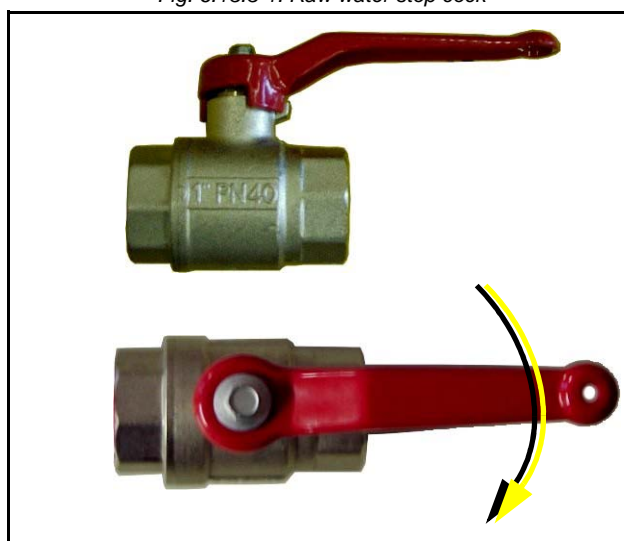

Raw water pump on the front side of the genset.

Fig. 6.13.3-2: Raw water pump



Remove the cover of the raw water pump by loosen the wing screws from the housing.

Fig. 6.13.3-3: Raw water pump

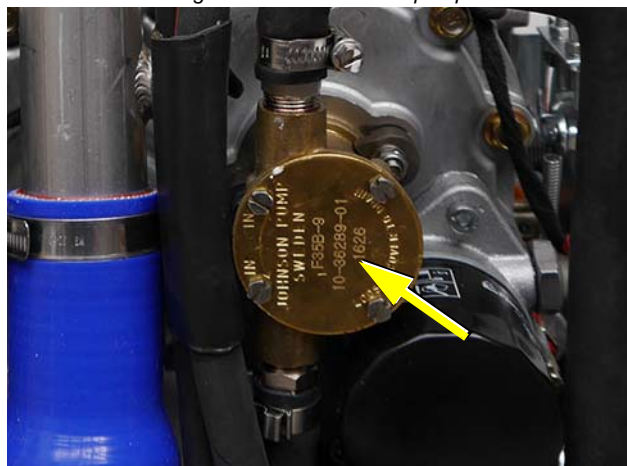

Pull to the impeller with a multigrip pliers of the wave.

Mark the impeller, to make sure that these is used in the correct position at re-installation.



Fig. 6.13.3-4: Impeller

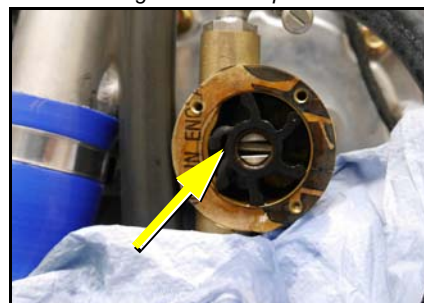

Check to the impeller for damage and replace it if necessary.

Before the reinsertion into the housing the impeller should have been lubricated with glycerin or with a non-mineral oil based lubricant e.g. silicone spray.

Fig. 6.13.3-5: Impeller



The impeller is attached to the pump wave (if the old impeller is used, pay attention to the before attached marking).

Fastening the cover and use a new seal.

Fig. 6.13.3-6: Impeller seal



7. Generator Tables

7.1 Diameter of conduits

Fig. 7.1-1: Diameter of conduits

| Generator type | Ø Cooling water pipe | Ø Cooling water pipe external expansion tank | Ø Exhaust hose [mm] | Ø Fuel hose | |
|-----------------|----------------------|--|---------------------|-------------|-------------|
| | Raw water [mm] | Feed /Bleeding [mm] | | Supply [mm] | Return [mm] |
| Panda 4000s PMS | 20 | 10/8 | 40 | 8 | 8 |

7.2 Technical Data

Fig. 7.2-1: Technical Data generator

| | Panda 5000i.Neo | Panda 4000S.Neo | |
|---|---|---|--|
| Type | FPE-320 | FPE-320 | |
| Rpm control | I Control 2 | mecanical | |
| Automatik Startbooster | no | no | |
| Cylinder | 1 | 1 | |
| Bore | 78 mm | 78 mm | |
| Stroke | 64 mm | 64 mm | |
| Stroke volume | 309 cm ³ | 309 cm ³ | |
| max. Power | 4,0 kW @3250 rpm | 3,4 kW @3000 rpm | |
| Rated speed | 3250 rpm | 3100 rpm | |
| Idle speed running | 2500 rpm | 2850 rpm | |
| Valve clearance (engine cold) | in:0,15 ; ex: 0,15 | in:0,15 ; ex: 0,15 | |
| Lubrication oil capacity | 2,1l | 2,1l | |
| Fuel consumption | on request | - | |
| Oil consumption | max. 1 % of Fuel consumption | | |
| Lubrication oil spezifikation | SAE 15W-40 ACEA A3/B3 recommend: Castrol GTX | SAE 15W-40 ACEA A3/B3 recommend: Castrol GTX | |
| Cooling water requirement for seawater circuit (Marine generators only) | ca. 13 l/min | ca. 13 l/min | |
| Permissible max. permanent tilt of engine | a) 20° gegen die Motorachse b) 20° in der Motorachse | | |
| Recommend starter battery size | 12 V 55 Ah | 12 V 55 Ah | |
| Recommend cable cross size starter battery cable Length 4 meter max. | Min 35 mm ² recommend 55mm ² | Min 35 mm ² recommend 55mm ² | |

7.3 Types of coil

HP3 delta connection

Fig. 7.3-1: HP3 delta connection

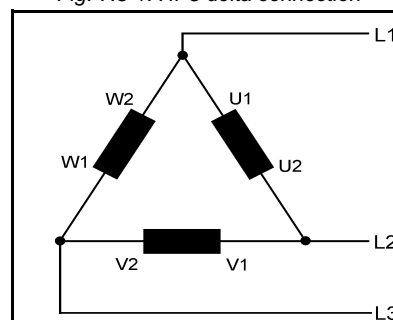

7.4 Engine oil

7.4.1 Engine oil classification

Full mineral engine oil SAE15W-40 ACEA A3/B3

Fischer Panda recommend Castrol GTX

7.5 Fuel

Use a clean Diesel fuel oil according to DIN590:1999 or better. For Generators with common rail or particle filter use DIN590:2009 or better.

Do not use alternative fuel, because its quality is unknown or it may be inferior in quality. Kerosene, which is very low in cetane rating, adversely effects the engine.

7.6 Coolant specifications

Use a mixture of water and antifreeze. The antifreeze needs to be suitable for aluminium. The antifreeze concentration must be regularly checked in the interests of safety.

Fischer Panda recommend to use the product: GLYSANTIN PROTECT PLUS/G 48

| Engine coolant automotive industry Product description | | |
|--|-----------------------------------|---------------------------------|
| Product name | GLYSANTIN ® PROTECT PLUS / G48 | |
| Chemical nature | Monoethylenglycol with inhibitors | |
| Physical form | Liquid | |
| Chemical and physical properties | | |
| Reserve alkalinity of 10ml | ASTM D 1121 | 13 – 15 ml HCl 01 mol/l |
| Density, 20 °C | DIN 51 757 procedure 4 | 1,121 – 1,123 g/cm ³ |
| Water content | DIN 51 777 part 1 | max. 3,5 % |
| pH-value undiluted | | 7,1 – 7,3 |

7.6.1 Coolant mixture ratio

| Water/antifreeze | Temperature |
|------------------|-------------|
| 70:30 | -20 °C |
| 65:35 | -25 °C |
| 60:40 | -30 °C |
| 55:45 | -35 °C |
| 50:50 | -40 °C |

8. Remote Control Panel P4 Control



| | | |
|--|---------|---------------------------------|
|  Fischer Panda | Art Nr. | 0000522 |
|  Fischer Panda | Bez. | Remote Control Panel P4 Control |

Tabelle 1:

| | Dokument | Hardware | Software |
|----------|----------|----------|----------|
| Aktuell: | R03 | V1.00 | ----- |
| Ersetzt: | R02.1 | V1.00 | ----- |

8.1 Remote control panel

Remote control panel P4 Control

The remote control panel is necessary to control the generator and to evaluate the motor/generator properties. The generators will automatically cutout, if it does not run as required. The generator may not be run without the remote control panel.

Fig. 8.1-1: Remote control panel



8.1.1 Cleaning and Replacing parts at the generator

Disconnect the battery when working on the generator

The battery must always be disconnected (first negative then positive pole), when work on the generator or the electrical system of the generator are made, so that the generator can not be started accidentally.

This is especially true for systems with an automatic start function. The automatic start function is to be deactivated before the work.

Sea valve must be closed. (only PMS version)

Note also the safety of the other components of your system.

**Generator, oil and antifreeze can be hot during/after operation.
Risk of severe burns.**

Attention!:



Note!:

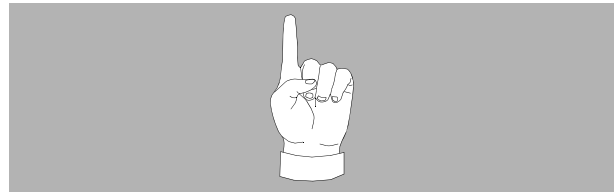

Warning!: Hot surface/material



8.2 Front side

Fig. 8.2-1: Remote Control Panel - Front Side

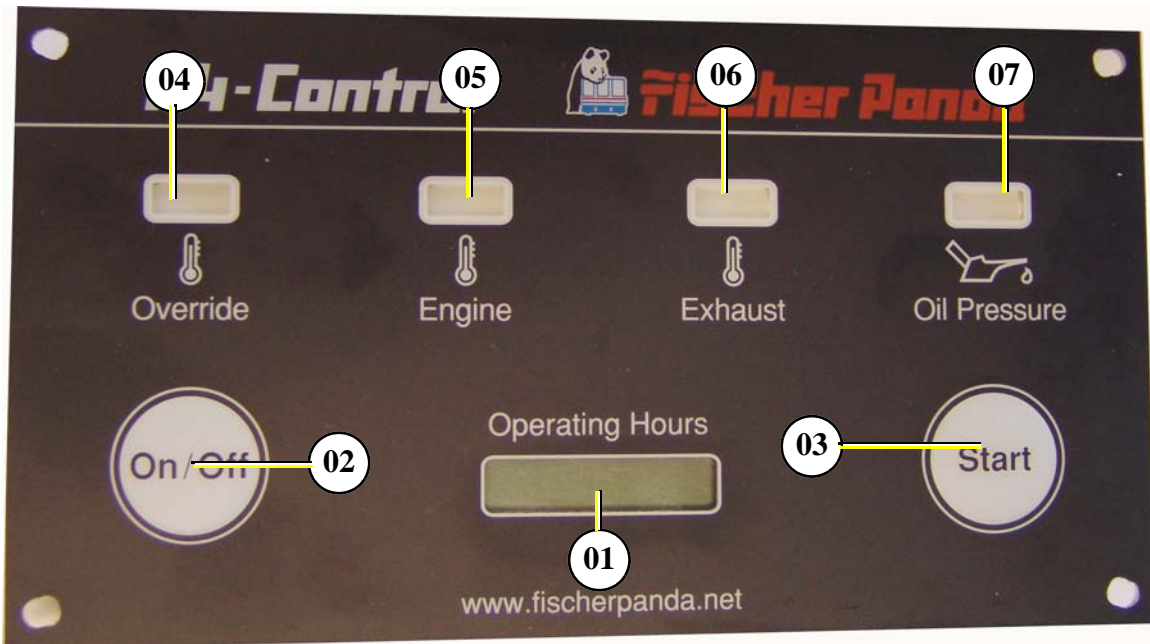

- | | |
|------------------------------|---|
| 01) Display operating hours | 05) Warning light for engine temperature |
| 02) Power „ON/OFF“-button | 06) Warning light for exhaust temperature |
| 03) Generator „Start“-button | 07) Warning light for oil pressure |
| 04) Control light „Override“ | |

8.2.1 Back side

Fig. 8.2.1-1: Remote control panel - back side

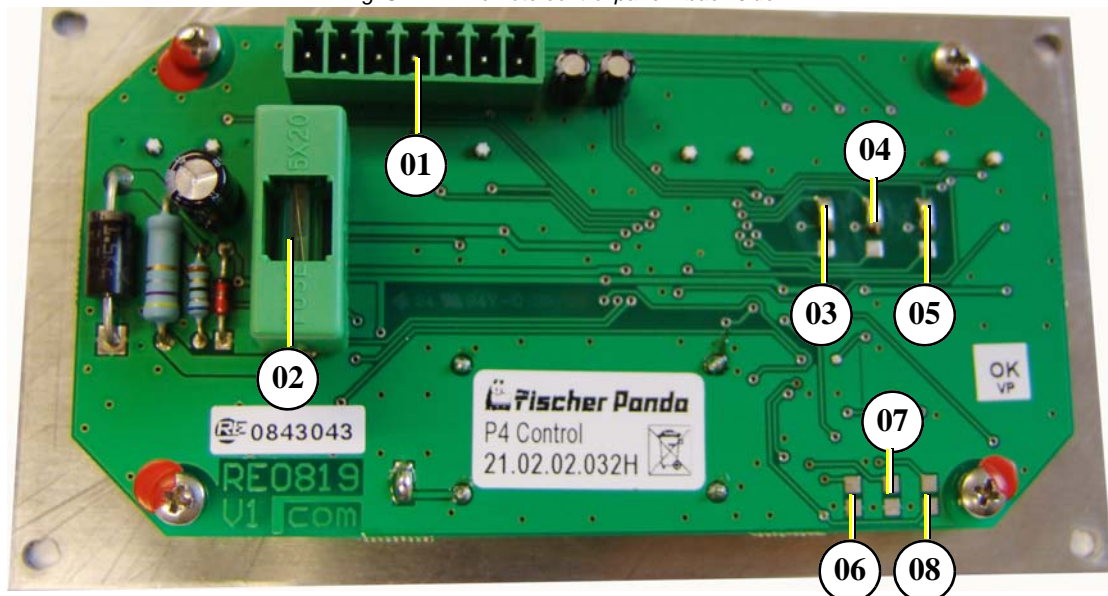

- | | |
|-----------------------------------|-----------------|
| 01) Connector for generator cable | 05) Jumper J101 |
| 02) Fuse 0,5A | 06) Jumper J104 |
| 03) Jumper J103 | 07) Jumper J105 |
| 04) Jumper J102 | 08) Jumper J106 |

8.3 Operation manual

8.3.1 Preliminary remarks

Advices concerning the starter battery

Fischer Panda recommends normal starter battery use. If a genset is required for extreme winter conditions, then the starter battery capacity should be doubled. It is recommended that the starter battery be regularly charged by a suitable battery-charging device (i.e., at least every 2 months). A correctly charged starter battery is necessary for low temperatures.

8.3.2 Override function

Depending on the installation situation, a heat accumulation inside the generator sound insulated capsule may occur (especially after longer run time with high load). According to this situation the engine overheat switch release after the generator has already stopped. The generator can not be started until the engine has cooled down.

To prevent this, the P4 Control panel has an override mode. While the start button is pressed and several seconds after it (can be modified with jumpers on the panel back side), the temperature error is ignored. The circulation of the cooling water cool down the engine and the generator can be started normal.

The control light „Override“ is turned on:

- if the panel is on and the generator is stopped (function control)
- during the „Start“ button is pressed (Override active)
- during the set time after the „Start button is released“ (Override active)

Not in use at the Panda 4000s series.

8.3.3 Daily routine checks before starting

1. Oil Level Control (ideal level: 2/3).

True, the diesel motor automatically switches off when there is a lack of oil, but it is very damaging for the motor, if the oil level drops to the lowest limit. Air can be sucked in suddenly when the boat rocks in heavy seas, if the oil level is at a minimum. This affects the grease in the bearings. It is therefore necessary to check the oil level daily before initially running the generator. The oil level must be topped up to the 2/3 level, if the level drops below the min. mark

Notice!: OIL PRESSURE CONTROL!

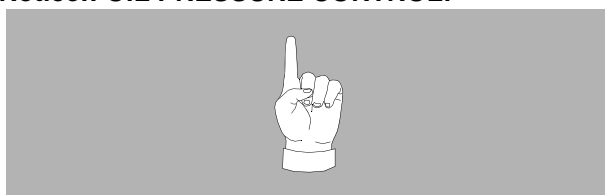

2. State of cooling water.

The external compensation tank should be filled up to a maximum of in a cold state. It is very important that large expansion area remains above the cooling water level.

3. Open sea cock for cooling water intake. (only Marine)

For safety reasons, the sea cock must be closed after the generator has been switched off. It should be re-opened before starting the generator.

4. Check raw water filter. (only Marine)

The raw water filter must be regularly checked and cleaned. The impeller fatigue increases, if residual affects the raw water intake.

5. Check all hose connections and hose clamps are leakage.

Leaks at hose connections must be immediately repaired, especially the raw water impeller pump. It is certainly possible that the raw water impeller pump will produce leaks, depending upon the situation. (This can be caused by sand particles in the raw water etc.) In this case, immediately exchange the pump, because the dripping water will

be sprayed by the belt pulley into the sound insulated casing and can quickly cause corrosion.

6. Check all electrical lead terminal contacts are firm.

This is especially the case with the temperature switch contacts, which automatically switch off the generator in case of faults. There is only safety if these systems are regularly checked, and these systems will protect the generator, when there is a fault.

7. Check the motor and generator mounting screws are tight.

The mounting screws must be checked regularly to ensure the generator is safe. A visual check of these screws must be made, when the oil level is checked.

8. Switch the land electricity/generator switch to zero before starting or switch off all the load. (only Marine)

The generator should only be started when all the load have been switched off. The excitation of the generator will be suppressed, if the generator is switched off with load connected, left for a while, or switched on with extra load, thus reducing the residual magnetism necessary for excitation of the generator to a minimum. In certain circumstances, this can lead to the generator being re-excited by means of a DC source. If the generator does not excite itself when starting, then excitation by means of DC must be carried out again.

9. Check the automatic controls functions and oil pressure.

Removing a cable end from the monitoring switch carries out this control test. The generator should then automatically switch off. Please adhere to the inspection timetable (see Checklist in the appendix).

8.3.4 Starting the generator

1. Open sea lock and close battery switch if necessary.
2. Push „ON/OFF“ button to switch panel on.
3. Push „Start/Stop“ button to start the generator.
4. Switch on load.

In the event of starting problems, close the sea water inlet cock. Panda marine generators only.

Should there be any reason to turn the engine (over) or start the engine i.e. to bleed the fuel system, the sea water inlet cock must be closed! During the starting process, the cooling water pump is driven with the motor. The cooling water is discharged to the exhaust outlet and, since the motor has not run, the exhaust pressure is not high enough to expel the sea water which has been brought to the exhaust outlet. To avoid filling the exhaust outlet with water and causing further problems, close the inlet sea water valve.

Once the engine is running, be sure to open the inlet valve!

Attention!:



8.3.5 Stopping the generator

1. Switch off load.
2. If the load is higher than 70 % of the nominal load, the generator temperatures should be stabilised by switching off the load for at least 5 minutes.

At higher ambient temperatures (more than 25 °C) the generator should always run for at least 5 minutes without load, before it is switched off, regardless of the load.

3. Press „OFF“ button and switch off the generator.
4. Activate additional switches (Battery switch, fuel stop valve etc.).

Never switch off the battery until the generator has stopped.

5. If necessary, close sea cock.

Notice!:

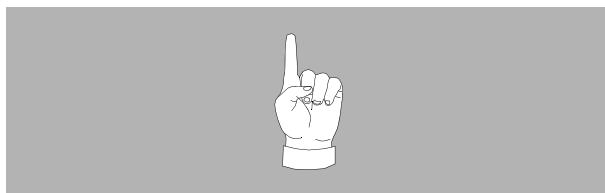

If the generator switches itself off with the operation with load for temperature reasons, must be examined immediately, which the cause is. That can be an error at the cooling system or any error in the range of the outside cooling system.

:Notice!:

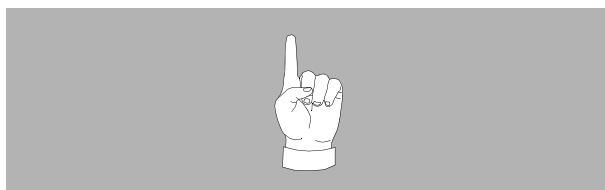

8.4 Installation of the panel

8.4.1 Connection of the remote control panel

As standard a 7 core connection-cable, 7m long, is included in the supply. Cores are numbered from 1 to 7. The control cables are securely connected to the genset. On the back of the control panel there are terminals numbered from 1 - 7. Connect the cores of the control-cable in respective order.

Please ensure that the remote control panel is installed in a protected, dry and easily accessible place.

Fig. 8.4.1-1: Remote control panel - back side

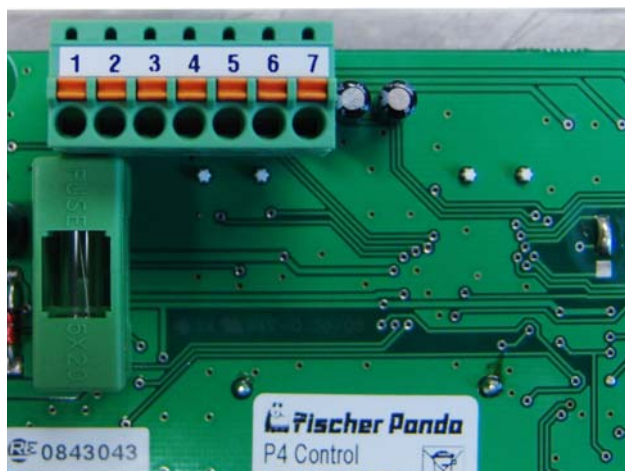

| Term.-No | Terminator.-name | i / o | Description |
|----------|------------------|-------|---|
| 1 | Vbat | i | Power supply 12 V (+) |
| 2 | GND | i | Power supply 12 V(-) |
| 3 | T-Cyl | i | <p>Error „engine temp“. Temperature switch engine head in.</p> <p>Can be set up by jumper as NC or NO</p> <p>Gives 22 mA (12 V +) on the switch.</p> <p>This error is ignored while the „Start“ button is pressed and several seconds after it is released (time set up by jumpers)</p> <p>The yellow „Override“ LED is on while the error is ignored.</p> <p>Status is displayed by green/red LED.</p> |

| | | | |
|---|-----------|---|---|
| 4 | T-EXH | i | Error „exhaust temp.“. Temperature switch exhaust elbow in. Can be set up by jumper as NC or NO Gives 22 mA (12 V +) on the switch. Status is displayed by green/red LED. |
| 5 | Oil-Press | i | Error „oil pressure“. Oil pressure switch in. Can be set up by jumper as NC or NO Gives 22 mA (12 V +) on the switch. Status is displayed by green/red LED. |
| 6 | Start | o | Start relay out . Is active while the „Start“ button is pressed. The supply voltage is switched on the relay. (see remarks 1-3) |
| 7 | Fuel-Pump | o | Fuel pump relay out. Is active, if no error (temp. or oil press. at 3, 4, 5) is applied. Is active during the „Override“. The supply voltage is switched on the relay. (see remarks 1-3) |

- 1) Max. current out continuous operation: 0,25 A short time 0,4 A
- 2) Max. current out is limited by the panel fuse (minus 0,1 A for the panel).
- 3) The out is protected by an freewheeling diode.

8.5 Jumper configuration

8.5.1 Jumper configuration for the input

8.5.1.1 Jumper J101-J103

Fig. 8.5.1.1-1: Jumper J101 - J103

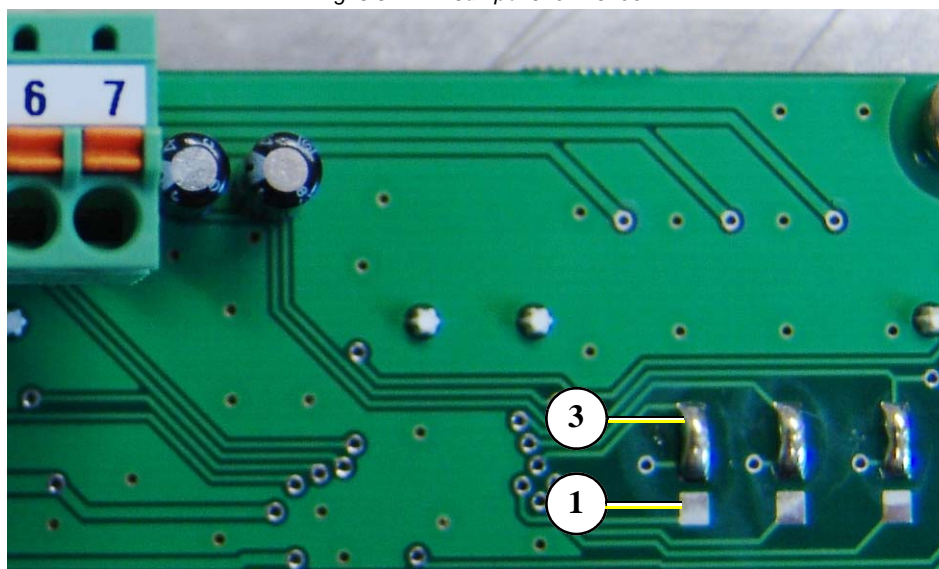

At the 3 pin jumpers J101-J103 the pin 3 is at the termination block side.

| Jumper | Status | Desc. |
|--------|--------|---------------------------------|
| J101 | 1-2 | Temp. switch engine head is NC |
| | 2-3 | Temp. switch engine head is NO |
| J102 | 1-2 | Temp switch exhaust elbow is NC |
| | 2-3 | Temp switch exhaust elbow is NO |
| J103 | 1-2 | Oil pressure switch is NC |
| | 2-3 | Oil pressure switch is NO |

8.5.2 Jumper for configuration of the „Override“ time

| | J104 | J105 | J106 | Test-Mode | Override time [s] |
|----------|-------------|-------------|---------------|------------|-------------------|
| 1 | open | open | open | no | 40 |
| 2 | closed | open | open | no | 20 |
| 3 | open | closed | open | no | 10 |
| 4 | closed | closed | open | no | 5 |
| 5 | open | open | closed | no | 0,16 |
| 6 | closed | open | closed | no | 0,08 |
| 7 | open | closed | closed | no | 0,04 |
| 8 | closed | closed | closed | no | 0,02 |
| 9 | open | open | -- | yes | 2,5 |
| 10 | closed | open | -- | yes | 1,25 |
| 11 | open | closed | -- | yes | 0,63 |
| 12 | closed | closed | -- | yes | 0,31 |

1 is standard for „override“ activated

2 is standard for „Override“ deactivated“

9 is standard for „Test mode“

The Test mode is active as long as the button „on/off“ is pressed by turning on the panel.

8.6 Maximum ratings

Operation outside of the maximum ratings can causes damage at the panel and the generator

In not indicated otherwise the ambient temperature is assumed. All voltage data are against GND (X1.2).

Operation voltage U_b is the voltage at terminator X1.1

| Parameter | Desc. | min. | max. | |
|-----------------------------------|--|------|-------|----|
| Operation Voltage | without time limit. full function | 10,5 | 15 | V |
| | without time limit, full function (except H-Meter, LED light lower) | 6 | | V |
| | maximal 60 min, $T_a = 65\text{ °C}$, full function | | 17 | V |
| | maximal 60 s, $T_a = 65\text{ °C}$, full function | | 18 | V |
| | maximal 100 ms, $T_a = 65\text{ °C}$, full function | | 22 | V |
| | maximal 100 ms, full function, except H-Meter, some LED out of ordered | 4,5 | | V |
| ambient temperature for operation | | 0 | +85 | °C |
| capacity of the outputs | without time limit | | 0,25 | A |
| | without time limit (1 output only) | | 0,4 | A |
| External voltage on the outputs | Outputs with freewheeling diode for short out negative external voltage | -0,3 | U_b | V |
| External Voltage on the inputs | without time limit. Voltage which are out of the rating will be short out by the Z- diode. | -0,3 | U_b | V |
| Internal F1 | Micro fuse 5 x 20 mm glass fuse slow to blow | | 0,5 | A |

