



Fischer Panda

Manual

Description of the generator and operation manual



Marine Generator Panda PMS-HD 12-4KU Super silent technology

230V/400V - 50Hz / 10,5kW

120V/240V - 60Hz / 10,5kW

Fischer Panda GmbH

Current revision status

	Dokument
Actual:	Panda_12-4KU_HD-PMS_eng.R02_8.7.08
Replace:	Panda PMS-HD_12-4KU_Handbuch

Revision	Page
Part 1 + Part 2 joined	

Copyright

Duplication and change of the manual is permitted only in consultation with the manufacturer!

Fischer Panda GmbH, 33104 Paderborn, reserves all rights regarding text and graphics. Details are given to the best of our knowledge. No liability is accepted for correctness. Technical modifications for improving the product without previous notice may be undertaken without notice. Before installation, it must be ensured that the pictures, diagrams and related material are applicable to the genset supplied. Enquiries must be made in case of doubt.

Table of contents

Current revision status	2
5 Safety steps to follow if someone is the victim of electrical shock	7
WHEN AN ADULT STOPS BREATHING.....	8
Safety first.....	10
Tools.....	11
Safety Precautions	13
A The Panda Generator.....	15
A.1 Type plate at the Generator	15
A.2.1 Right Side View	16
A.2 Description of the Generator	16
A.2.2 Left Side View	17
A.2.3 Front View	18
A.2.4 Back View	19
A.2.5 View from above	20
A.3 Details of functional units	21
A.3.1 Remote control panel - see remote control panel datasheet	21
A.3.2 Components of Cooling System (Raw water)	21
A.3.3 Raw water intake	21
A.3.4 Components of Cooling System (Freshwater)	23
A.3.5 Components of the fuel system	26
A.3.6 Components of combustion air	29
A.3.7 Components of the electrical system	31
A.3.8 Sensors and switches for operating surveillance	35
A.3.9 Components of the oil circuit	37
A.3.10 External components	39
A.4 Operation manual	40
A.4.1 Preliminary remark	40
A.4.2 Daily routine checks before starting	40
A.4.3 Starting Generator - see remote control panel datasheet	42
A.4.4 Stopping the Generator- see remote control panel datasheet	42
A.4.5 Starting the Generator by a „Failure bypass switch“	42
B Generator Failure	43
B.1 Tools and Measuring Instruments	43
B.2 Overloading the Generator	43
B.2.1 Monitoring the Generator Voltage	44
B.2.2 Automatic Voltage Monitoring and Auto-Shut Down	45
B.3 Setting the Speed Governor of the Actuator	45
B.3.1 Setting the maximum upper speed setting	46
B.3.3 Greasing the trapezoidal thread spindle on the speed actuator	48
B.3.4 Consequences of a continual overloading of the Actuator	49
B.4 Generator-Output Voltage is too low	51
B.4.1 Discharging the Capacitors	51
B.4.2 Checking the Capacitors	52
B.4.3 Check the Generator Voltage	53
B.4.4 Measuring the Ohm Resistance of the Generator Windings	53
B.4.5 Check the Windings for Short Circuiting	54

Table of contents

B.4.6	Measuring the Inductive Resistance	54
B.5	Generator provides no voltage	55
B.5.1	Rotor Magnetism Loss and "Re-magnetising"	55
B.6	Engine Starting Problems	55
B.6.1	Fuel Solenoid Valve	55
B.6.2	Re-start with Failure Bypass Switch	56
B.6.3	Troubleshooting Table	57
C	Maintenance Instructions	59
C.1	General maintenance instructions	59
C.1.1	Checks before starting	59
C.1.2	Check of Hoses and Rubber Parts in the sound insulated capsule	59
C.2	Oil Change Intervals	59
C.3	Execution of an oil change	60
C.3.1	Check Oil Level of the Oil-Cooled Bearing	62
C.4	Checking the water separator in the fuel supply	62
C.4.1	Ventilating the Fuel System	63
C.4.2	Exchange of the Fuel Filter	64
C.4.3	Exchange the Air Filter Mat	65
C.4.4	Ventilation of the Coolant Circuit / Freshwater	66
C.4.5	Exchange of the V-Belt for the Internal Cooling Water Pump	68
C.5	The Seawater Circuit	70
C.5.1	Clean Seawater Filter	70
C.6	Reason for Frequent Impeller Wear	70
C.6.1	Exchanging the Impeller	71
C.7	Coolant Connection Block at the Generator Capsule	73
C.8	Conservation of the Generator (long operation interruption)	74
C.8.1	Measures for preparation of winter storage	74
C.8.2	Initiation during Spring	75
D	Installation Instructions	77
D.1	Placement	77
D.1.1	Advice for optimal sound insulation	77
D.2	Generator Connections	78
D.3	Cooling System Installation - Raw Water	79
D.3.1	General Information	79
D.3.2	Installation of the thru hull fitting in Yachts	79
D.3.3	Quality of the Raw Water Sucking In Line	80
D.3.4	Generator Installation above Waterline	80
D.3.5	Generator Installation below Water-Line	81
D.3.6	Generator Housing cooled by Raw Water	83
D.3.7	Indirect Cooling of the Genset Housing (by the Heat Exchanger)	83
D.4	The Freshwater Coolant Circuit	84
D.4.1	Position of the external cooling water expansion tank	84
D.4.2	Ventilating at the first filling of the Internal Cooling Water Circuit	85
D.4.3	Pressure Test for Controlling the Cooling Water Circuit	86
D.4.4	Scheme for Freshwater Circuit at Two Circuit Cooling System	87
D.4.5	Pressure Test for Controlling the Cooling Water Circuit	87
D.4.6	Scheme for Freshwater Circuit at Two Circuit Cooling System	88
D.5	Water Cooled Exhaust System	89
D.5.1	Installation of the Standard Exhaust System	89

Table of contents

D.5.2	Exhaust / Water separator	90
D.5.3	Installation Exhaust-Water-Separator	91
D.6	Installation of the Fuel System	92
D.6.1	General References	92
D.6.2	The Electrical Fuel Pump	93
D.6.3	Connection of the Fuel Lines at the Tank	94
D.6.4	Position of the Pre-Filter with Water Separator	94
D.6.5	Ventilating Air from the Fuel System	95
D.7	Generator 12 V DC System Installation	96
D.7.1	Connection of the 12 V Starter Battery	96
D.7.2	Connection of the remote control panel - see separate control panel manual	97
D.8.1	Installation with looped in AC-Control box	98
D.8.2	Installation AC-Box / distribution panel separate connected	99
D.8.3	AC Control Box with VCS and ASB	101
D.8.4	VCS Voltage Control	102
D.8.5	Jump Start at High Starting Current (Booster)	103
D.9	Insulation Test	103
E	Tables.....	105
E.1	Troubleshooting	105
E.2	Types of coil	115
E.3	Inspection checklist for services	117
E.4	Engine oil	118
E.5	Coolant	119
F	Generator Data.....	121
F.1	Generator Data	121
F.2	Capsule measurements	122
	Generator Control Panel P6+ Manual.....	123
	Current revision status	124
A	General operation	125
A.1	Panel Generator Control	125
A.2	Rear view 12V-version	126
A.3	Rear view 24V-version	127
A.3.1	Terminal connections	128
A.3.2	Function of the jumpers	129
A.3.3	Configuration and adjustment	130
A.4	Starting preparation / Checks (daily)	135
A.4.1	Marine version	135
A.4.2	Vehicle version	136
A.5	Starting and stopping the generators	136
A.5.1	Starting the generator	136
A.5.2	Stopping the generator	137
A.6	Automatic adapter - option	138
A.6.1	Terminal connections	140
A.7	Master-Slave adapter - option	141

Table of contents

A.7.1	Terminal connections	142
A.7.2	Configuration and adjustment	143
B	Measurements	147
B.1	Hole pattern	147



5 Safety steps to follow if someone is the victim of electrical shock

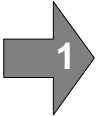

Do not try to pull or grab the individual.

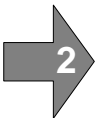

Send for help as soon as possible.

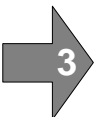

If possible, turn off the electrical power.

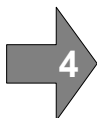

If you cannot turn off the electrical power, pull, push, or lift the person to safety using a wooden pole, rope, or some nonconductive material.



After the injured person is free of contact with the source of electrical shock, move them a short distance away and immediately start necessary first aid procedures.





WHEN AN ADULT STOPS BREATHING

WARNING



DO NOT attempt to perform the rescue breathing techniques provided on this page, unless certified. Performance of these techniques by uncertified personnel could result in further injury or death to the victim.

<p>1 Does the Person Respond?</p>		<p>2 Shout, "Help!"</p>
<p>Tap or gently shake victim. Shout, "Are you OK?"</p>		<p>Call people who can phone for help.</p>
<p>3 Roll Person onto Back.</p>		
<p>Roll victim toward you by pulling slowly.</p>		
<p>4 Open Airway.</p>		<p>5 Check for Breathing.</p>
<p>Tilt head back, and lift chin. Shout, "Are you OK?"</p>		<p>Look, listen, and feel for breathing for 3 to 5 seconds.</p>
<p>6 Give 2 Full Breaths.</p>		
<p>Keep head tilted back. Pinch nose shut. Seal your lips tight around victim's mouth. Give 2 full breaths for 1 to 1½ seconds each.</p>		
<p>7 Check for Pulse at side of Neck.</p>		<p>8 Phone EMS for Help.</p>
<p>Feel for pulse for 5 to 10 seconds.</p>		<p>Send someone to call an ambulance.</p>
<p>9 Begin Rescue Breathing.</p>		<p>10 Recheck Pulse Every Minute.</p>
<p>Keep head tilted back. Lift chin. Pinch nose shut. Give 1 full breath every 5 seconds. Look, listen, and feel for breathing between breaths.</p>		<p>Keep head tilted back. Feel for pulse for 5 to 10 seconds. If victim has pulse, not breathing, continue rescue breathing. If no pulse, begin CPR.</p>

				
Icemaster GmbH	Fischer Marine Generators	Conclusion Fischer - Icemaster GmbH	100 % water cooled Panda generators	Panda Vehicle Generators

Fischer Panda

FISCHER GENERATORS have been manufactured since 1978 and are a well-known brand for first class diesel generators with especially effective sound-insulation.

Fischer has been one of the leading manufacturers in respect of quality and know-how during this period.

FISCHER, as the worldwide manufacturer of modern marine diesel generators, developed the Sailor-Silent series for example and produced a GFK sound-insulated capsule as early as 1979 and the basis for new generator technology.

The companies Fischer and Icemaster amalgamated under the direction of Icemaster in 1988, in order to concentrate on the development of new products. Production was moved to Paderborn.

The amalgamation of the two qualified companies led to the development of a complete new programme within a short space of time. The generators developed at that time set new technological standards worldwide.

The generators became more efficient and powerful than other generators in the same nominal performance range, because of the improved cooling. Panda generator demonstrated its superiority in several tests by renowned institutes and magazines during the past years. The patented VCS (voltage Control System) means it can meet all demands including motor speed. The start-booster (ASB) means Panda generators meet the highest demands in respect of voltage stability and starting values. A Panda generator, with the same drive motor, produces 15 % more effective output than the majority of conventional generators. This superiority in efficiency also ensures a fuel saving to the same extent.

The 100% water-cooled Panda generators are currently manufactured in the performance range from 2 to 100 kW in various versions. Fast running motors are preferred for performances up to approx. 30 kW (nominal speed 3000 rpm). The heavier slow runners are preferred for the higher range. The fast running generators have proved themselves many times for many uses, that they meet the demands in quality of yachts and vehicles, and offer space and weight saving of 50 % compared to slow running generators.

In addition to the Panda series, Fischer Panda also supply the super compact high-tech sound-insulated battery charging generators from the DC/AC Panda AGT series, which is a very interesting solution for the production of mobile power.

The HTG-alternators ensure that a charging rate of 285 amps is achieved that was scarcely thought possible for this compact construction. This alternator replaces a separate shipboard generators (constant 230 volts AC with up to 3500 kW from the main machine)

Fischer Panda GmbH, 33104 Paderborn, reserves all rights regarding text and graphics. Details are given to the best of our knowledge. No liability is accepted for correctness. Technical modifications for improving the product without previous notice may be undertaken without notice. Before installation, it must be ensured that the pictures, diagrams and related material are applicable to the genset supplied. Enquiries must be made in case o doubt.

Safety first

These symbols are used throughout this manual and on labels on the machine itself to warn of the possibility of personal injury. Read these instructions carefully. It is essential that you read the instructions and safety regulations before you attempt to assemble or use unit.



This danger symbol refers to toxic danger and draws attention to special warnings, instructions or procedures which, if not strictly observed, may result in severe personal injury or loss of life.



This danger symbol refers to electric danger and draws attention to special warnings, instructions or procedures which, if not strictly observed, may result in electrical shock which will result in severe personal injury or loss of life.









This warning symbol draws attention to special warnings, instructions or procedures which, if not strictly observed, may result in damage or destruction of equipment, severe personal injury or loss of life.



This warning symbol draws attention to special warnings, instructions or procedures which, if not strictly observed, may result in damage or destruction of equipment

Tools

This symbols are used throughout this manual to show which tool must be used at maintenance or installation.

	<p>Spanners X = required size</p>
	<p>Hook wrench for oil filter</p>
	<p>Screw driver, for slotted head screws and for recessed head screws</p>
	<p>Multimeter, multimeter with capacitor measuring</p>
	<p>Socket wrench set</p>
	<p>Hexagon wrench keys</p>

CALIFORNIA

Proposition 65 Warning

Diesel engine exhaust and some of its constituents are known to the State of California to cause cancer, birth defects, and other reproductive harm.



Attention, Important Directions regarding Operation!

1. The installation certificate must be completed when taken into use, and certified by a signature.
2. The installation certificate must be despatched within two weeks of use to Fischer Panda.
3. The official guaranty confirmation will be completed by Fischer Panda after receipt and sent to the customer.
4. A guaranty must be shown to make any claims.

Claims against the guaranty will not be accepted if the above said instructions are not, or only partially, carried out.

Manufacturer declaration in accordance with the machine guideline 98/37/EG

The generator has been developed in such a way, that all assembly groups correspond to the CE guidelines. If machine guideline 98/37/EG is applied, then it is forbidden to start the generator, until it has been ascertained that the system into which the generator is to be integrated, also corresponds to the machine guideline regulation 98/37/EG. This includes the exhaust system, cooling system and electrical installation.

The evaluation of "protection against contact" must be carried out when installed, in conjunction with the respective system. This includes correct electrical connections, a safe ground wire connection, foreign body and humidity protection, protection against humidity due to excessive condensation, as well as overheating through appropriate and inappropriate use in its installed state. The responsibility lies with those who undertake installation of the generator in the final system.

Use the advantages of the customer registration:

- Thus you receive to extended product informations, which are sometimes safety-relevant
- you receive, if necessarily free Upgrades

Far advantages:

By your full information Fischer Panda technicians can give you fast assistance, since 90% of the disturbances result from errors in the periphery.

Problems due to errors in the installation can be recognized in the apron.

Technical Support per Internet: info@fischerpanda.de

Safety Precautions

The electrical installations may only be carried out by trained and qualified personnel!



Safety Instructions concerning operating the generator

- The generator must not be taken into use with the cover removed.
- If the generator is being installed without a sound insulation capsule, then make sure, that all rotating parts (belt-pulley, belts etc) are covered and protected so that there is no danger to life and body!
- If a sound insulation covering will be produced at the place of installation, then well-placed signs must show that the generator can only be switched on with a closed capsule.
- All servicing-, maintenance or repair work may only carried out, when the motor is not running.
- There is full current in the AC control box when the generator is running. It must therefore be ensured that the control box is closed and cannot be touched when the generator is running.
- Do not work in an ambient, where there are explosives. Working on an electrical system in an ambient where there are flammable gases is dangerous.
- Electrical voltages above 48 volts (battery chargers greater than 36 volts) are always dangerous to life). The rules of the respective regional authority must be adhered to. Only an electrician may carry out installation of the electrical connections for safety reasons.

Ground Wire:

The generator, is "earthed" as series (centre and ground are connected together in the generator terminal box by a bridge). This is an initial ground fuse, which offers protection, as long as no other measures are installed. Above all, it is conceived for the delivery and possible test run.

This "neutralisation" (Protective Earthing Neutral - PEN) is only effective, if all parts of the electrical system are commonly "earthed" to a common potential. The bridges can be removed, if this is necessary for technical reasons and another protective system has been setup.

Safety Instructions concerning working on the generator

The battery must always be disconnected, if work on the generator or electrical system is to be carried out, so that the generator cannot be unintentionally started. **It is not allowed to disconnect the battery during operation!** After the generator has been stopped, the battery can be disconnected!

Switch off all load when working on the generator

All load must be disconnected, in order to avoid damages to the devices. In addition the semi conductors in the AC control box must be disconnected in order to avoid the boat capacitors being activated. The minus pole of the battery ought to be removed.

Safety Instructions concerning the capacitors

Capacitors are required to run the generator. These have two varying functions:

- A) The working capacitors
- B) The (Booster) capacitors

Both Groups are located in a separate AC-Control box.

Capacitors are electrical stores. There could be a residual of high electrical current at the contacts for a period disconnection from the circuit. The contacts may not be touched for safety reasons, If the capacitors are to be exchanged or checked, and then a short circuit between the contacts should be made so that the stored energy is discharged.

If the generator is switched off in the normal manner, the working capacitors are automatically discharged by means of the windings. The booster capacitors are discharged by means of internal discharge resistors.

All capacitors must be short-circuited before work is carried out on the AC-Control box for safety reasons.

Safety Instructions concerning the cables

Cable Type

It is recommended is that the cable used be UL 1426 (BC-5W2) compliant, with Type 3 stranding (ABYC Section E-11)

Cable Size

The cable size must be selected taking into account the amperage, voltage and conductor length (from the positive power source connection to the electrical device and back to the negative power source connection).

Cable Installation

It is recommended that a self draining wire loom classified as V-2 or better in accordance with UL 94 be installed in the section of the cable routed in the interior of the sound capsule. Care should be taken to avoid hot surfaces such as the exhaust manifold or engine oil drain bolt and routed clear of any possible sources of chafing.

Battery

Warning:

Do not use Gel-Cel batteries, because the regulation voltage is high for this type of batteries.

Do not use large batterybanks as a starting battery. The generator must have a dedicated starter battery (maximum size group 24).



Recommend starter battery size (if model not shown - please see engine manual)

Panda 6000 -8000	12V, 28AH equivalent		Panda 18	12V, 65AH equivalent
Panda 9000-14000	12V, 36AH equivalent		Panda 24-30	12V, 70AH equivalent
Panda 16	12V, 52AH equivalent		Panda 33-42	12V, 100 to 120AH equivalent

A. The Panda Generator

A.1 Type plate at the Generator

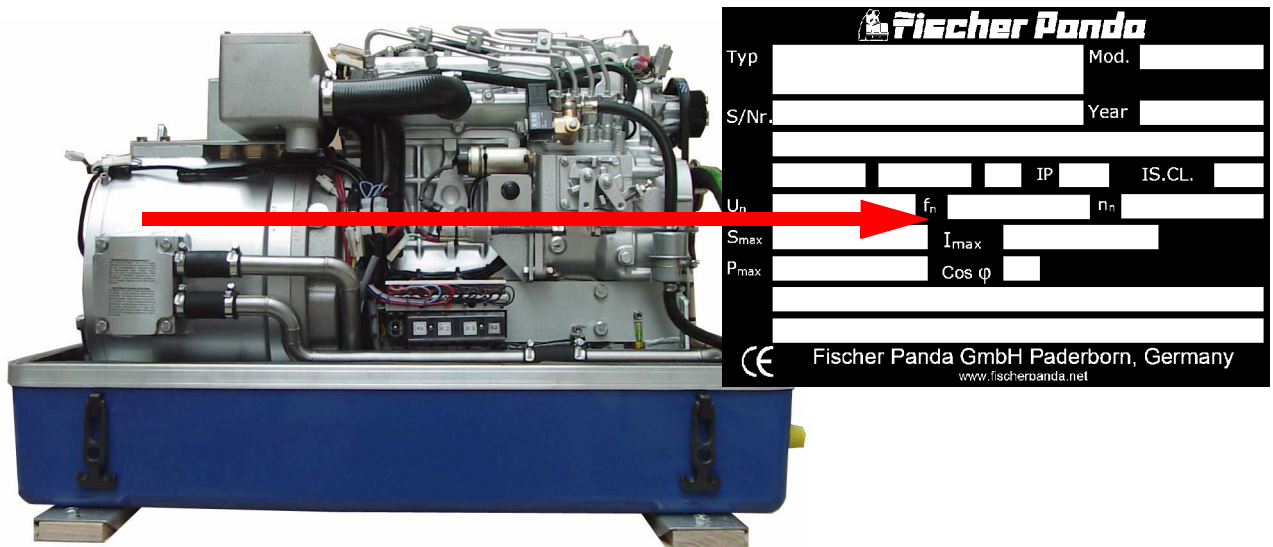

Fig. A.1-1: Type plate

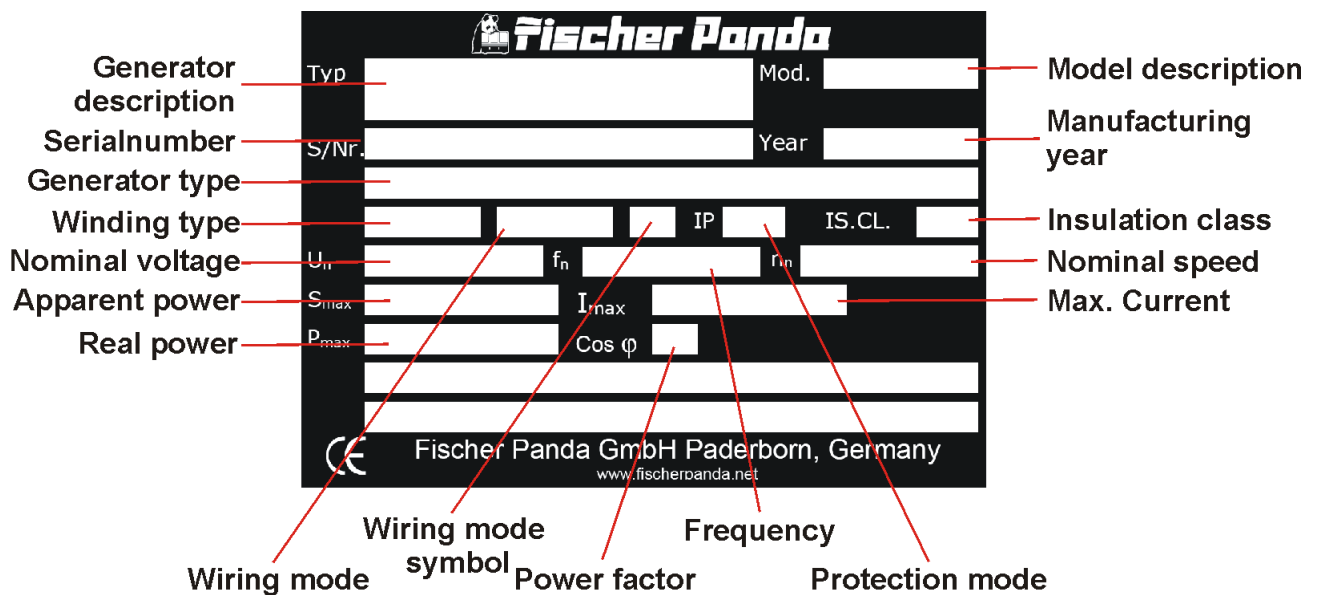
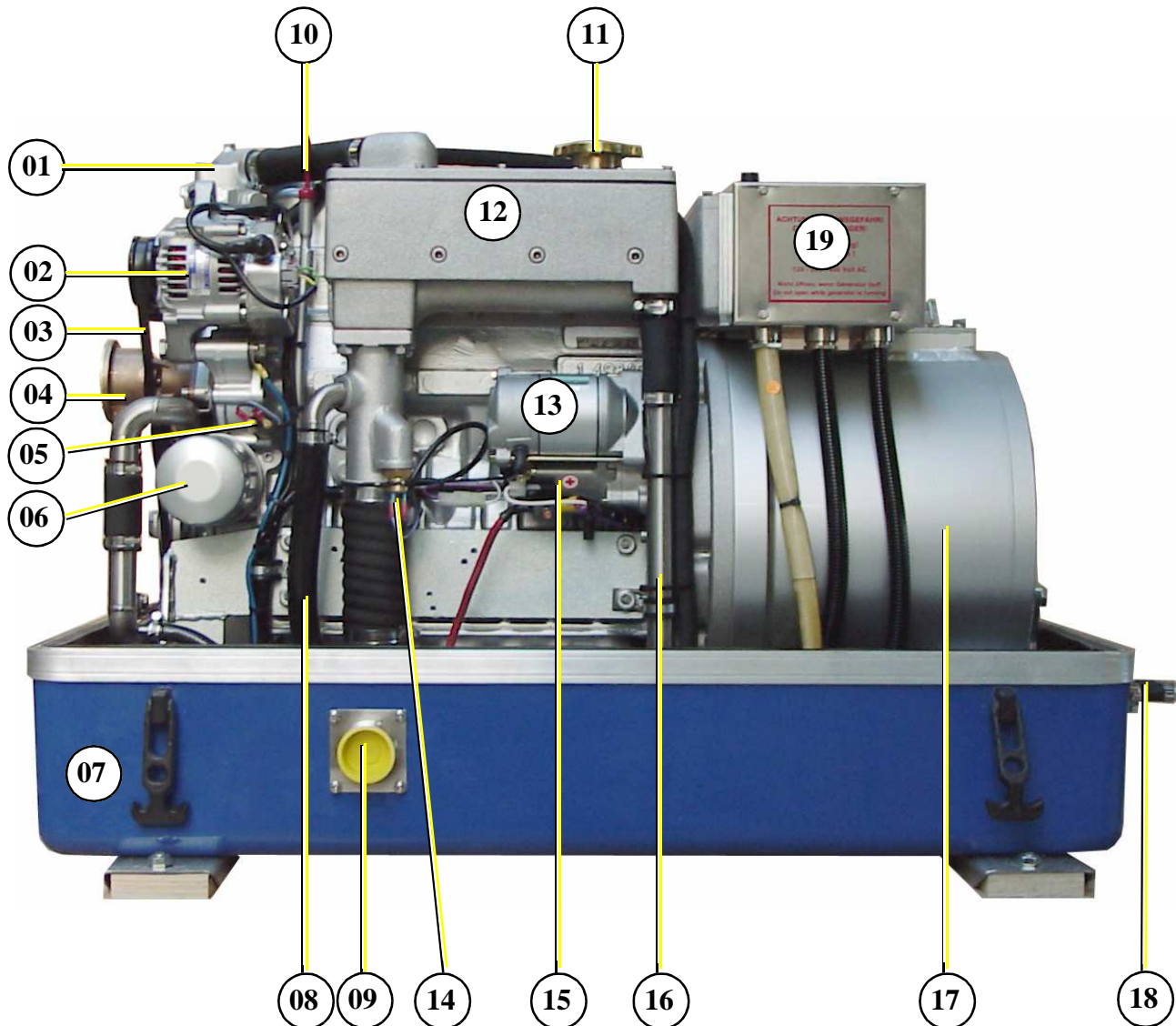

Fig. A.1-2: Discription type plate



A.2 Description of the Generator

A.2.1 Right Side View



- | | |
|---|---|
| 01. Thermostat housing | 11. Cooling water filler neck with cap |
| 02. 12V-DC-alternator | 12. Water-cooled exhaust elbow |
| 03. V-belt for DC-alternator and cooling water pump | 13. Starter motor |
| 04. Raw water pump | 14. Thermo-switch exhaust elbow |
| 05. Oil pressure switch | 15. Solenoid for starter motor |
| 06. Oil filter | 16. Cooling water backflow pipe |
| 07. Sound cover - base part | 17. Generator housing with coil |
| 08. Hose for raw water flow for injector nozzle | 18. Intake from the external cooling water expansion tank |
| 09. Exhaust outlet | 20. Power terminal box |
| 10. Oil dipstick | |

A.2.2 Left Side View

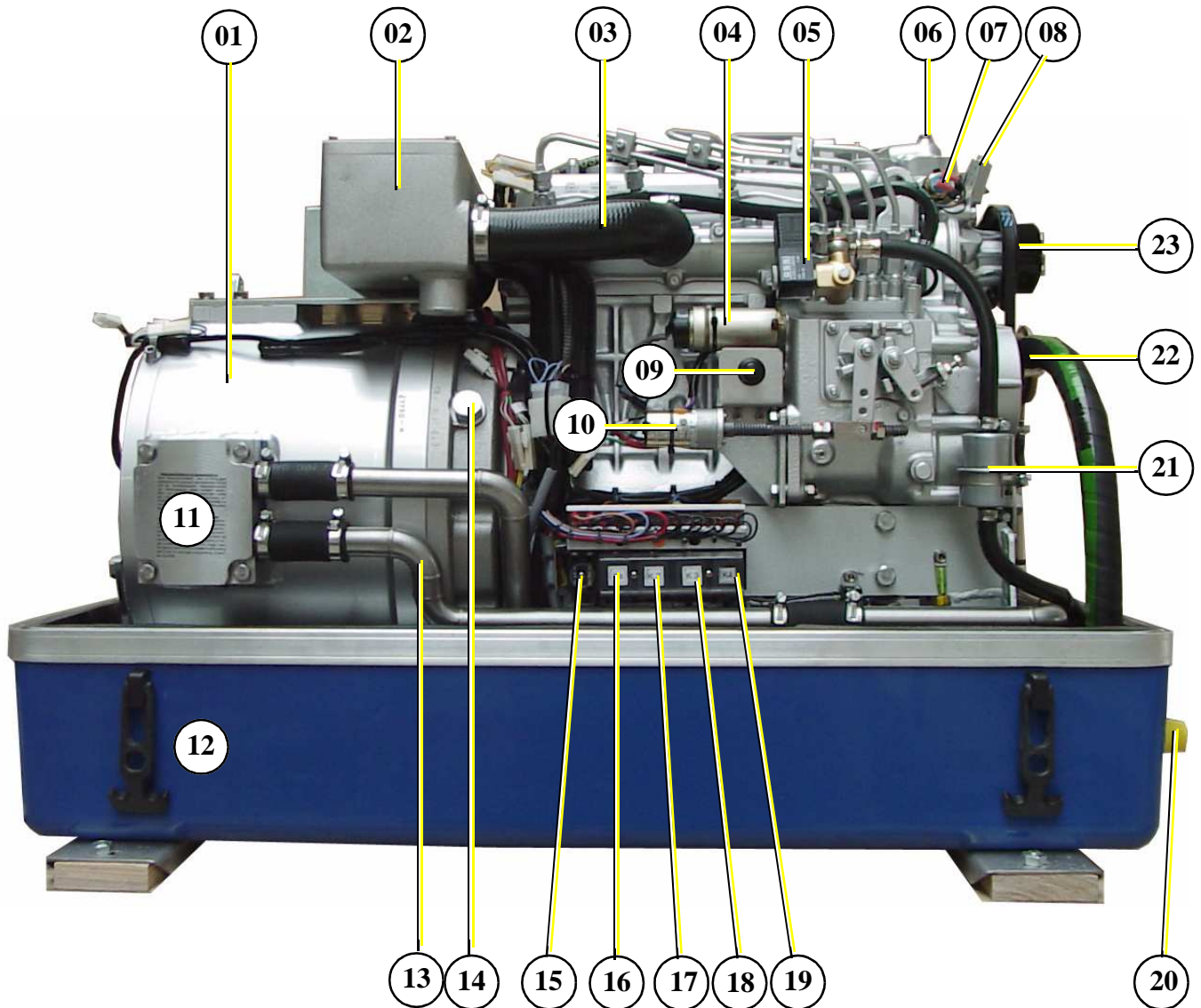

- | | |
|---|---|
| 01. Generator housing with coil | 13. Cooling water pipe, connection block - water pump |
| 02. Air suction housing with air filter | 14. Plug for speed sensor |
| 03. Suction hose, air suction housing - induction elbow | 15. Electrical fuses (blue=15A, white=25A) |
| 04. Stop solenoid for engine stop | 16. Relay Ks for starter motor |
| 05. Fuel solenoid valve | 17. Relay K2 for glow plugs |
| 06. Ventilation screw thermostat housing | 18. Relay K3 for fuel pump |
| 07. Thermo-switch at thermostat housing | 19. Relay K4 for stop solenoid |
| 08. Ventilation screw water pump | 20. Raw water intake |
| 09. Failure bypass switch | 21. Fuel filter |
| 10. Actuator | 22. Raw water pump |
| 11. Cooling water connection block | 23. Pulley for internal cooling water pump |
| 12. Sound cover base part | |

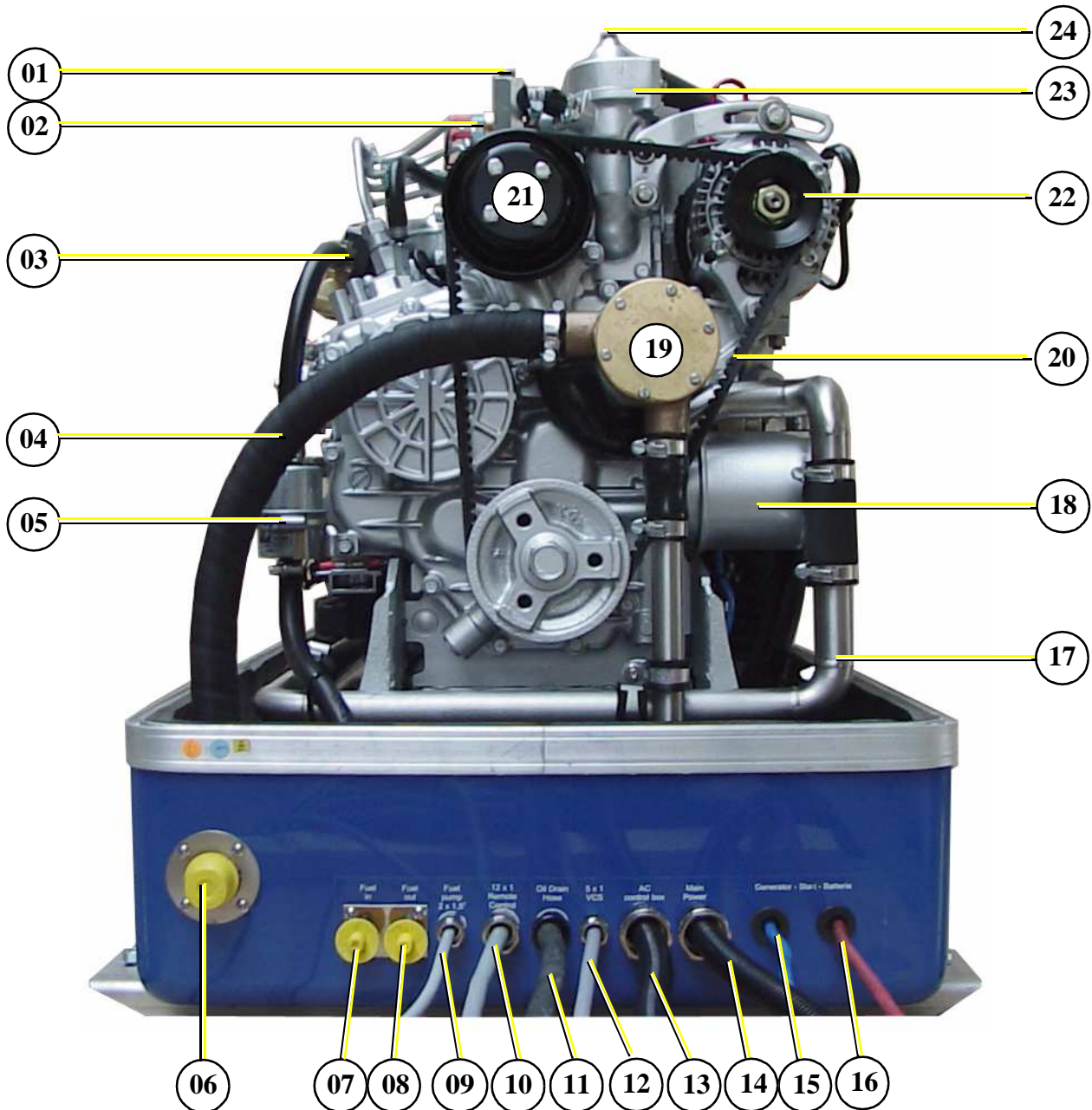
A.2.3 Front View

- | | |
|--|--|
| 01. Ventilation screw water pump | 13. Electrical cable for AC-Control box |
| 02. Thermo-switch at thermostat housing | 14. Electrical cable for load |
| 03. Fuel solenoid valve | 15. Starter battery minus (-) |
| 04. Hose for raw water intake | 16. Starter battery plus (+) |
| 05. Fuel filter | 17. Cooling water pipe, connection block - water pump |
| 06. Raw water intake | 18. Oil filter |
| 07. Fuel intake connection | 19. Raw water pump |
| 08. Fuel backflow connection | 20. V-belt for DC-alternator and internal cooling water pump |
| 09. Electrical cable fuel pump (2x1,5mm ²) | 21. Pulley for internal cooling water pump |
| 10. Electrical cable remote control panel | 22. 12V DC-alternator |
| 11. Oil drain hose | 23. Thermostat housing |
| 12. Electrical cable VCS | 24. Ventilation screw thermostat housing |

A.2.4 Back View

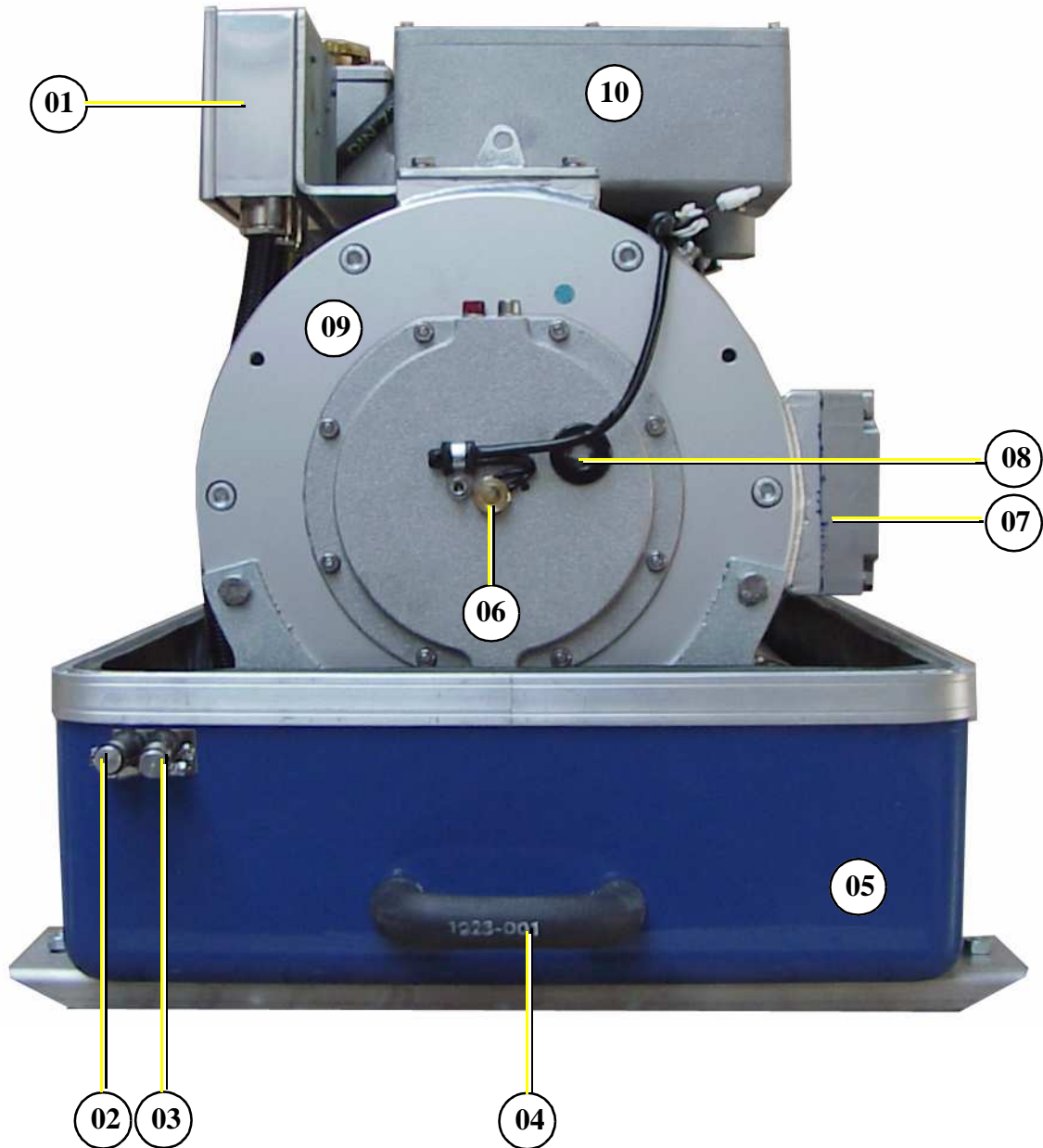

- 01. Power terminal box
- 02. Intake from the external cooling water expansion tank
- 03. Backflow to the external cooling water expansion tank
- 04. Connection external ventilation valve
- 05. Sound cover - base part

- 06. Thermo-switch at oil cooled bearing
- 07. Cooling water connection block
- 08. Oil flow glass
- 09. Generator front plate
- 10. Air suction housing with air filter

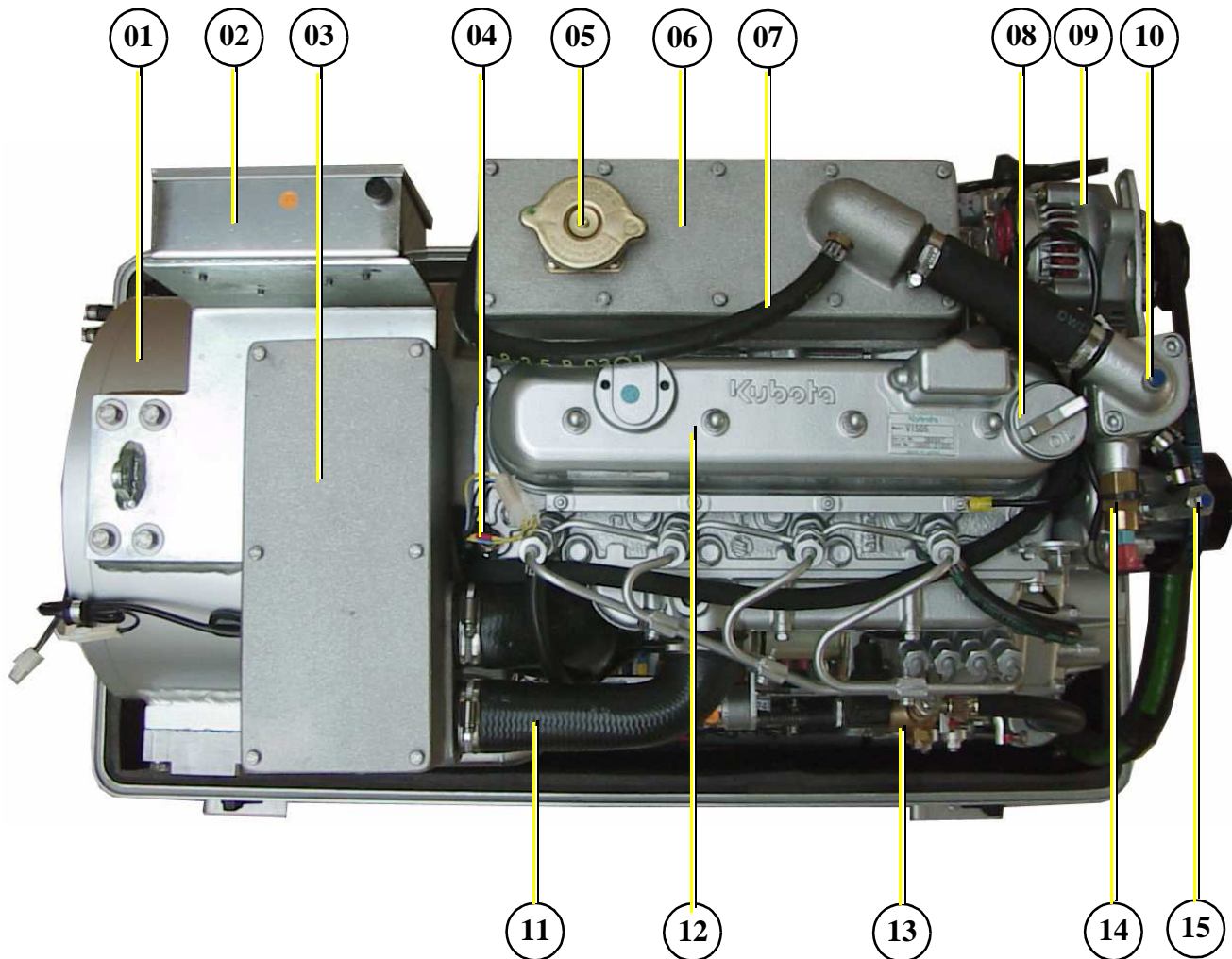
A.2.5 View from above

- | | |
|--|---|
| 01. Generator housing with coil | 09. 12V DC-alternator |
| 02. Power terminal box | 10. Ventilation screw thermostat housing |
| 03. Air suction housing with air filter | 11. Suction hose, air suction housing - induction elbow |
| 04. Thermo-switch at cylinder head | 12. Cylinder head |
| 05. Cooling water filler neck with cap | 13. Fuel solenoid valve |
| 06. Water-cooled exhaust elbow | 14. Thermo-switch at thermostat housing |
| 07. Hose for backflow to external cooling water expansion tank | 15. Ventilation screw water pump |
| 08. Oil filler neck | |



A.3 Details of functional units

A.3.1 Remote control panel - see remote control panel datasheet

The remote control panel is necessary to control the generator and to evaluate the motor/generator properties. The generators will automatically cutout if it does not run as required. The generator may not be run without the remote control panel.

A.3.2 Components of Cooling System (Raw water)

Raw water intake

The diagram shows the supply pipes for the generator. The connection neck for the raw water connection is shown on the left hand side. The cross-section of the intake pipe should be nominally larger than the generator connection.



A.3.3 Raw water intake

Raw water impeller pump

The raw water pump is fitted with a rubber impeller. This pump is self-inductive. If, for example, you forget to open the sea valve, then you must expect the impeller to be destroyed after a short period of time. It is recommended to store several impellers on board as spare parts.

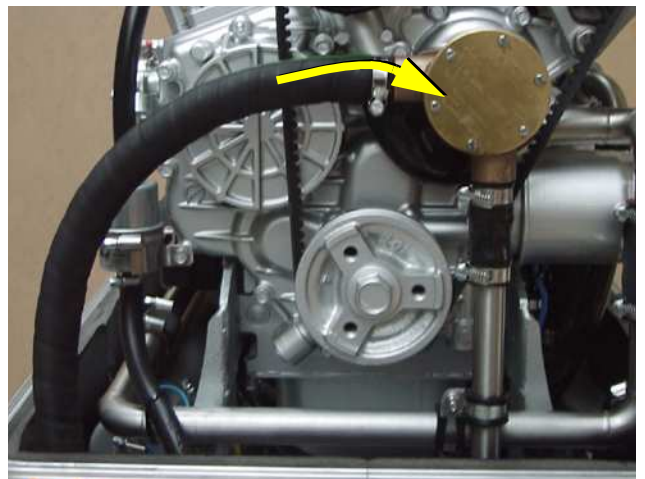

Fig. A.3.3-1: Raw water impeller pump

Heat exchanger

Separates the raw water system from the freshwater system.

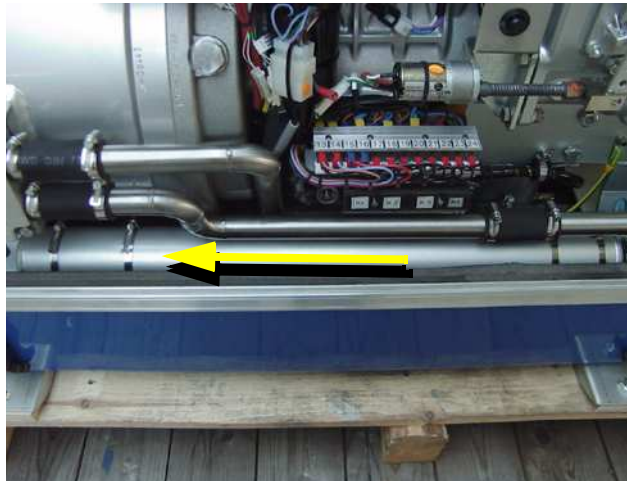

Fig. A.3.3-2: Heat exchanger

Ventilation valve

A siphon must be installed if the generator sinks below the water line because of the rocking of the boat, even if it is only for a short period of time. A hosepipe on the generator casing has been produced for this. Both connecting pieces are bridged by a formed piece of hose.

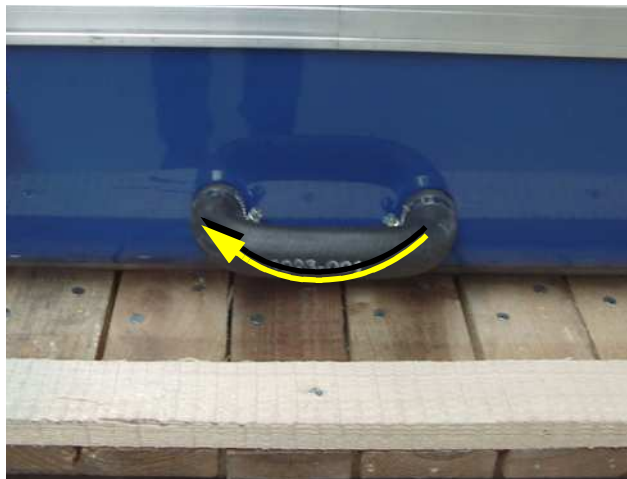

Fig. A.3.3-3: Connection external ventilation valve

Cooling water injector nozzle

The injection point for the marine generator water-cooled exhaust system is situated at the exhaust connection pieces. The exhaust connections must be regularly checked for signs of corrosion.

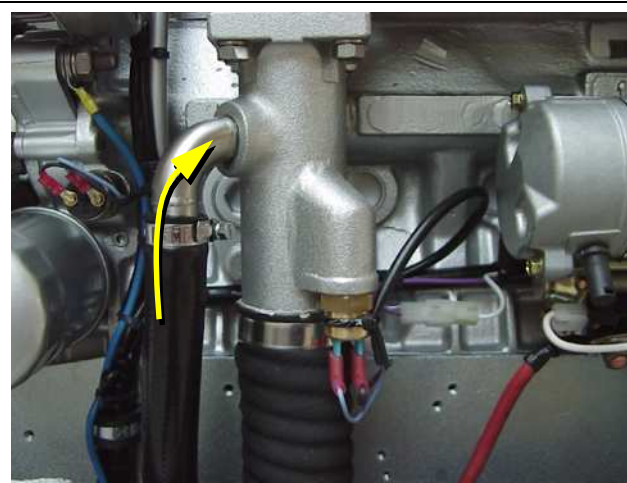

Fig. A.3.3-4: Cooling water injector nozzle

A.3.4 Components of Cooling System (Freshwater)

Cooling water filler neck

The cooling water filler neck situated at the water-cooled manifold are only used, when the generator is initially started. Since the generator is normally already filled with cooling water, these components are only by the user, if repairs are to be carried out. Topping up with cooling water may only carried out at the external cooling water compensation tank. Note that the water level in the cooling water compensation tank is only 20% of the volume in a cold state.

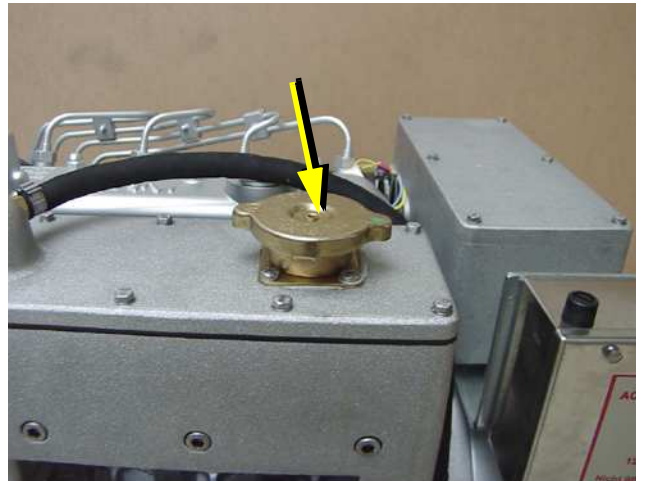

Fig. A.3.4-1: Cooling water filler neck

Ventilation pipe

The ventilation pipe at the water-cooled exhaust manifold leads to the external expansion tank. This pipe only serves as a ventilation pipe, if both pipes are to be connected to the external expansion tank (ventilation pipe and intake pipe).

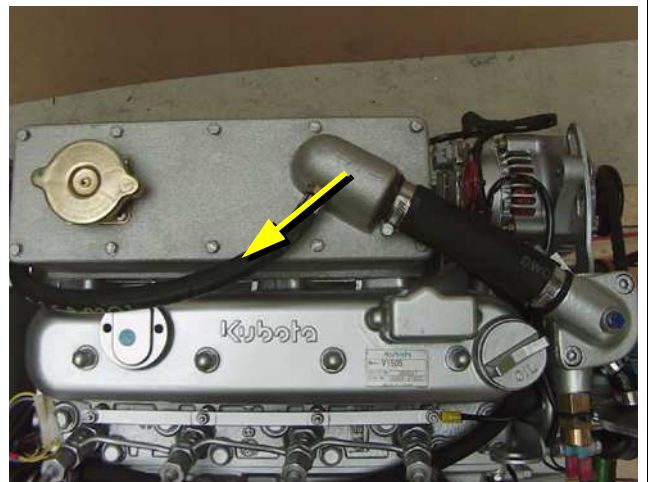

Fig. A.3.4-2: Ventilation pipe

Hose connection pieces for the external expansion tank

The external expansion tank is connected by two hose connections. The connecting pieces shown here serves as constant ventilation for the water-cooling system.

In case the external expansion tank is connected with two hoses, the system will ventilate itself. In this case, additional ventilation is only necessary when the generator is initially filled, or if the cooling water is not circulating.



Fig. A.3.4-3: External expansion tank

Freshwater backflow

The cooling water is fed to the heat exchanger from the water-cooled manifold by means of the pipe shown in the diagram.

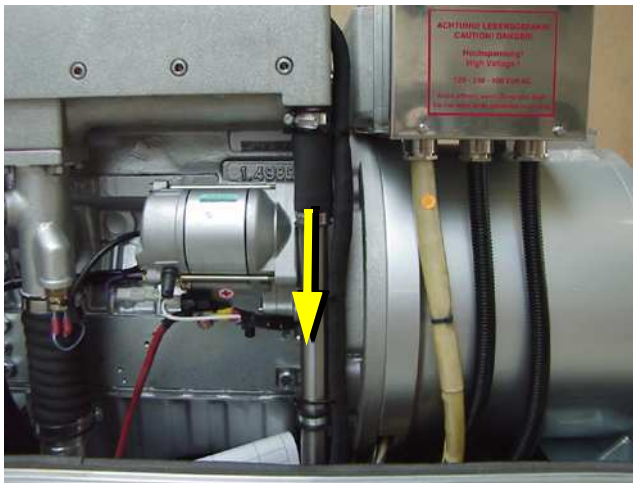

Fig. A.3.4-4: Freshwater backflow

Heat exchanger

Separates the raw water system from the freshwater system.

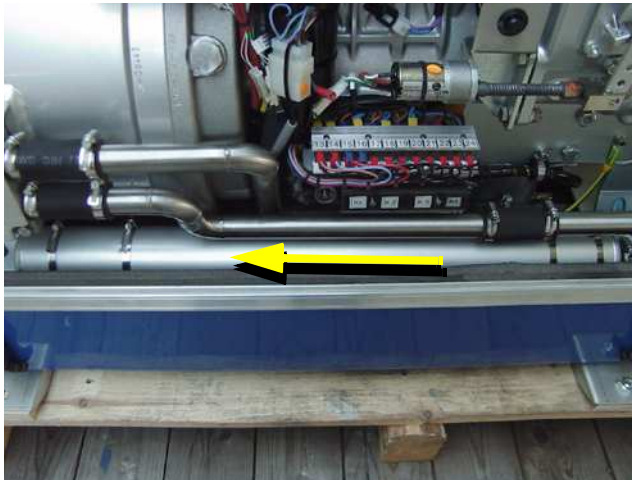

Fig. A.3.4-5: Heat exchanger

Cooling water connection block

The cooling water is fed to the generator and drained via the cooling water connection block. The cooling water connection block consists of an aluminium alloy, which can behave like a sacrificial anode.

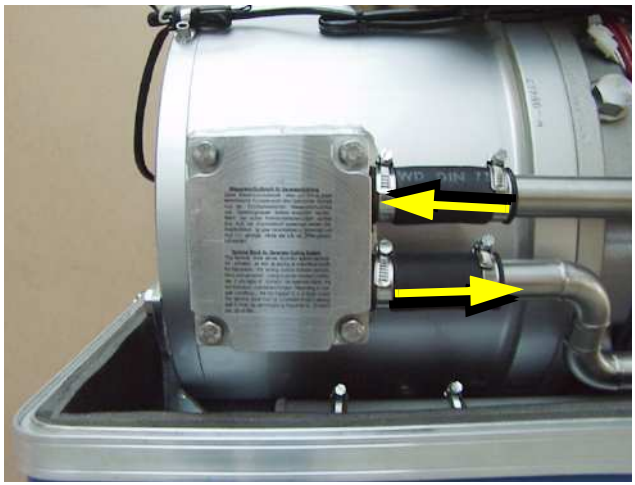

Fig. A.3.4-6: Cooling water connection block

Internal cooling water pump

The diesel motor cooling water pump (see arrow) aids the circulation of the internal freshwater system.

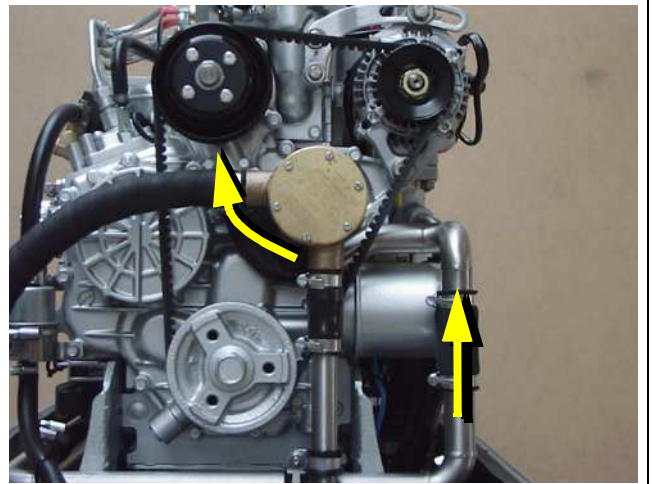

Fig. A.3.4-7: Internal cooling water pump

Cooling water intake

The intake pipe from the external cooling water expansion tank is connected here.

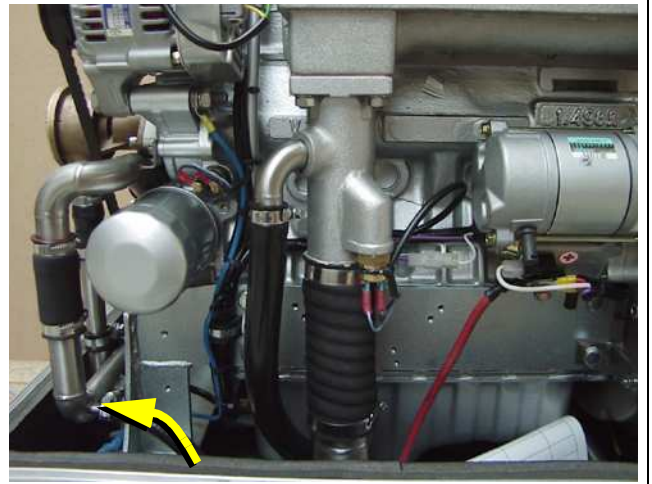

Fig. A.3.4-8: Internal cooling water pump

Ventilation screw cooling water pump

The ventilation screw above the cooling water pump casing may not be opened, whilst the generator is running. If this occurs by mistake, air will be drawn through the opening. Extensive ventilation of the whole system is then necessary.



Fig. A.3.4-9: Ventilation screw cooling water pump

Ventilation screw thermostat housing

The ventilation screw on the thermostat housing should occasionally be opened for control purposes. Standing machinery should principally carry out ventilating.



Fig. A.3.4-10: Ventilation screw thermostat housing

Water-cooled exhaust manifold

The manifold is cooled by means of the internal cooling system (freshwater). The cooling water filler necks on the casing of the manifold may not be opened. These cooling water necks are only required to fill the motor with cooling water in cases of repair. The normal cooling water controls may only be carried out at the external expansion tank.

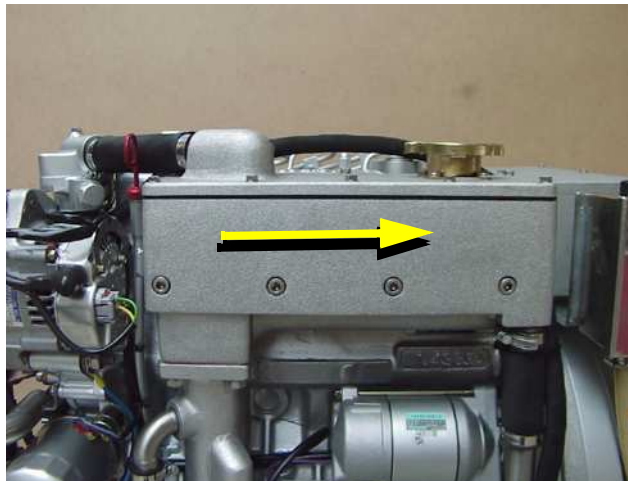

Fig. A.3.4-11: Water-cooled exhaust manifold

A.3.5 Components of the fuel system

External fuel pump

The Panda generator is always supplied with an external, electrical (12 V of DC) fuel pump. The fuel pump must be always installed in the proximity of the tank. The electrical connections with the lead planned for it are before-installed at the generator. Since the suction height and the supply pressure are limited, it can be sometimes possible that for reinforcement a second pump must be installed.

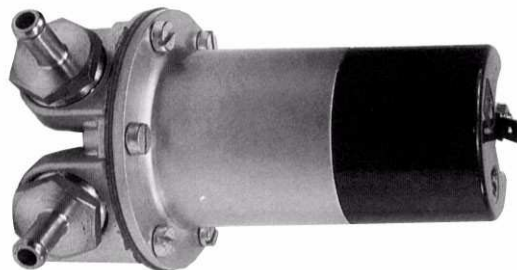

Fig. A.3.5-1: External fuel pump

Connecting pieces for the fuel pipe

1. Fuel intake
2. Fuel backflow

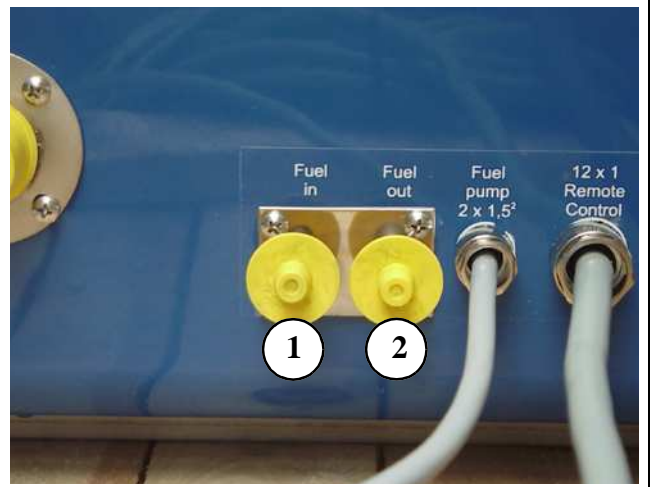

Fig. A.3.5-2: Fuel connections

Fuel Filter

A consequential filtering of fuel is especially important for all marine systems.

A fine filter, which is firmly attached to the inside of the sound insulation capsule for the marine version, is supplied on delivery, and loose for other makes. In all cases a further pre-filter with water separator must be installed. See directions for fuel filter installation.

Sample Picture

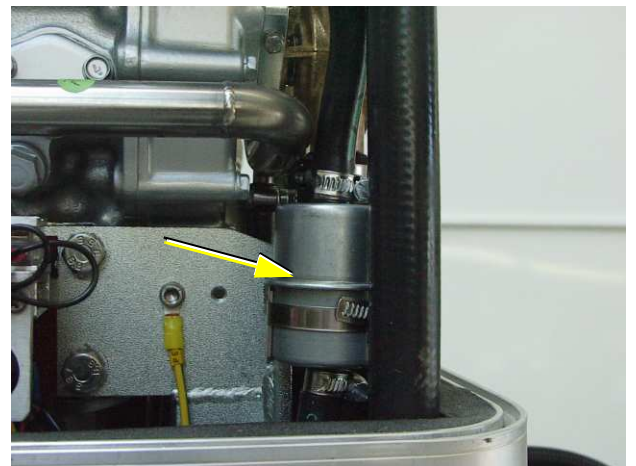

Fig. A.3.5-3: Fuel Filter

Fuel filter with water separator (optional)

A consequential filtering of fuel is especially important for all marine systems. See directions for fuel filter installation.

Sample Picture

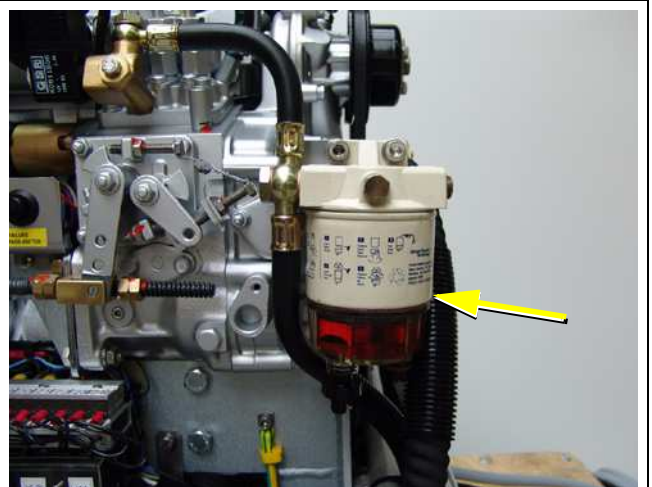

Fig. A.3.5-4: Fuel filter

Fuel solenoid valve

The fuel solenoid valve opens automatically if „START“ is pressed on the remote control panel“. The solenoid closes, if the generator is switched to „OFF“ position. It takes a few seconds before the generator stops. If the generator does not start or does not run smoothly (i.e. stutters), or does not attain full speed, then the cause is fore-mostly the solenoid.

- 1) Fuel solenoid valve
- 2) Ventilation screw solenoid valve
- 3) Magnetic coil

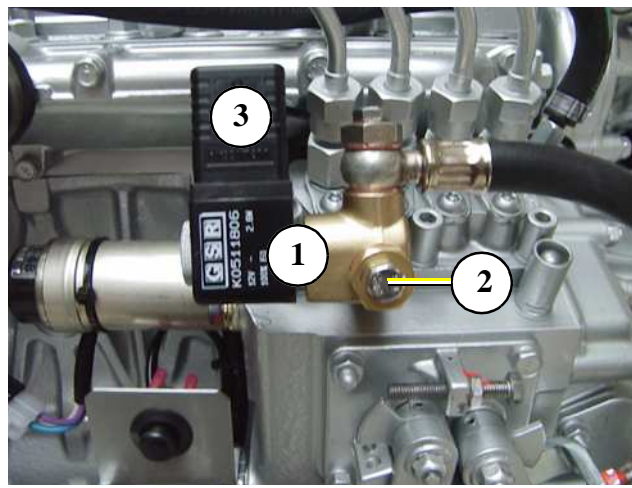

Fig. A.3.5-5: Fuel solenoid valve

Injection nozzles

If the engine does not start after the ventilation, the fuel injection lines must be de-aerated individually.

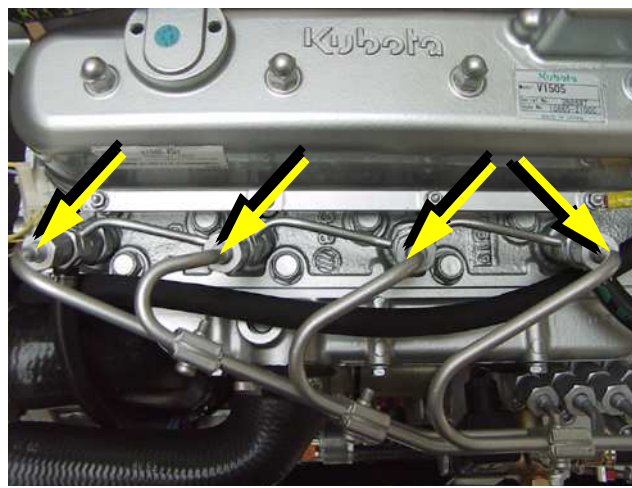

Fig. A.3.5-6: Injection nozzles

Glow plugs

The glow plugs serve the pre-chamber for the heating with cold start. The heat-treat fixture must be operated, if the temperature of the generator is under 16°C. This is practically with each start the case. The heat-treat fixture may be held down also during start and favoured the starting procedure.

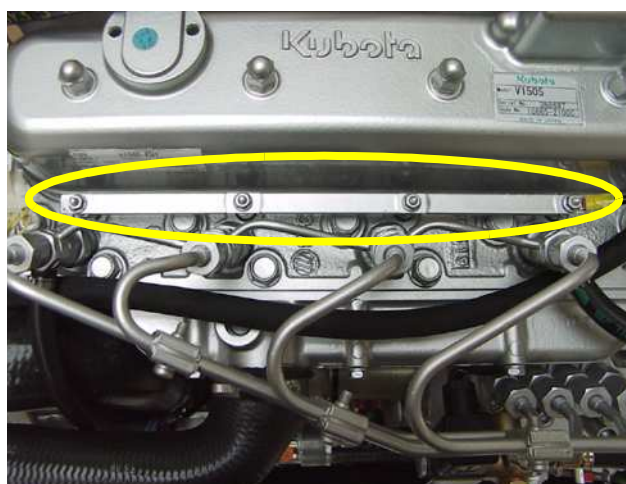

Fig. A.3.5-7: Glow plugs

Stop solenoid for engine stop

Some model are additional equipped with an stop solenoid. The generator is stopped by the co-operation of the stop solenoid immediately after switching off. The adjustment of the stop solenoid must always be checked, in order to be sure that the stop lever can move also during the operation freely and is not under pre-stressing.

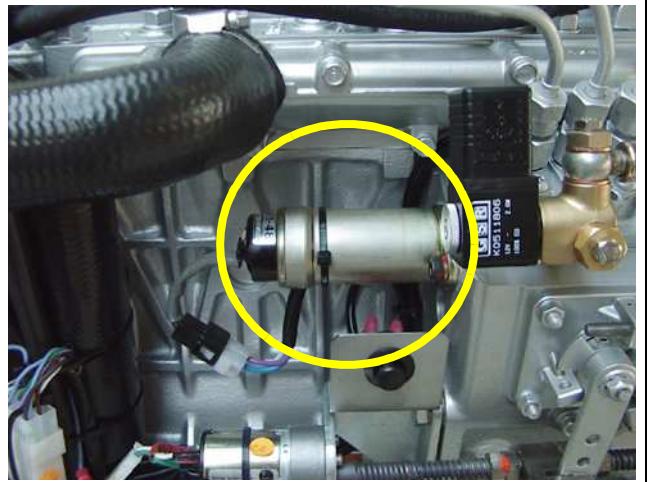

Fig. A.3.5-8: Stop solenoid

A.3.6 Components of combustion air

Air suction openings at the sound cover

The sound cover is provided at the back side with drillings, through which the combustion air can influx.

It must be consistently paid attention that the generator is installed in such a way that from down no water can arrive into the proximity of these air openings.



Fig. A.3.6-1: Combustion air intake

Air suction housing

If the cover is removed, the inside of the air suction housing becomes visible. In these air suction housings is a filter element. At the marine version the filter is normally not changed. It should be checked once in a while.

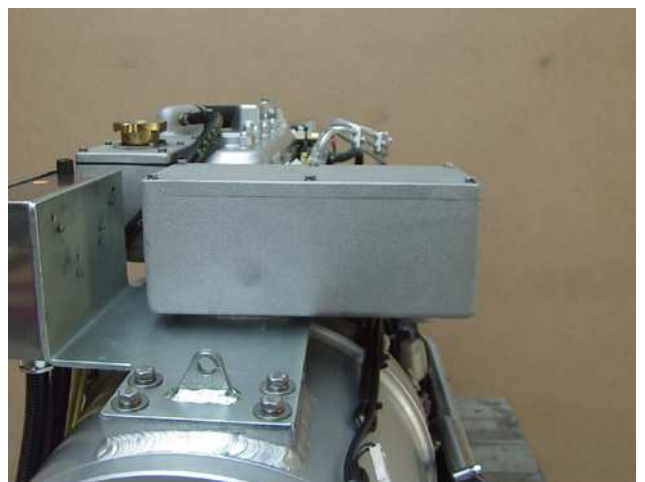

Fig. A.3.6-2: Air suction housing

Air suction housing with air filter set

The figure shows the air filter element in the air suction housing. However the return pipe of the crank case exhaust flows also into the air suction housing, it can be faced with older generators and/or with engines on high running time that oil vapors affect the air filter. Therefore an check is advisable once in a while.

Filter type: MANN FILTER C 34109

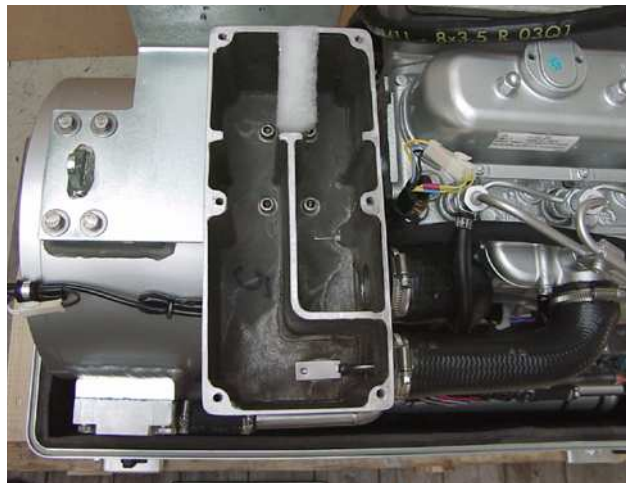

Fig. A.3.6-3: Air filter set

Combustion chamber intake elbow

The figure shows the induction elbow at the combustion engine. At the front of this induction elbow you can see the hose connection between air suction housings and induction elbow. The air filter must be checked, if this hose pulls together at operation.

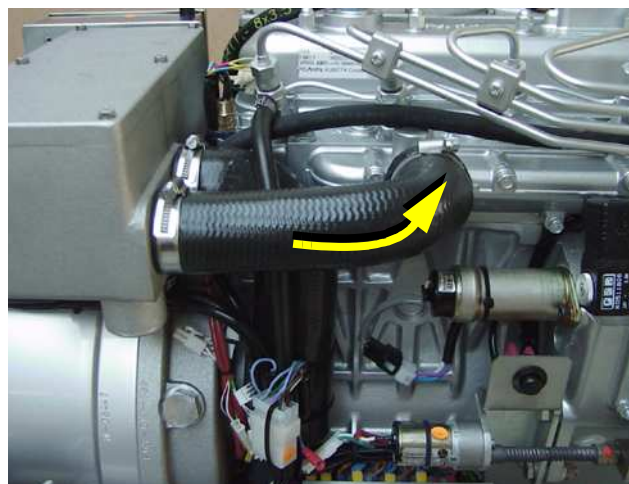

Fig. A.3.6-4: Combustion chamber intake elbow

Exhaust elbow

On the back of the engine is the water-cooled exhaust elbow. On the top side the pipe union for the internal raw water circuit is to be seen and the filler neck for the cooling water. This cooling water filler neck is used only at first filling. Control of the cooling water and if necessary refill takes place at the external cooling water expansion tank.



Fig. A.3.6-5: Exhaust elbow

Exhaust connection at the exhaust elbow

Raw water from the external cooling circle is fed here.

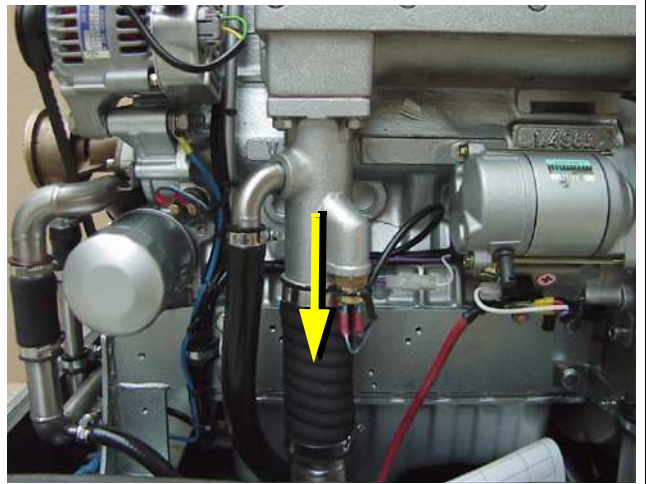

Fig. A.3.6-6: Exhaust connection

Exhaust outlet

Connect the exhaust pipe with the water lock.

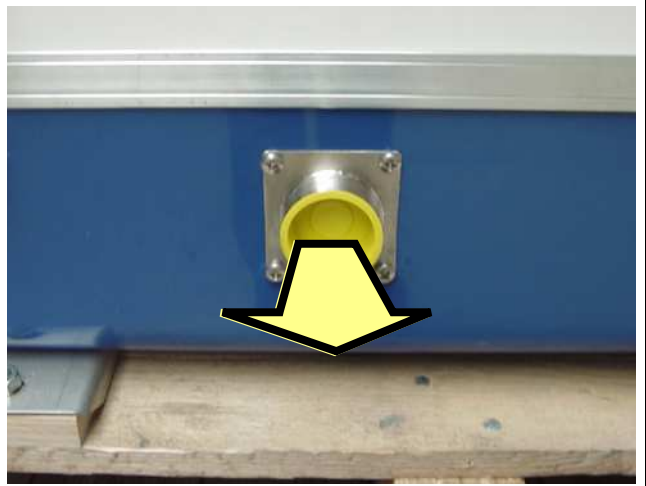

Fig. A.3.6-7: Exhaust outlet

A.3.7 Components of the electrical system

Connection starter battery

1. Cable for starter battery (minus)
2. Cable for starter battery (plus)

During the connection to the starter battery it must be always ensured that the contact is perfectly guaranteed.

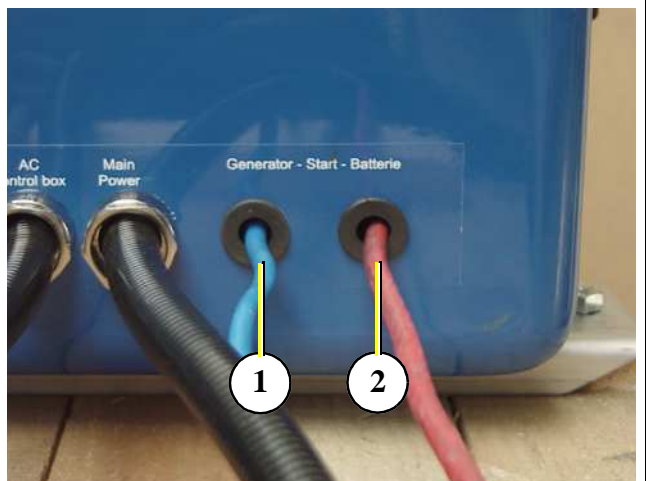

Fig. A.3.7-1: Cable for starter battery

Electrical connection for control

At the front of the generator also all remaining cables for the electrical connections are depending upon type. The allocation of the connections result from the plan for the AC-Control box. See here:

1. Fuel pump
2. Remote control panel
3. VCS
4. AC-Control box

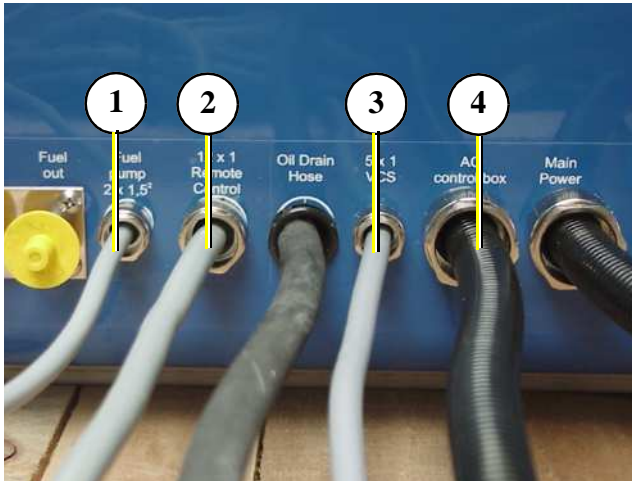

Fig. A.3.7-2:

Load

At the front of the sound cover is also the withdrawal for the cable for the main power. Depending upon type of the generator are here also the cables for the connection of the external condensers (see for this the connection diagram for the AC-Control box!)

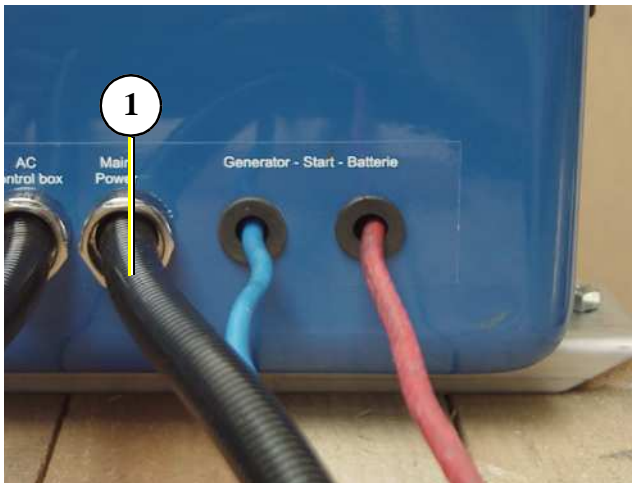

Fig. A.3.7-3: Load

Starter motor

1. Starter motor and
2. Solenoid switch

The Diesel engine is electrically started. On the back of the engine is accordingly the electrical starter with the solenoid switch.

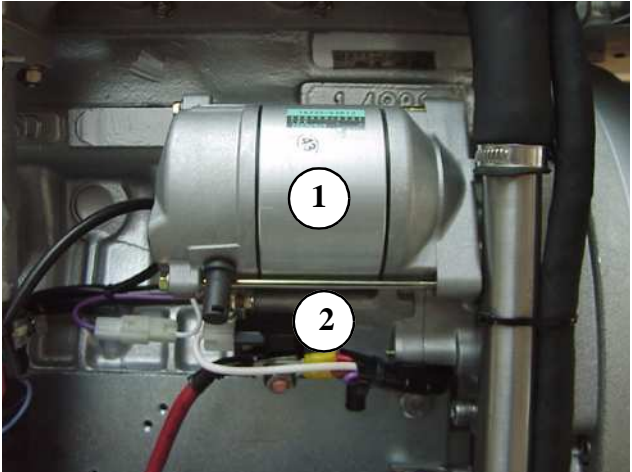

Fig. A.3.7-4: Starter motor

Actuator for speed regulation

The generator voltage is determined by progressive speed control through "VCS" in conjunction with the speed actuator. Speed increases with increasing load.

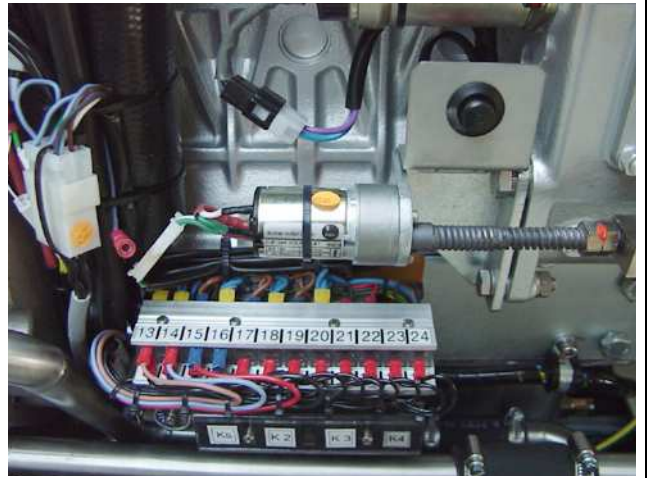

Fig. A.3.7-5: Actuator

Blind plug for speed sensor

All Panda generators can be equipped with an external automatic start. For the operation of this automatic starting system a separate speed sensor is necessary. At some models the speed sensor is standard installed. At other models the opening for the speed sensor is locked by a plug.

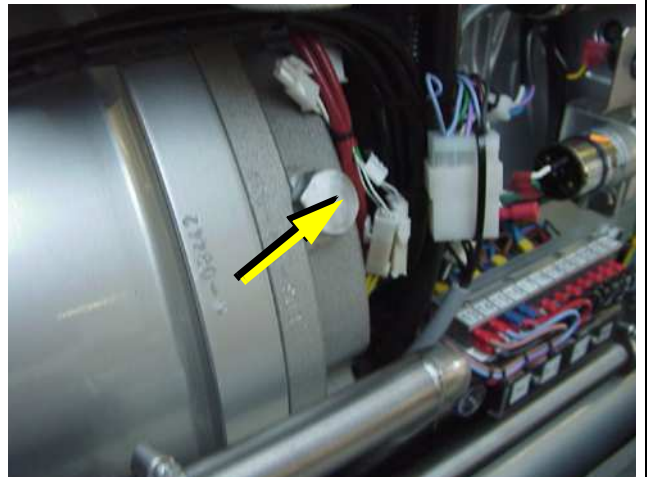

Fig. A.3.7-6: Blind plug

DC-alternator

All Panda generators from Panda 6.000 are provided with its own charge system for the 12V DC mains. This DC-alternator is powered over a v-belt together with the internal cooling water pump.

The 12V charge system may be used only for the generator-own starter battery.



Fig. A.3.7-7: DC-alternator

Generator Power Terminal Box 230V/50Hz

To locate the Terminalbox see Chapter A2.

In these terminal boxe there are the electrical connection points for the AC generator. Here is also the bridge for the protective grounding of the generator. The cover may only be removed, if it is guaranteed that the generator cannot be inadvertently started.

Sample Picture

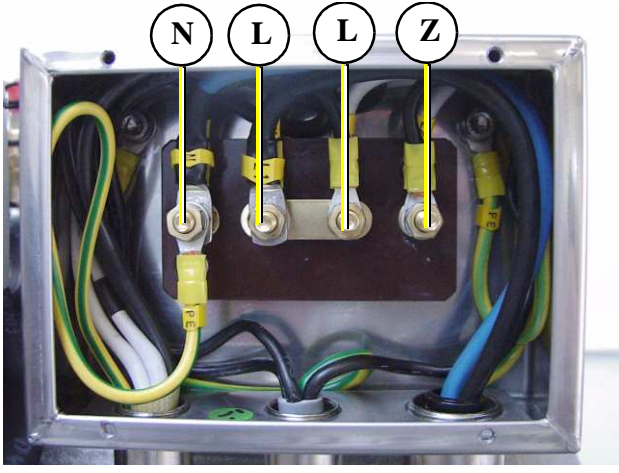

Fig. A.3.7-8: Generator Power Terminal Box 230V/50Hz

Generator Power Terminal Box 400V/50Hz

To locate the Terminalbox see Chapter A2.

In these terminal boxe there are the electrical connection points for the AC generator. Here is also the bridge for the protective grounding of the generator. The cover may only be removed, if it is guaranteed that the generator cannot be inadvertently started.

Sample Picture

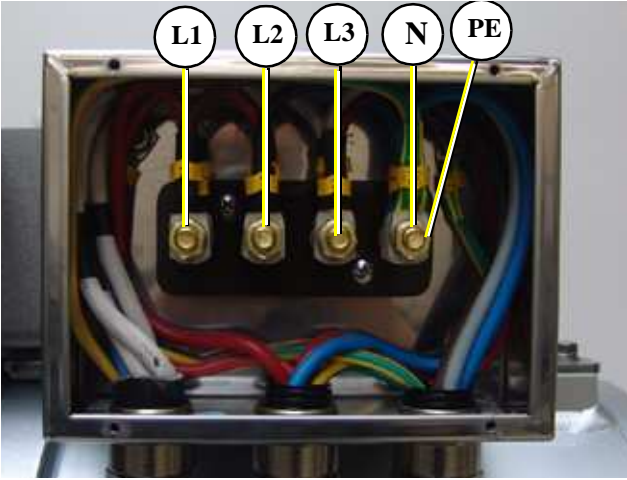

Fig. A.3.7-9: Generator Power Terminal Box 400V/50Hz

Generator Power Terminal Box 120V/60Hz

To locate the Terminalbox see Chapter A2.

In these terminal boxe there are the electrical connection points for the AC generator. Here is also the bridge for the protective grounding of the generator. The cover may only be removed, if it is guaranteed that the generator cannot be inadvertently started.

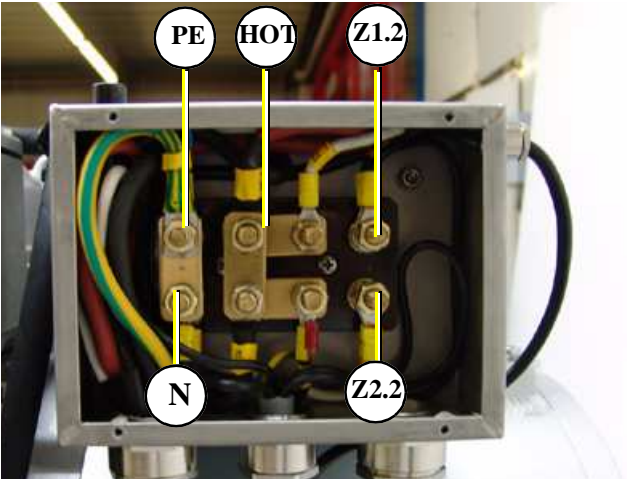

Fig. A.3.7-10: Generator power terminal box

Terminal block for fuses and power relay

- F1 fuse 15A for DC-wiring
- F2 fuse 25A for starter motor
- Ks power relay for starter motor
- K2 power relay for glow plugs
- K3 power relay for fuel pump
- K4 power relay for stop solenoid

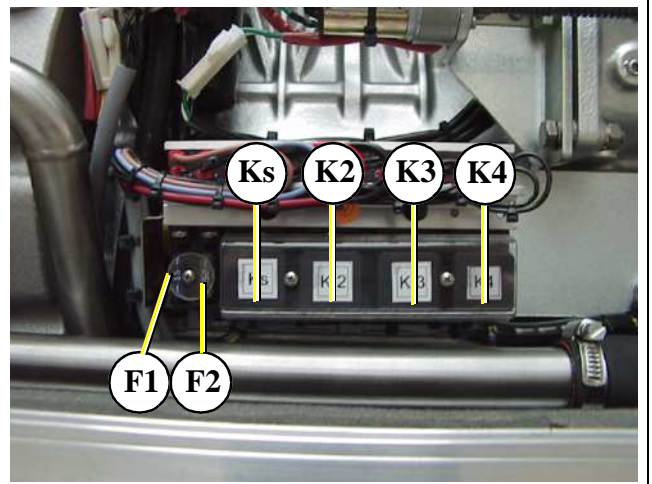

Fig. A.3.7-11: Terminal block

A.3.8 Sensors and switches for operating surveillance

Thermo-switch at cylinder head

The thermo-switch at the cylinder head serves the monitoring of the generator temperature. All thermo-switches for the generators from Panda 6.000 upward are two-pole and laid out as "openers".

110°C and 130°C

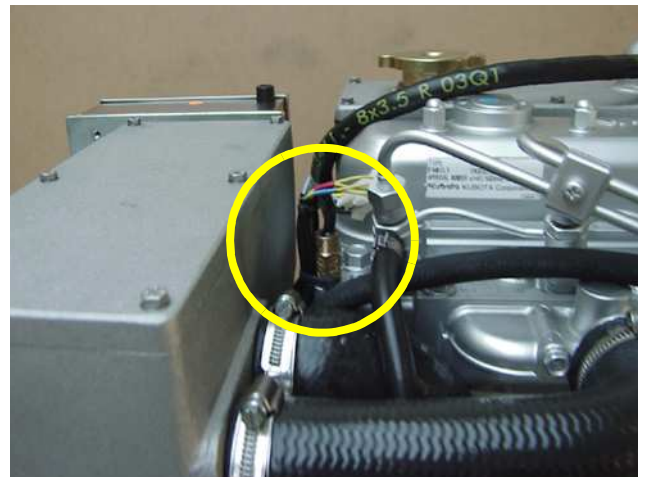

Fig. A.3.8-1: Thermo-switch at cylinder head

Thermo-switch at thermostat housing

98/83°C

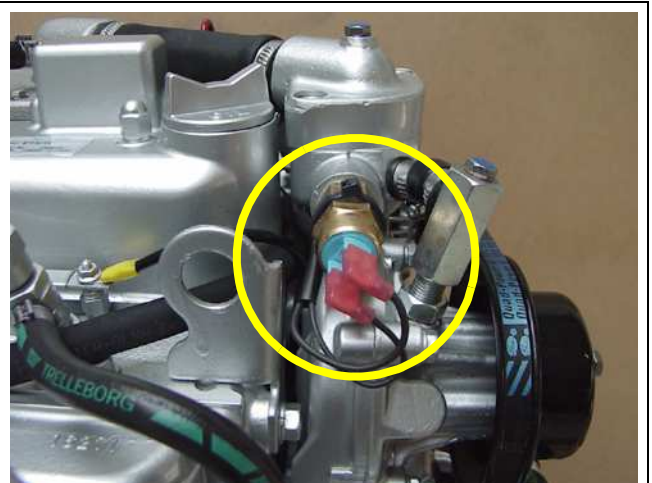

Fig. A.3.8-2: Thermo-switch at thermostat housing

Thermo-switch at exhaust connection

If the impeller pump drop out and delivers no more raw water, the exhaust connection becomes extremely hot.

98/83°C



Fig. A.3.8-3: Thermo-switch at exhaust connection

Thermo-switch at the endshield

The generator bearing is equipped with an oil thermostich, which switches the engine off if the oil temperature becomes to high.

120°C

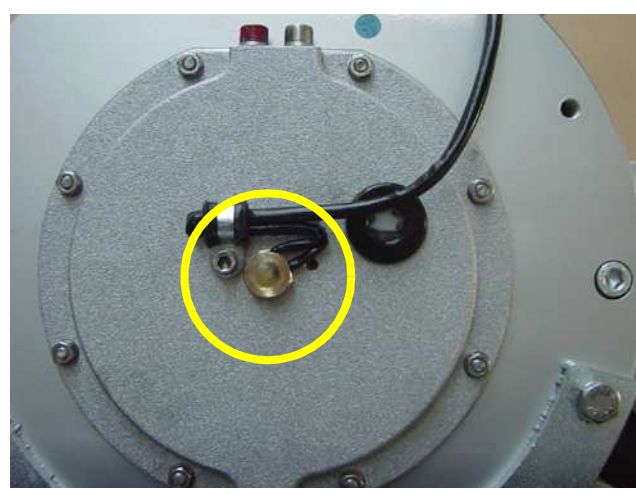

Fig. A.3.8-4: Thermo-switch at endshield

Thermo-switch in the generator coil

- 1. Generator coil
- 2. Thermo-switch 4x160°C
- 3. Housing

For the protection of the generator cil there are two thermo-switches inside the coil, which are for inserted parallel and safety's sake independently from each other.

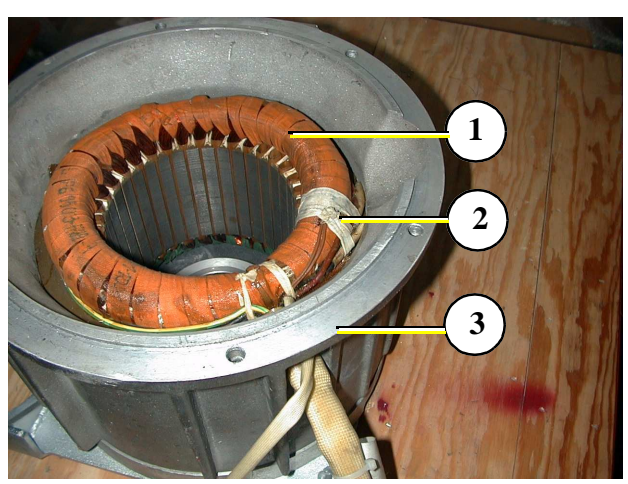

Fig. A.3.8-5: Thermo-switch coil

Oil pressure switch

In order to be able to monitor the lubricating oil system, an oil pressure switch is built into the system. The oil pressure switch is on the back of the engine (next to the DC-alternator).

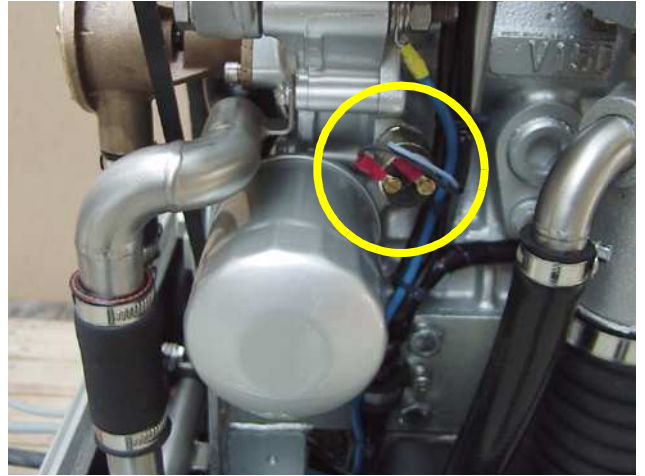

Fig. A.3.8-6: Oil pressure switch

Failure bypass switch

The failure bypass switch offers the possibility of starting the generator if the electrical control switched off due to an error in the cooling system by overheating.



Fig. A.3.8-7: Failure bypass switch

A.3.9 Components of the oil circuit

Oil filler neck with cap

Normally the filler neck for the engine oil is on the top side of the valve cover. At numerous generator types a second filler neck is attached additionally at the operating side. Please pay attention that the filler necks are always well locked after filling in engine oil.

Consider also the references to the engine oil specification.



Fig. A.3.9-1: Oil filler neck with cap

Oil dipstick

At the dipstick the permissible level is indicated by the markings "maximum" and "minimum". The engine oil should be never filled up beyond the maximum conditions.

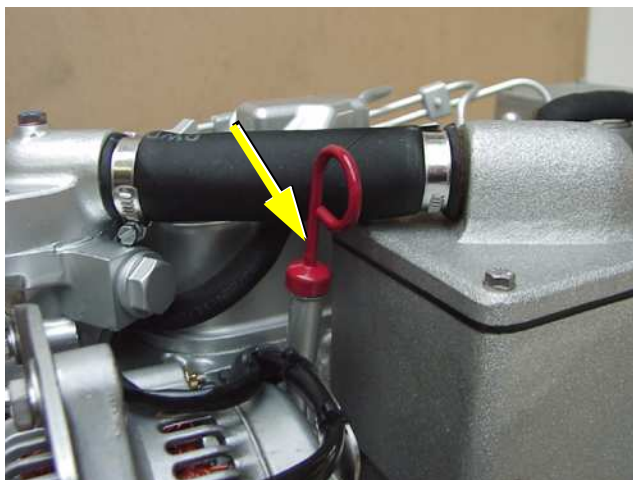

Fig. A.3.9-2: Oil dipstick

Oil filter

The oil filter should be exchanged with an oil change.

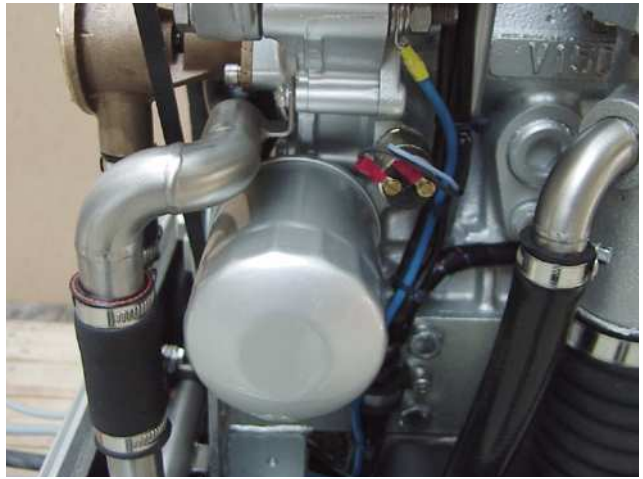

Fig. A.3.9-3: Oil filter

Oil drain hose

The Panda generator is equipped that the engine oil can be drained over a drain hose. The generator should be always installed therefore that a collecting basin can be set up deeply enough. If this is not possible, an electrical oil drain pump must be installed.

Note: Lubricating oil should be drained in the warm condition!

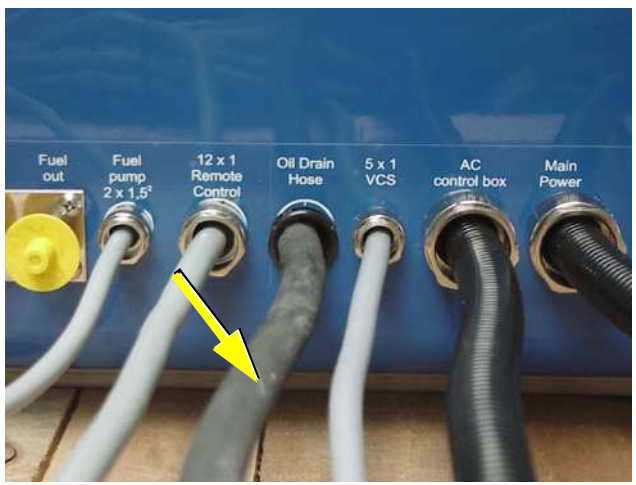

Fig. A.3.9-4: Oil drain hose



A.3.10 External components

External fuel pump

The Panda generator is always supplied with an external, electrical (12V of DC) fuel pump. The fuel pump must be always installed in the proximity of the tank. The electrical connections with the lead planned for it are before-installed at the generator. Since the suction height and the supply pressure are limited, it can be sometimes possible that for reinforcement a second pump must be installed.

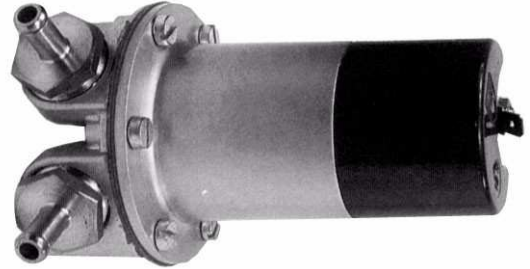

Fig. A.3.10-1: External fuel pump

AC-Control box

At operating the generator the operating voltage of 120/230 and/or 230/400V lies at the AC-Control box. It must be guaranteed that the generator cannot be inadvertently started, if the Control box is opened. For this reason the negative pole of the starter battery is to be disclamped with all work on the electrical system.



Fig. A.3.10-2: AC-Control box

Voltage control VCS

The figure shows the control printed board for the VCS voltage regulation. Over this control printed board the control signals are given for the actuator for speed regulation. On the VCS board are also adjustment possibilities for the control parameters.

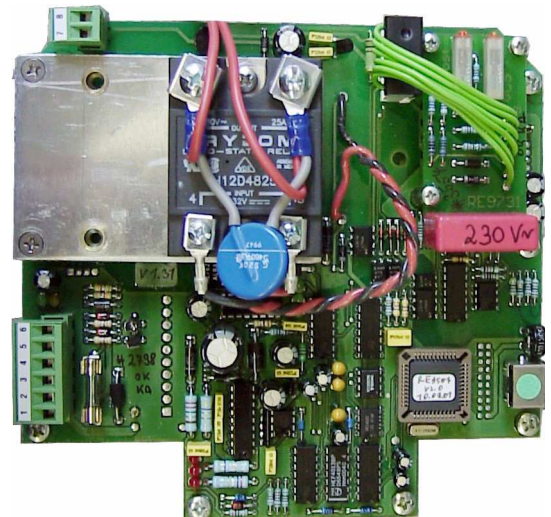

Fig. A.3.10-3: VCS

A.4 Operation manual

A.4.1 Preliminary remark

Pre-heating the diesel motor

The motor must be pre-heated, if the diesel motor is designed as a "pre-combustion chamber motor" for indirect fuel injection. A quick glow fitting is used for all Kubota-diesel motors. If you press the "run/stop" button an automatic pre-glow phase will be activated. After this phase the engine starts.

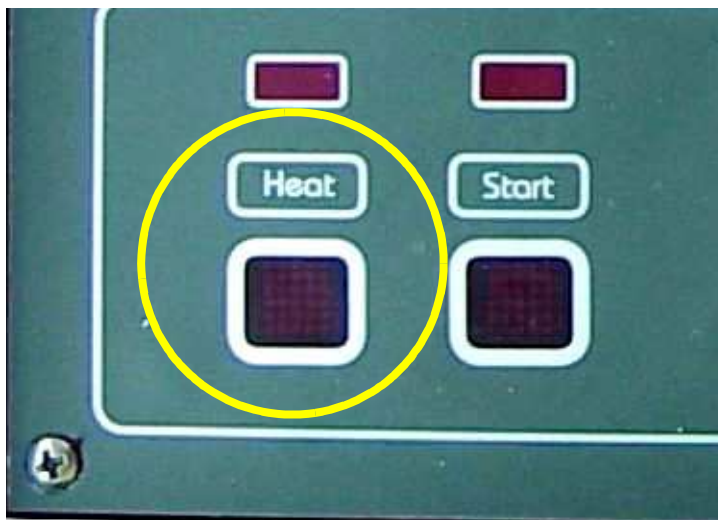

Sample picture

Tips regarding Starter Battery

Fischer Panda recommends normal starter battery use. If an genset is required for extreme winter conditions, then the starter battery capacity should be doubled. It is recommended that the starter battery be regularly charged by a suitable battery-charging device (i.e., at least every 2 Months). A correctly charged starter battery is necessary for low temperatures.

A.4.2 Daily routine checks before starting

1. Oil Level Control (ideal level: MAX).

AtTTENTION! OIL PRESSURE CONTROL!

True, the diesel motor automatically switches off when there is a lack of oil, but it is very damaging for the motor, if the oil level drops to the lowest limit. Air can be sucked in suddenly when the boat rocks in heavy seas, if the oil level is at a minimum. This affects the grease in the bearings. It is therefore necessary to check the oil level daily before initially running the generator. The oil level must be topped up to the maximum level, if the level drops below the mark between maximum und minimum levels.

The oil level of the oil cooled bearing must be checked before every start - see flow glas at the generator front cover!



A.4.2 Daily routine checks before starting (Forts.)

2. State of Cooling Water.

The external compensation tank should be filled up to a maximum of in a cold state. It is very important that large expansion area remains above the cooling water level.

3. Open Sea Cock for Cooling Water Intake.

For safety reasons, the seacock must be closed after the generator has been switched off. It should be re-opened before starting the generator.

4. Check Raw Water Filter.

The raw water filter must be regularly checked and cleaned. The impeller fatigue increases, if residual affects the raw water intake.

5. Check all Hose Connections and Hose Clamps are Leakage.

Leaks at hose connections must be immediately repaired, especially the raw water impeller pump. It is certainly possible that the raw water impeller pump will produce leaks, depending upon the situation. (This can be caused by sand particles in the raw water etc.) In this case, immediately exchange the pump, because the dripping water will be sprayed by the belt pulley into the sound insulated casing and can quickly cause corrosion.

6. Check all electrical Lead Terminal Contacts are Firm.

This is especially the case with the temperature switch contacts, which automatically switch off the generator in case of faults. There is only safety if these systems are regularly checked, and these systems will protect the generator, when there is a fault.

7. Check the Motor and Generator Mounting Screws are Tight.

The mounting screws must be checked regularly to ensure the generator is safe. A visual check of these screws must be made, when the oil level is checked.

8. Switch the Land Electricity/Generator Switch to Zero before Starting or Switch Off all the load.

The generator should only be started when all the load have been switched off. The excitation of the generator will be suppressed, if the generator is switched off with load connected, left for a while, or switched on with extra load, thus reducing the residual magnetism necessary for excitation of the generator to a minimum. In certain circumstances, this can lead to the generator being re-excited by means of a DC source. If the generator does not excitate itself when starting, then excitation by means of DC must be carried out again.

9. Check the Automatic Controls Functions and Oil Pressure.

Removing a cable end from the monitoring switch carries out this control test. The generator should then automatically switch off. Please adhere to the inspection timetable (see Checklist in the appendix).

A.4.3 Starting Generator - see remote control panel datasheet**A.4.4 Stopping the Generator- see remote control panel datasheet****A.4.5 Starting the Generator by a „Failure bypass switch“**

There is a "pressure switch" on the operation side above the power relays. Faults (e.g. caused by overheating) can be manually overcome by means of this switch. The generator can be started by using the remote control panel. The operating temperature can be reduced for a short period of time (without stress of course), so that the fault switch returns to the original position should overheating cause the generator to shut down because of overheating.

ATTENTION: - Before using the failure bypass switch, it is important to check the oil level, since the oil gauge is deactivated by the switch. For a further reason it is important to switch off the generator electrical load before the generator is shut down:

Before stopping the generator it is highly recommended that electrical devices (e.g. refrigerating compressors, air conditioning compressors etc) are switched off, because the voltage drops as the rotational speed (rpm) decreases as the engine comes to a halt.

(Also see information regarding voltage control with automatic shut-off for protection of load when over or undervoltage occurs).

This is also the case when the generator is started when load is switched on.

Normally the generator will no longer excite if a certain amount of base load is stepped up. The electrical load should also be shut-off before starting the generator.

If started under electrical load, the engine will still run but the generator will not generate the proper voltage (or even no voltage) since the stator windings do not have the chance to reach full excitation. Electrical units which are switched on in this condition could possibly be damaged (special caution should be practised with electric motors to avoid burnout).

B. Generator Failure

B.1 Tools and Measuring Instruments

In order to be able to manage disturbances while driving, the following tools and measuring instruments should belong to the equipment kept on board:

- Multi-meter for voltage (AC), frequency and resistance
- Measuring instrument for inductance
- Measuring instrument for capacity
- Current absorbing clamps
- Thermometer (ideal is a infra-red thermometer)
- Pressure device (pincer) for coolant circuit

B.2 Overloading the Generator

Please ensure that the generator is not overloaded. This must be considered, especially with regards to multi power generators. In this case the extra load including the electrical performance can be considerably greater than the drive performance of the motor, which can eventually lead to a damaged motor.

The full nominal performance of the generator is fore-mostly for short term use. It is, however, required to start electric motors with high starting current or achieve special starting procedures at peak loads. 70% nominal load is ideal for a long motor life. (Continual use means uninterrupted use of the generator for many hours). This should be taken into consideration when connecting devices. This ensures extended motor life.

It is no problem for the motor to be run occasionally for 2 - 3 hours at full load. The complete conception of Panda Generator ensures that even during extreme conditions, an overheating of the motor will not occur. Accumulation of soot will occur if run for long periods at full load.

Effects of Short Circuiting and Overloading on the Generator

The generator cannot be damaged by short-circuiting or overloading. Short-circuiting and overloading suppress the magnetic excitation of the generator, thus, no current is generated and the voltage will collapse. This condition is immediately offset, once the short circuit has been eliminated and/or the electrical overload removed.

Overloading the Generator with Electric Motors

With the operation of electric motors it must be considered that these take up a multiple of their rated output as starting current (six to tenfold).

If the power of the generator for the engine is not sufficient, the voltage in the generator breaks down after switching on the engine. For special approach problems the manufacturer can give recommendations regarding the accomplishment of the situation (e.g. amplified condensers, gradual start switch or extra developed starting unit for electric motors).

The system efficiency can be improved up to 50 % and the starting current can be improved up to 100 % by a professional adjustment of the engines. If the inductive load (electrical motors etc.) lies over 20 % of the generator rated output compensation is appropriate (see in addition also the writing: "Operation Instructions for Generators with Inductive Loads").

B.2.1 Monitoring the Generator Voltage



ATTENTION!
see "Safety Precautions" on Page 13.

The voltage range of the power stations normally lies between 200 and 240 V (100 - 130 V in the 60 Hz version). In some countries even substantially larger tension deviations are being called "normally". The Fischer Panda generators are aligned that they keep these default values during normal load.

With high load or overload it can occur that the voltage drops on 190 V (95 V in the 60 Hz version) and partly still more deeply. That can become critical for certain devices (e.g. for electric motors, cooling compressors and possibly for electronic devices). It must be paid attention that the voltage for such consumers are sufficient. This can be supervised by a voltmeter.

The voltmeter should be always installed behind the change over switch generator/land power, so that each voltage source is shown. No further voltmeter is provided for the generator itself.

If additional consumers are switched on, the voltage must be controlled in each case at the voltmeter. Sensitive devices must be switched off so long, until the voltage exceed the critical parameter.

Under certain circumstances the generator provides overvoltage. This arises if the number of revolutions of the generator is increased. Changing the number of revolutions may be made only with a tachometer and/or a voltmeter.

If sensitive and/or valuable devices are used, which are to be protected against this risk, an automatic overvoltage protection must be mounted (voltage control with disconnection).

B.2.2 Automatic Voltage Monitoring and Auto-Shut Down

If air conditioning units (compressors) or other such valuable equipment is installed on-board, it is recommended that an automatic voltage monitoring unit be installed to protect this equipment from possible sharp voltage drops. The voltage monitoring system shuts down the entire system (and therefore all users) by means of a circuit breaker relay as soon as the voltage falls below a set value (the monitor will also shut down the on-board grid automatically when the generator is stopped). Such a relay with contactor can be obtained from the installer or as a complete unit from your Fischer Panda dealer.

B.3 Setting the Speed Governor of the Actuator

The speed of the generator is determined by two independent settings; an upper and lower speed governor:

- By means of the adjusting nuts on the spindle of the servomotor right and left from the spindle nut (Setting of the normal speed limit).
- By means of an adjusting screw that is located on the base of the speed control lever. (Setting of the maximum upper speed).

After working on the components of the actuator, the speed must be checked.

1. Servo motor
2. Trapezoidal Thread Spindle
3. Adjusting nuts for max. speed
4. Spindle nut with speed adjusting lever
5. Adjusting nuts for the lower setting

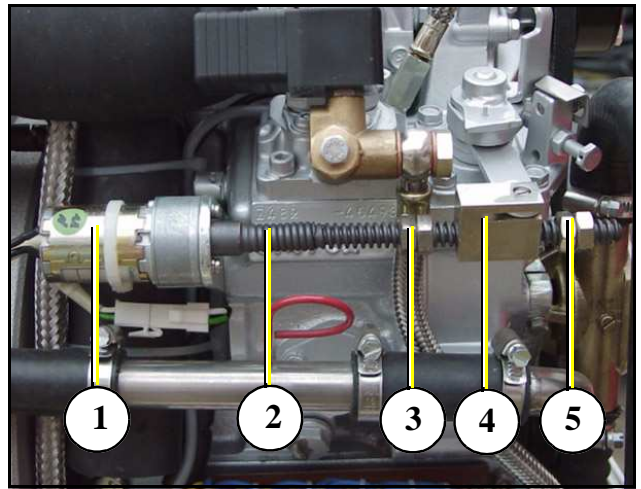

Fig. B.3-1: Actuator

During any operation at the generator all consumers have to be switched off to avoid damages at the equipments. Also the solid state relay, which is installed in the AC control box must be disconnected to avoid an accidentally activation of the booster capacitors.

B.3.1 Setting the maximum upper speed setting

1. Remove the plug from the electrical input for the actuator.
2. Loosen the counter nuts of the speed governor screws with a combination wrench SW 10.
3. Connect a voltmeter with a range up to 300 Volts AC to the AC Output of the AC Control Box.
4. Ensure that no electrical load has been set.
5. Start generator.
6. Raise the speed of the generator by turning the spindle of the servomotor until the voltmeter reaches 260 Volts (130 Volts).
7. Turn the governor screw firmly against the stop setting of the speed adjustment lever.
8. Secure the governing screw by means of the counter nut.
9. Once again check whether the generator voltage is governed to 260 Volts (130 Volts).

The upper speed settings serve as an additional safety factor. The value for the maximum voltage is therefore approx 5 volts above the normal running limit.

1. Counter nut
2. Adjustment screw for upper setting
3. Speed Adjustment Lever

This setting should not be changed otherwise the guaranty will expire.

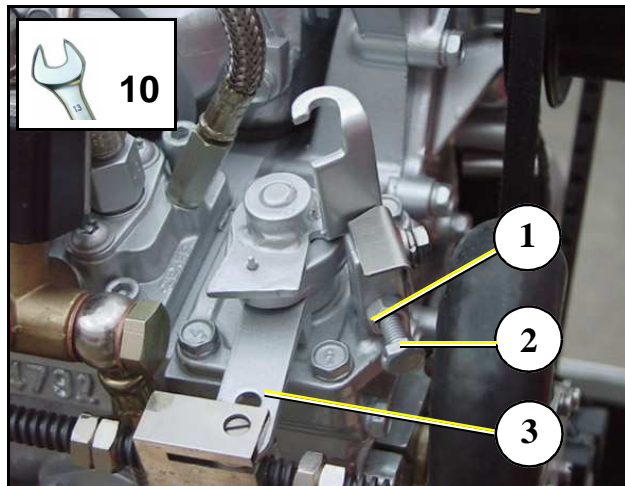

Fig. B.3.1-1: Counter nut, Adjustment screw and speed adjustment lever

B.3.2 Setting the normal speed settings

Setting the lower speed limit

1. Remove the plug from the electrical input.
2. Loosen the counter nuts against each other by means of two combination spanners SW 10.
3. Connect an electrical voltmeter in the range up to 300 Volt AC to the AC Control Box output.
4. Ensure there is no electrical load.
5. Start generator.
6. By turning the servo meter spindle downwards by hand until the voltmeter shows a value of 225 volts (110V).
7. Tighten both nuts tightly against each other.
8. Once again check whether the lower generator voltage of the generator without load is limited to 225 volts (110 volts).

Setting the upper speed limit:

1. Continue as above and tighten the counter nuts at a voltage of max. 260 volts (130 volts).
2. Once again check whether the upper generator voltage without load is limited to 260 V (130 V)

1. Adjustment screw for the upper speed limit
2. Adjustment screw for the lower speed limit

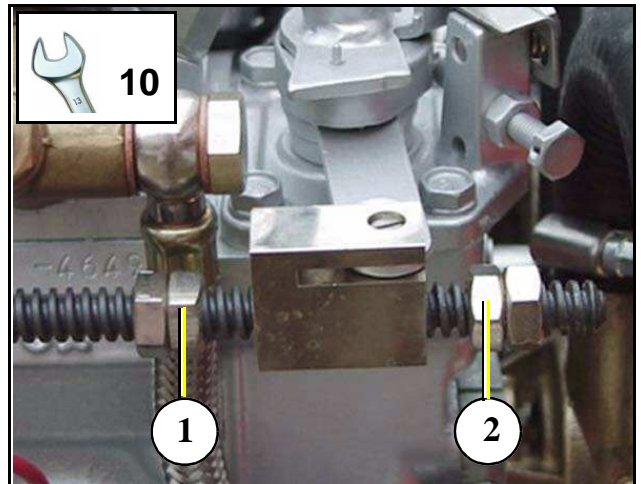

Fig. B.3.2-1: Adjustment Screw Speed Governor

The electrical plug must be reconnected to drive the actuator servo motor, once the adjustment has been completed.

The connection must be remade should the electrical input wires have been removed from the AC control box.

B.3.3 Greasing the trapezoidal thread spindle on the speed actuator

(The speed setting of the trapezoidal thread spindle must be regularly greased. Only high temperature-resistant grease (up to 100 °C) may be used. The end of the nuts must also be smeared with grease.

If the spindle has not been sufficiently greased, then it can jam. The generator then cuts out when over or under-heated.

All screws on the rotary servomotor and the spindle should be secured with a screw securing solution, so that they can be easily loosened.

The trapezoidal thread spindle must be checked, if the generator has cut out, because of under or over voltage.

Servicing intervals also includes the checking of cut out functions in cases of defect. Only by making regular checks can it be ensured that the generator switches off, if there is a fault. The generator will not switch off, if the cut out control of the solenoid valve does not function.



1. Speed actuator
2. Trapezoidal Thread Spindle

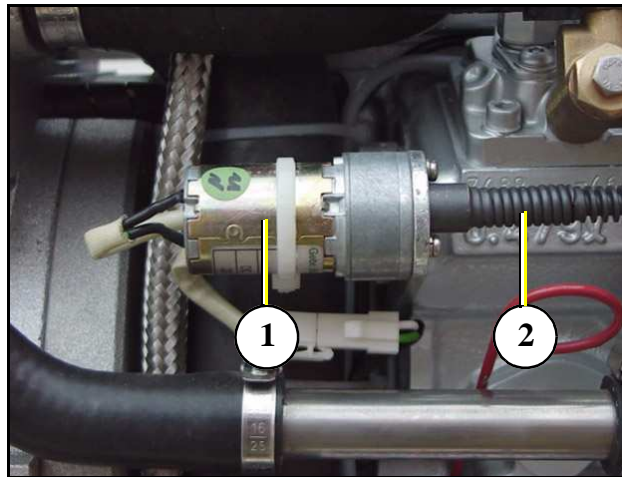

Fig. B.3.3-1: Trapezoidal Thread Spindle

B.3.4 Consequences of a continual overloading of the Actuator

If the generator is overloaded the voltage falls on account of a not adequate motor power under the nominal value. The actuator stays at the upper keystroke and tries to rev up the diesel engine. An internal regulation limits the current to the actuator, nevertheless a longer overload can damage the winding of the actuator. (short of the winding). The motor gets not strictly inoperative but it can happen that the cranking torque of the actuator is getting weak. This has the consequence that the rev spindle can not be turned to all positions faultless. Therefore the voltage of the generator is regulated not good or sometimes not at all.

If the generator is overloaded, the voltage falls under the nominal value due to insufficient engine power. The actuator is already at the upper speed limit and still tries to rise the rev. speed of the engine. There is an internal control which limits the actuator current, but an overloading over a longer period of time can still damage the winding of the actuator.

This will not effect the operation ability of the engine, but it can happen that the cranking torque of the actuator is getting weak. This has the consequence that the rev. spindle can not be turned to all positions correctly. Therefore the voltage regulatiron of the generator is very bad or the generator is temporarily not beeing regulated at all.

If you should notice that the actuator for the spindle sometimes does not run smoothly, then a check must be made to determine whether the generator has been effectively overloaded for periods, therefore causing damage to the internal winding of the actuator. The actuator must then be exchanged.

The electrical fuses on the circuit board must be checked, if the actuator for controlling the speed does not turn.

Change this fuse
(1,6 A slow to blow)

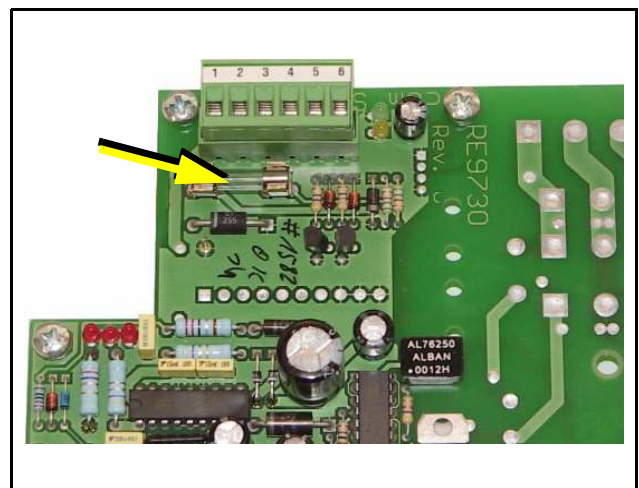

Fig. B.3.4-1: Fuse for the actuator at the remote control panel

True, overloading cannot damage the actual generator, since the windings are safe from overloading and short circuiting, but damage is always possible to peripheral consumers. This is especially the case for connected consumers, which can easily be damaged because of current that is too low.

Check the voltage control if there is a fault	
Problem	Possible Cause
The spindle of the actuator jams	<ul style="list-style-type: none"> • Not regularly lubricated. • Surface has mechanical damage. • Actuator is defective (evtl. winding short cut). • Defect of the VCS control. • Signal 230 V (115 V) AC missing. • Limiting nut jams the spindle.
Fuse on the printed circuit board of the VCS control is melted.	<ul style="list-style-type: none"> • Constant overload of the generator.

Steps to check the voltage control in case of a failure:
<ol style="list-style-type: none"> 1. Switch off all electrical consumers. 2. Remove plug from the actuator. 3. Turn the actuator by hand to determine whether the adjusting nut has jammed against the speed governor. 4. Turn the actuator by hand to check whether the adjusting nut runs smoothly on the spindle. <p>If the above test produces no result, it can be assumed that the actuator operates smoothly. The electrical groups of components must then be checked:</p> <ol style="list-style-type: none"> 1. Re-connect plug. 2. Start generator. 3. Turn the actuator by hand to check whether the Spindle is reversed by the motor. 4. It can be assumed that the actuator is faultless, if the turning of the actuator is too much for the hand (It is not normally possible to stop the motor with the fingers). It must be assumed that there is a fault with the voltage control (VCS).

The following measures are necessary if the actuator is jammed:
<ol style="list-style-type: none"> 1. If the actuator only turns weakly: <ul style="list-style-type: none"> • Actuator has a destroyed winding and must be exchanged. (In future it should be ensured that the generator is not overloaded). 2. If the actuator does not move, but the spindle can be turned by hand: <ul style="list-style-type: none"> • Remove plug from the actuator and temporarily connect it to an external 12 volt direct current source. The motor is defective if the actuator still does not turn when connected to the external electrical source. Exchange the motor.

The VCS circuit board should be exchanged if these measures do not produce clarity.

Checking the generator voltage limitation

The mechanical voltage limitation must be checked regularly.

1. Switch off all consumers.
2. Disconnect the plug of the actuator.
3. Connect an electrical voltmeter.
4. Start the generator.
5. Turn the actuator to the lowest limit point by hand. The max. voltage is 260 V (130 V).
6. The voltage must be 225 V (110 V).
7. Turn the actuator to the upper limit by hand. The max. voltage is 260 V (130 V).
8. A new adjustment is necessary in case of deviants.

B.4 Generator-Output Voltage is too low

If the AC generated is too low, then the consumers should be disconnected, one after the other, in order to reduce the load on the generator. Generally the problem is then solved. The frequency should be checked, if the output voltage is correct after the consumers have been disconnected. Should this be above the prescribed generator idling speed, it can be assumed that one or several condensers are defective.

B.4.1 Discharging the Capacitors



ATTENTION! Never work on the control box, if the generator is running!
Do not touch the capacitors contacts, see "Safety first" on Page 10.

1. Switch off the generator.
2. Remove the starter battery.
3. Open the AC-Control Box.

The capacitors are discharged by short fusing both contacts. The contacts (Flat plug) can be bridged by means of a screwdriver with an insulated handle (short-circuiting).

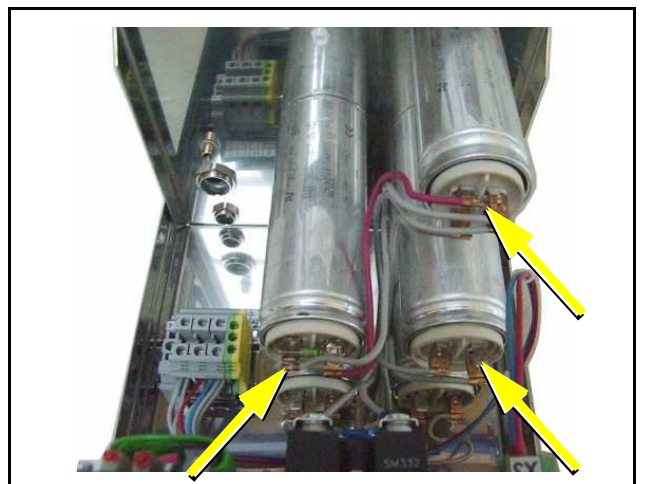

Fig. B.4.1-1: Capacitors

B.4.2 Checking the Capacitors



ATTENTION: If the capacitors are to be checked, make sure that the capacitors has been discharged.

A visual check can give information on whether the capacitors are defective:

- Dielectric leak?
- did the capacitor become longer?

The capacitors can be tested with a multi-meter. Switch the measuring instrument to "pass" and connect both connections of the capacitors to the connections at the measuring instrument.

Touch the two contacts of the capacitors by means of the test prods. A charge should be fed to the capacitor by the internal battery.

The capacitors can be tested by means of a multi-meter, which is fitted with a buzzer. The multi-meter should be switched to open and both capacitor connections connected to the multi-meter.



Fig. B.4.2-1: Multimeter

Should a steady sound or no sound be heard, the capacitors are defective and must be replaced.

A capacity measuring instrument must be used in order to check whether the capacitors have full capacity.

The capacitors, which do meet the prescribed capacity value at this measurement, should be exchanged as fast as possible. If all capacitors prove to be still functional, then a check must be made, as to whether the connections to the strip are correct.

Checking the electrical connections to the capacitors

It must be ensured that the electrical connections to the capacitors are always tight fitting. Loose connections with transitional resistance can mean that the contact surfaces will become heated externally. This can lead to an increased deterioration of the capacitors.

B.4.3 Check the Generator Voltage

The following steps must be taken, in order to test whether the stator winding generates sufficient voltage:

1. The following steps must be taken, in order to test whether the stator winding generates sufficient voltage:
2. Ensure that the connection to the shipboard circuit is interrupted.
3. Remove all electrical wires in the generator junction box.
4. Starter battery must be connected to the generator.
5. Start generator.
6. Measure the current between the phases and neutral. It can be assumed that damage has been caused to the windings, if the measured values are below the values given in Table 5 on Page 110

Both partial windings must be connected for the 60Hz Version, i.e. there must be a connection made between wire 1 and 3 (see circuit plan).

(Note: The current arises from the rest magnetism of the rotor, which induces a voltage in the winding).

B.4.4 Measuring the Ohm Resistance of the Generator Windings

If a short circuit could not be found by using a multi-meter, then the windings parts of the generator must be checked by means of an Ohmmeter that is suitable for low resistance values.

- Set the measuring device to measure resistance. If you hold the poles of the measuring device against each other, then 0.00 Ohms should be shown. If the pole has been isolated then the display should show an overflow. Please carry out this test to check the device.
- Measure the resistance within the individual windings.

If there are large deviations, it must be assumed that there is a windings short circuit. This also leads to non-excitation of the generator.

The actual values between the windings parts and the earth cannot, however, be exactly determined. Fore-mostly, the values of all three measurements must be the same, if possible. Deviations from each other show there is windings short-circuit. In this case, the generator windings must be renewed by an electrician.

B.4.5 Check the Windings for Short Circuiting

Ensure that the generator has been switched off and cannot be inadvertently switched on. Disconnect the wires to the battery for this.

1. All wires in the junction box or - if necessary - in the circuit distribution box must be disconnected. Ensure that the wires are no longer carrying an electrical current, before being disconnected (see "Discharging the Capacitors" on Page 51.)
2. Remove the Bridges between "N" and "PE", so that the windings and casing do not come into electrical contact.
3. Make a check, by means of a Multimeter, as to whether there is a current between the individual winding terminals and the casing (PE).

The contacts to measured are not relevant to the type of generator (see type plate):

HP1 - 50 Hz: L, Z

HP1 - 60 Hz: L, Z

HP3 - 50 Hz: L1, L2, L3

HP3 - 60 Hz: L1, L2, L3, 1, 2, 3, 4

DVS - 50 Hz: L1, L2, L3, L1'

DVS - 60 Hz: L1, L2, L3, L1', 1, 2, 3, 4

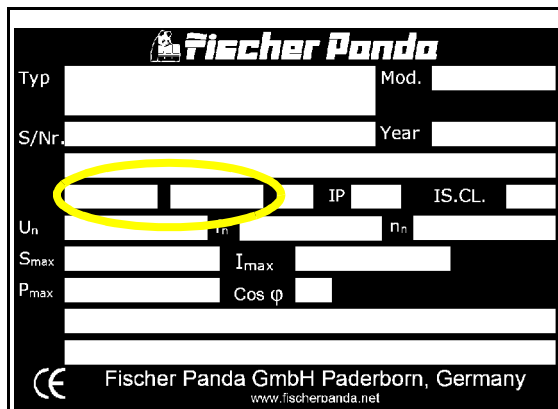

Fischer Panda

Typ	Mod.
S/Nr.	Year
IP	IS.CL.
U_n	n_n
S_{max}	I_{max}
P_{max}	$\cos \phi$

Fischer Panda GmbH Paderborn, Germany
www.fischerpanda.net

The generator must be sent for a check to the factory or be re-winded locally, when a pass (beep) should be determined. Windings data can be requested for this, if it is necessary.

Fig. B.4.5-1: Generator type plate

B.4.6 Measuring the Inductive Resistance

An Ohm measurement of a winding does not always give reliable information concerning the state of the winding. If there are resistance irregularities between the windings parts, this is a sure sign that the winding is defective. This means the opposite cannot be concluded. This means a winding can also be defective, if the resistance values between the windings parts do not show great deviation.

Measurement of the inductive resistance gives a better reading. A Special measuring device is necessary for this.

The inductivity is measured in the same manner as the resistance, i.e. the windings parts are compared. The value of the inductive resistance is given in mH (milli Henry).

The correct values for the inductive resistance can be obtained from Table 4 on Page 110.

Note: The values are greatly dependent upon the measuring method (type of ohmmeter).

B.5 Generator provides no voltage

B.5.1 Rotor Magnetism Loss and "Re-magnetising"



ATTENTION! "Safety Instructions" on Page iv

In the case of asynchronous generators, the generator cannot independently increase voltage after standing still, or, if it is switched off under full load. This is because the rotor has lost its remaining magnetism.

This remaining magnetism can be restored simply by use of a DC battery. In addition the "shore power" must be switched off and any connection to an AC-source must be interrupted.

Likewise the generator must be switched off, i.e. also the starter may not be operated. The power source selector is switched to "generator". Only the plug socket must be connected with the generator.

Now the two poles of a 9 Volt battery are connected to the plug socket or held against the appropriate contacts of the on-board current distributor. Do not use a battery bank or the generator starter battery, this could damage the winding. The DC voltage only may be applied for a short time (1-2 seconds). In the winding the remaining magnetism is restored by a short current pulse, and the generator can normally be started.

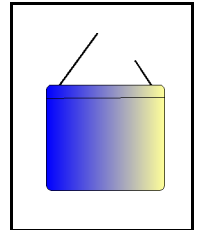

B.6 Engine Starting Problems

B.6.1 Fuel Solenoid Valve

The fuel solenoid valve is located in front of the injection pump. It opens automatically, if the "START"-button is pressed on remote control panel. If the generator is switched to "OFF", the solenoid valve closes. It takes some seconds, before the generator stops.

If the generator fails to start, runs rough, does not reach the proper RPM, or does not stop properly, the first item to suspect in most cases it is the fuel solenoid valve and should be inspected first.

A check of the fuel solenoid valve by removing the plug from the fuel solenoid valve for a short period whilst in operation (first remove the small retention screw) and replace it immediately. The motor should "react immediately" by revving high. If the motor does not react sharply to the reconnection of the solenoid wire, it is a sign that the solenoid valve could be faulty.

1. Fuel solenoid valve
2. Fuel injector
3. Ventilation screw

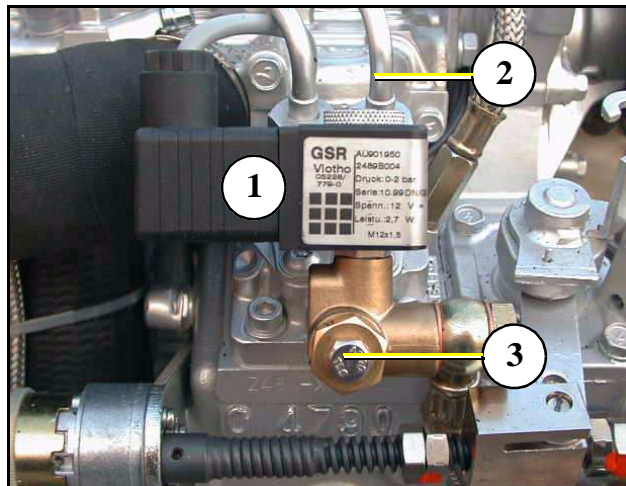

Fig. B.6.1-1: Fuel Solenoid Valve

B.6.2 Re-start with Failure Bypass Switch

The start-failure bypass switch enables an immediate restart facility of the generator, should it cut out, even if this was caused by over-heating. There is normally a requirement to wait until the motor has cooled down to the correct temperature. This can last for several hours in certain circumstances, since the generator is enclosed in a sound-insulated casing, which prevents heat loss.



Failure Bypass Switch

Fig. B.6.2-1: Failure Bypass Switch

This period can be reduced by pushing the button on the front of the generator. The generator can be started by means of the remote control as long as the button is depressed. The switch/button bypasses any faults allowing the generator to run.

Before depressing the button, a manual check of the oil dip stick must be carried out to determine whether the generator has sufficient oil, as it is possible that the oil pressure switch causes the generator to cut out. If it has been ascertained that the reason for the motor cutting out is overheating and not lack of oil, the generator can be run for several minutes without load, so that the motor is cooled by the circulating coolant.

BEWARE:

If the temperature is the reason for the generator cutting out when it is running under load, then an immediate check must be made to determine the cause. It could be a fault with the cooling system, one of the fans, the air-intake or a fault with the external cooling system.

Continual use of the starter-failure bypass switch should be avoided, while the generator cuts out during operation.

The generator must always run without load for several minutes before being switched off, so that temperature compensation occurs. Heat accumulation can cause the generator to overheat, even after it has been switched off.

Should the overheating alarm be set off, caused by heat accumulation, after the generator has been switched off, then this can also be bypassed using the switch.

Damage to starter motor

The starter is fitted with a free wheel or axial rotating spring cog, which prevents the starter being driven externally by means of the motor. The free wheel will be heavily worn, if the starter still operates, thereby causing damage to the springs, roller bearings or cog teeth. This could lead to complete destruction of the starter.

It is important that every person who operates the generator is informed of this situation. This is practically the only handling error that can be made on board that can lead to fatal consequences for both generator and operator.

B.6.3 Troubleshooting Table

For Troubleshooting see Table "Troubleshooting" on Page I.

Blank

C. Maintenance Instructions

C.1 General maintenance instructions

C.1.1 Checks before starting

- Oil level
- Cooling system leaks
- Visual check for any changes, leaks oil drain system, v-belt, cable connections, hose clips, air filter, fuel lines

Once a month

- Grease/oil the servo motor - Trapezoid thread-Spindle

Maintenance intervals siehe "Inspection checklist for services" auf Seite 117.

C.1.2 Check of Hoses and Rubber Parts in the sound insulated capsule

Check all hoses and hose connections for good condition. The rubber hoses are very sensitive to environmental influences. They wear quickly in an environment of dry air, oil and fuel vapours, and high temperatures. The hoses must be checked regularly for elasticity. There are operating situations, when hoses must be renewed once a year.

Additionally to usual tasks of maintenance (oil level check, oil filter control etc.) further maintenance activities are to be accomplished for marine generators, such as control of the sacrificial anode (cooling water connection block) and the front seal cover at the generator.

C.2 Oil Change Intervals

The first oil change is to be accomplished after a period of operation from 35 to 50 hours. Afterwards the oil is to be changed after 100 hours. For this the oil SAE30 for temperatures over 20°C and SAE20 for temperatures between 5°C and 20°C is to be used. At temperatures under 5°C oil of the viscosity SAE10W or 10W-30 is prescribed.

C.3 Execution of an oil change

Oil drain hose

For the oil change an oil drain hose is fed through the sound insulation capsule.

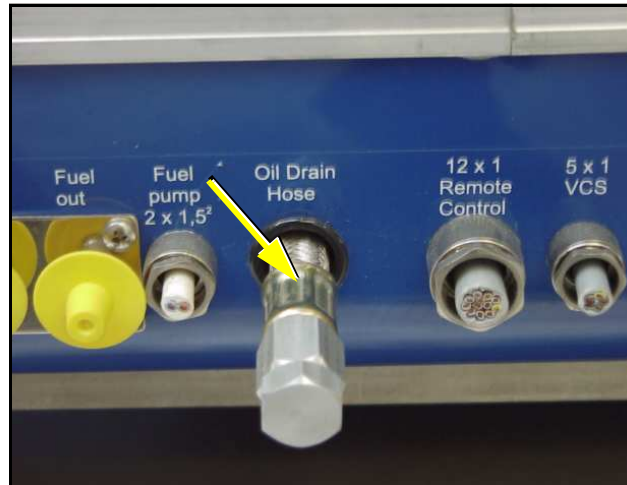

Fig. C.3-1: Oil Drain Hose

Oil Drain Screw

The oil can be discharged by opening the oil drain screw. For countering use a second wrench.

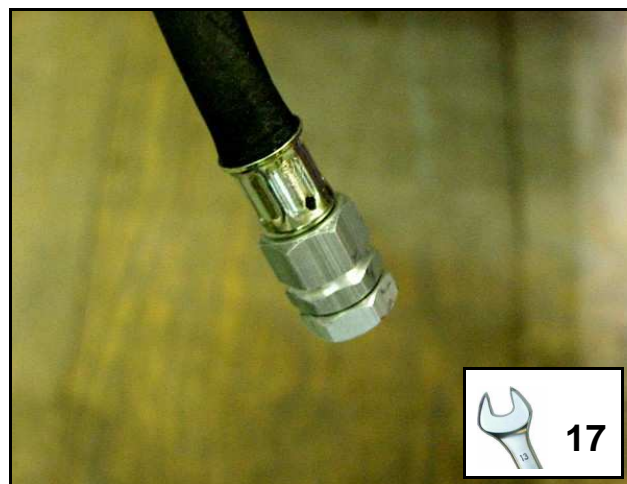

Fig. C.3-2: Oil Drain Screw

Oil Drain Pump

If drainage of the oil is not possible, we recommend the employment of a hand pump, which can be attached to the oil drain hose.

Close the oil drain screw.



Fig. C.3-3: Oil Drain Pump



Oil Filter Change

The oil filter can be loosened by means of an oil filter strap.

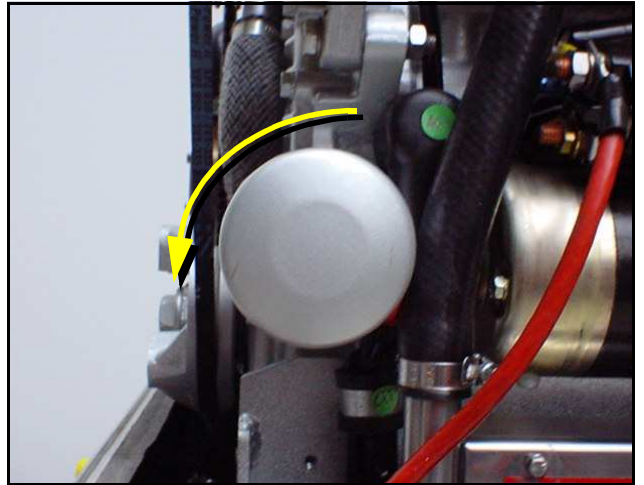

Fig. C.3-4: Oil Filter Change



Oil filter gasket

The gasket should be coated with oil before inserting the new oil filter.

Tighten the oil filter by hand only.



Fig. C.3-5: Oil Filter Gasket



Refill Oil

New oil is poured in, after opening the cap of the oil filler neck. Please wait a moment, before measuring the oil level; the oil must first settle in the sump.

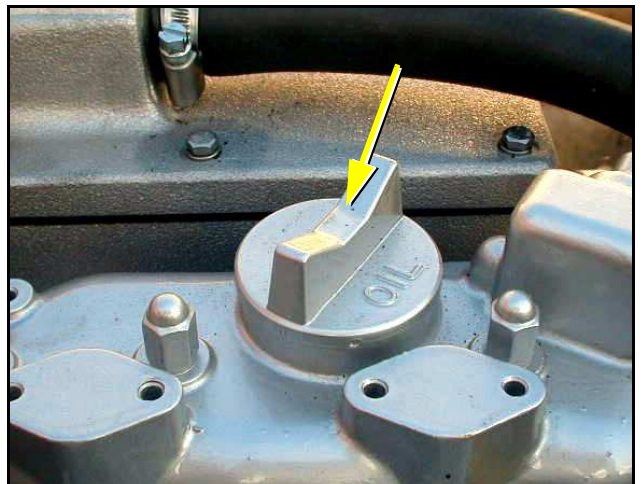

Fig. C.3-6: Oil Filler Neck



Oil Dipstick

The oil level is checked by use of the engine oil dipstick. The prescribed filling level may not exceed the "Max" marking.

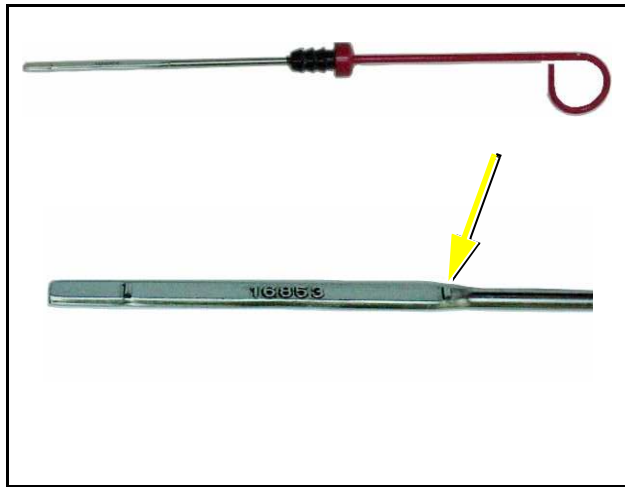

Fig. C.3-7: Oil Dipstick

C.3.1 Check Oil Level of the Oil-Cooled Bearing



The oil level of the oil-cooled bearing must be checked regularly.

C.4 Checking the water separator in the fuel supply

The pre-filter with water separator has a cock underneath, by which means the water can be drained.

This water sinks to the bottom, due to its density. It is heavier than the diesel



Fig. C.4-1: Pre-filter with water separator

C.4.1 Ventilating the Fuel System

Normally, the fuel system is designed to ventilate air itself i.e. as soon as the electric starter motor starts operation the fuel pump starts working and the fuel system will be de-aerated after some time automatically. It is nevertheless essential to ventilate the system as follows prior to the first operation (as all hoses are empty):

1. Main power switch "OFF"

2. Press failure bypass switch and keep firmly pressed. The electrical fuel pump must be audible. Switching on and off the solenoid valve at the generator will be audible by pressing the failure bypass switch (if capsule removed).

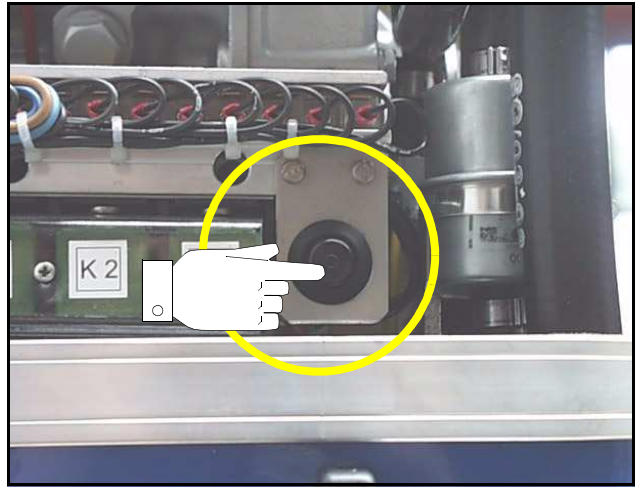

Fig. C.4.1-1: Failure Bypass Switch

3. Pressing the failure bypass switch for approx 3 - 4 minutes will loosen the ventilation screw located at the fuel solenoid valve. The button must continue to be pressed, whilst opening the screw. A large cloth or Kleenex tissue must be laid beneath the connection to prevent escaping fuel running into the capsule. If the fuel runs out without air bubbles, then the ventilation screw can be closed. Only then may the button be released.

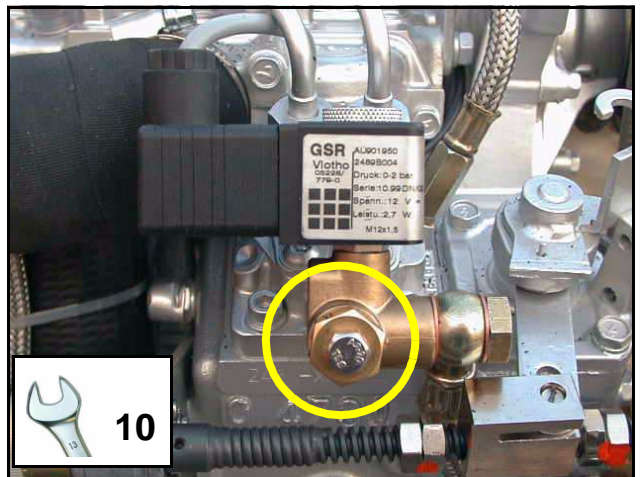

Fig. C.4.1-2: Ventilation Screw at the fuel solenoid valve

4. Pressing the starter button can now start the machine. The machine should start after a short period.
5. If this does not occur, then a connecting nut fitted to the injection line must be loosened and starting procedure repeated. Retighten the washers after successfully starting. The injection line must be raised by several millimetres.
6. Switch main switch "OFF"

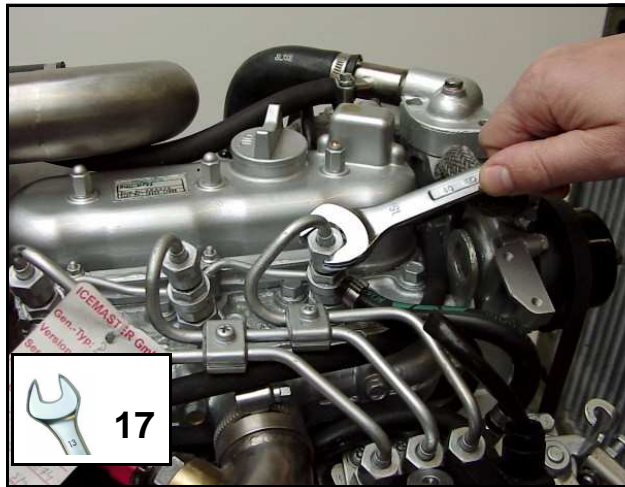

Fig. C.4.1-3: Injection nozzles

C.4.2 Exchange of the Fuel Filter

Exchanging the filter, depending upon fuel contamination, should take place after 300 operational hours at the very least. The inlet must be clamped, before exchanging the filter.

Remove the hoses from the used filter and fasten them to the new filter. The arrow on the filter housing indicates the direction of the fuel flow. A clogged filter causes a decreased power output of the generator.



Fig. C.4.2-1: Fuel Filter

C.4.3 Exchange the Air Filter Mat

1. Open the air suction housing by loosening the six screws on the housing cover.

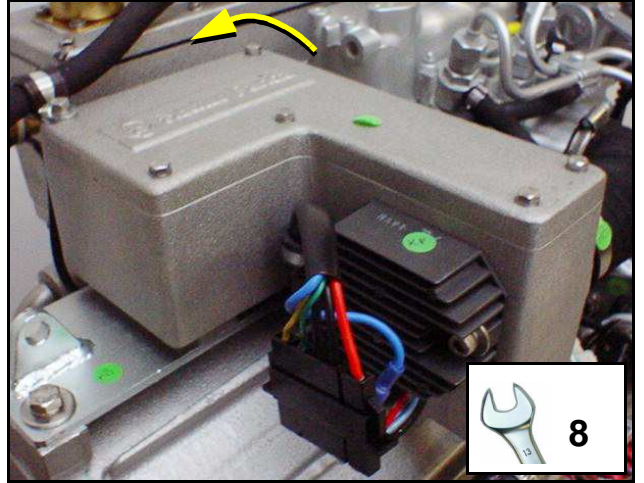

Fig. C.4.3-1: Air Suction Housing

2. Change the air filter mat
3. Close the suction air housing



Fig. C.4.3-2: Opened Air Suction Housing

C.4.4 Ventilation of the Coolant Circuit / Freshwater

Special notes for the ventilation of the cooling system

If the cooling water is drained, or if other air has entered the cooling system, it is necessary to ventilate the cooling system. This ventilating procedure must be repeated several times:



ATTENTION! The generator must be switched off before opening the ventilating points!

Pay attention that the external coolant expansion tank is connected with the generator by the intended connection point.

Further it should be guaranteed that the expansion tank is attached in sufficient height (600 mm) over the level of the generator exhaust elbow union.



Fig. C.4-1: Expansion Tank

1. Open the ventilating screw above the cooling water pump casing.



Fig. C.4-2: Ventilating Screw

- Open the ventilating screw on the thermostat casing.

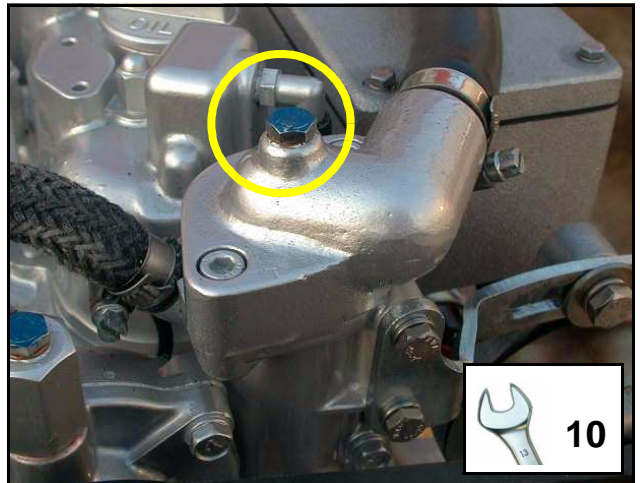

Fig. C.4-3: Ventilating Screw on the Thermostat Housing

- Pour cooling water into the cooling water filling necks.
- If the cooling water level no longer drops (the cooling water level in cold waters must cover the tin in the exhaust elbow), close the filler cover and the cooling water screws and then start the generator.
- Run the generator for approx. 60 Seconds, then switch off
- Refill cooling water via the compensation tank.

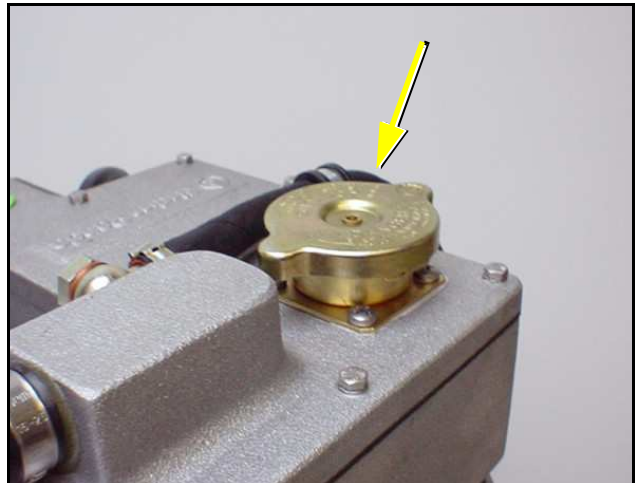

Fig. C.4-4: Colling Water Filler Cap

- The compensation tank is connected to the generator by two hoses.

The external compensation tank should be filled to a max 20% in a cold state. It is very important that a larger expansion area is maintained above the cooling water level.

- Repeat this procedure 1 - 5 times.

If there is no change to the state of the cooling water level, the generator is re-started for 5 minutes. Thereafter the de-aeration must be repeated two to three times.



The ventilation screw above the cooling water pump casing may not be opened under any circumstances, whilst the generator is running. Air will be sucked through the opening, if this should happen by mistake. Venting the whole system afterwards is necessary and very difficult.



Fig. C.4-5: Ventilation Screw above the Cooling Water Pump Casing

C.4.5 Exchange of the V-Belt for the Internal Cooling Water Pump

The relative high ambient temperature in the closed sound insulated capsule (about 85°C) can be a reason for a reduced lifespan of the v-belts. It is possible that the "softener" in the rubber compound lose their effect after a short operating time because the air in the sound insulated capsule can be relative warm and dry. The v-belt must be controlled at very short time intervals. It may be required to change the v-belt after several weeks because of unfavourable conditions. Therefore, control should be carried out after an interval of 100 operating hours. The v-belt is a wearing part. There should be enough spare v-belts on board. We recommend that you have the respective manual within reach.

1. Loosen the screw on the deflection pulley bracket

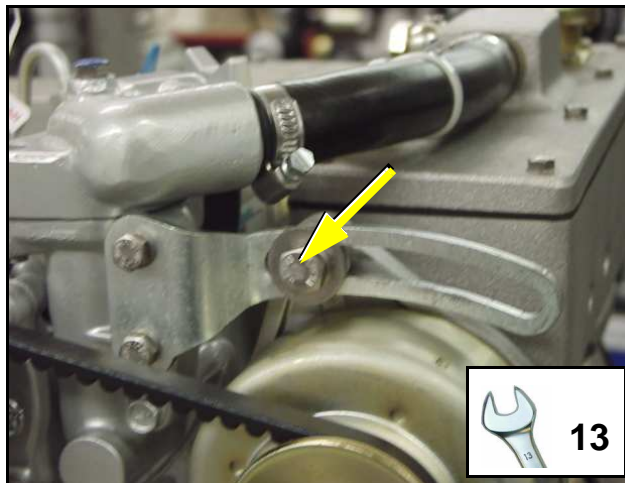

Fig. C.4.5-1: Screw on the deflection pulley bracket

2. Loosen the screw beneath the alternator

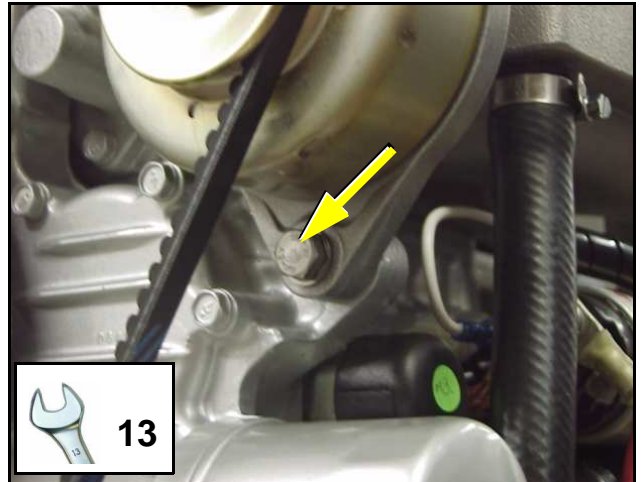

Fig. C.4.5-2: Screw beneath the Alternator

3. Press the alternator in the direction of the thermostat casing
4. Exchange Belt Pulleys

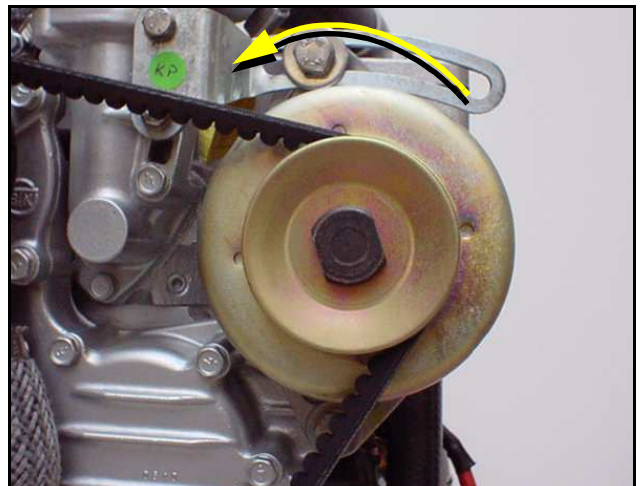

Fig. C.4.5-3: DC Alternator

5. Re-tighten Belt Pulleys
The belt pulleys should only be tightened to the extent that it can be pushed to the length of a thumb (approx. 10 mm).
6. Re-tighten the screws above and below the alternator

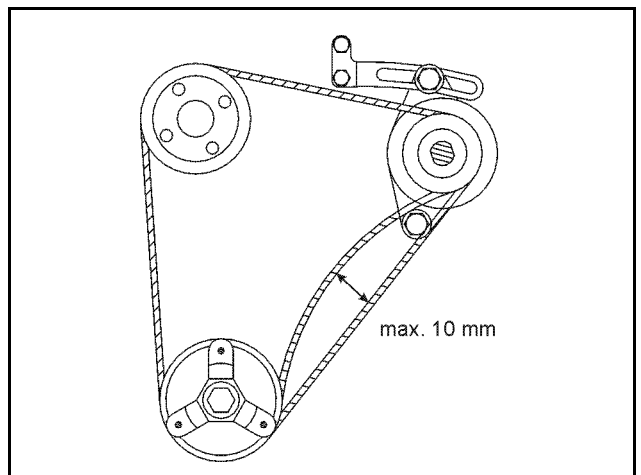

Fig. C.4.5-4: Drawing belt pulley

C.5 The Seawater Circuit

C.5.1 Clean Seawater Filter

Residue should be regularly removed from the seawater filter. The seacock must, in each case, be closed first. It often suffices to merely hit the filter punnet.

If water should seep through the cover of the seawater filter, this may never be sealed with adhesive or sealant. The cause for the leakage must be sought. The sealing ring between caps and filter holders must be exchanged in the simplest cases.



Fig. C.5.1-1: Seawater Filter

C.6 Reason for Frequent Impeller Wear

1. Unreasonable operating conditions

The Cooling water pump Impeller must be regarded as a wearing part. The life expectancy of an impeller can vary greatly and depends exclusively upon the operating conditions. The PANDA Generator cooling pumps are so designed that the speed of the pump in comparison to other generators is relatively low. This has a positive effect on the life expectancy of the pump.

2. Longer Suction Distance of Cooling Water

If the cooling water suction distance is long, or is blocked, this has a negative effect on the impeller, so that an under-pressure occurs in the cooling water suction area. This can reduce the efficiency of the impeller and place strain on the blades. This can greatly reduce the life expectancy.

3. Operating in contaminated waters

The impeller is placed under great strain in waters with high contamination. The use of the impeller in coral waters is also critical. There are known cases, whereby the impeller was so fatigued after 100 hours use, that the lip seals were grinded away by the shaft. In these cases sharp crystal parts from the coral press into the rubber seals and act as a grinding material on the stainless steel shaft of the impeller pump.

4. Generator mounted above the water level

It is especially disadvantageous for the impeller pump, if the generator is mounted above the water level. This means that a few seconds will pass before the impeller can suck in cooling water. This short dry running period damages the impeller. The increased wear can also lead to a breakdown. (See special instruction: "Effect on the impeller pump, if the generator is mounted above the water line").

C.6.1 Exchanging the Impeller

1. Close the seawater valve.

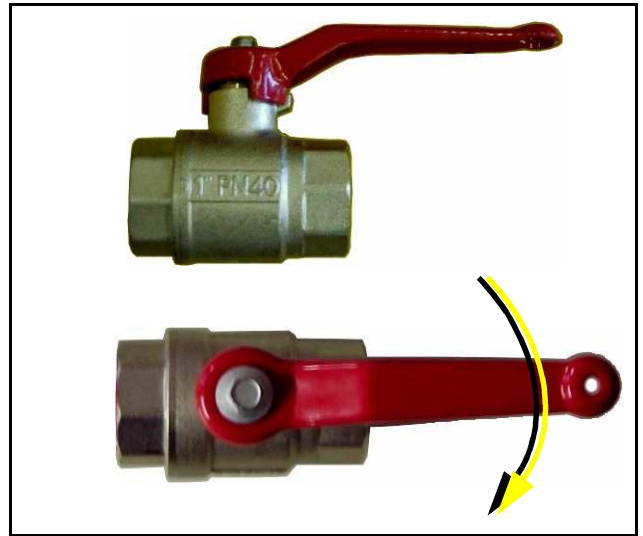

Fig. C.6.1-1: Seawater valve

The seawater pump is located on the front side of the genset.

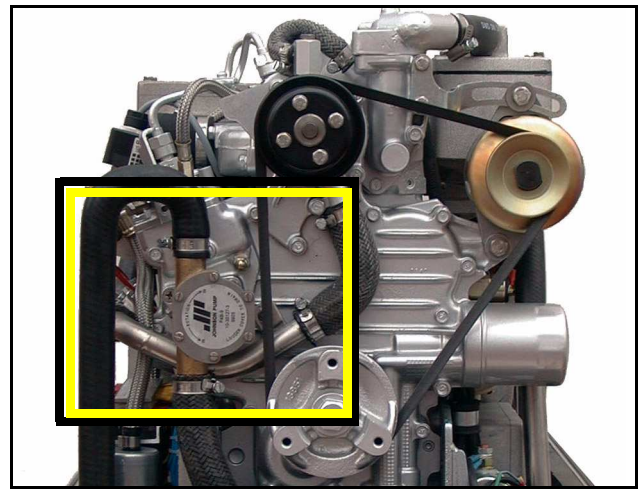

Fig. C.6.1-2: Seawater pump

Remove the cover of the seawater pump by loosening the 4 wing screws from the housing.

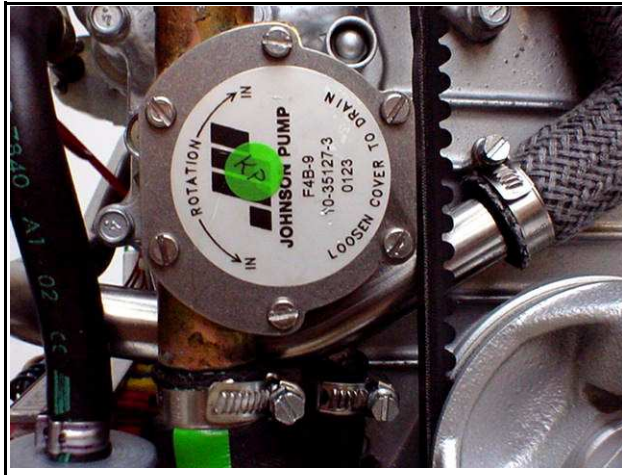

Fig. C.6.1-3: Cover Seawater Pump

2. Remove the impeller from the shaft by means of multi grip pliers..
3. Mark the impeller, to make sure that it is in the correct position when re-installation is carried out.

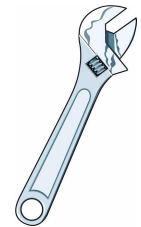
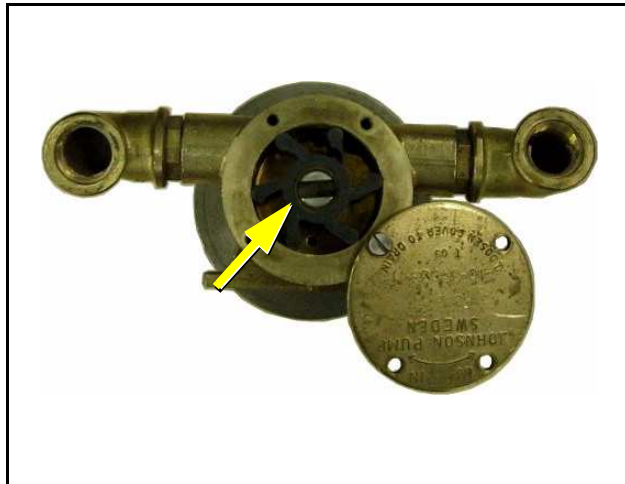

Fig. C.6.1-4: Impeller

4. Check the impeller for damage and replace it if necessary.
5. The impeller should have been lubricated with glycerine or with a non-mineral oil based lubricated e.g. silicone spray, before re-insertion into the housing. Attention: This is very important, because the impeller can quickly be damaged.



Fig. C.6.1-5: Impeller



6. Attach the impeller to the pump shaft (if the old impeller is re-used, initially check the marking).
7. Fastening the cover and use a new seal.

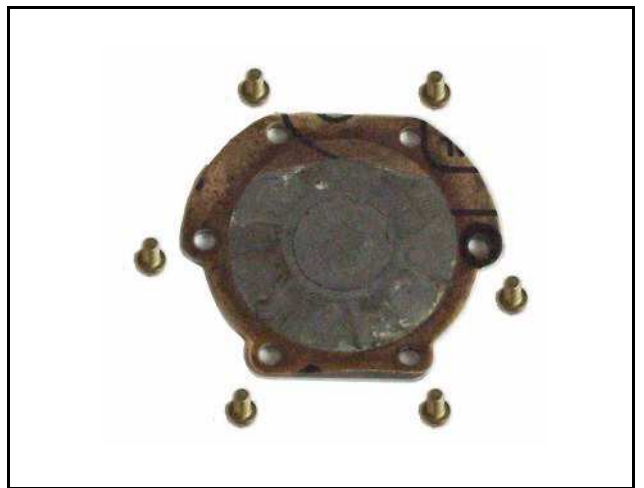
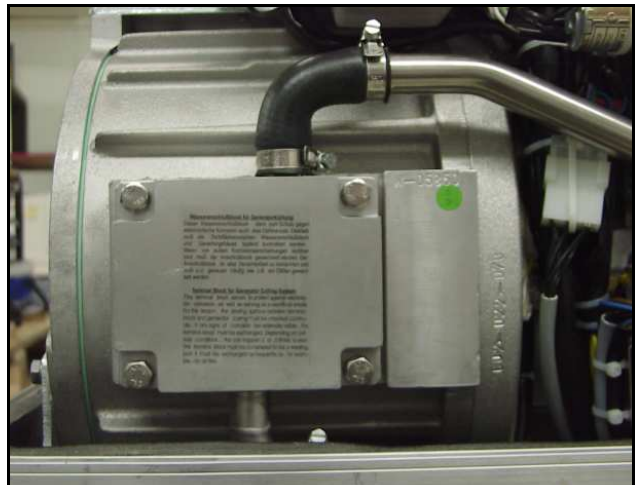

Fig. C.6.1-6: Cover Pump Shaft

C.7 Coolant Connection Block at the Generator Capsule

Control of the coolant connection block

The coolant terminal block at the side of the generator housing must be thoroughly checked in the case of all seawater-cooled generators. This coolant terminal block is manufactured from a special aluminium alloy and also serves as a sacrificial anode. If the aluminium alloy of the generator is damaged by the Direct Current, it initially affects the coolant inlet block. If visible corrosion is identifiable from the outside of the coolant terminal block, then the block must be replaced at regular intervals (at least once per year).



In this case the coolant terminal block is a wearing part. It should always be available in all cases as a spare part on board.

Fig. C.7-1: Coolant Connection Block



Replacement of the Coolant Connection Block

A "special" sealant is used for the coolant connection block. The fixing bolts are not intended to fix the coolant terminal block firmly to the surface area. These screws serve only to keep coolant terminal block firmly secured until the sealant has hardened. The fixing bolts should only be tightened by hand.

ATTENTION! On the side, the fixing bolts must be applied with an electrically neutral fat (e.g. anti seize). If the fixing bolts (high-grade steel) are screwed into the aluminium threads without the grease being used, then there is a danger of corrosion, and it is possible that the thread wears out when loosening the screws.



C.8 Conservation of the Generator (long operation interruption)

C.8.1 Measures for preparation of winter storage

1. Rinse seawater circuit with an anti-freeze solution, if this contains a corrosion protection solution. The seawater intake must be stopped at the seacock. The anti-freeze protection mixture is to be sucked up from a container by means of a hose connection. The cooling water mixed with the exhaust gases should be fed back to the suction container. The circuit must be kept upright some minutes to ensure the anti-freeze protection mixture reaches all parts of the cooling system.
2. The anti-freeze mixture concentration in the internal cooling circuit must be checked with a suitable measuring instrument. The concentration must be adequate for the lowest expected temperatures.
3. Clean seawater filter and check seal.
4. Check seacock for practicability. And spray with a corrosion protection oil from the inside or lubricate with acid-resistant grease.
5. Check all hoses and hose connectors for good condition. The rubber hoses are very sensitive to environmental influences. They can deteriorate quickly in environments with dry air, light oil, fuel fumes and increased temperatures. The hoses must be checked regularly for elasticity. The hoses must be renewed once in the year in particular operating situations.
6. Doubly check the hose connections at all seawater valves, and if possible protect them with double hose clamps.
7. Dismount the cooling water pump impeller and check for wear. The impeller may not remain in the pump. It must be greased with Vaseline and be kept in a dark place. It can be re-integrated again into the pump, during the spring, if it is in good condition. The impeller is a wearing part, and it is recommended that it is always renewed in the spring, depending upon the number of hours the generator has been running.
8. Control of the vent valve at the seawater inlet. A vent valve is always necessary, if the generator is installed below the waterline. The vent valve must also be regularly checked during the season. The vent valve should always be disassembled, checked and greased during winter storage. Hardened or dirty parts are to be replaced.
9. Check water lock: If the generator were rinsed with an anti-freeze mixture, the anti-freeze mixture can escape from the water lock. If the generator were rinsed with fresh water, the water in the water lock must be drained. Otherwise there is a danger of the collector being destroyed by ice through expansion.
10. Check the exhaust/water separator for leakage and whether the hose connections at the lower surface of the separation unit are in normal condition. (in the case of extremely sulphurous fuels, it is possible that high-grade steel tube ends are attacked.)
11. Check all construction units of the generator inside the sound cover for leakages. If there are traces of humidity in the sound cover, the cover must be dried. Furthermore, the cause for damp must be searched and eliminated.

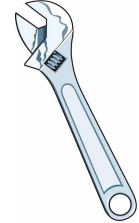



C.8.1 Measures for preparation of winter storage

12. During the winter storage the upper section of the sound insulated capsule must be taken off, in order to avoid condensed moisture formation, if traces of humidity remain in the sound insulation capsule inside casing by leakages in the seawater circuit.
13. The generator housing and the housing of the engine should be sprayed with a corrosion protection oil before the winter storage. This procedure is recommended also in the season. This procedure can avoid that arising and humidity marks on the surface of the aluminum construction units be noticed too late.
14. Disconnect the starter battery (positive and negative pole).
15. Lubricate the spindle for the number of revolutions adjustment device with a special lubricant (Antiseize grease).
16. Check cooling water connection block at the generator housing on traces of corrosion and if necessary renew. (Only such traces are to be considered, which refer to clear "blossoming" of the material. If the surface is only grey coated, this is only an indication for the fact that aluminum came into contact with condensed moisture.)
17. Use of a air dehumidifier. The best way to protect a yacht in the winter storage against damage by humidity is, to place a air dehumidifier inside the ship and lock all hatches. The devices have a hygrometer, which switches the device off, if the humidity is under the adjusted value. There is no better method, in order to protect pads, cable, electronics, wood, engines etc. optimally against any rotting by humidity.

C.8.2 Initiation during Spring

- Before starting, turn the engine once with the hand, in order to eliminate the beginnings of existing corrosion to the bushes. If necessarily carry out normal engine inspection.
- Change engine oil and engine oil filters.
- Reintegrate the impeller of the cooling water pump and check pump for leakage.
- Charge starter battery of the generator, connect cables and check battery voltage.
- Start generator and check the basic adjustments of the generator such as voltage, speed regulation etc...
- Check all switching off devices for function by operational procedures.



D. Installation Instructions

D.1 Placement

Since Panda generators have extremely compact dimensions, they can be installed in tight locations. Attempts are sometimes made to install them in almost inaccessible places. Please consider that even almost maintenance-free machinery must still remain accessible at least at the front (drive belt, water pump) and the service-side (actuator, dipstick). Please also note that in spite of the automatic oil-pressure sensor it is still essential that the oil level has to be checked regularly.

The generator should not be placed in the proximity of light walls or floors, which can have resonance vibrations because of airborne sounds. If this should be unavoidable, then it is recommended that this surface is lined with 1 mm lead foil, which will change the mass and the vibration behaviour.

You should avoid fixing the generator on a slippery surface with little mass (i.e.). This acts as an amplifier of airborne sounds in the most unreasonable case. An improvement can be achieved by reinforcing these surfaces with ribs. In addition, the breakthroughs, which interrupt these surfaces, should be sawed off. The lining of the surrounding walls with a heavy layer (i.e. lead) and foam additionally improve the conditions.

The generator sucks its air from the surrounding engine room. Therefore it must be ensured that sufficient ventilation openings are present, so that the generator cannot overheat.

High temperature of the intake air decline the power of the generator and increases the coolant temperature. Air temperatures of more than 40 °C reduce the power by 2 % per temperature rise of 5 °C. In order to keep these effects as small as possible, the temperature in the engine room should not be higher than 15 °C in relation to the outside temperature.

D.1.1 Advice for optimal sound insulation

The convenient base consists of a stable framework, on which the generator is fastened by means of shock-mounts.

Since the aggregate is "free" downward, the combustion air can be sucked in unhindered.

In addition are void the vibrations, which would arise with a closed soil.

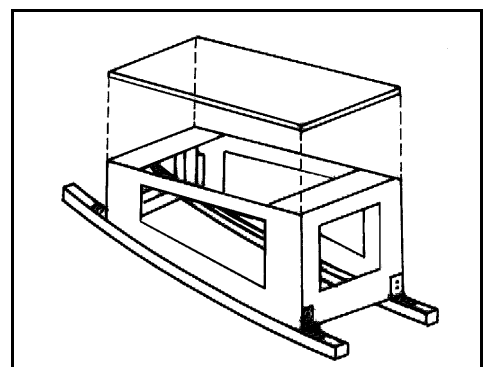

Fig. D.1.1-1: Generator Base

D.2 Generator Connections

Connect all electrical wires within the capsule tightly to the motor and the generator. This is also the case for fuel lines and cooling water lines.

The electrical connections **MUST** be carried out according to the respective valid regulations. This also concerns used cable materials. The cable supplied is meant for laying "protected" (i.e. in pipe) at a temperature up to a max. of. 70 °C (160 °F). The on-board circuit must also be fitted with all essential fuses.



ATTENTION! Before working (installation) on the System read the section „Safety Instructions“ in this Manual.

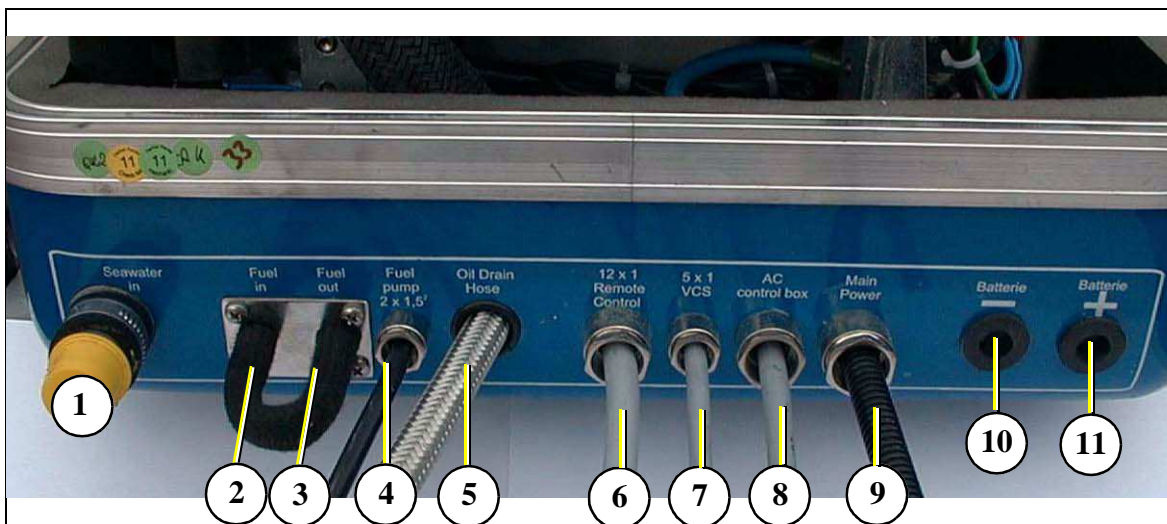

- | | |
|---|---|
| 1. raw water inlet | 7. VCS cable to AC-Control box |
| 2. Fuel supply (in) | 8. Generator output cable to AC-Control box |
| 3. Fuel return line (out) | 9. Generator AC-output cable |
| 4. Electrical cable for external fuel pump | 10. Generator Starter-battery negative (-) |
| 5. Motor oil drain hose | 11. Generator Starter-battery positive (+) |
| 6. Electrical cable to remote control panel | |

Fig. D.2-1: Generator Connections



01) external expansion tank

02) external vent valve

Fig. D.2-2: Generator Connections

D.3 Cooling System Installation - Raw Water

D.3.1 General Information

The genset should have its own raw water (coolant water) inlet and should not be connected to any other engine systems. Ensure that the following installation instructions are complied with:

For the avoidance of galvanic corrosion, refer to the chapter "Service instruction for marine generators (corrosion protection)".

D.3.2 Installation of the thru hull fitting in Yachts

It is good practice for yachts to use a thru hull fitting with an integrated strainer. The thru hull fitting (raw water intake) is often mounted against the sailing direction to induce more water intake for cooling.

For Panda generators, the thru hull inlet should NOT point in the sailing direction! When sailing at higher speeds more water will be forced into the inlet than the pump can handle and your generator will flood!

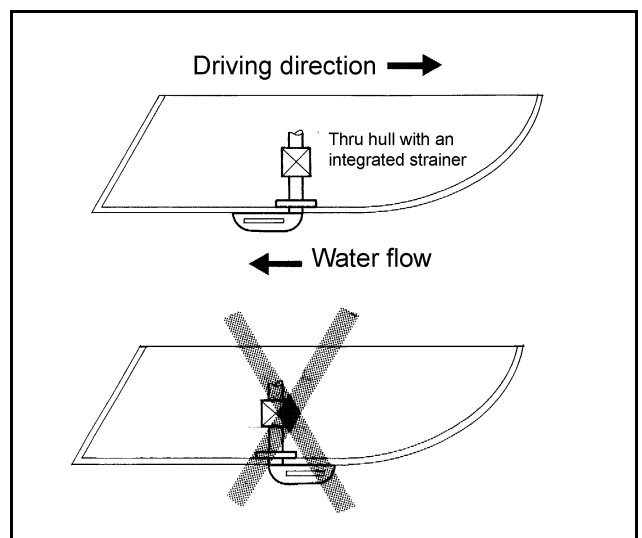

Fig. D.3.2-1: Position of the Thru Hull Fitting

D.3.3 Quality of the Raw Water Sucking In Line

In order to keep the suction resistance in the line at a minimum, the raw water intake system (i.e. sea cock, thru-hull fitting, inlet filter, etc.) must have an inner diameter of at least 1" (25 mm).

This applies also to installation components such as thru-hull fitting, sea cock, raw water filter etc.

The intake suction line should be kept as short as possible. Install the raw water inlet in close proximity to the genset.

After start-up the cooling water quantity must be measured (e.g. by catching at the exhaust). The flow rate, as well as the necessary cross section of the cooling water pipe see section E.3, "Technical Data Generator," on page 83

D.3.4 Generator Installation above Waterline

The Panda is equipped with a direct drive water intake pump mounted directly on the motor. Since the intake pump is an impeller pump there are wearing parts which are likely to require replacement after a period of time. Ensure that the genset is installed so that the intake pump can be easily accessed. If this is not possible, an external intake pump could be installed in an easily accessible location.

If the generator is installed above the waterline, it is possible that the impeller will wear out faster, because after starting, the pump runs dry for some seconds.

The raw water hose should form a loop as near as possible to the raw water inlet of the generator (see picture below). This ensures the pump only sucks in air for a short time. The impeller pump will be lubricated by raw water and the impeller life span will be increased.

By the installation of a check valve in the raw water inlet line, which is under the waterline, this problem can be restricted.

The impeller pump will remain intact longer, if an electrical booster pump is installed, and is strongly recommended in order to preserve the impeller pump.



NOTE:

Never change the impeller for many years, without exchanging the old pump. If the sealing ring is defective within the pump, raw water runs into the sound cover of the genset. A repair is then very expensive.

Replacement impeller and also a spare pump should always be on board. The old pump can be sent back to Fischer Panda.

1. Raw water filter
2. Water cock
3. Thru hull

Make certain that the raw water filter lies above the water level, otherwise with cleaning water can penetrate by the thru hull. An external pre-pump can relieve the impeller.

An external pre-pump can relieve the impeller.

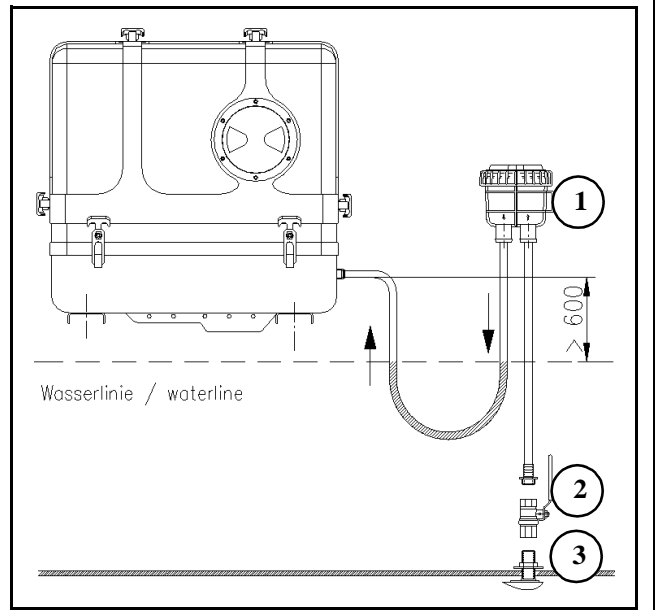

Fig. D.3.4-1: Einbau des Generators über der Wasserlinie

D.3.5 Generator Installation below Water-Line

If the generator cannot be attached at least 600 mm above the waterline, a vent valve must be installed at the raw water line.

Possible heeling must be taken into consideration if installed at the "mid-ship line"!

The water hose for the external vent valve is located at the back of the sound insulated cover. This hose is split in the middle and extended respectively at each end by an additional hose and a connecting nipple. Both hose ends must be led outside of the sound cover to one point, if possible 600 mm over the waterline in the mid-ship line. The valve is connected at the highest place to the two hose ends.



Note: The vent valve must be installed directly behind the water pump.

If the water pump ceases, the valve spring ensures that air can enter and therefore, a syphon effect is avoided.

The de-aeration valve must be regularly controlled. If the water pump stops, the valve spring ensures that air enters. It must be opened, cleaned and greased.

Fig. D.3.5-1: Vent Valve

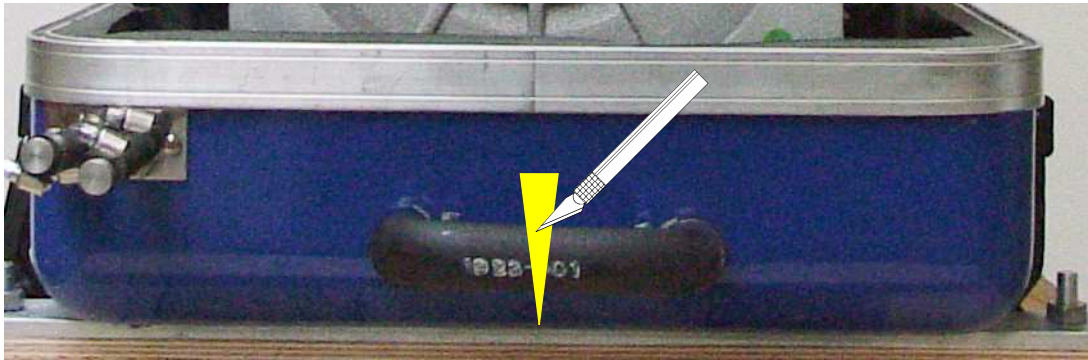

Cut the hose for the external vent valve....

Fig. D.1: Connection Vent Valve

...and bend it upwards.

Both hose ends must be led out outside of the sound cover to one point, if possible 600 mm over the waterline at the mid-ships line. The valve is connected at the highest place with the two hose ends.

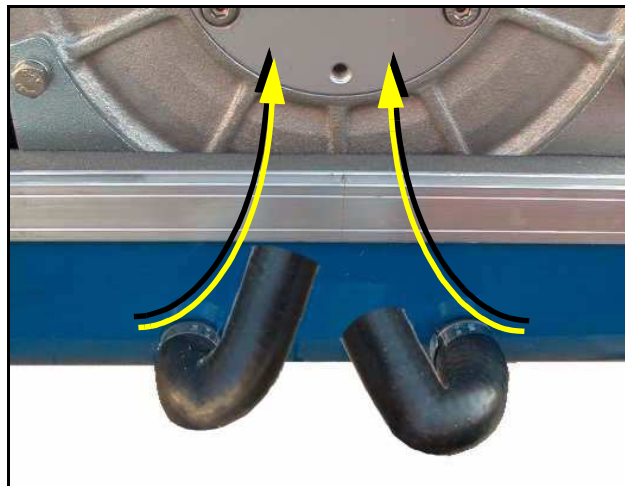

Fig. D.3.5-2: Connection Vent Valve

D.3.6 Generator Housing cooled by Raw Water

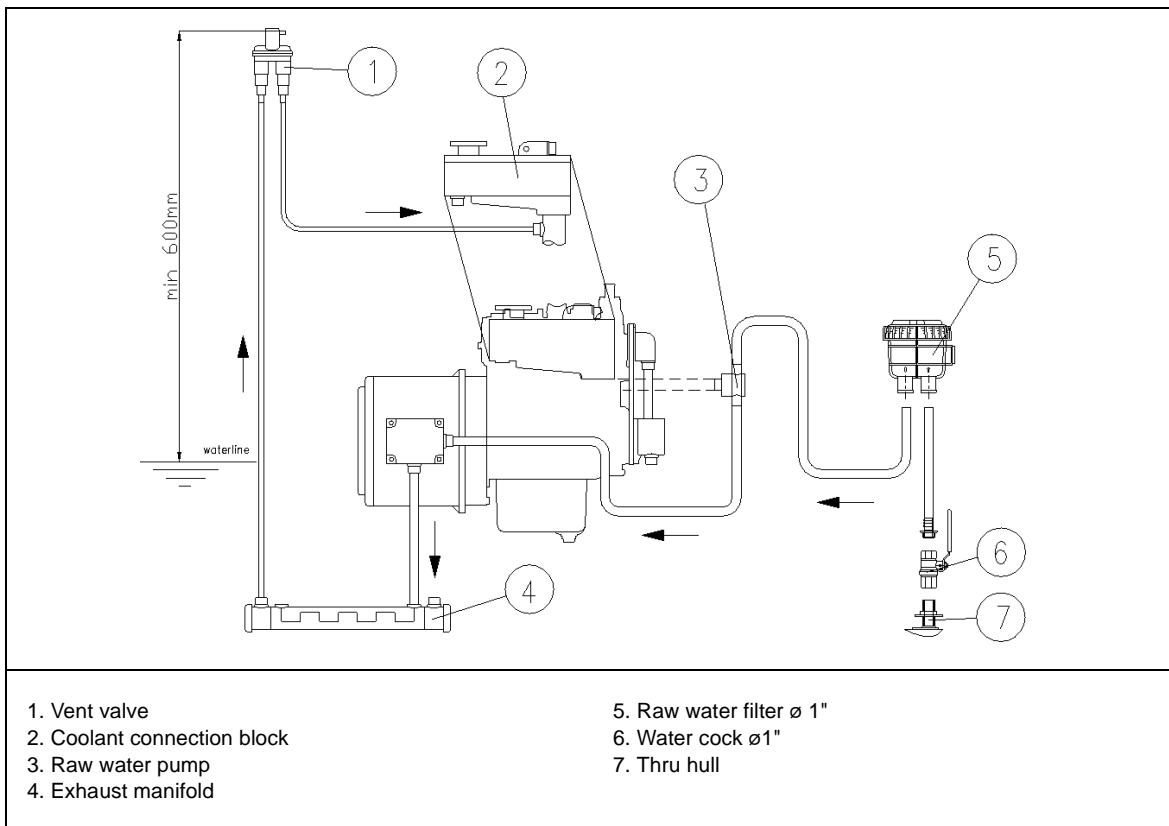

Fig. D.3.6-1: Installaton Scheme for Direct Cooling

D.3.7 Indirect Cooling of the Genset Housing (by the Heat Exchanger)

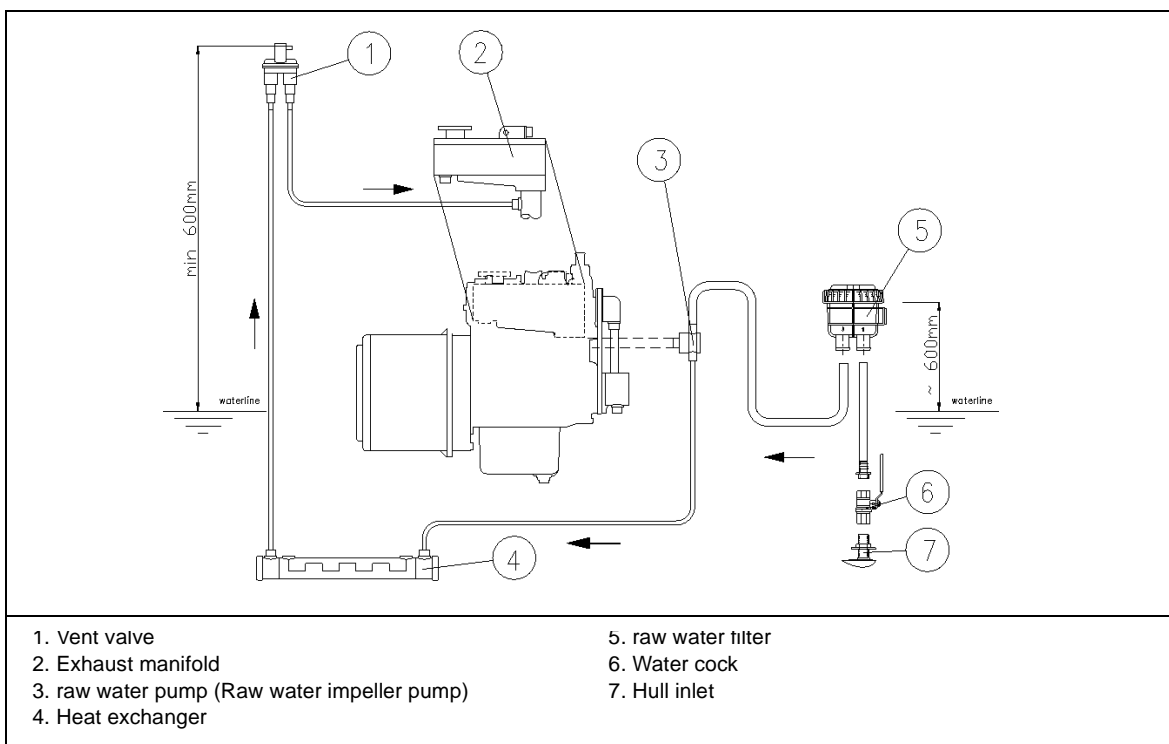

Fig. D.3.7-1: Installation Scheme Indirect Cooling of teh Genset Housing

D.4 The Freshwater Coolant Circuit

D.4.1 Position of the external cooling water expansion tank

Position of the external cooling water expansion tank

The Panda generator is normally supplied with an additional, external cooling water expansion tank. This tank must be installed in such a way that its lower edge is at least 500 mm more highly arranged than the upper edge of the sound cover.

If this 500 mm should be fallen below, i.e. the cooling water expansion tank is lower installed, very large problems can occur with filling and ventilating. Extend and displace the hose lines to the outside or possibly even up to the deck.

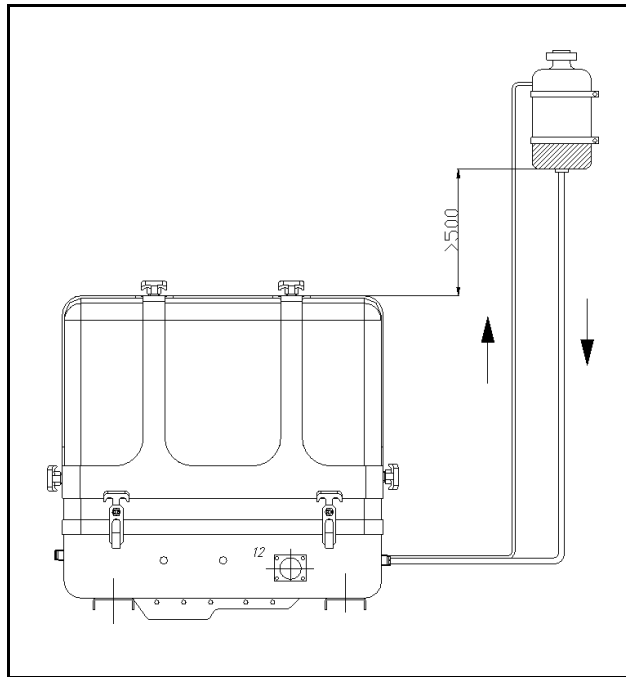

Fig. D.4.1-1: Position of the External Cooling Water Expansion Tank



ATTENTION! The external cooling water expansion tank may be filled only up to the lower edge of the lower tension tape (see note "max") in the maximum filling level in cold condition.

D.4.2 Ventilating at the first filling of the Internal Cooling Water Circuit

1. Fill up the external cooling water expansion tank with coolant.

ATTENTION: maximum fill level = „max.“- mark.

The cover of the external expansion tank temporarily must be opened (all other closures are now closed!).



Fig. D.4.2-1: Expansion tank

2. Open vent screw on the pipe socket of the internal cooling water pump. Close the vent screw when air free water comes out

Check the water level in the expansion tank during the venting. Fill up if necessary.

Never open the vent screw while the generator is running

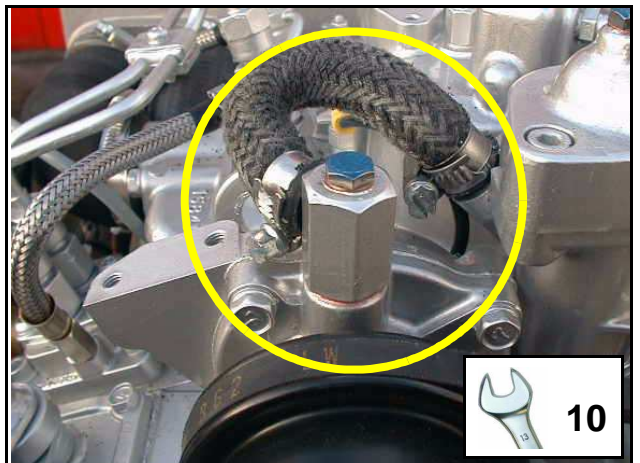

Fig. D.4.2-2: Venting screw

3. Open vent screw on the thermostat housing. Close the vent screw when air free water comes out

Check the water level in the expansion tank during the venting. Fill up if necessary.

Never open the vent screw while the generator is running



Fig. D.4.2-3: venting screw

4. Start the Generator

After filling the generator it must be started. During this first phase of start-up, the generator may not be loaded. Switch the generator off after about 10 sek. of operation!

6. Repeat the steps 1-4 till no air comes out of the vent screw at thermostat housing.

Close the vent screws.

Fill up the expansion tank.

Close the expansion tank.

7. Re-ventilating process 10 Operating hours after the first start-up (and if necessary)

Also after the first implementing a small amount of air can be reside in the cooling circuit. To ensure an immaculate und actual operating of the cooling system the ventilating process must be repeated casual in the next few days (weeks, if necessary). Small amount of air will still exit out of the ventilating openings, especially if the generator stood still for a long time.



ATTENTION! During the ventilating process repeated checks must be made to check the cooling water is indeed circulating. If there are air bubbles in the internal cooling water pump, it could be that the cooling water is not circulating. The generator will heat up very quickly and switch off, because of overheating.

Anti-freeze

In the interest of safety, the freezing point of the closed circuit coolant should be checked on a regular basis. Be sure that the coolant/antifreeze mixture is good for at least -15°C (5 °F) and if it is possible that your genset experiences lower temperatures, for example during storage or transportation, then the entire cooling system should be drained and purged

D.4.3 Pressure Test for Controlling the Cooling Water Circuit

Check if a temperature difference exists between cooling water in-flow and cooling water return flow by use of the hand.

Feel the cooling water in-flow line at the internal cooling water pump.

Feel the cooling water return pipe either at the outlet of the water-cooled exhaust elbow union or at the side, where this pipe exits at the heat exchanger.

The temperature difference between in-flow and return should be approx 10 degrees.

D.4.4 Scheme for Freshwater Circuit at Two Circuit Cooling System

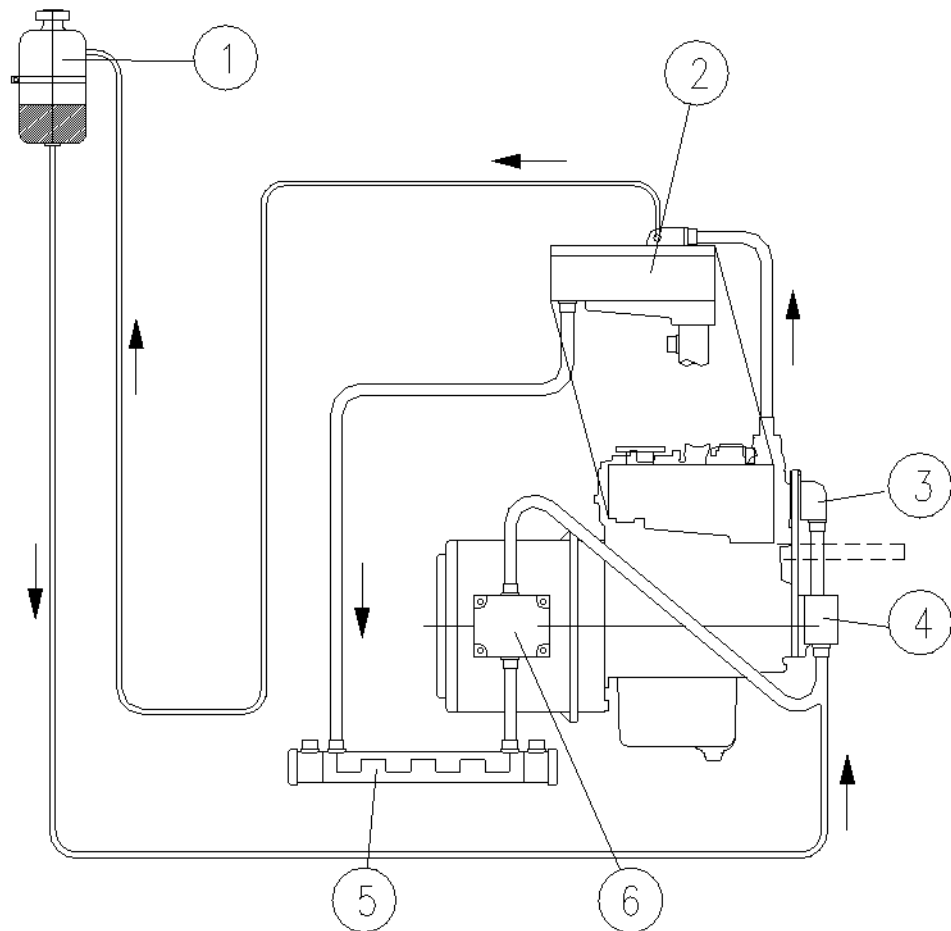

- | | |
|-----------------------|-----------------------------------|
| 1. Expansion Tank | 4. Freshwater pump |
| 2. Exhaust Manifold | 5. Heat Exchanger |
| 3. Thermostat Housing | 6. Cooling Water Connection Block |

Fig. D-1: Scheme for Freshwater Circuit at Two Circuit Cooling System

D.4.5 Pressure Test for Controlling the Cooling Water Circuit

Check if a temperature difference exists between cooling water in-flow and cooling water return flow by use of the hand.

Feel the cooling water in-flow line at the internal cooling water pump.

Feel the cooling water return pipe either at the outlet of the water-cooled exhaust elbow union or at the side, where this pipe exits at the heat exchanger.

The temperature difference between in-flow and return should be approx 10 degrees.

D.4.6 Scheme for Freshwater Circuit at Two Circuit Cooling System

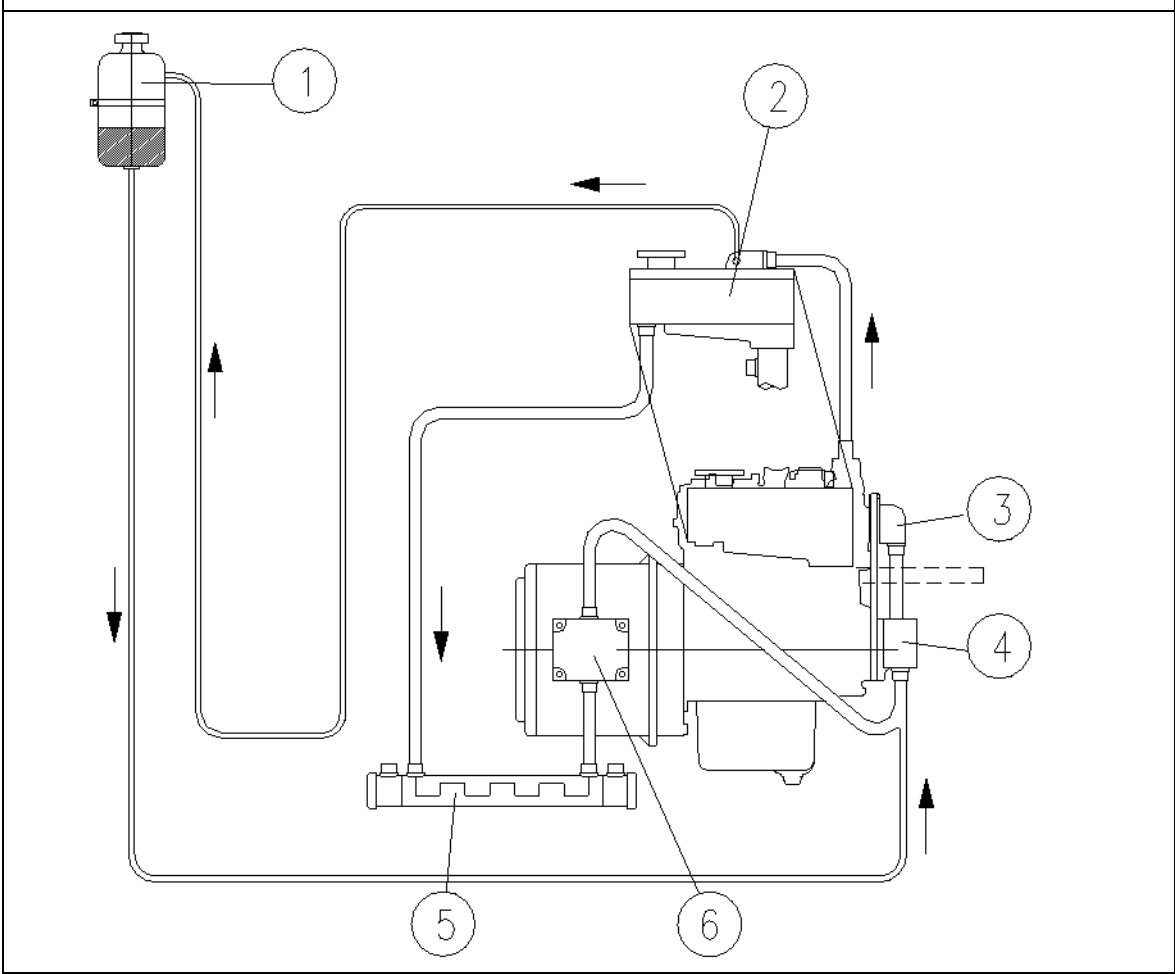

- | | |
|---|--|
| <ul style="list-style-type: none"> 1. Expansion Tank 2. Exhaust Manifold 3. Thermostat Housing | <ul style="list-style-type: none"> 4. Freshwater pump 5. Heat Exchanger 6. Cooling Water Connection Block |
|---|--|

Fig. D-2: Scheme for Freshwater Circuit at Two Circuit Cooling System

D.5 Water Cooled Exhaust System

By injecting the outlet raw water into the exhaust manifold, the exhaust gases are cooled and the noise emissions from the exhaust system are reduced.

D.5.1 Installation of the Standard Exhaust System

The generator exhaust system must remain completely independent and separate from the exhaust system of any other unit(s) on board. The exhaust hose has an inner diameter of 30 mm. The water lock must be installed at the lowest point of the exhaust system. An optional noise insulated water lock can also be installed. The exhaust hose descends from the capsule to the water lock. Then the hose rises via the "goose neck" to the silencer (see drawing). The goose neck must be vertical and sit preferably along the ship's keel centre line. The exhaust system must be installed so that the back pressure inside the exhaust does not exceed 0.4 bar (6 psi) and total length does not exceed 6 m (20 ft.).

Exhaust diameter see section E.3, "Technical Data Generator," on page 83.

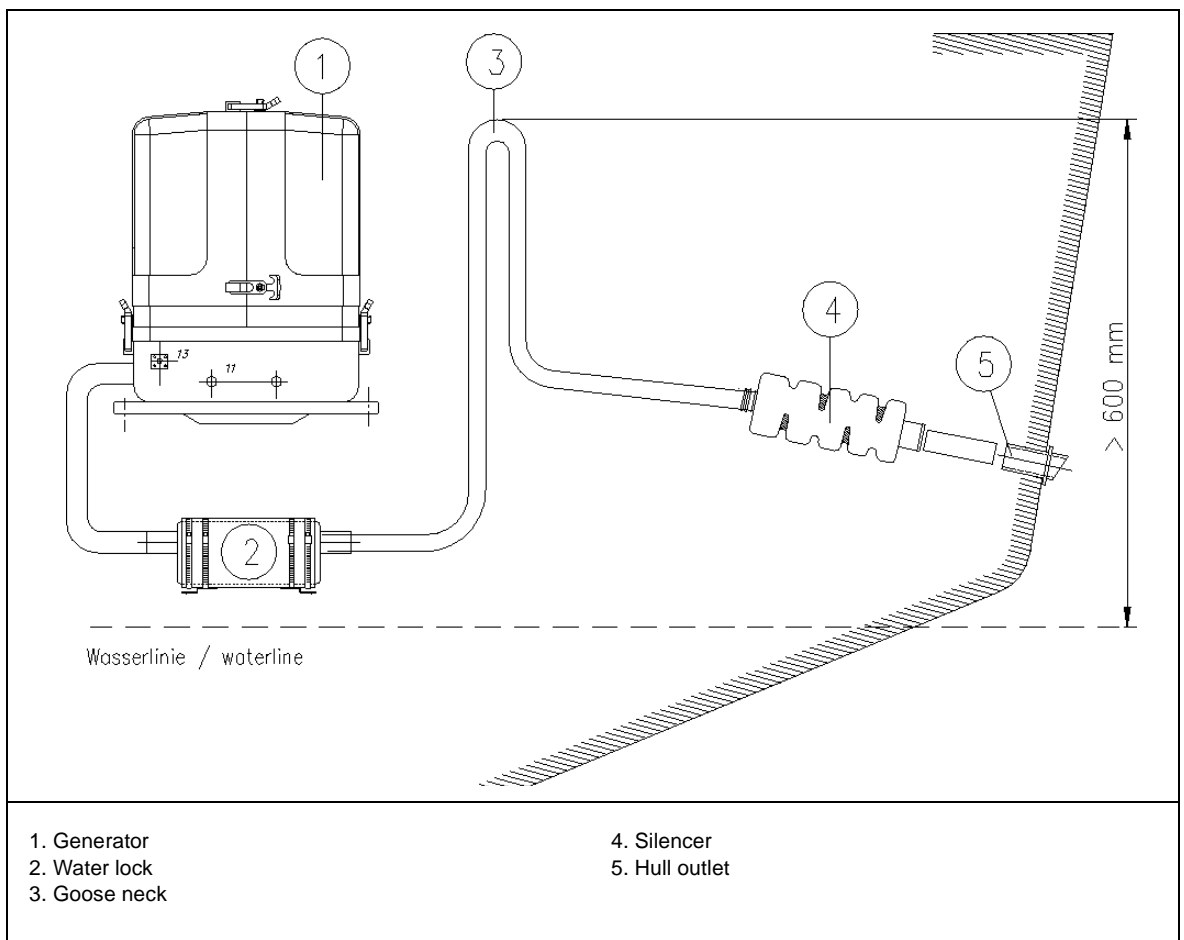

Fig. D.2: Installation Scheme Standard Exhaust System

D.5.2 Exhaust / Water separator

In order to reduce the noise level of the generator unit to a minimum, an optional exhaust outlet muffler can be mounted next to the thru-hull fitting. Additionally there is a component at Fischer Panda, which acts as both an "exhaust goose neck", and water separator. With this "exhaust/water separator" the cooling water is derived over a separate pipe. The exhaust noises emanating from the exterior of the yacht are strongly decreased. Particularly the "water splash".

The water flow on the exhaust/water separator unit has an inner diameter (ID) of 30 mm. If the path from the water separator to the raw water outlet is very short, the hose can be further reduced to 1" (25mm) ID.

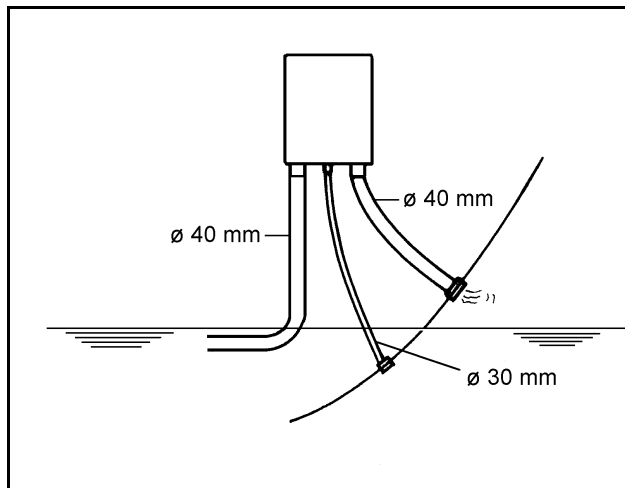

Fig. D.5.2-1: Water Flow Exhaust Water Separator

1. Raw water outlet \varnothing 30mm
2. Hose connector \varnothing 30mm
3. Reducer 30/20mm (if required)
4. Hose
5. Hose connector
6. Sea cock
7. Hull outlet
8. Hose Clips

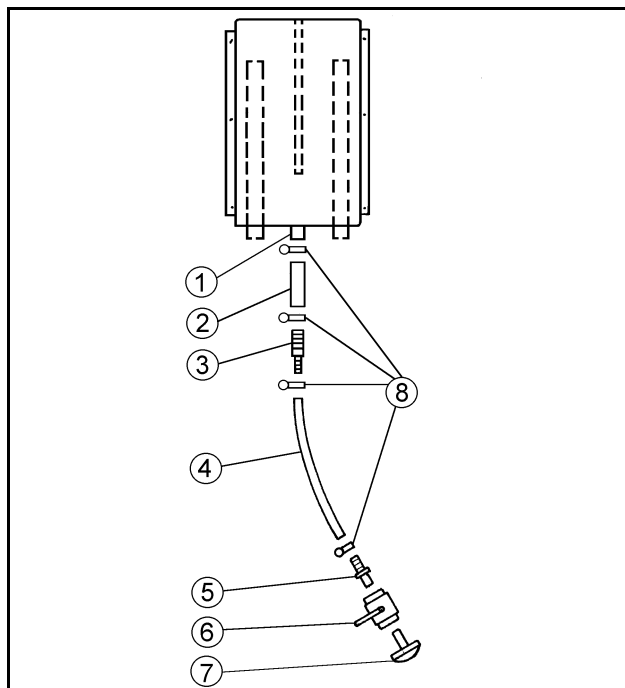
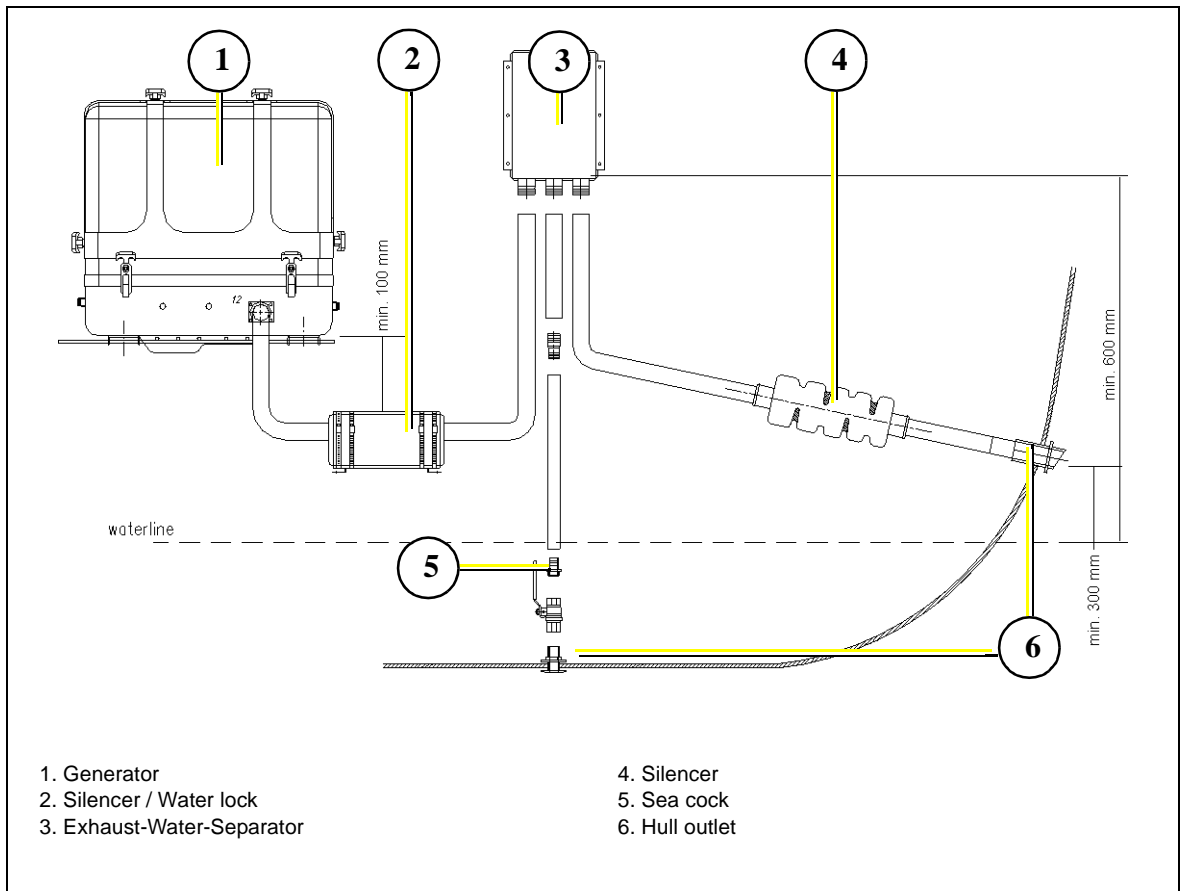

Fig. D.5.2-2: Exhaust Water Separator

D.5.3 Installation Exhaust-Water-Separator

If the exhaust/water separator was sufficiently highly installed, a goose neck is no longer necessary. The exhaust/water separator fulfils the same function. If the "Super silent" exhaust system were installed correctly, the generator will not disturb your boat neighbour. The exhaust noise should be nearly inaudible. The best result is reached, if the hose line, which derive the cooling water, is relocate on a short way "falling" directly to the outlet and this outlet is under the waterline.



If the thru-hull exhaust outlet has to be mounted far from the generator, an exhaust-water separator must definitely be installed. The raw water from the separator must then run along the shortest possible path to the thru-hull outlet. For such long exhaust routes, the exhaust hose diameter should also be increased from NW40mm to NW50mm in order to reduce the back-pressure. The exhaust may have a length of over 10m (32 ft.) if the exhaust hose diameter is increased to 50mm. An additional outlet exhaust muffler close to the hull outlet will help further to reduce noise emissions.

The generator will not disturb your boat neighbours, if the "Super silent Exhaust System" has been correctly installed. The exhaust noise should be almost inaudible.

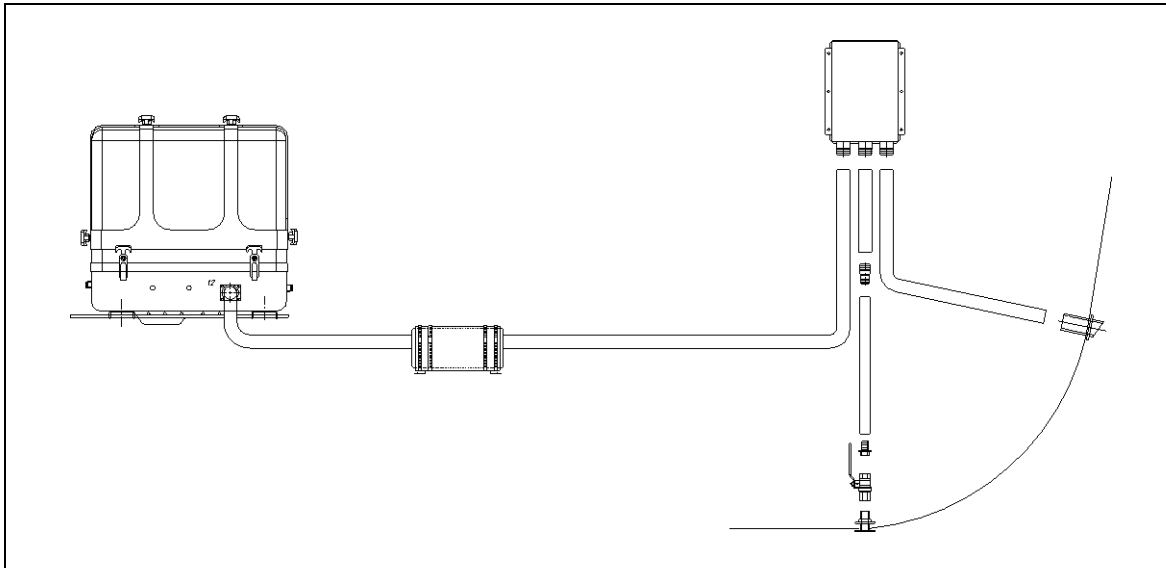

Example of an unfavourable installation:

- Water lock not far enough below the highest level of the generator
- Distance water lock to exhaust/water separator too large

Fig. D.5.3-1: Example for an Unfavourable Installation

D.6 Installation of the Fuel System

D.6.1 General References

Inside the generator capsule itself, there is the fuel filter installed (exception: Panda 4200 and 4500). Additional fuel filters (with water separator) must be mounted outside the capsule in easily accessible places in the fuel lines between the tank intake fuel pump and the diesel motor's fuel pump.

Generally forward and return fuel flow pipes must be mounted to the diesel tanks. Do not connect the generator fuel supply lines with any other fuel lines of other diesel systems.

- The following items need to be installed:
- Fuel supply pump (12 V - DC)
- Pre-filter with water separator (not part of the delivery)
- Fine particle fuel filter
- Return fuel line to fuel tank (unpressurized)

The fuel supply pump should be mounted as close to the fuel tank as possible. The electric cable for the fuel pump is already installed on the generator (length 5 m).

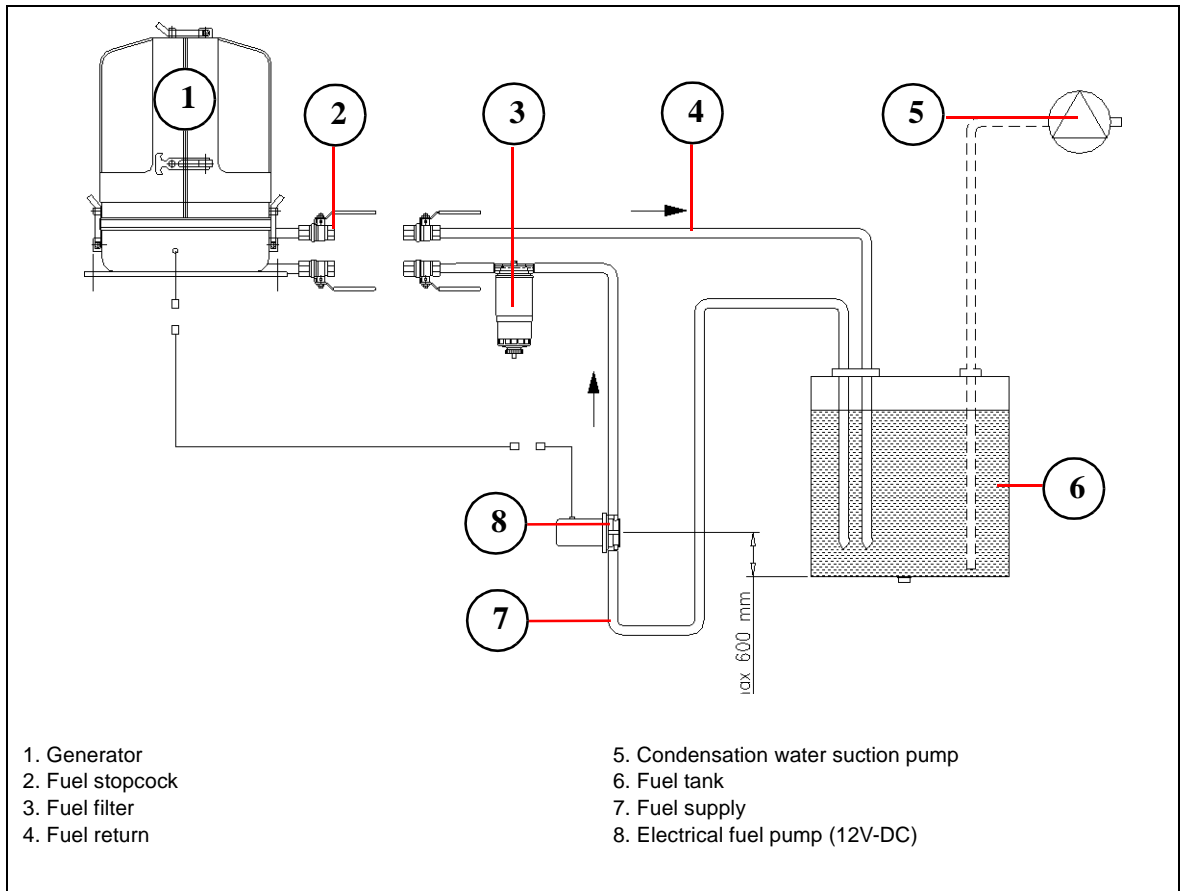

Fig. D.6.1-1: Installation Scheme Fuel System

D.6.2 The Electrical Fuel Pump

Electrical Fuel Pump

With the Panda generator is usually supplied an external, electrical fuel pump (12 V DC). The fuel pump must be installed close at the fuel tank. The electrical connections are pre-loaded at the generator with the lead planned.



Fig. D.6.2-1: Electrical Fuel Pump

- Suction height of the pump: max. 1,2 m at 02, bar
- Diameter of fuel lines: section E.3, "Technical Data Generator," on page 83.

D.6.3 Connection of the Fuel Lines at the Tank

Lead the return fuel pipe connected to the day tank to the floor

The return pipe connected to the tank must be dropped to the same depth as the suction pipe, if the generator is mounted higher than the tank, in order to prevent fuel running back into the tank after the motor has been switched off, which can lead to enormous problems, if the generator is switched off for a long period.

Non-return Valve in the Suction Pipe

A non-return valve must be fitted to the suction pipe, which prevents the fuel flowing back after the generator has been switched off, if it is not possible to use the return flow pipe as a submerge pipe placed in the tank. The instructions "Bleeding Air from the Fuel System" must be read after initial operation or after it has stood still for a long period, in order to preserve the starter battery.



ATTENTION! Non-return valve for the Fuel Return Pipe

If the fuel tank should be installed over the level of the generator (e.g. daily tank), then a non-return valve must be installed into the fuel return pipe to guarantee that through the return pipe no fuel is led into the injection pump.

D.6.4 Position of the Pre-Filter with Water Separator

Additionally to the standard fine filter a pre-filter with water separator must be installed outside of the sound insulation capsule in the fuel system line (not included in the delivery).



Fig. D.6.4-1: Pre-Filter with Water Separator

D.6.5 Ventilating Air from the Fuel System

Normally, the fuel system is designed to vent air itself i.e. as soon as the electric starter motor starts; the fuel pump starts working and the fuel system will be air-vent automatically after some time. It is, nevertheless essential, to vent the system as follows prior to the first operation (as all hoses are empty):

1. Switch main power switch on control panel "ON".
2. Push failure bypass switch and hold tight.

The electric fuel pump has to be run audibly. By moving the failure bypass switch you can hear the solenoid valve of the generator starting and stopping (when the sound insulation cover is taken off).

3. After the fuel pump has been running 3 to 4 minutes, because the failure bypass switch has been pressed down, the bleeding screw of the solenoid valve has to be unscrewed. The switch has to be continuously depressed, when opening the screw. A piece of cloth or absorbent paper should be put under the connection to avoid fuel entering the sound insulation cover.
4. The air vent screw can be screwed in again, as soon as fuel runs out without bubbles. Then release the depressing the failure bypass switch.

5. Starting the generator

Now the generator can be started by pushing the "START"-button. The generator should start after a short while. One of the pipe union nuts of an injection hose has to be unscrewed, should the unit not start; then try to restart the generator. After the generator has started, the pipe union nut has to be tightened again.

Main power switch "OFF"

Vent Screw at the fuel stop solenoid valve

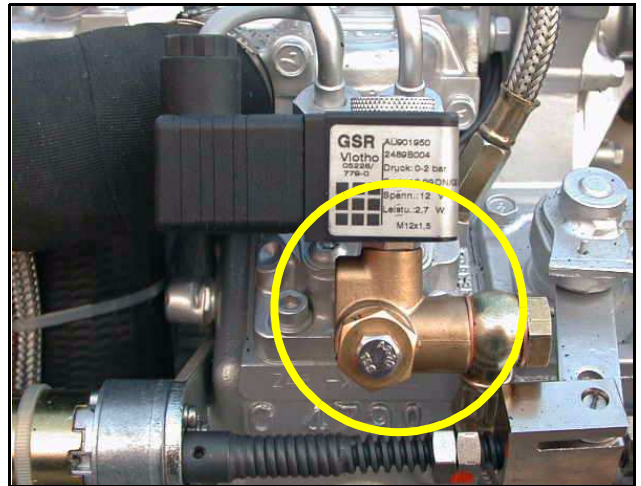

Fig. D.6.5-1: Vent Screw at the Fuel Stop Solenoid Valve

D.7 Generator 12 V DC System Installation

The Panda generators from 8.000 NE upwards have their own dynamo to charge a 12 V starter battery.

It is recommended to install an additional starter battery for the generator.

The generator is then independent from the remaining battery set. This enables you to start the genset at any time with its own starter battery even if the other batteries are discharged. A further advantage of a separate starter battery is that it isolates the generator's electric system from the rest of the boat's DC system, i.e. minus pole (-) is not connected electrically to Earth/Ground.

The generator is then Earth/Ground free.

D.7.1 Connection of the 12 V Starter Battery

The positive (+) battery cable is connected directly to the solenoid switch of the starter.



Fig. D.7.1-1: Positive Battery Cable

The negative (-) battery cable is connected to the engine foot.

Note! The battery negative pole may not be connected with the boat ground or with the protective grounding of the 120 V installation!



Fig. D.7.1-2: Negative Battery Cable

The Panda generators 8000 to 30 are equipped with various DC-relays, which can be found under the terminal strip. The various relays have the following tasks (also see the DC circuit diagram)

1. Starter motor relay
2. Pre-glow relay (glow plugs)
3. Fuel pump relay

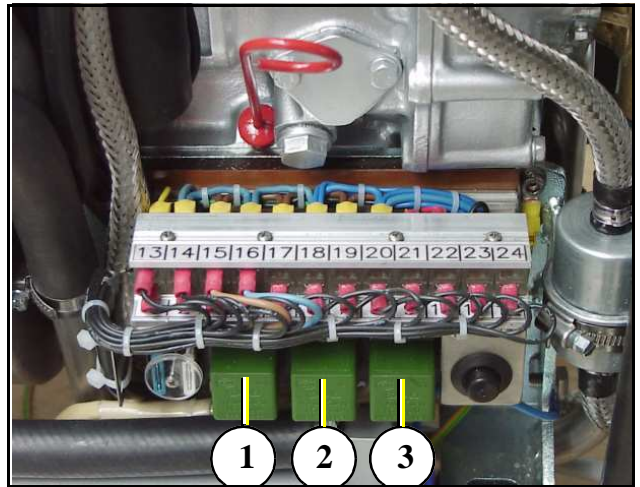

Fig. D.7.1-3: DC-Relay

All Panda generators are equipped with an independent 12 V DC starter motor. The connecting lines cross-section from the battery to the DC system should measure 25 mm².

1. Solenoid switch for starter motor
2. Starter motor

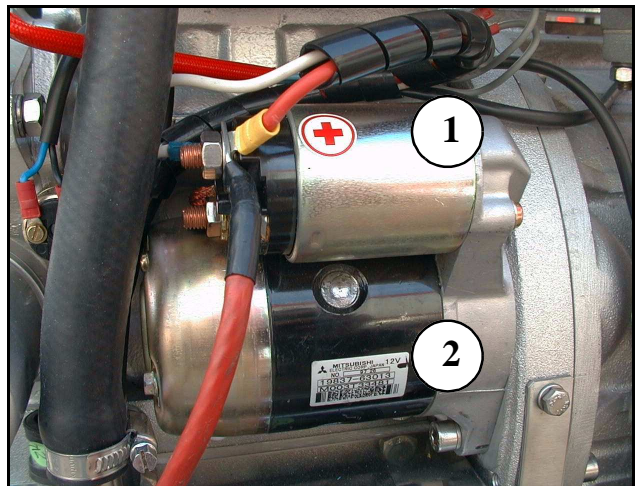

Fig. D.7.1-4: 12 V DC Starter Motor

D.7.2 Connection of the remote control panel - see separate control panel manual

D.8 Generator AC System Installation



ATTENTION! Before the electrical system is installed, READ the SAFETY INSTRUCTIONS of this manual FIRST! Be sure that all electrical installations (including all safety systems) comply with all required regulations of the regional authorities. This includes lightning conductor, personal protection switch etc.

D.8.1 Installation with looped in AC-Control box

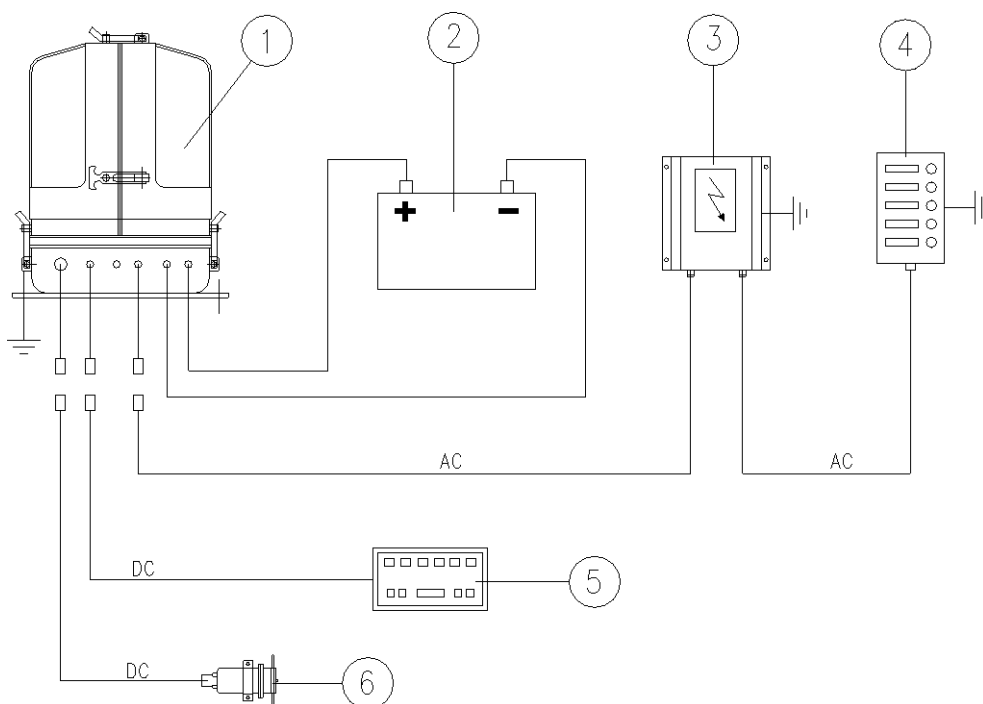

- | | |
|-------------------|-------------------------|
| 1. Generator | 4. Distribution panel |
| 2. Battery | 5. Remote control panel |
| 3. AC-Control Box | 6. Fuel pump |

Fig. D.8.1-1: Installation with looped in AC-Control box

All electrical safety installations have to be made on board.

D.8.2 Installation AC-Box / distribution panel separate connected

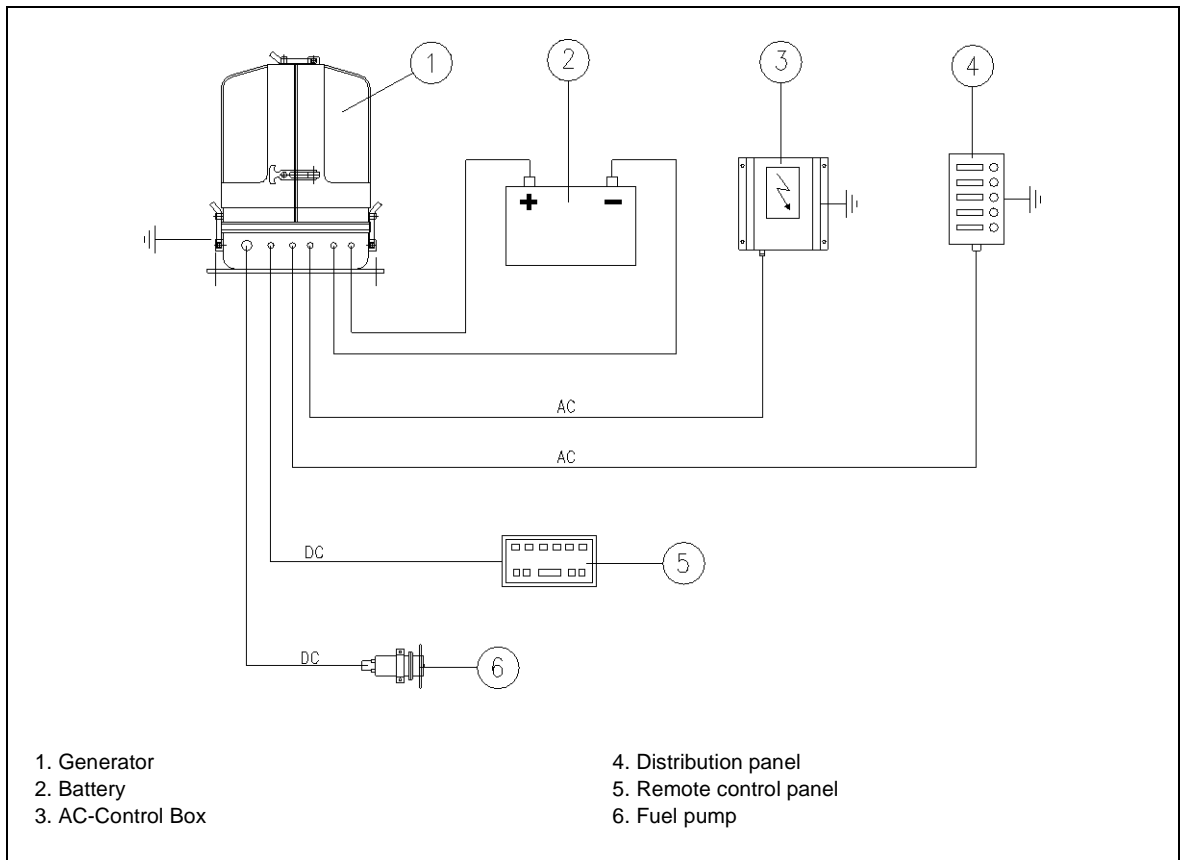

Fig. D.8.2-1: Installation AC-Box / distribution panel separate connected

A power source selector switch must be installed between the generator (or if applicable, AC-Control box) and the ship's electrical supply system. This switch must be used to ensure that all AC consumers can be switched off at once. This switch should also be installed to keep the generator and shore (grid) power systems separate.

A 3-way cam switch should be used. This switch basic positions: "Shore power" - "OFF" - "Generator". If an (DC-AC) inverter is used, a fourth position will be required.

- 0. OFF
- I. Generator
- II. Shore power connection
- III. Inverter

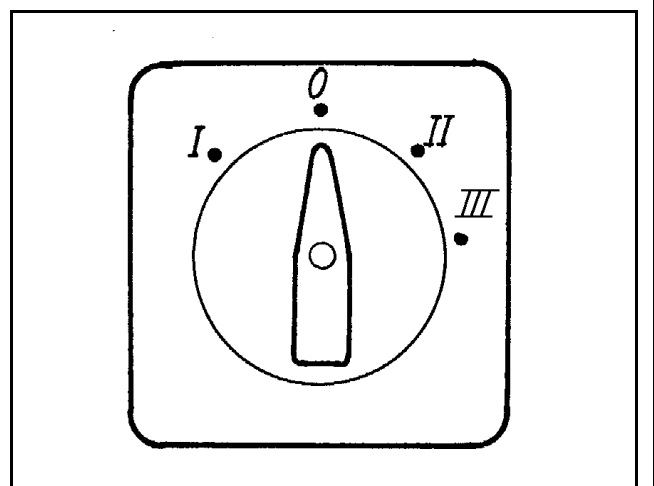

Fig. D.8.2-2: 3-Way Cam Switch

The cam-type switch must have 2 poles, so that "MP" and "phase" can be switched off.

If a 3-phase current system is also installed with the option of supplying from either the generator or shore power, an additional switch must be installed to keep these systems separate.

An alternative to a manual rotating switch is an automatic power relay. When the generator is not running, the relay remains in the shore power position. As soon as the generator is running, the power relay switches automatically to the generator position.

Note: If the system has both single and 3-phase AC, it is CRITICAL that the two systems remain SEPARATE!

Protection conductor

The generator is provided with a PEN safety system, as standard, which connects the 3-phase delta centre point "N" to the safety ground strap.

If a separate ground protection cable is necessary (i.e. due to national safety regulations), the bridge between the generator housing and ground (in the AC-Control box) must be disconnected. Once such a ground protection cable is installed, it must be connected to the ground straps of all on board electrical devices.

In order to monitor the electrical system, it is recommended to install a voltmeter (and, if possible, a current meter) down line from the power source selector switch so that all respective power sources can be monitored. A separate voltmeter for the generator, itself, is therefore not required.

Electrical fuses

It is absolutely essential that the electrical system installation is inspected by a qualified electrical technician. The generator should have its own AC input electrical fuses. The fuses should be sized such that the rated current of the generator on each of the individual phases is not exceeded by more than 25%.

Data for gensets with power output greater than 30 kW on request!

The fuses must be of the slow type. A 3-way motor protection switch must be installed to protect the electrical motor.

Required fuses see *Tabelle 8, "Rated current," auf Seite 112*

Required cable cross-sections

The following recommended electrical cable dimensions (cross sections) are the minimum required sizes for a safe installation. (siehe *Tabelle 9, "Cable cross-section," auf Seite 112*)

D.8.3 AC Control Box with VCS and ASB

The required capacitors for the excitation of the generator are located in the AC-Control box, as well as the electronic control for voltage/speed regulation (VCS) and the starting current reinforcement (ASB). The AC-Control box must be connected by electrical wires (high voltage and low-voltage) to the generator.

The front panel must always be closed, since the AC-Control box produces 400 V during operation.

The AC-Control box must be electrically connected to the generator (high and low voltage).

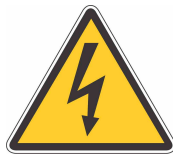

Danger - High voltage

ATTENTION! Before working on the System read the "Section Safety Instructions in this Manual".

1. Inlet VCS-connection (X1)
2. Inlet measuring voltage (X3)
3. Excitation cable to generator (X4)

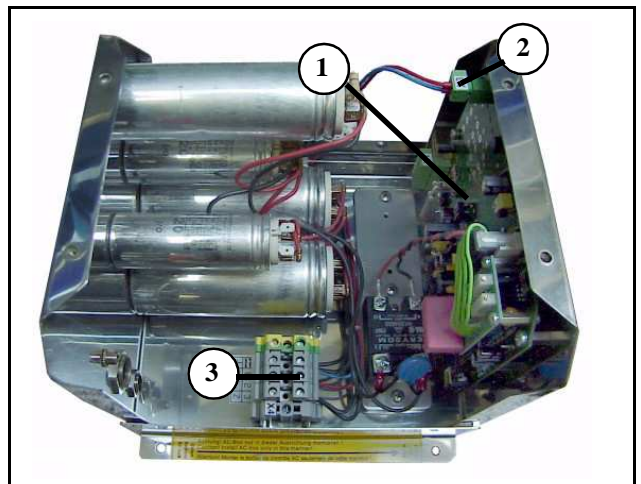

Fig. D.8.3-1: Opened AC Control Box

From Panda 30 upwards



Fig. D.8.3-2: Opened AC Control Box from Panda 30 upwards

D.8.4 VCS Voltage Control

All Panda generators from Panda 8000 upwards are fitted with the electronic voltage control "VCS" as standard.

The VCS controls the generator voltage and motor speed. A actuator on the injection pump can increase the engine speed by up to 8%.

If the generator is run without load, the voltage should be 231V with a frequency of approx 48.5 to 49Hz. The frequency (equates to the speed) can be increased by up to 8%. This ensures that the engine speed is increased when there is an extra load. The maximum speed is achieved when 80% load is reached.

The speed gauge is governed by an adjusting screw, above and below. Adjustment of this screw may not occur without the expressive approval of the manufacturer.

All signals pass through the circuit board in the AC-Control box. The signal impulse for the actuator is passed to the electric motor by means of the 5 core wire.

The generator maintains its full capability if the VCS has a defect.

In this case the base current must be raised to at least 240 V by adjusting the minimum setting on the speed gauge, in order to ensure that the generator output voltage at 70% nominal load does not drop below 215 V.

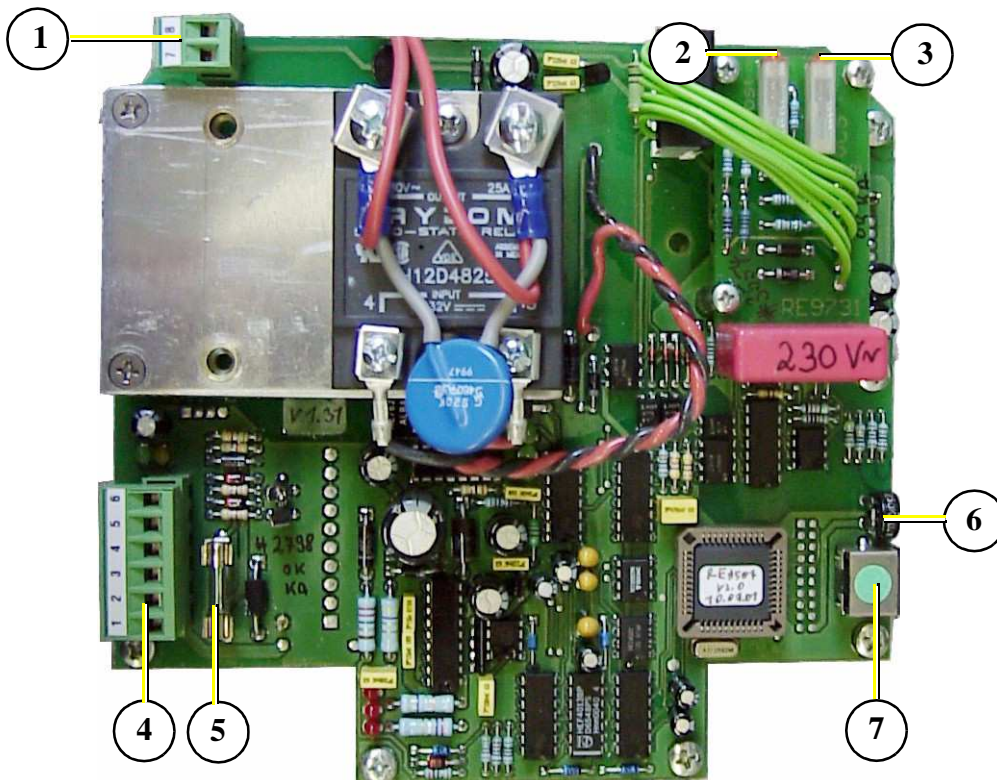

- | | |
|---|--|
| 1. Connection measuring voltage | 5. Electrical fuse (1.6 A, slow to blow) |
| 2. Adjusting booster voltage (do not adjust!) | 6. Potentiometer for booster time |
| 3. Adjustment VCS-voltage | 7. Connection for PC |
| 4. Connection VCS inlet | |

Fig. D.8.4-1: VCS Control

D.8.5 Jump Start at High Starting Current (Booster)

Additionally, the automatic start booster is located on the circuit control board. The starting current is increased by connecting a second group of capacitors (C2), if the voltage drops below a pre-set voltage. The starting current can be increased by 300% for a short period by combining both components voltage/speed control and ASB Start booster.

D.9 Insulation Test



ATTENTION: Once the electrical system installation is complete, a ground insulation test must be performed as follows:

- 1.) Switch off all on-board electrical devices.
- 2.) Start the generator.
- 3.) Measure the AC-voltage with a voltmeter (adjust to Volt/AC) between
 - a) generator housing and AC-Control box
 - b) generator housing and ground.

The measured voltage must not exceed 50mV (millivolts).
4. Once the safety systems have been installed, they must be checked. If a Leakage Current Relay has been installed, it also has to be tested, in order to ensure that it functions properly. The individual phrases must be checked against each other, and between phase and ground, (the single phase or 4th phase also needs to be checked in this fashion).
5. If the generator is protected by a ground connection, then ALL electrical devices must also be connected to this "common" ground (usually ground contacts are attached to the devices' metallic housings).

The electrical system installation must also comply with the hook-up requirements of the shore current grid. Generally a leakage current relay is sufficient for safe electrical operation; however, this must be confirmed by the electrical safety standard in the region where the system is attached to a main land power grid. The relay has to meet the required safety standard regulations.

Checking the Electrical Connections

There is always the possibility that circuits have been rerouted/changed or individual components have not been not been correctly laid out on the circuit diagrams.

The installation electrician should therefore check and label all electrical connections to ensure that they correspond to the main circuit diagram. The inspection and correct labelling is especially critical for terminals L1/ L2/L3/L1'/N (for the 230 V - 50 Hz model) and for terminals L1/L2/L3/N & 1/ 2/ 4 for the 60 Hz (120 V) models. The electrician is therefore obliged, before installation to check whether the generator is earth-free. As long as this test has not been carried out all other components for electrical installation must be removed. Once the system has been installed and inspected, this test should also be performed with all electrical devices (i.e. voltage check between common and metallic housings) while the generator is running.

Blank

E. Tables

E.1 Troubleshooting

GENERATOR OUTPUT VOLTAGE TOO LOW

For 50 Hz versions: less than 200 V

Cause	Solution
Generator is overloaded.	Reduce the electrical load (switch off load)
Motor is not reaching the rated rpm.	Refer to "motor faults" section.
Defective capacitor(s).	Check capacitors and replace if necessary.

GENERATOR VOLTAGE TOO HIGH (MORE THAN 240 V - 50 Hz)

If the generator is providing excessively high voltage, the following potential causes should be investigated:

Cause	Solution
Over-energizing due to wrong capacitors.	Check capacitors type and replace if necessary.
Measuring voltage on the VCS circuit board is missing.	Check VCS System, check cable connections.

GENERATOR VOLTAGE FLUCTUATES

Cause	Solution
1. Disturbances on the electrical system/user side. 2. Motor disturbances.	1. Check if electrical load is fluctuating. 2. Refer to section: "Motor runs irregular".

GENERATOR NOT ABLE TO START ELECTRIC MOTOR

Cause	Solution
If the generator is unable to supply enough power to start an electric motor (230 V - 50 Hz), it is usually because the motor draws too much current during starting process.	Check the motor's current draw required for starting (switch to 380 V, if possible). This could be remedied by providing stronger capacitors or installing an optional "Easy Start Booster Set" (see Appendix). Enquire at your nearest Panda dealer or directly at the manufacturer.

DIESEL MOTOR FAILS TO START	
Cause	Solution
Starter battery switched "OFF".	Check position of battery switch and switch "ON" (if installed).
Starter battery voltage insufficient (battery too weak).	Inspect battery terminals and cables for a good electrical connection (Inspect against corrosion, tattered wires, etc.).
Starting current disrupted.	During the normal starting process, the battery voltage drops to 11V with a fully charged battery. If the voltage does not drop during starting, the electrical connection is faulty. If the battery voltage drops lower than 11V, then the battery has been discharged.

STARTER IS TURNING MOTOR, BUT FAILS TO START	
Cause	Solution
Fuel inlet solenoid valve not opening.	Check wire connections and circuitry to solenoid valve. (ref. DC wiring diagram: Relay K2, Fuse)
Fuel pump not working.	Check fuel-filter and pump: clean if necessary.
Lack of fuel.	Check fuel supply.
Glow-plugs not working correctly.	Check glow plugs and heating time.
Too much air in fuel lines.	Test fuel system for leakage. Bleed air from fuel system (refer to section "Bleeding Air from Fuel System").
Fuel-filter blocked.	Replace fuel filter.

MOTOR DOES ACHIEVE ENOUGH SPEED DURING STARTING PROCESS	
Cause	Solution
Starter battery voltage insufficient.	Check battery.
Damaged bearing(s) piston (seized).	Repairs need to be carried out by Kubota-Service. (refer to Kubota motor-manual)
Cooling water in combustion chamber.	<ol style="list-style-type: none"> 1. Turn generator "OFF" at control panel. 2. Remove the glow plug (see Kubota-manual). 3. Rotate the motor by hand carefully. 4. Check if there is water in the oil and change both oil and filter if necessary. 5. Determine cause for excess water in the combustion chamber. The excess water can be caused by a defective air vent in the cooling water system, which should be checked and cleaned, or replaced if faulty.

MOTOR DOES NOT ACHIEVE ENOUGH SPEED DURING STARTING PROCESS	
Cause	Solution
Starter battery voltage insufficient.	Check battery.
Damaged bearing(s) piston (seized).	Repairs need to be carried out by Kubota-Service. (refer to Kubota motor-manual)
Cooling water in combustion chamber.	<ol style="list-style-type: none"> 1. Turn generator "OFF" at control panel. 2. Remove the glow plug (see Kubota-manual). 3. Rotate the motor by hand carefully. 4. Check if there is water in the oil and change both oil and filter if necessary. 5. Determine cause for excess water in the combustion chamber. The excess water can be caused by a defective air vent in the cooling water system, which should be checked and cleaned, or replaced if faulty.

MOTOR SPEED DROPS	
Cause	Solution
Lack of fuel	Check fuel supply system: <ul style="list-style-type: none"> - fuel filter, renew if necessary - check fuel pump - check fuel lines (bleed if necessary)
Lack of intake air.	Check air intake paths. Check and clean air filter (and intake muffler if installed).
Generator overloaded by too many load.	Reduce the electrical load (switch off load).
Generator overloaded by over-energizing.	Check that the proper capacitor type is installed and that they are connected correctly.
Defective generator (windings, bearings, or other).	Generator must be sent to manufacturer for repair of damaged bearings or winding.
Damaged engine.	Repair of bearing damage, etc., by Kubota-Service.

MOTOR RUNS IN OFF POSITION	
Cause	Solution
Fuel inlet solenoid valve or throttle shut solenoid is not switching off.	Check wire connections to solenoid. Check valve functions as in the "Fuel Solenoid Valve" or in the throttle shut off solenoid sections. Replace if necessary.

MOTOR STOPS BY ITSELF	
Cause	Solution
Lack of fuel.	Check fuel supply system.
Excess heat in cooling system (thermo switch tripped)-lack of cooling water. Is indicated on the remote control panel.	Check cooling water system flow: water pump, inlet water filter, extra heat exchanger coolant flow.
Lack of oil (oil pressure sensor tripped). Is indicated on the remote control panel.	Check oil-level and if necessary top up. Check motor's oil-pressure and have repaired by Kubota-Service if necessary.

SOOTY, BLACK EXHAUST	
Cause	Solution
Generator is overloaded.	Check electrical load and switch off unnecessary load.
Insufficient intake air.	Check intake air filter; clean if necessary.
Fuel injector faulty.	Replace injector.
Valve clearance incorrect.	Readjust valve clearance to correct value (refer to Farymann-manual).
Poor fuel quality.	Use better quality diesel (recommended: 2-D Diesel).
Poor combustion.	Incorrect AFR (air/fuel ratio) due to motor timing adjustment. Have motor serviced by Kubota.

GENERATOR MUST BE SHUT OFF IMMEDIATELY IF:	
Cause	Solution
<ul style="list-style-type: none"> - motor rpm suddenly rises or drops - unusual noise comes from genset - exhaust colour suddenly becomes dark - leakage in the cooling water system. 	Refer to respective section of manual and if necessary, have repaired by Kubota-Service, or Panda representative.



Table 1: Resistor generator coil HP1

	L-N[Ohm]	L-Z[Ohm]
Mains	120V / 60Hz	
Panda 8000	ca. 0,7	ca. 0,7
Panda 9000	ca. 0,65	ca. 0,65
Panda 12000	ca. 0,45	ca. 0,45
Panda 18	ca. 0,2	ca. 0,2
Panda 24	ca. 0,06	ca. 0,06
Mains:	230V / 50Hz	
Panda 8000	ca. 0,9	ca. 0,9
Panda 9000	ca. 0,8	ca. 0,8
Panda 12000	ca. 0,3	ca. 0,3
Panda 14000	ca. 0,25	ca. 0,25
Panda 18	ca. 0,25	ca. 0,25
Panda 24	ca. 0,17	ca. 0,17
Panda 30	ca. 0,1	ca. 0,1

Table 2: Inductance generator coil HP1

	L-N[Ohm]	L-Z[Ohm]
Maint	120V / 60Hz	
Panda 8000	ca. 2,8	ca. 2,8
Panda 9000	ca. 2,8	ca. 2,8
Panda 12000	ca. 3,5	ca. 3,5
Panda 18	ca. 3,2	ca. 3,2
Panda 24	ca. 0,3	ca. 0,3
Mains	230V / 50Hz	
Panda 8000	ca. 3,7	ca. 3,7
Panda 9000	ca. 3,7	ca. 3,7
Panda 12000	ca. 3,5	ca. 3,5
Panda 14000	ca. 2,3	ca. 2,3
Panda 18	ca. 1,8	ca. 1,8
Panda 24	ca. 1,3	ca. 1,3
Panda 30	ca. 0,9	ca. 0,9

Table 3: Resistore generator coil DVS

	L1-N[Ohm]	L2-N[Ohm]	L3-N[Ohm]	L1'-N[Ohm]	1-2[Ohm]	3-4[Ohm]
Mains	120V / 60Hz					
Panda 8000	ca. 0,7	ca. 0,7	ca. 0,7	ca. 0,15	ca. 0,15	
Panda 9000	ca. 0,65	ca. 0,65	ca. 0,65	ca. 0,17	ca. 0,17	
Panda 12000	ca. 0,45	ca. 0,45	ca. 0,45	ca. 0,15	ca. 0,15	
Panda 18	ca. 0,2	ca. 0,2	ca. 0,2	ca. 0,05	ca. 0,05	
Panda 24	ca. 0,06	ca. 0,06	ca. 0,06			
Mains:	230V / 50Hz					
Panda 8000	ca. 0,9		ca. 0,9		ca. 0,9	ca. 0,4
Panda 9000	ca. 0,8		ca. 0,8		ca. 0,8	ca. 0,4
Panda 12000	ca. 0,3		ca. 0,3		ca. 0,3	ca. 0,2
Panda 14000	ca. 0,25	ca. 0,25	ca. 0,25	ca. 0,12		
Panda 18	ca. 0,25	ca. 0,25	ca. 0,25	ca. 0,1		
Panda 24	ca. 0,17	ca. 0,17	ca. 0,17	ca. 0,1		
Panda 30	ca. 0,1	ca. 0,1	ca. 0,1	ca. 0,08		

Table 4: Inductance generator coil DVS

	L1-N[mH]	L2-N[mH]	L3-N[mH]	L1'-N[mH]	1-2[mH]	3-4[mH]
Mains	120V / 60Hz					
Panda 8000	ca. 2,8	ca. 2,8	ca. 2,8	ca. 0,8	ca. 0,8	
Panda 9000	ca. 2,8	ca. 2,8	ca. 2,8		ca. 0,9	ca. 0,9
Panda 12000	ca. 3,5	ca. 3,5	ca. 3,5	ca. 1,0	ca. 1,0	
Panda 18	ca. 3,2	ca. 3,2	ca. 3,2		ca. 0,4	ca. 0,4
Panda 24	ca. 0,3	ca. 0,3	ca. 0,3			
Mains:	230V / 50Hz					
Panda 8000	ca. 3,7	ca. 3,7	ca. 3,7	ca. 2,3		
Panda 9000	ca. 3,7	ca. 3,7	ca. 3,7	ca. 2,3		
Panda 12000	ca. 3,5	ca. 3,5	ca. 3,5	ca. 2,3		
Panda 14000	ca. 2,3	ca. 2,3	ca. 2,3	ca. 1,5		
Panda 18	ca. 1,8	ca. 1,8	ca. 1,8	ca. 1,1		
Panda 24	ca. 1,3	ca. 1,3	ca. 1,3	ca. 0,8		
Panda 30	ca. 0,9	ca. 0,9	ca. 0,9	ca. 0,6		

Table 5: Voltage values stator coil

Terminal	Panda 8000	Panda 9000	Panda 12000	Panda 14000	Panda 18	Panda 24	Panda 30
L1 - L2	3-5 Volt	4-6 Volt	5-7 Volt	6-9 Volt	6-10 Volt	6-11 Volt	7-12 Volt
L2 - L3	3-5 Volt	4-6 Volt	5-7 Volt	6-9 Volt	6-10 Volt	6-11 Volt	7-12 Volt
L3 - L1	3-5 Volt	4-6 Volt	5-7 Volt	6-9 Volt	6-10 Volt	6-11 Volt	7-12 Volt
L1' - N (50Hz)	~ 2-3 Volt	~ 2-3 Volt	~ 3-4 Volt	~ 3-5 Volt	~ 3-5 Volt	~ 3-5 Volt	~ 3-6 Volt
4 - 2 (60Hz)	~ 2-3 Volt	~ 2-3 Volt	~ 3-4 Volt		~ 3-5 Volt	~ 3-5 Volt	

Table 6: Voltage values stator coil

Terminal	Panda 8000	Panda 9000	Panda 12000	Panda 14000	Panda 18	Panda 24	Panda 30
L - N	~ 2-3 Volt	~ 2-3 Volt	~ 3-4 Volt	~ 3-5 Volt	~ 3-5 Volt	~ 3-5 Volt	~ 3-6 Volt
4 - 2 (60Hz)	~ 2-3 Volt	~ 2-3 Volt	~ 3-4 Volt		~ 3-5 Volt	~ 3-5 Volt	

Table 7: Diameter of conduits

Generator type	Ø Cooling water conduit		Ø Exhaust conduit [mm]	Ø Fuel conduit	
	Frehwater [mm]	Seawater [mm]		Supply [mm]	Return [mm]
Panda PMS 3,8 ND	12	12	30	8	8
Panda PMS 4,5 ND	12	12	30	8	8
Panda PMS 4500 SCB	12	12	30	8	8
Panda PMS 5000 SCE	12	12	30	8	8
Panda PMS 4500 FCB	12	12	30	8	8
Panda PMS 5000 LPE	16	16	30	8	8
Panda PMS 6000 ND	20	20	40	8	8
Panda PMS 8000 NE	20	20	40	8	8
Panda PMS 9000 ND	20	20	40	8	8
Panda PMS 12000 NE	20	20	40	8	8
Panda PMS 14000 NE	20	20	40	8	8
Panda PMS 18 NE	25	20	50	8	8
Panda PMS 24 NE	25	20	50	8	8
Panda PMS 30 NE	25	20	50	8	8
Panda PMS 33 KU	30	25	50	8	8
Panda PMS 42 KU	30	30	50	8	8
Panda PMS 32 YA	30	30	50	8	8
Panda PMS 50 YA	30	30	60	8	8
Panda PMS 60 YA	-	-	60	8	8
Panda PMS 50 MB	40	30	60	8	8
Panda PMS 60 MB	40	40	60	8	8
Panda PMS 75 MB	40	30	60	8	8
Panda PMS-HD 7,5-4 KU	25	20	40	8	8
Panda PMS-HD 09-4 KU	25	20	50	8	8
Panda PMS-HD 12-4 KU	25	20	50	8	8
Panda PMS-HD 17-4 KU	25	25	60	8	8
Panda PMS-HD 22-4 KU	30	30	60	8	8
Panda PMS-HD 30-4 KU	30	30	60	8	8
Panda PMS-HD 40-4 KU	30	30	60	8	8
Panda PMS-HD 60-4 DZ	-	-	-	-	-
Panda PMS-HD 70-4 DZ	-	-	-	-	-
Panda PMS-HD 85-4 DZ	-	-	-	-	-
Panda PMS-HD 110-4 DZ	-	-	-	-	-
Panda PMS-HD 130-4 DZ	-	-	-	-	-

Table 8: Rated current

Panda 8000 - 230 V / 50 Hz Panda 8000 - 400 V / 50 Hz Panda 8000 - 120 V / 60 Hz	27,0 A 8,3 A 61,8 A		Panda 18 - 230 V / 50 Hz Panda 18 - 400 V / 50 Hz Panda 18 - 120 V / 60 Hz	60,3 A 20,0 A 128,0 A
Panda 9000 - 230 V / 50 Hz Panda 9000 - 400 V / 50 Hz Panda 9000 - 120 V / 60 Hz	34,9 A 11,1 A 74,5 A		Panda 24 - 230 V / 50 Hz Panda 24 - 400 V / 50 Hz Panda 24 - 120 V / 60 Hz	89,1 A 30,1 A 161,1 A
Panda 12000 - 230 V / 50 Hz Panda 12000 - 400 V / 50 Hz Panda 12000 - 120 V / 60 Hz	41,7 A 13,7 A 89,0 A		Panda 30 - 230 V / 50 Hz Panda 30 - 400 V / 50 Hz Panda 30 - 120 V / 60 Hz	Anfrage 35 A 219 A
Panda 14000 - 230 V / 50 Hz Panda 14000 - 400 V / 50 Hz Panda 14000 - 120 V / 60 Hz	48,0 A 15,2 A 112,7 A			

Table 9: Cable cross-section

Voltage	Required cable cross-section						
	< 6 kW	6-10 kW	10-15 kW	15-20 kW	20-35 kW	35-45 kW	45-65 kW
120V 1-ph.	4x6mm ²	4x10mm ²	4x16mm ²	4x25mm ²	4x35mm ²	4x50mm ²	4x70mm ²
230V 1-ph.	2x4mm ²	2x6mm ²	2x10mm ²	2x16mm ²	2x25mm ²	2x35mm ²	2x35mm ²
400V 3-ph.	4x2,5mm ²	4x4mm ²	4x6mm ²	4x10mm ²	4x16mm ²	4x16mm ²	4x25mm ²



Table 10: Technical Data

	Panda 6000 ND	Panda 8000 NE	Panda 9000 ND	Panda 12000 NE	Panda 14000 NE	Panda 18 NE	Panda 24 NE	Panda 30 NE
Type	Z482	Z482	D722	D722	D782	D1105	V1505	V1505 TD
Governor	mechanical	VCS	mechanical	VCS	VCS	VCS	VCS	VCS
Automatic startbooster	yes	yes	yes	yes	yes	yes	yes	yes
Cylinder	2	2	3	3	3	3	4	4TD
Bore	67mm	67mm	67mm	67mm	67mm	78mm	78mm	78mm
Stroke	68mm	68mm	68mm	68mm	73,6mm	78,4mm	78,4mm	78,4mm
Stroke volume	479cm ³	479cm ³	719cm ³	719cm ³	782cm ³	1123cm ³	1498cm ³	1498cm ³
Max. power (DIN 6271-NB) at 3000rpm	9,32kW	9,32kW	14,0kW	14,0kW	13,5kW	18,7kW	23,3kW	31,3kW
Rated speed 50 Hz	3000rpm	3000rpm	3000rpm	3000rpm	3000rpm	3000rpm	3000rpm	3000rpm
Idle running speed ^a	3120rpm	2900rpm	3120rpm	2900rpm	2900rpm	2900rpm	2900rpm	2900rpm
Valve clearance (engine cold)	0,2mm	0,2mm	0,2mm	0,2mm	0,2mm	0,2mm	0,2mm	0,2mm
Cylinder head nut torque	42Nm	42Nm	42Nm	42Nm	68Nm	68Nm	68Nm	68Nm
Compression ratio	23:1	23:1	23:1	23:1	23:1	22:1	22:1	23:1
Lubrication oil capacity	2,5l	2,5l	3,8l	3,8l	3,8l	5,1l	6,0l	6,7l
Fuel consumption ^b	ca. 0,53-1,4l	ca. 0,68-1,8l	ca. 0,79-2,1l	ca. 1,05-2,8l	ca. 1,25-3,3l	ca. 1,68-4,5l	ca. 2,20-5,85	ca. 2,7-7,2l
Oil consumption	max. 1% of fuel consumption							
Cooling water requirement for seawater circuit	16-28l/min	16-28l/min	16-28l/min	16-28l/min	16-28l/min	28-40l/min	28-40l/min	40-50l/min
Permissible max. permanent tilt of engine	a) 25° across the longitudinal axis b) 20° in the longitudinal direction							

a. progressive speed by VCS

b. 0,35l/kW electrical power, the randomized values between 30% and 80% of the rated speed

Table 11: Technical Data

	Panda 33 KU	Panda 42 KU	Panda 32 YA	Panda 50 YA	Panda 60 YA	Panda 50 MB	Panda 60 MB	Panda 75 MB
Type	V2203	F2803	4JH3E	4JH3TE	4JH3HTE	OM 601	OM 602	OM 603
Governor	VCS	VCS	VCS	VCS	VCS	VCS	VCS	VCS
Automatic startbooster	yes	yes	yes	yes	yes	yes	yes	yes
Cylinder	4	5	4		4	4	5	6
Bore	87mm	87mm	84mm	mm	84mm	89mm	89mm	89mm
Stroke	92,4mm	92,4mm	90mm	mm	90mm	92,4mm	92,4mm	92,4mm
Stroke volume	2197cm ³	2746cm ³	cm ³	cm ³	cm ³	2298cm ³	2874cm ³	3000cm ³
Max. power (DIN 6271-NB) at 3000rpm	32,7kW	40,8kW	kW	kW	kW	58kW	70kW	75kW
Rated speed 50 Hz	3000UpM	3000UpM	3000UpM	3000UpM	3000UpM	3000UpM	3000UpM	3000UpM
Idle running speed ^a	2900UpM	2900UpM	2900UpM	2900UpM	2900UpM	2900UpM	2900UpM	2900UpM
Valve clearance (engine cold)	0,2mm	0,2mm	0,2mm	0,2mm	0,2mm	0,2mm	0,2mm	0,2mm
Cylinder head nut torque	98Nm	98Nm	Nm	Nm	Nm	25Nm	25Nm	25Nm
Compression ratio	23:1	23:1				22:1	22:1	22:1
Lubrication oil capacity	9,5l	12,0l				7,0l	7,5l	7,5l
Fuel consumption ^b	ca. 2,94-7,5l	ca. 3,8-10,1l	ca. 2,9-7,8l	ca. 4,3-11,5	ca. 5,5-14,6l	ca. 4,4-11,8l	ca. 5,4-14,3l	ca. 6,8-18,2l
Oil consumption	max. 1% of fuel consumption							
Cooling water requirement for seawater circuit	50-60l/min	50-60l/min	50-60l/min	50-60l/min	60-75l/min	50-60l/min	60-75l/min	75-85l/min
Permissible max. permanent tilt of engine	a) 25° across the longitudinal axis b) 20° in the longitudinal direction							

a. progressive speed by VCS

b. 0,35l/kW electrical power, the randomized values between 30% and 80% of the rated speed



E.2 Types of coil

HP1 - 230V / 50 Hz

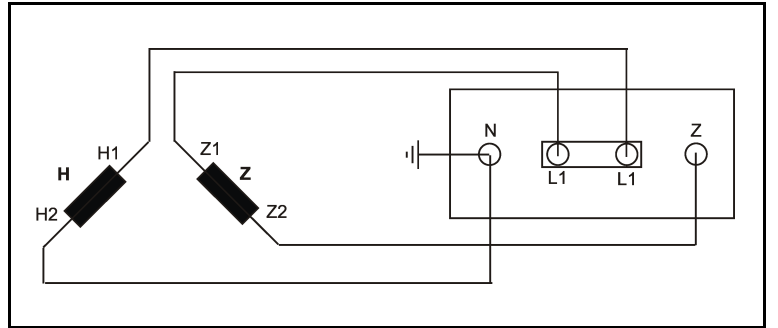

HP1 - 120V / 60 Hz

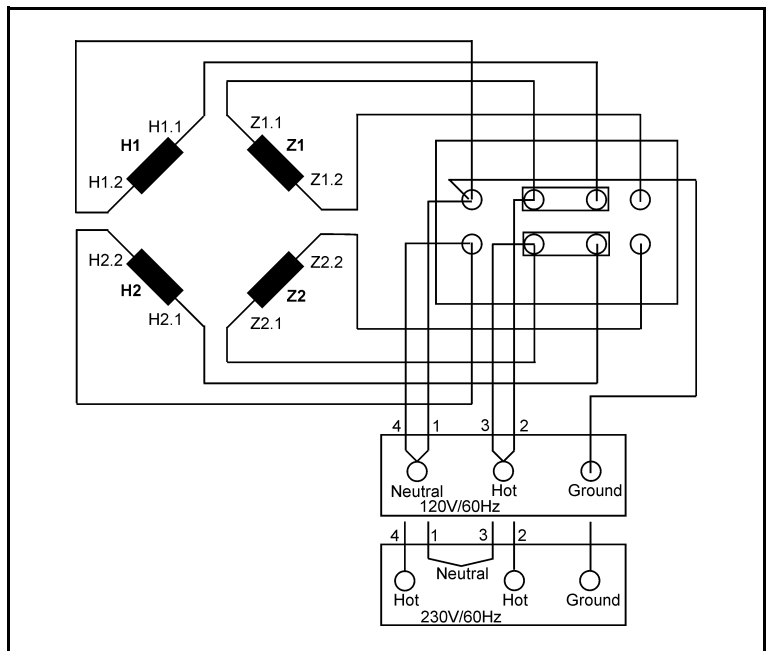

HP3 - 400V / 50 Hz

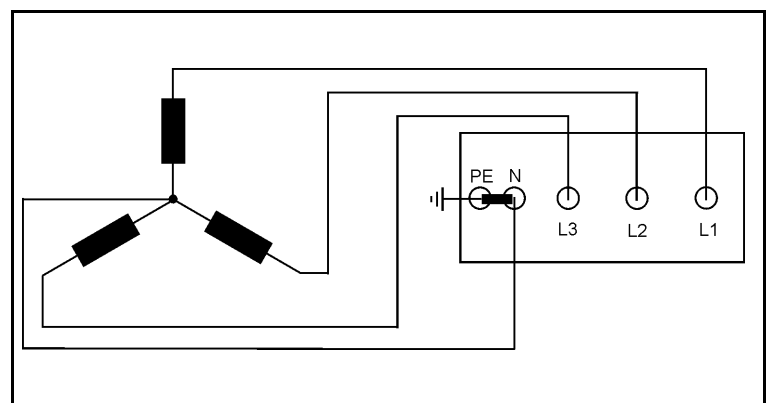

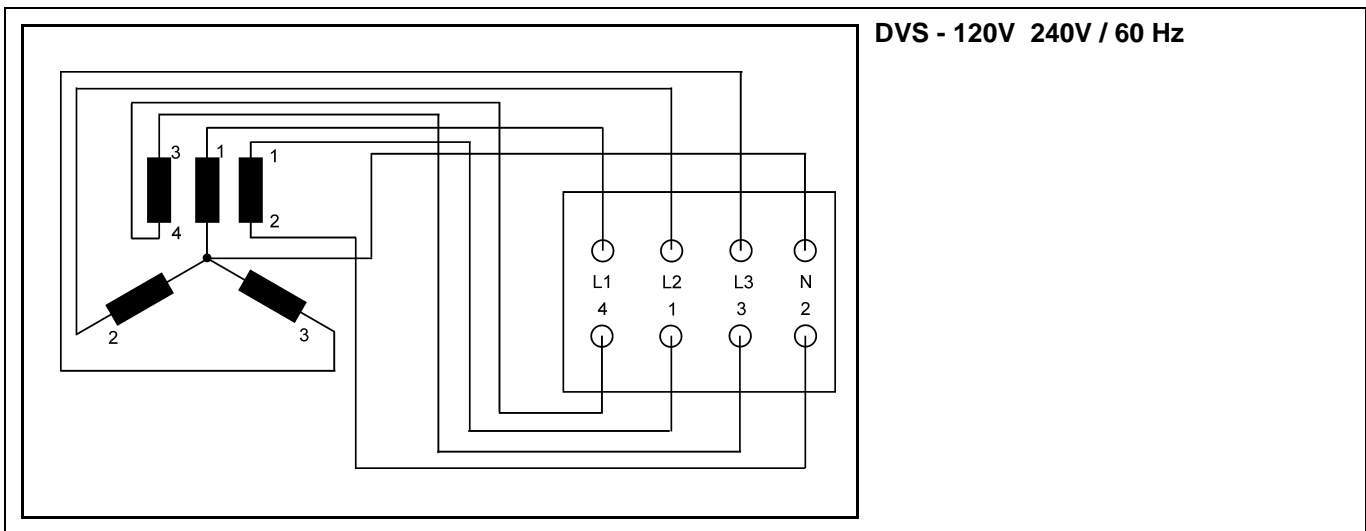
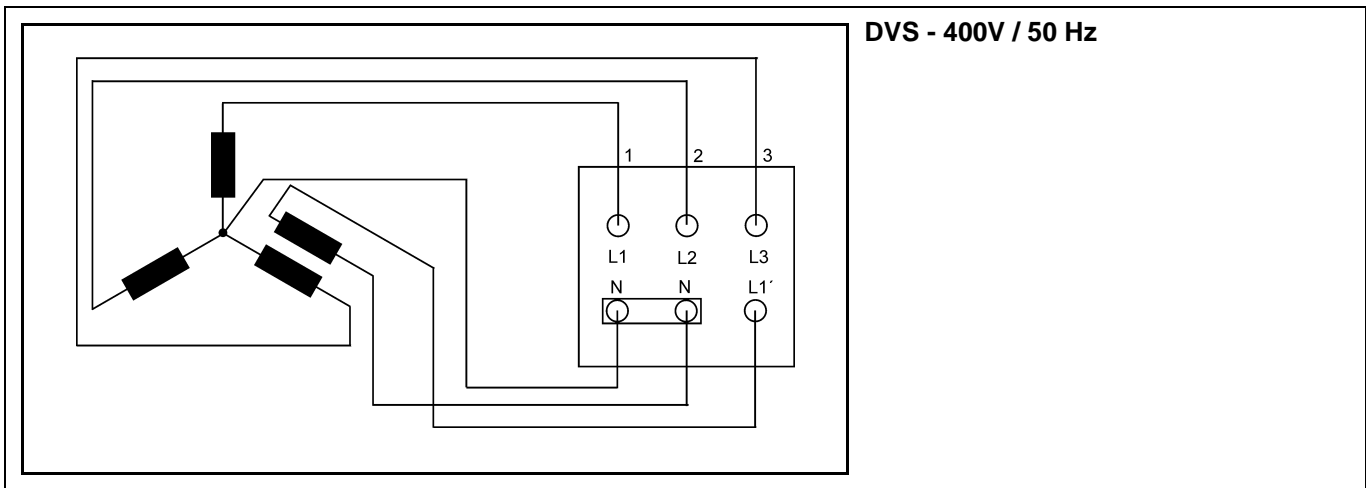
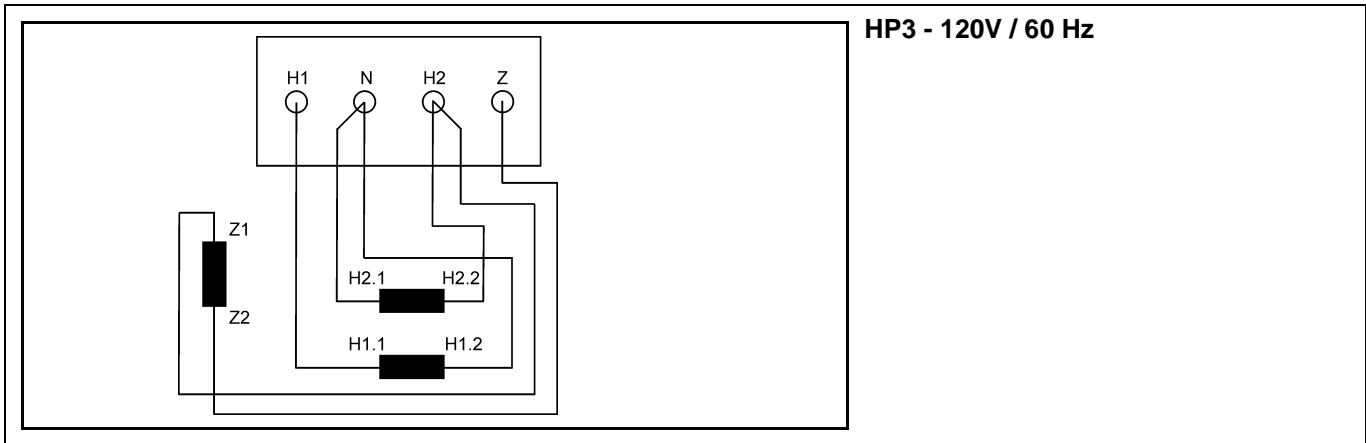

E.3 Inspection checklist for services

Inspection-Category			
A	Installation check /	D	100 h
		E	500 h
B	daily	F	1000 h
C	35 - 50 h	G	5000 h

Inspection work			
1)	check r	4)	changer
2)	measure	5)	sealing
3)	clean	6)	check isolation

	Inspection-Category							Inspection work
	A	B	C	D	E	F	G	
01.	5)	5)	5)	5)	5)	5)	4)	coolant water hoses
02.	1)	1)	1)	1)	1)	4)	4)	raw water pump (impeller)
03.	1)	1)	3)	3)	3)	3)	3)	water separator / fuel pre-filter
04.	1)	1)	4)	4)	4)	4)	4)	engine oil
05.				3)	3)	3)	3)	oil strainer / oil filter
06.	1)	1)	1)	4)	4)	4)	4)	air filter
07.	1)	1)	1)	1)	1)	1)	1)	fuel lines (leaks)
08.	1)	1)	1)	4)	4)	4)	4)	fine particle fuel filter
09.	1)		1)		1)	1)	1)	valve clearance
10.	1)	1)	4)	5)	4)	4)	4)	valve cover gasket
11.			1)		1)	1)	1)	coolant therm (sensor)
12.			1)		1)	1)	1)	exhaust temp sensor
13.			1)		1)	1)	1)	oil pressure sensor
14.		1)	1)	1)	1)	1)	1)	belt tension
15.	1)	1)	1)	1)	4)	4)	4)	toothed-belt
16.						1)	1)	thermostat
17.	1)	1)	1)	1)	1)	1)	1)	generator & engine screws
18.	1)	1)	1)	1)	1)	1)	1)	unit's base mount screws
19.	6)	6)	6)	6)	6)	6)	6)	check electrical cables
20.	1)	1)	1)	1)	1)	1)	1)	motor reinforced mountings
21.	1)	1)	1)	1)	1)	1)	1)	starter motor mounting screws
22.	1)	1)	1)	1)	1)	1)	1)	screws generator-engine
23.	2)		2)	2)	2)	2)	2)	input temp of coolant under load
24.	2)		2)	2)	2)	2)	2)	outlet temp of coolant under load
25.						4)	4)	generator rotor bearing
26.			1)	1)	1)	1)	1)	signs of corrosion to generator
27.			1)	1)	1)	1)	1)	check generator coolant block
28.			1)	1)	1)	1)	1)	capacitors in AC-Control box
29.	1)		1)	1)	1)	1)	1)	ASB function test
30.	1)		1)	1)	1)	1)	1)	VCS function test
31.	2)		2)	2)	2)	2)	2)	voltage without load
32.	2)		2)	2)	2)	2)	2)	voltage under load
33.	2)		2)	2)	2)	2)	2)	generator output under load
34.	2)		2)	2)	2)	2)	2)	engine speed (rpm)
35.						1)	4)	injector test
36.						1)	1)	compression
37.	1)	1)	1)	1)	1)	1)	1)	hose clips

E.4 Engine oil

Engine oil classification

Operating range:

The operating range of an engine oil is determined by SAE class. "SAE" is for the union of American engineers (Society of Automotives Engineers). The SAE class of an engine oil only informs over the viscosity of the oil (larger number = more viscous, lower number = more highly liquidly) e.g. to 0W, 10W, 15W, 20, 30, 40. The first number shows the liquid of cold weather, the second number refers to the fluidity with heat. Complete yearly oils have usually SAE 10W-40, SAE 15W-40 etc.

Quality of oil:

The quality of an engine oil is specified by the API standard ("American Petroleum Institutes"). The API designation is to be found on each engine oil bundle. The first letter is always a C.

API C for diesel engines

The second letter is for the quality of the oil. The more highly the letter in the alphabet, the better the quality.

Examples for diesel engine oil:

API CG Engine oil for highest demands, turbo-tested

Engine oil types	
above 25°C	SAE30 or SAE10W-30 SAE10W-40
0°C to 25°C	SAE20 or SAE10W-30 SAE10W-40
below 0°C	SAE10W or SAE10W-30 SAE10W-40

E.5 Coolant

Use a mixture of water and antifreeze. The antifreeze needs to be suitable for aluminium. The antifreeze concentration must be regularly checked in the interests of safety.

Fischer Panda recommend to use the product: GLYSANTIN PROTECT PLUS/G 48.

Engine coolant automotive industry Product description		
Product name	GLYSANTIN ® PROTECT PLUS / G48	
Chemical nature	Monoethylenglycol with inhibitors	
Physical form	Liquid	
Chemical and physical properties		
Reserve alkalinity of 10ml	ASTM D 1121	13 – 15 ml HCl 01 mol/l
Density, 20°C	DIN 51 757 procedure 4	1,121 – 1,123 g/cm ³
Water content	DIN 51 777 part 1	max. 3,5 %
pH-value undiluted		7,1 – 7,3

Coolant mixture ratio	
Water/antifreeze	Temperature
70:30	-20°C
65:35	-25°C
60:40	-30°C
55:45	-35°C
50:50	-40°C

F. Generator Data

F.1 Generator Data

Tabelle 1: Technical data

Type	Kubota V 1505
Govenor	mechanical + VCS
Cylinder	4
Bore	78 mm
Stroke	78,4 mm
Stroke volume	1498 ccm
Cont. power (SAE J1349) at 3000rpm	21,6 kW
Maximum bare speed	3200 rpm
Idle running speed ^a	1500 rpm
Valve clearance (engine cold)	0,145 - 0,185 mm
Cylinder head nut torque	63,7 - 68,6 Nm
Compression ratio	23:1
Lubrication oil capacity	6,0 l
Fuel consumption ^b	approx. 1,1 - 2,9 l
Output voltage	240V 1 phase
Output current	51A
Frequency	50Hz
Coil	Da= 300mm Di= 190mm
Rotor	Lfe= 150mm
Coil resistance	Z-N: approx. 0,19 Ohm L1-N: approx. 0,28 Ohm
Coil inductance	Z-N: approx. 1,45 mH L1-N: approx. 2,44 mH
Stator coil voltage L-N	~3-6 Volt

a. progressive speed by VCS

b. 0,35l/kW electrical power, the randomized values between 30% and 80% of the rated speed



F.2 Capsule measurements

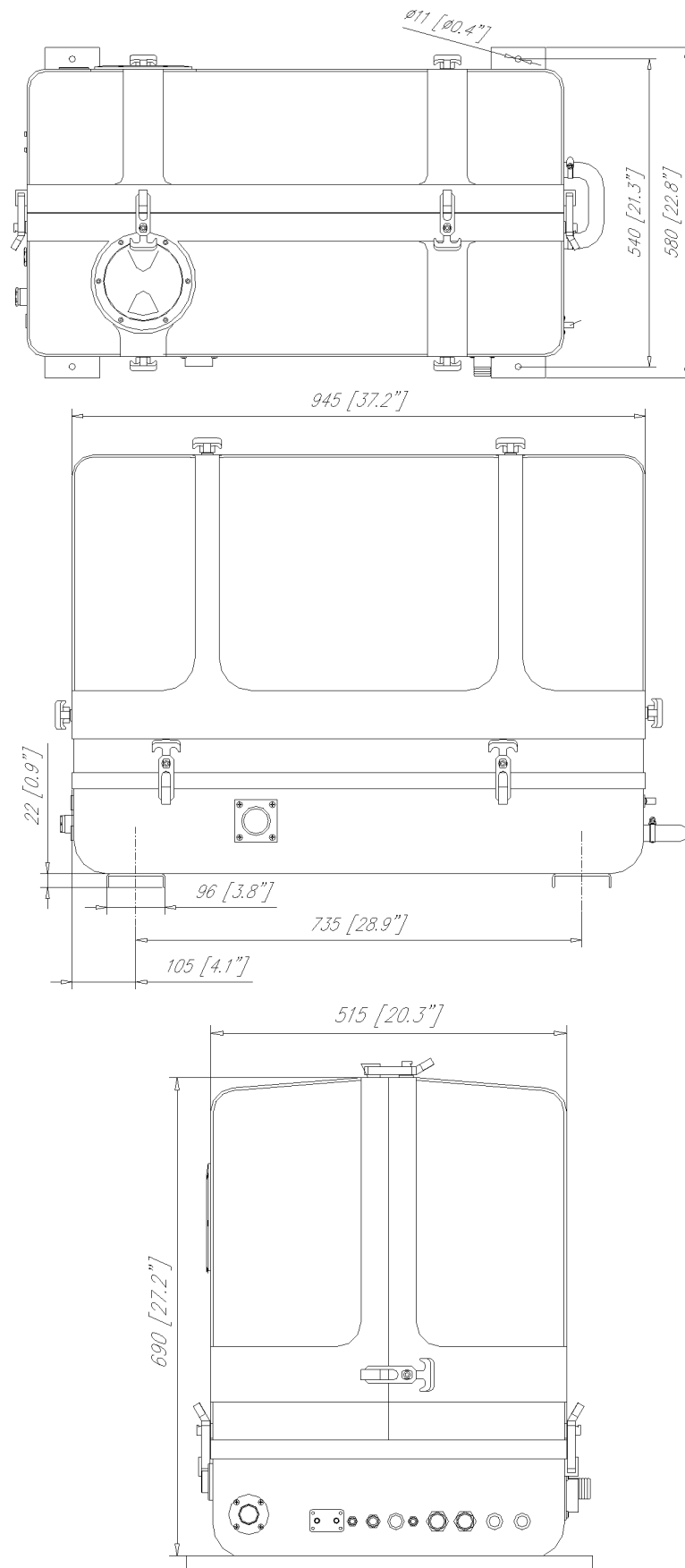



Fischer Panda



8.7.08

Panel Generator Control P6+ RE0703_Kunde_eng.R02

Generator Control Panel P6+ Manual

12V version - 21.02.02.009H

24V special version - 21.02.02.012H

Option automatic adapter - 21.02.02.016H

Option master-slave adapter - 21.02.02.015H

Fischer Panda GmbH

Current revision status

	Document
Actual:	Panel Generator Control P6+ RE0703_Kunde_eng.R02_8.7.08
Replace:	Panel Generator Control P6+ RE0703_Kunde_eng.R01_28.11.07

Revision	Page
Upgrade the whole manual	



ATTENTION!: Please read the safety instructions in your generator manual!

A. General operation

A.1 Panel Generator Control

Fischer Panda Art. No. 21.02.02.009H

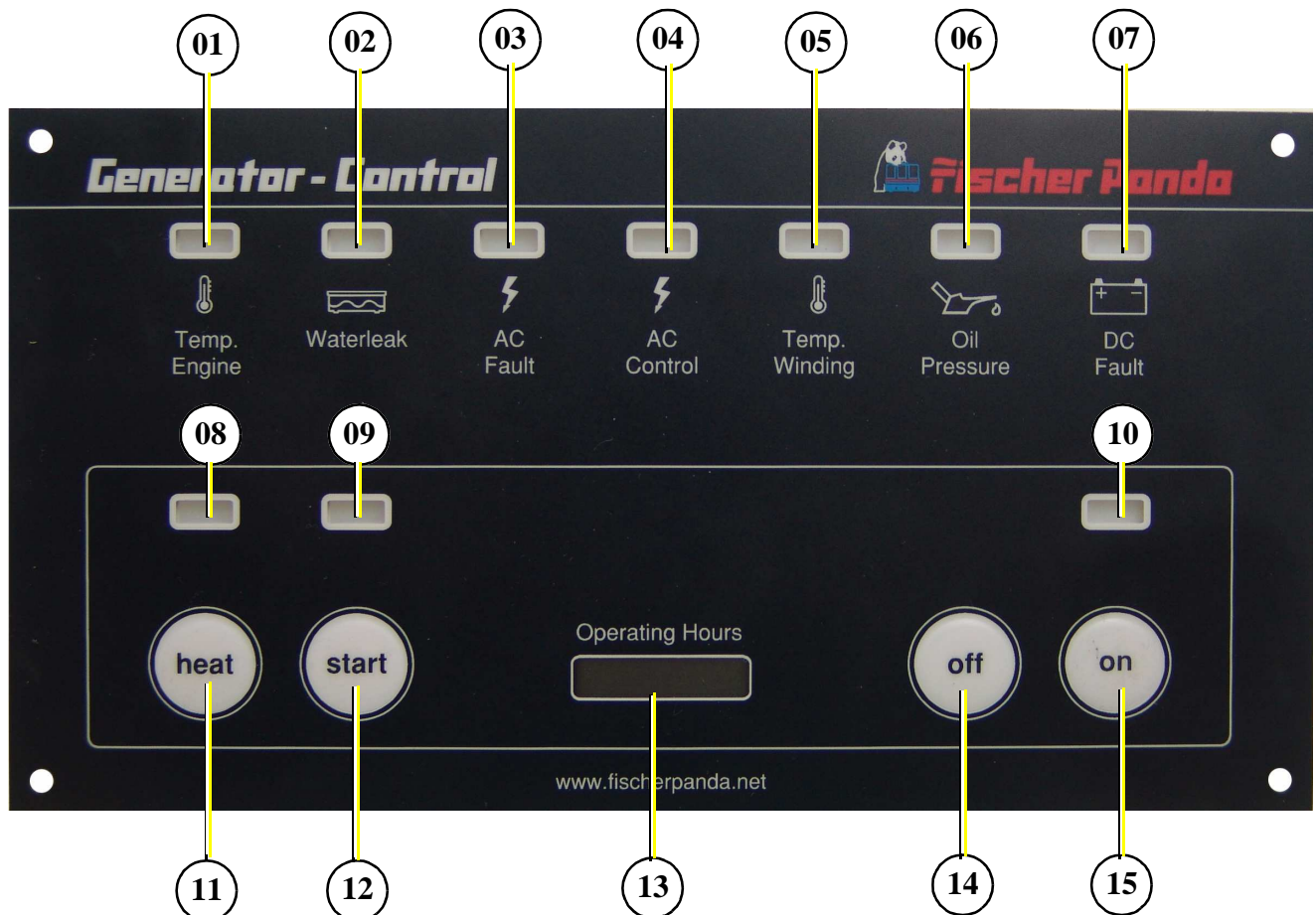

- 01. LED for coolant temperature red¹
- 02. LED for waterleak red/yellow¹ (sensor optional)
- 03. LED for AC-voltage fault red/yellow¹
- 04. LED for AC-voltage ok green¹
- 05. LED for winding temperature red¹
- 06. LED for oil pressure red¹
- 07. LED for battery charge voltage fault green/red¹

- 08. LED for pre-glow „heat“ orange¹
- 09. LED for Generator „start“ green¹
- 10. LED for Generator „stand-by“ green¹
- 11. Push button for pre-glow „heat“
- 12. Push button for Generator „start“
- 13. Operating hours counter
- 14. Push button panel „off“
- 15. Push button panel „on“

¹ LED green: normal operation mode, LED red: fault, LED yellow: warning, LED orange: active

Fig. A.1-1: Panel front

A.2 Rear view 12V-version

Fischer Panda Art. No. 21.02.02.009H

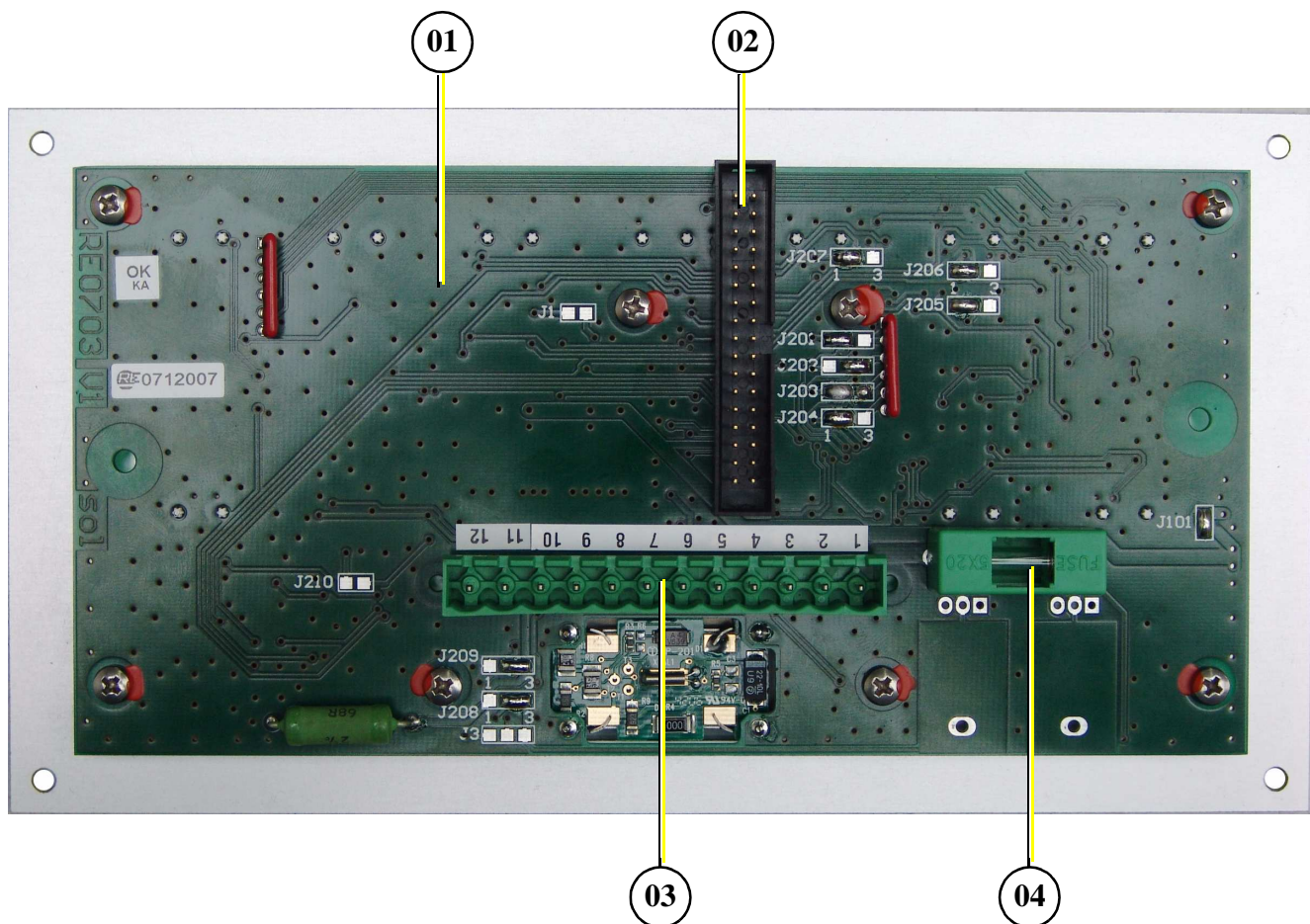

- 01. Control board
- 02. Terminal block (master-slave adapter: left row; automatic adapter: right row)
- 03. Terminals 1-12 (see section A.3.1, "Terminal connections," on page 128)
- 04. Fuse 630mA slow-blow

Fig. A.2-1: Panel rear view 12V-version

A.3 Rear view 24V-version

Fischer Panda Art. No. 21.02.02.012H

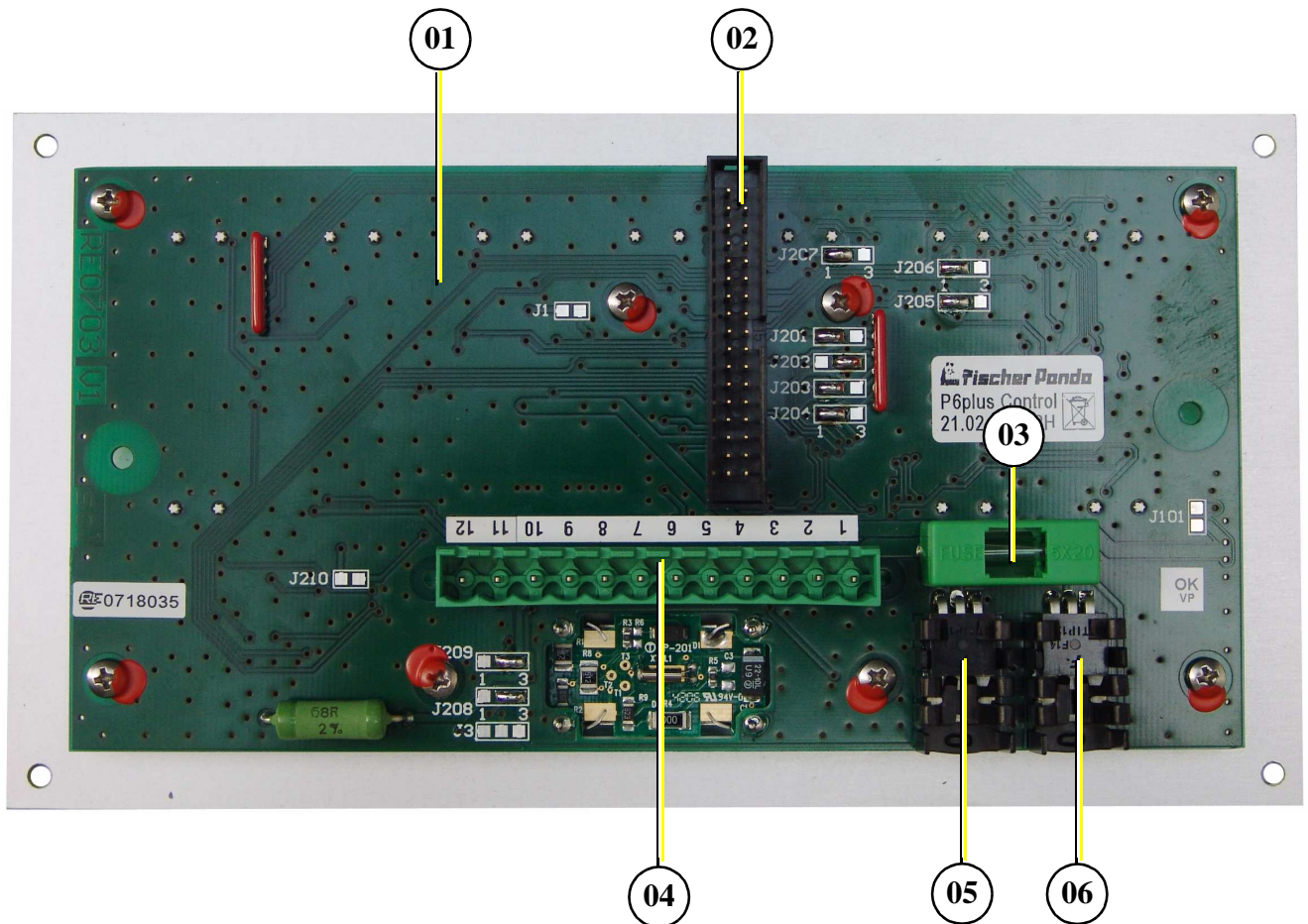

- 01. Control board
- 02. Terminal block (master-slave adapter: left row; automatic adapter: right row)
- 03. Fuse 630mA slow-blow
- 04. Terminals 1-12 (see section A.3.1, "Terminal connections," on page 128)
- 05. Linear controller 24V
- 06. Linear controller 24V

Fig. A.3-1: Panel rear view 24V-version

A.3.1 Terminal connections

Standard for NC temperature switch configured i.e. in case of failure „open“.

Clamp no.	Clamp name	IN / OUT	Description
1	Vbat	IN	Current supply + 12V (or optional 24V, must be adjusted by jumper)
2	GND	IN	Current supply -
3	T-Engine	IN	Error "coolant temperature". Input for thermo-switch to GND. The input is adjustable for NC/NO (N = no error) (must be adjusted by solder Jumper). The input loads the switch with $\geq 22\text{mA}$ to +12V (with 24V-operated internally generated). The occurrence of an error is delayed, for analysis and displayed, around 100ms. Omission not. The in/out status is indicated with red LED.
4	Water leak (Replace air filter)	IN	Error "water leak". Input for sensor switch to GND. The input is adjustable for NC/NO (N = no error) (must be adjusted by solder Jumper). The input loads the switch with $\geq 10\text{mA}$ to +12V (with 24V-operated internally generated). The occurrence of an error is delayed, for analysis and displayed, around 100ms. Omission not. The input status is indicated with red LED. The input can be used alternatively for the signal "Replace air filter" (must be adjusted by solder Jumper). Then the signal does not lead to switching off and is indicated with yellow LED.
5	Oil-Press	IN	Error "oil pressure". Input for oil pressure switches to GND. The input is adjustable for NC/NO (N = no error) (must be adjusted by solder Jumper). The input loads the switch with $\geq 22\text{mA}$ to +12V (with 24V-operated internally generated). The occurrence of an error is delayed, for analysis and displayed, around 1s. Omission not. The input status is indicated with red LED.
6	DC-Control	IN / OUT	Load control display. Input for signal of the dynamo. The input is adjustable for GND = OK or 12V/24V = OK (must be adjusted by solder Jumper). The input loads the signal with 5mA at 12V and 10mA at 24V. The input status is indicated with red and green LED. The connection can supply an energizing current for the dynamo over a fixed resistor with 68R. Either with the control panel switched on or with "Fuel pump" switched on (must be adjusted by solder Jumper). This function is available only in 12V-operation.
7	AC-Control	IN	AC control display. Input for NC-open-collector-sensor-switch to GND (N = OK). The input loads the switch with $\geq 2,5\text{mA}$ to +12V (with 24V-operated internally generated). The input status is indicated with red and green LED's.
8	Heat	OUT	Output for pre-glow relays. The output is so long active, as the button "Heat" is pressed. The output supplies, if active, the voltage of clamp 1. Additionally the output can be operated via the button "start" (must be adjusted by solder Jumper). Consider (notes 1-4).
9	Fuel-Pump	OUT	Output for fuel pump relay. The output is active, if no error is present (inputs 3, 4, 5, 11 and 12, if configured accordingly). The button "start" suppresses the error analysis and the output is then also active in the case of error, if the button "start" is pressed. The output supplies, if active, the voltage of clamp 1. Consider (notes 1-4).
10	Start	OUT	Output for starting relay. The output is active, as long as the button "start" is pressed. The output supplies, if active, the voltage of clamp 1. Consider (notes 1-4).
11	AC-Fault (Fuel Level) [former T-Oil]	IN	Error generator AC input for NC-open-collector-sensor-switch to GND (N = no error). The input loads the switch with $\geq 2,5\text{mA}$ to +12V. (with 24V-operated internally generated). The occurrence of an error is delayed, for analysis and displayed, around 100ms. Omission not. The input status is indicated with red LED. The input can be used alternatively for the signal "Fuel level" (must be adjusted by solder Jumper). The signal does not lead to switching off and is indicated with yellow LED. The input can be used alternatively for the signal "error oil-temperature". The input is adjustable for NC/NO (N = no error) (must be adjusted by solder Jumper). The load of the sensor switch is adjustable to $\geq 10\text{mA}$ by +12V (must be adjusted by solder Jumper).
12	T-Winding	IN	Error "winding temperature". Input for thermo-switch to GND. The input is adjustable for NC/NO (N = no error) (must be adjusted by solder Jumper). The input loads the switch with $\geq 22\text{mA}$ to +12V (with 24V-operated internally generated). The occurrence of an error is delayed, for analysis and displayed, around 100ms. Omission not. The input status is indicated with red LED.

Fig. A.3.1-1: Terminal connections

Notes:

1. Power rating of the output: max. 0,5A in continuous operation and briefly 1,0A.
2. The supply of all output currents may not exceed (less 0,2A power consumption) the rated current of the safety device of the control panel.
3. The output has a free wheeling diode, which short circuits negative voltages (related to GND).
4. The output has a Z-diode, which prevents a supply of positive voltage (related to GND) into the output.

A.3.2 Function of the jumpers

Jumper	Status	Description
J1	closed	during operation of the start button heat is along-operated
	open	Function deactivated
J3	1-2	Dynamo excitation resistor 68R is switched on with Fuel-Pump (1)
	2-3	Dynamo excitation resistor 68R is switched on with Panel-ON (1)
	open	Dynamo excitation resistor is deactivated
J101	closed	12V - operation
	open	24V - operation (optional)
J201	1-2	T-Engine-input, for contact, which opens in case of error (2)
	2-3	T-Engine-input, for contact, which closes in case of error (2)
J202	1-2	Water leak-input / Replace air filter, for contact, which opens in case of error (2)
	2-3	Water leak-input / Replace air filter, for contact, which closes in case of error (2)
J203	1-2	Oil-Press-input, for contact, which opens in case of error (2)
	2-3	Oil-Press-input, for contact, which closes in case of error (2)
J204	1-2	AC-Fault-input / Fuel level, for contact, which opens in case of error (2)
	2-3	AC-Fault-input / Fuel level, for contact, which closes in case of error (2)
J205	1-2	T-Winding-input, for contact, which opens in case of error (2)
	2-3	T-Winding-input, for contact, which closes in case of error (2)
J206	1-2	Input Water leak has red LED and switches off
	2-3	Input Water leak has yellow LED and does not switch off
J207	1-2	Input AC-Fault has red LED and switches off
	2-3	Input AC-Fault has yellow LED and does not switch off
J208	1-2	DC-Control-Signal (-) = OK alternator
	2-3	DC-Control-Signal (+) = OK three-phase alternator
J209	1-2	DC-Control-Signal (-) = OK alternator
	2-3	DC-Control-Signal (+) = OK three-phase alternator
J210	closed	Input AC-Fault has Pull-Up-current $\geq 10\text{mA}$
	open	Input AC-Fault has Pull-Up-current $\geq 2,5\text{mA}$

Fig. A.3.2-1: Function of the solder jumper

The solder jumpers are marked on the printed circuit board (with jumper no. and at three-part solder jumper with soldering surface no.)

(1): Equivalent resistance for load control lamp e.g. for use with three-phase alternator also integrated automatic controller of Bosch. The resistance value is 68Ω 3W, i.e. only for 12V.

(2): A closed contact switches the appropriate input to GND.

A.3.3 Configuration and adjustment

Configuration and setting sheet KE01

Standard jumpering for generators with three-phase alternator.

Panel only for 12V-operation.

The safety device is installed with the value 0,63AT.

The circuit parts for 24V-operation are not equipped.

Jumper	Status	Conf.	Description
J1	closed		during operation of the start button heat is along-operated
	open	X	Function deactivated
J3	1-2		Dynamo excitation resistor 68R is switched on with Fuel-Pump (1)
	2-3		Dynamo excitation resistor 68R is switched on with Panel-ON (1)
	open	X	Dynamo excitation resistor is deactivated
J101	closed	X	12V - operation
	open		24V - operation (not possible)
J201	1-2	X	T-Engine-input, for contact, which opens in case of error (2)
	2-3		T-Engine-input, for contact, which closes in case of error (2)
J202	1-2		Water leak-input / Replace air filter, for contact, which opens in case of error (2)
	2-3	X	Water leak-input / Replace air filter, for contact, which closes in case of error (2)
J203	1-2	X	Oil-Press-input, for contact, which opens in case of error (2)
	2-3		Oil-Press-input, for contact, which closes in case of error (2)
J204	1-2	X	AC-Fault-input / Fuel level, for contact, which opens in case of error (2)
	2-3		AC-Fault-input / Fuel level, for contact, which closes in case of error (2)
J205	1-2	X	T-Winding-input, for contact, which opens in case of error (2)
	2-3		T-Winding-input, for contact, which closes in case of error (2)
J206	1-2	X	Input Water leak has red LED and switches off
	2-3		Input Water leak has yellow LED and does not switch off
J207	1-2	X	Input AC-Fault has red LED and switches off
	2-3		Input AC-Fault has yellow LED and does not switch off

Fig. A.3.3-1: Settings of soldered jumper for this configuration (column Conf.)

J208	1-2		DC-Control-Signal (-) = OK alternator
	2-3	X	DC-Control-Signal (+) = OK three-phase alternator
J209	1-2		DC-Control-Signal (-) = OK alternator
	2-3	X	DC-Control-Signal (+) = OK three-phase alternator
J210	closed		Input AC-Fault has Pull-Up-current $\geq 10\text{mA}$
	open	X	Input AC-Fault has Pull-Up-current $\geq 2,5\text{mA}$

Fig. A.3.3-1: Settings of soldered jumper for this configuration (column Conf.)

The solder jumpers are marked on the printed circuit board (with jumper no. and at three-part solder jumper with soldering surface no.)

(1): Equivalent resistance for load control lamp e.g. for use with three-phase alternator also integrated automatic controller of Bosch. The resistance value is 68Ω 3W, i.e. only for 12V.

(2): A closed contact switches the appropriate input to GND.

Configuration and setting sheet KE02

Standard jumpering for generators with three-phase alternator.

Panel for 24V-operation (over attitude of solder jumper J101 alternatively 12V-operation is possible).

The safety device is installed with the value 0,63AT.

The circuit parts for 24V-operation are not equipped.

Jumper	Status	Conf.	Description
J1	closed		during operation of the start button heat is along-operated
	open	X	Function deactivated
J3	1-2		Dynamo excitation resistor 68R is switched on with Fuel-Pump (1)
	2-3		Dynamo excitation resistor 68R is switched on with Panel-ON (1)
	open	X	Dynamo excitation resistor is deactivated
J101	closed		12V - operation
	open	X	24V - operation
J201	1-2	X	T-Engine-input, for contact, which opens in case of error (2)
	2-3		T-Engine-input, for contact, which closes in case of error (2)
J202	1-2		Water leak-input / Replace air filter, for contact, which opens in case of error (2)
	2-3	X	Water leak-input / Replace air filter, for contact, which closes in case of error (2)
J203	1-2	X	Oil-Press-input, for contact, which opens in case of error (2)
	2-3		Oil-Press-input, for contact, which closes in case of error (2)
J204	1-2	X	AC-Fault-input / Fuel level, for contact, which opens in case of error (2)
	2-3		AC-Fault-input / Fuel level, for contact, which closes in case of error (2)
J205	1-2	X	T-Winding-input, for contact, which opens in case of error (2)
	2-3		T-Winding-input, for contact, which closes in case of error (2)

Fig. A.3.3-2: Einstellung der Lötjumper für diese Konfiguration (Spalte Konf.)

J206	1-2	X	Input Water leak has red LED and switches off
	2-3		Input Water leak has yellow LED and does not switch off
J207	1-2	X	Input AC-Fault has red LED and switches off
	2-3		Input AC-Fault has yellow LED and does not switch off
J208	1-2		DC-Control-Signal (-) = OK alternator
	2-3	X	DC-Control-Signal (+) = OK three-phase alternator
J209	1-2		DC-Control-Signal (-) = OK alternator
	2-3	X	DC-Control-Signal (+) = OK three-phase alternator
J210	closed		Input AC-Fault has Pull-Up-current $\geq 10\text{mA}$
	open	X	Input AC-Fault has Pull-Up-current $\geq 2,5\text{mA}$

Fig. A.3.3-2: Einstellung der Lötjumper für diese Konfiguration (Spalte Konf.)

The solder jumpers are marked on the printed circuit board (with jumper no. and at three-part solder jumper with soldering surface no.)

(1): Equivalent resistance for load control lamp e.g. for use with three-phase alternator also integrated automatic controller of Bosch. The resistance value is 68Ω 3W, i.e. only for 12V.

(2): A closed contact switches the appropriate input to GND.

Configuration and setting sheet KE03

Standard jumpering for generators with alternator.

Panel only for 12V-operation.

The safety device is installed with the value 0,63AT.

The circuit parts for 24V-operation are not equipped.

Jumper	Status	Konf.	Description
J1	closed		during operation of the start button heat is along-operated
	open	X	Function deactivated
J3	1-2		Dynamo excitation resistor 68R is switched on with Fuel-Pump (1)
	2-3		Dynamo excitation resistor 68R is switched on with Panel-ON (1)
	open	X	Dynamo excitation resistor is deactivated
J101	closed	X	12V - operation
	open		24V - operation (not possible)
J201	1-2	X	T-Engine-input, for contact, which opens in case of error (2)
	2-3		T-Engine-input, for contact, which closes in case of error (2)
J202	1-2		Water leak-input / Replace air filter, for contact, which opens in case of error (2)
	2-3	X	Water leak-input / Replace air filter, for contact, which closes in case of error (2)
J203	1-2	X	Oil-Press-input, for contact, which opens in case of error (2)
	2-3		Oil-Press-input, for contact, which closes in case of error (2)

Fig. A.3.3-3: Einstellung der Lötjumper für diese Konfiguration (Spalte Konf.)

J204	1-2	X	AC-Fault-input / Fuel level, for contact, which opens in case of error (2)
	2-3		AC-Fault-input / Fuel level, for contact, which closes in case of error (2)
J205	1-2	X	T-Winding-input, for contact, which opens in case of error (2)
	2-3		T-Winding-input, for contact, which closes in case of error (2)
J206	1-2	X	Input Water leak has red LED and switches off
	2-3		Input Water leak has yellow LED and does not switch off
J207	1-2	X	Input AC-Fault has red LED and switches off
	2-3		Input AC-Fault has yellow LED and does not switch off
J208	1-2	X	DC-Control-Signal (-) = OK alternator
	2-3		DC-Control-Signal (+) = OK three-phase alternator
J209	1-2	X	DC-Control-Signal (-) = OK alternator
	2-3		DC-Control-Signal (+) = OK three-phase alternator
J210	closed		Input AC-Fault has Pull-Up-current $\geq 10\text{mA}$
	open	X	Input AC-Fault has Pull-Up-current $\geq 2,5\text{mA}$

Fig. A.3.3-3: Einstellung der Lötjumper für diese Konfiguration (Spalte Konf.)

The solder jumpers are marked on the printed circuit board (with jumper no. and at three-part solder jumper with soldering surface no.)

(1): Equivalent resistance for load control lamp e.g. for use with three-phase alternator also integrated automatic controller of Bosch. The resistance value is 68Ω 3W, i.e. only for 12V.

(2): A closed contact switches the appropriate input to GND.

Configuration and setting sheet KE04

Standard jumpering for generators with alternator.

Panel for 24V-operation (over attitude of solder jumper J101 alternatively 12V-operation is possible).

The safety device is installed with the value 0,63AT.

The circuit parts for 24V-operation are not equipped.

Jumper	Status	Konf.	Description
J1	closed		during operation of the start button heat is along-operated
	closed	X	Function deactivated
J3	1-2		Dynamo excitation resistor 68R is switched on with Fuel-Pump (1)
	2-3		Dynamo excitation resistor 68R is switched on with Panel-ON (1)
	closed	X	Dynamo excitation resistor is deactivated
J101	closed		12V - operation
	closed	X	24V - operation
J201	1-2	X	T-Engine-input, for contact, which opens in case of error (2)
	2-3		T-Engine-input, for contact, which closes in case of error (2)

Fig. A.3.3-4: Einstellung der Lötjumper für diese Konfiguration (Spalte Konf.)

J202	1-2		Water leak-input / Replace air filter, for contact, which opens in case of error (2)
	2-3	X	Water leak-input / Replace air filter, for contact, which closes in case of error (2)
J203	1-2	X	Oil-Press-input, for contact, which opens in case of error (2)
	2-3		Oil-Press-input, for contact, which closes in case of error (2)
J204	1-2	X	AC-Fault-input / Fuel level, for contact, which opens in case of error (2)
	2-3		AC-Fault-input / Fuel level, for contact, which closes in case of error (2)
J205	1-2	X	T-Winding-input, for contact, which opens in case of error (2)
	2-3		T-Winding-input, for contact, which closes in case of error (2)
J206	1-2	X	Input Water leak has red LED and switches off
	2-3		Input Water leak has yellow LED and does not switch off
J207	1-2	X	Input AC-Fault has red LED and switches off
	2-3		Input AC-Fault has yellow LED and does not switch off
J208	1-2	X	DC-Control-Signal (-) = OK alternator
	2-3		DC-Control-Signal (+) = OK three-phase alternator
J209	1-2	X	DC-Control-Signal (-) = OK alternator
	2-3		DC-Control-Signal (+) = OK three-phase alternator
J210	closed		Input AC-Fault has Pull-Up-current $\geq 10\text{mA}$
	open	X	Input AC-Fault has Pull-Up-current $\geq 2,5\text{mA}$

Fig. A.3.3-4: Einstellung der Lötjumper für diese Konfiguration (Spalte Konf.)

The solder jumpers are marked on the printed circuit board (with jumper no. and at three-part solder jumper with soldering surface no.)

(1): Equivalent resistance for load control lamp e.g. for use with three-phase alternator also integrated automatic controller of Bosch. The resistance value is 68Ω 3W, i.e. only for 12V.

(2): A closed contact switches the appropriate input to GND.



A.4 Starting preparation / Checks (daily)

A.4.1 Marine version

1. Oil level control (ideal level: 2/3 MAX).

The level should be about 2/3 of the maximum level of a cold engine.

Further, if installed, the oil level of the oil-cooled bearing must be controlled before each start - see sediment bowl at generator front cover!.

2. State of cooling water.

The external expansion tank should be filled up to 1/3 of the maximum in a cold state. It is very important that a large expansion area remains above the cooling water level.

3. Check if sea cock for cooling water intake is open.

For safety reasons, the sea cock must be closed after the generator has been switched off. It should be re-opened before starting the generator.

4. Check raw water filter.

The raw water filter must be regularly checked and cleaned. The impeller fatigue increases, if residual affects the raw water intake.

5. Visual inspection.

Control fixing bolts, check hose connectors for leakages, control electrical connections.

6. Switch off the load.

The generator should only be started without load.

7. Open fuel valve, if installed.

8. Close battery main switch (switch on).

A.4.2 Vehicle version

1. Oil level control (ideal level: 2/3 MAX).

The level should be about 2/3 of the maximum level of a cold engine.

Further, if installed, the oil level of the oil-cooled bearing must be controlled before each start - see sediment bowl at generator front cover!.

2. State of cooling water.

The external expansion tank should be filled up to 1/3 of the maximum in a cold state. It is very important that a large expansion area remains above the cooling water level.

3. Visual inspection.

Control fixing bolts, check hose connectors for leakages, control electrical connections.

4. Switch off the load.

The generator should only be started without load.

5. Open fuel valve, if installed.

6. Close battery main switch (switch on).

A.5 Starting and stopping the generators

A.5.1 Starting the generator

1. Press button „on“ (switch on).

LED for "on" = green.



2. Press button „heat“ (preglow engine).

LED for "heat" = orange.

Depending upon engine type and execution pre-heating can be necessary. Pre-heat is necessary at an operating temperature <20°C.



A.5.1 Starting the generator

3. Press button „start“ (start engine).

LED for "start" = green.

The electric starter may only be used for a maximum of 20 seconds. Thereafter, a pause of at least, 60 seconds is required. If the genset does not immediately start, then the fuel intake should be checked to ensure it is flowing freely. (For temperatures below -8°C check whether there is winter fuel)



4. Switch on load.

The load should only be switched on if the generator voltage is within the permissible range. Parallel connection of several loads should be avoided, especially if there are loads with electric motors, such as air-conditioning units in the system. In this case, the load must be connected Step by Step.

A.5.2 Stopping the generator

1. Switch off load.

2. Recommendation: With turbo engines and during load more than highly 70% of the rated output, stabilize generator temperature at least 5 minutes with load switched off.

At higher ambient temperatures (more than 25°C) the generator should always run for at least 5 minutes without load, before it is switched off, regardless of the load.

3. Press button „off“ (switch off).

LED for "on" = off.



NOTE: Never switch off the battery until the generator has stopped, if necessary close fuel valve!



A.6 Automatic adapter - option

Fischer Panda Art. No. 21.02.02.016H

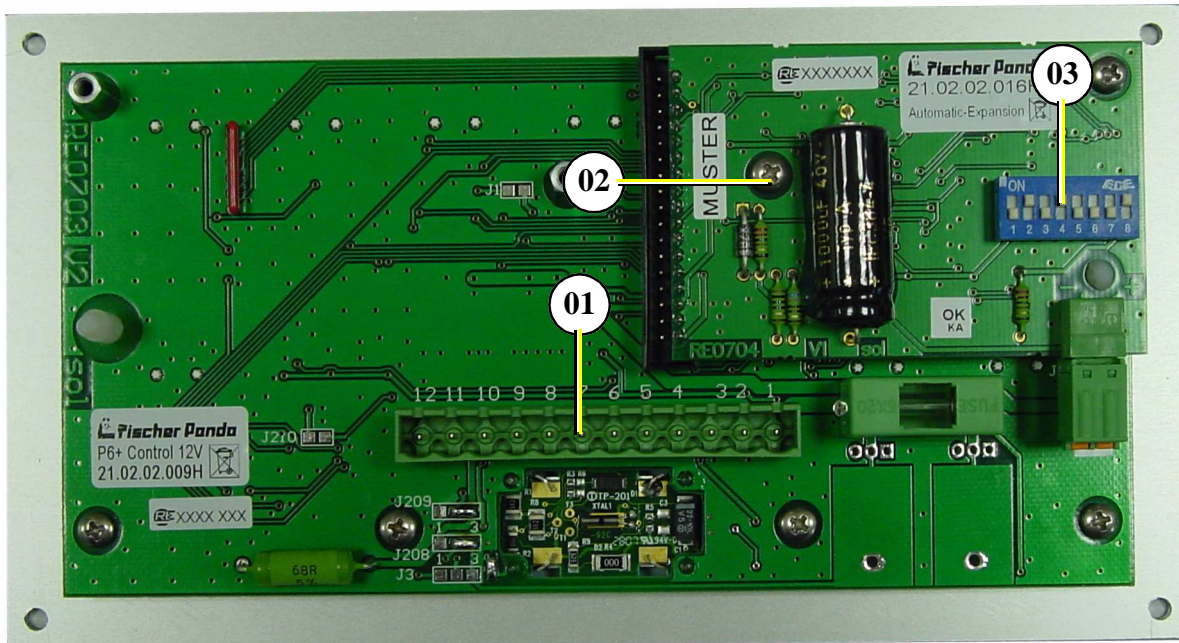

- 01. Main terminals
- 02. Automatic adapter 21.02.02.016H
- 03. 8-pole DIP-switch

Fig. A.6-1: Panel 21.02.02.009H with Automatic adapter 21.02.02.016H

Function:

The automatic adapter RE0704 extends the generator control panel P6+ with an automatic input. A potential-free contact can be attached to this input. If this contact is closed, then the generator, which is attached to the generator control panel P6+, is started automatically. If the contact is opened, then the generator is stopped automatically.

The automatic starting procedure consists of pre-heating (heat) and operating the starter (start). It can be again aborted at any time by opening the contact at the automatic input.

For automatic stopping (stop) the output "Fuel pump" (clamp 9 generator control panel) is switched off. The time for the automatic stop procedure can be terminated only by switching off generator control panel prematurely.

The times for "heat", "start" and "stop" are separately adjustable (see below).

The additional automatic adapter switched on and off using the generator control panel with its push buttons "on" and "off".

If the contact at the automatic input is connected, while the generator control panel is switched on, then the automatic starting procedure is carried out.

If the current supply is attached or switched on using the generator control panel, while the contact of the automatic input is closed, then the automatic starting procedure won't be carried out, because the generator control panel is always switched off after attaching the current supply (generator the control panel must have been separate from the current supply for at least 60s).

The mechanism entrance:

With (-) characterized connection is connected to GND.

With (+) characterized connection is the input.

The input is connected through a resistance to 12V (with 24V-operated internally generated). If the two connections are short circuited over a potential-free contact, then the input current flows.

To be considered for an electronic contact the low input current and the polarity is to be selected.

The high input current is to be selected for an electromechanical contact.

The input is debounced (delay time approx.1s).

On the input an external voltages must not be set.

Data:	
Parameter	Information
Operation voltage	The automatic adapter power is supplied via the generator control panel P6+. The same absolute maximum ratings obtain as with the generator control panel P6+.
Operation temperature	The same absolute maximum ratings obtain as with the generator control panel P6+.
Proper power consumption	10mA - 20mA
Tolerance of times	± 10%

8-pole DIP-switch S1 settings (S1.1 to S1.8):										
		standard	S1.1	S1.2	S1.3	S1.4	S1.5	S1.6	S1.7	S1.8
Heat-time	2,5s		OFF	OFF						
	5s		ON	OFF						
	10s	X	OFF	ON						
	20s		ON	ON						
Start-time	8s	X			OFF					
	16s				ON					
Stop-time	16s					OFF	OFF			
	32s	X				ON	OFF			
	64s					OFF	ON			
	128s					ON	ON			
Operation-mode	Normal	X						OFF		
	Test (all times over 16)							ON		
Input current	1,25mA									OFF
	7mA	X								ON

Fig. A.6-2: Settings

Attention:

The automatic adapter must only be used together with a device. The starter should only be switched on when the generator stationary (shut-down)!



A.6.1 Terminal connections

Connection for the automatic adapter X2 (row with odd pin numbers // I/O viwe from operating panel)

Pin-no.	Pin-name	I / O	Description
1	VBF	O	Current supply + (operation voltage behind fuse)
3	GND	O	Current supply - (ground)
5	VBFS	O	Current supply + switched (voltage Pin 1, with panel switched on)
7	12V	O	Current supply + switched, at 12V-operation over closed soldered jumper J101 connected with VBFS (at optional 24V-operation: VBFS over internal voltage regulator at 12,9V regulated)
9	GND	O	Current supply - (ground)
11	GND	O	Current supply - (ground)
13	/Heat-signal	I	Heat is active, if the input is switched to GND
15	/Start-signal	I	Start is active, if the input is switched to GND
17	GND	O	Current supply - (ground)
19	GND	O	Current supply - (ground)
21	GND	O	Current supply - (ground)
23	GND	O	Current supply - (ground)
25	GND	O	Current supply - (ground)
27	/Stop-signal	I	The Fuel pump signal is switched off, as long as the input is switched to GND, (also when starting)
29	FP-Int	O	Fuel pump signal internally, decoupled over diode from external signal
31	/Fault-signal	O	Output is switched to GND, if an error is present (inputs 3, 4, 5, 11 and 12, if configured and generally for 2s, after switching on the panel)
33	GND	O	Current supply - (ground)

Fig. A.6.1-1: Terminal connections automatic adapter



A.7 Master-Slave adapter - option

Fischer Panda Art. No. 21.02.02.015H 12V-version

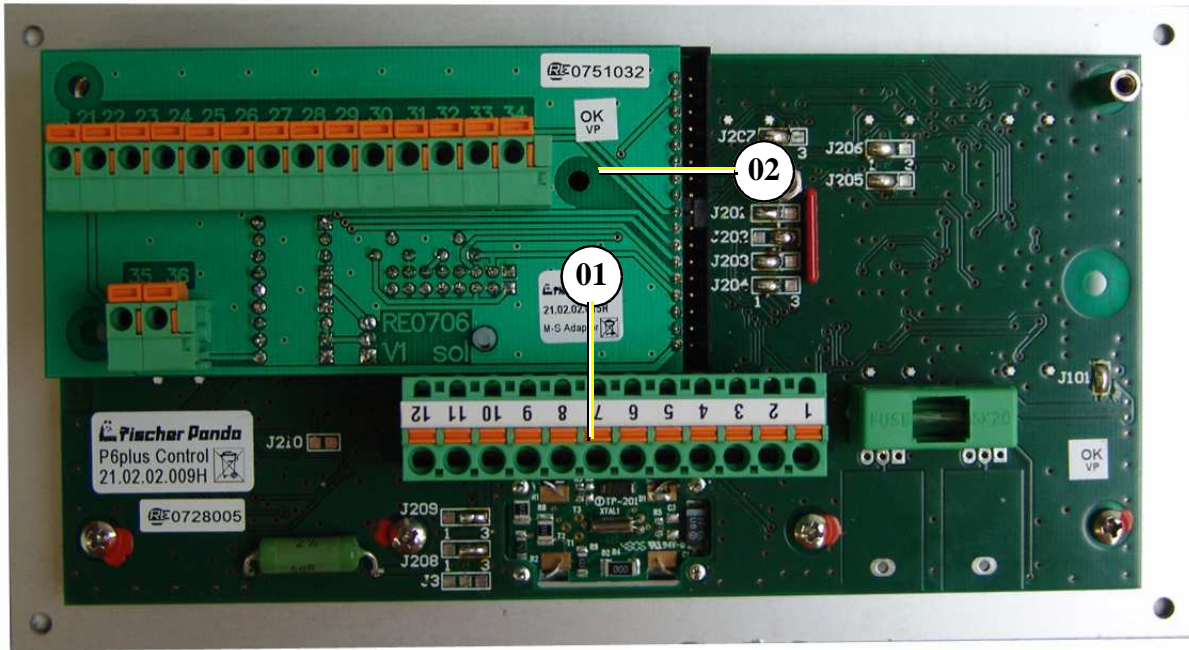

- 01. Main terminals
- 02. Master-slave adapter 21.02.02.015H

Fig. A.7-1: Panel 21.02.02.009H with master-slave adapter 21.02.02.015H

Fischer Panda Art. No. 21.02.02.01H 24V-version

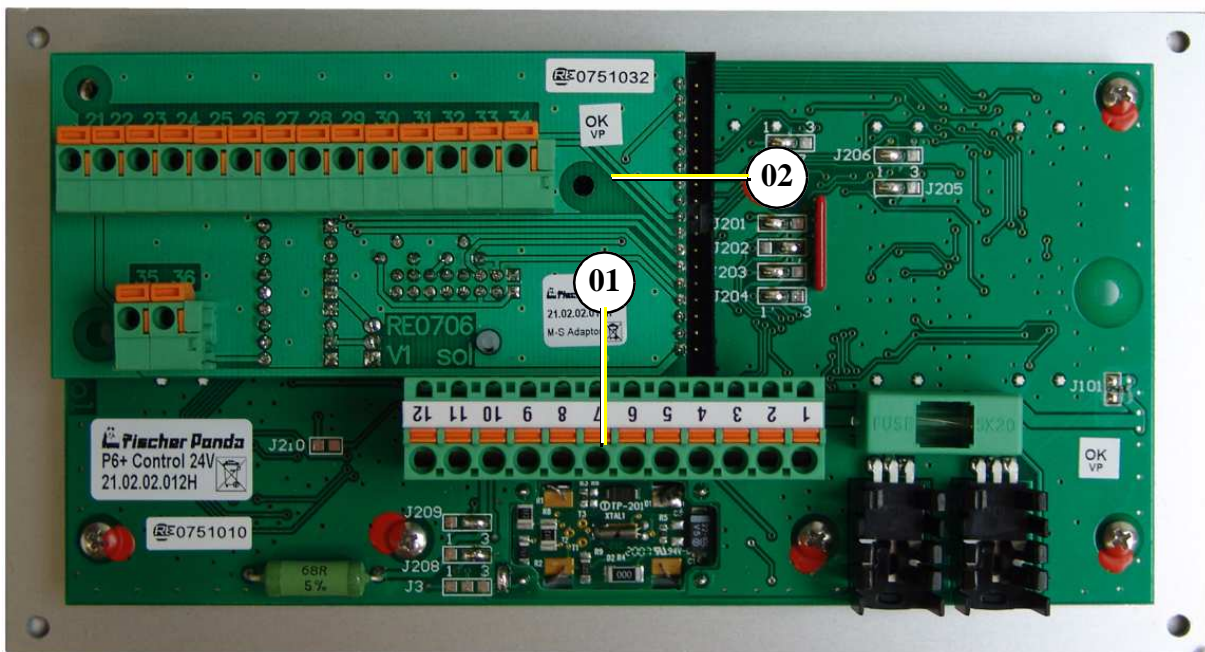

- 01. Main terminals
- 02. Master-slave adapter 21.02.02.015H

Fig. A.7-2: Panel 21.02.02.012H with master-slave adapter 21.02.02.015H

With the Master-Slave-Adapter RE0706 two Generator Control Panels P6+ RE0703 can be connected to a Master-Slave-Combination. In addition on each Generator Control Panel P6+ an Master-Slave-Adapter RE0706 is installed. The Generator Control Panel P6+ is interconnected by the 14pole connecting terminals on the Master-Slave-Adapters 1:1. The Master-Panel is hereby defined when the generator is connected to the main connector. Thus, the main connector of the Slave-Panel should not be occupied (unconnected).

The solder jumpers on the Master-Panel have to be coded in the same manner as for a Master-Panel without a Slave-Panel as in normal operation. The solder jumpers on the Slave-Panel are coded as for slave operation (please see the appropriate adjustment pages for the Generator Control Panel P6+ RE0703).

The Master-Panel and Slave-Panel are identical, and only differs as a result of the coding. Both Master-Slave-Panels are also identical.

Terminal Connections:

X2: (14polig, 21 - 34) master Slave connection (1:1 wire)

X3: (2polig, 35 - 36) 35: Panel on signal of the Generator Control Panel P6+ RE0703

36: Error signal of the Generator Control Panel P6+ RE0703

The Panel-ON-Signal is active when the panel is switched on.

The error signal is so long active, as the panel recognizes an error, which must lead to switching the generator off.

The output voltage corresponds to the operating voltage of the Generator Control Panel P6+ less 0,7V - 1,4V. Each output has a free wheeling diode which short circuits externals voltage supplies under 0V and a decoupling diode which decouples the circuitry from external power feeding.

Fuse:

A 0,8AT fuse must be installed on the Master-Panel.

A.7.1 Terminal connections

Terminal X2 (IN/OUT from view Master-Opearating-Panel)

Pin-No.	Pin-name	IN / OUT	Description
21	VBF	O	Current supply + (operation voltage behind fuse 12Vdc or 24Vdc depending on system)
22	GND	O	Current supply - (ground)
23	ON-Signal	I / O	Panels are switched on, if the connection is switched using a push button (on master or slave) to VBF
24	OFF-Signal	I / O	Panels are switched off, if the connection is switched using a push button (on master or slave) to VBF
25	/Heat-Signal	I / O	Heat is active, if the connection is switched over a push button (on master or Slave) to GND
26	/Start-Signal	I / O	Start is active, if the connection is switched over a push button (on master or Slave) to GND
27	LED-T-Engine	O	Output for LED T-Engine on the Slave panel, is switched to GND, if the LED is illuminated
28	LED-Water-leak (Replace Airfilter)	O	Output for LED Waterleak on the Slave panel, is switched to GND, if the LED is illuminated
29	LED-Oil-Press	O	Output for LED Oil-Press on the Slave panel, is switched to GND, if the LED is illuminated
30	LED-AC-Fault (Fuel Level)	O	Output for LED AC-Fault on the Slave panel, is switched to GND, if the LED is illuminated

Fig. A.7.1-1: Terminal connections terminal X2 (IN/OUT from the view of the master-control-panel)

31	LED-T-Winding	O	Output for LED T-Winding on the Slave panel, is switched to GND, if the LED is illuminated
32	DC-Control	O	Output for LED DC-Control-display on the Slave panel. The DC control signal is ground through 1:1.
33	AC-Control		Output for LED AC-Control-display on the Slave panel. The AC control signal is ground through 1:1.
34	VBFS	O	Current supply + switched (otherwise like 21, VBF)

Fig. A.7.1-1: Terminal connections terminal X2 (IN/OUT from the view of the master-control-panel)

The use of these connections for other purposes, other than the master-slave connection of two generator control panels, is generally forbidden. In individual cases, after consultation and clarifying the technical details, a release for another use can, if technically possible, be allowed.

Terminal X3

Pin-No.	Pin-name	IN / OUT	Description
35	Panel ON	O	With panel (ON/OFF) switched voltage of clamp X2.1 (VBF). (Consider notes 1-4)
36	Error	O	Output is switched on, if a ceitical error is present. (Consider notes 1-4)

Fig. A.7.1-2: Terminal connections terminal X3

Notes:

1. Power rating of the output: max. 0,5A in continuous operation and briefly 1,0A.
2. The supply of all output currents may not exceed (less 0,2A power consumption) the rated current of the safety device of the control panel.
3. The output has a free wheeling diode, which short circuit negative voltages (related to GND).
4. The output has a Z-diode, which prevents an overvoltage (related to GND) into the output.

A.7.2 Configuration and adjustment

Configuration and setting sheet KE05

Standard Jumperung for use as Slave-Panel in connection with **two** Master-Slave-Adapters RE0706 and a Generator Control Panel P6+ RE0703 as Master-Panel. Panel only for 12V-Betrieb.

The safety device is installed with the value 0,63AT.

The circuit parts for 24V-operation are not equipped.

Jumper	Status	Conf.	Description
J1	closed		during operation of the start button heat is along-operated
	open	XM	Function deactivated
J3	1-2		Dynamo excitation resistor 68R is switched on with Fuel-Pump (1)
	2-3		Dynamo excitation resistor 68R is switched on with Panel-ON (1)
	open	XM	Dynamo excitation resistor is deactivated
J101	closed	M	12V - operation
	open	M	24V - operation (not possible)
J201	1-2		T-Engine-input, for contact, which opens in case of error (2)
	2-3	XM	T-Engine-input, for contact, which closes in case of error (2)
J202	1-2		Water leak-input / Replace air filter, for contact, which opens in case of error (2)
	2-3	XM	Water leak-input / Replace air filter, for contact, which closes in case of error (2)
J203	1-2		Oil-Press-input, for contact, which opens in case of error (2)
	2-3	XM	Oil-Press-input, for contact, which closes in case of error (2)
J204	1-2		AC-Fault-input / Fuel level, for contact, which opens in case of error (2)
	2-3	XM	AC-Fault-input / Fuel level, for contact, which closes in case of error (2)
J205	1-2		T-Winding-input, for contact, which opens in case of error (2)
	2-3	XM	T-Winding-input, for contact, which closes in case of error (2)
J206	1-2	M	Input Water leak has red LED and switches off
	2-3	M	Input Water leak has yellow LED and does not switch off
J207	1-2	M	Input AC-Fault has red LED and switches off
	2-3	M	Input AC-Fault has yellow LED and does not switch off
J208	1-2	M	DC-Control-Signal (-) = OK alternator
	2-3	M	DC-Control-Signal (+) = OK three-phase alternator
J209	1-2	M	DC-Control-Signal (-) = OK alternator
	2-3	M	DC-Control-Signal (+) = OK three-phase alternator
J210	closed		Input AC-Fault has Pull-Up-current $\geq 10\text{mA}$
	open	XM	Input AC-Fault has Pull-Up-current $\geq 2,5\text{mA}$

Fig. A.7-1: Settings of soldered jumper for this configuration (column Conf.)

The solder jumpers are marked on the printed circuit board (with jumper no. and at three-part solder jumper with soldering surface no.)

X = Jumper must be so set

XM = Jumper, function must be so set on the master panel is selected

M = Jumper must be set exactly the same, as on the master panel,

(1): Equivalent resistance for load control lamp e.g. for use with three-phase alternator also integrated automatic controller of Bosch. The resistance value is 68Ω 3W, i.e. only for 12V.

(2): A closed contact switches the appropriate input to GND.

Configuration and setting sheet KE06

Standard jumpering for use as Slave-Panel in connection with **two** Maste-Slave-Adapters RE0706 and a Generator Control Panel P6+ RE0703 as Master-Panel. Panel for 24V-operation. (over attitude of solder jumper J101 alternatively 12V-operation is possible)

The safety device is installed with the value 0,63AT.

The circuit parts for 24V-operation are not equipped.

Jumper	Status	Conf.	Description
J1	closed		during operation of the start button heat is along-operated
	open	XM	Function deactivated
J3	1-2		Dynamo excitation resistor 68R is switched on with Fuel-Pump (1)
	2-3		Dynamo excitation resistor 68R is switched on with Panel-ON (1)
	open	XM	Dynamo excitation resistor is deactivated
J101	closed	M	12V - operation
	open	M	24V - operation
J201	1-2		T-Engine-input, for contact, which opens in case of error (2)
	2-3	XM	T-Engine-input, for contact, which closes in case of error (2)
J202	1-2		Water leak-input / Replace air filter, for contact, which opens in case of error (2)
	2-3	XM	Water leak-input / Replace air filter, for contact, which closes in case of error (2)
J203	1-2		Oil-Press-input, for contact, which opens in case of error (2)
	2-3	XM	Oil-Press-input, for contact, which closes in case of error (2)
J204	1-2		AC-Fault-input / Fuel level, for contact, which opens in case of error (2)
	2-3	XM	AC-Fault-input / Fuel level, for contact, which closes in case of error (2)
J205	1-2		T-Winding-input, for contact, which opens in case of error (2)
	2-3	XM	T-Winding-input, for contact, which closes in case of error (2)
J206	1-2	M	Input Water leak has red LED and switches off
	2-3	M	Input Water leak has yellow LED and does not switch off
J207	1-2	M	Input AC-Fault has red LED and switches off
	2-3	M	Input AC-Fault has yellow LED and does not switch off
J208	1-2	M	DC-Control-Signal (-) = OK alternator
	2-3	M	DC-Control-Signal (+) = OK three-phase alternator
J209	1-2	M	DC-Control-Signal (-) = OK alternator
	2-3	M	DC-Control-Signal (+) = OK three-phase alternator
J210	closed		Input AC-Fault has Pull-Up-current $\geq 10\text{mA}$
	open	XM	Input AC-Fault has Pull-Up-current $\geq 2,5\text{mA}$

Fig. A.7-2: Settings of soldered jumper for this configuration (column Conf.)

The solder jumpers are marked on the printed circuit board (with jumper no. and at three-part solder jumper with soldering surface no.)

X = Jumper must be so set

XM = Jumper, function must be so set on the master panel is selected

M = Jumper must be set exactly the same, as on the master panel,

(1): Equivalent resistance for load control lamp e.g. for use with three-phase alternator also integrated automatic controller of Bosch. The resistance value is 68Ω 3W, i.e. only for 12V.

(2): A closed contact switches the appropriate input to GND.



B. Measurements

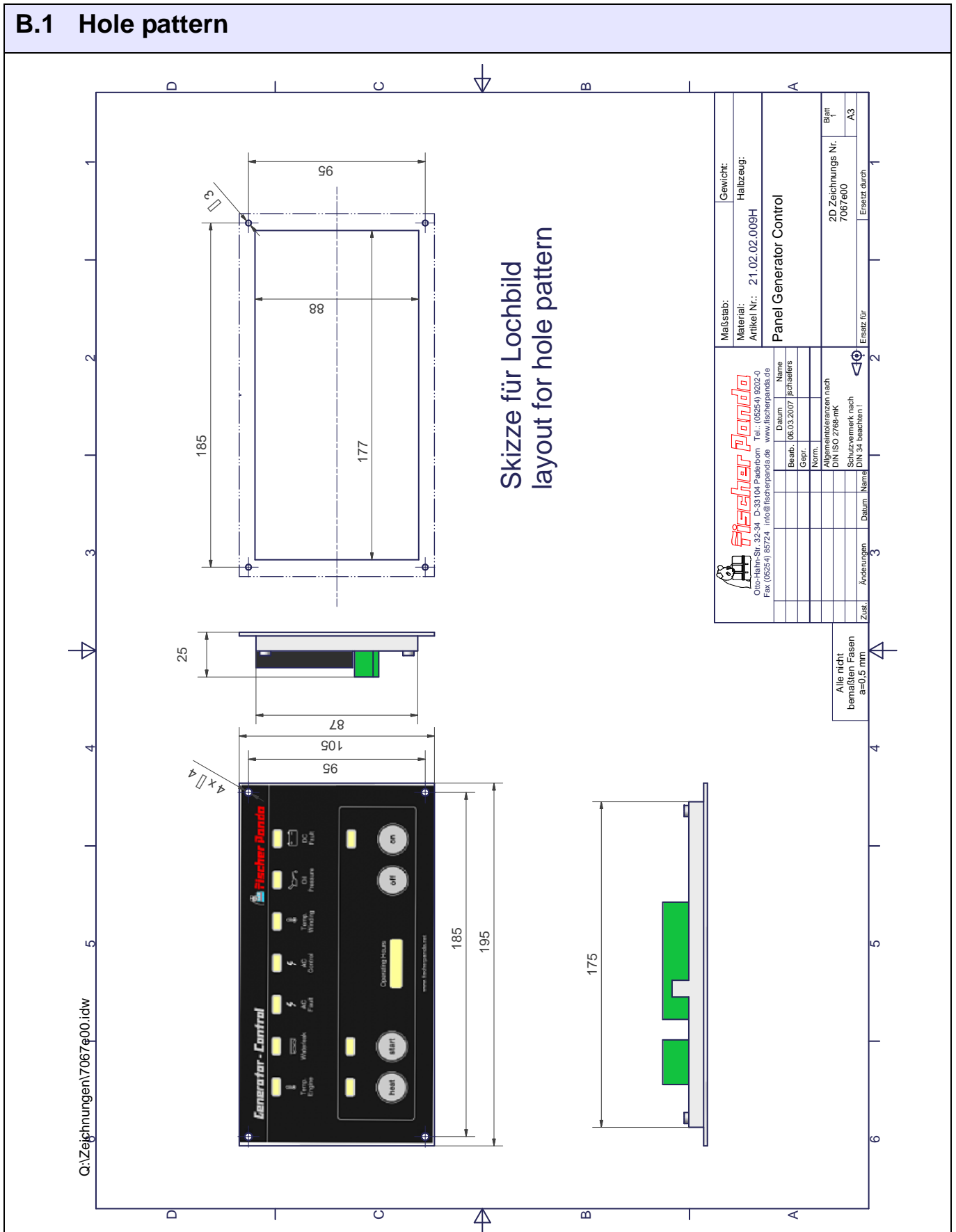

Fig. B.1-1: Hole pattern

Intentionally Blank