

Index

Index	2
Important Notice	4
1. Safety instructions	5
1.1 General	5
1.2 Safety Instructions	6
2. Product description	7
2.1 Preface	7
2.2 Area of application	8
2.3 Hardware	9
2.3.1 Control elements and interfaces	10
2.3.2 Device connections: power and high voltage	13
2.3.3 Device connections: control signals and interfaces	14
3. Operator interface	18
3.1 Control keyboard and signaling	18
3.2 Navigating the menus	19
3.3 Display	21
3.3.1 Field	21
3.3.2 Generator	21
3.3.3 Mains	21
3.3.4 Actual regulation	22
3.3.5 Digital & Analog Inputs/Outputs monitor	22
3.3.6 Fieldbus	23
3.3.7 Alarms	23
3.3.8 Fault log details	23
3.3.9 Exciter	24
4. Configuration	25
4.1 Inputs and outputs	25
4.1.1 Digital inputs	25
4.1.2 Enabling virtual digital inputs	26
4.1.3 Digital outputs	27
4.1.4 Enabling virtual digital outputs	28
4.1.5 Fast De-Excitation output	29
4.1.6 Analog inputs	31
4.1.7 Enabling virtual analog inputs	33
4.1.1 Analog Outputs	34
4.1.1 Enable Virtual Analog Outputs	36
4.1.1 RS485 Communication	37
4.1.1 USB Communication	37
4.1.1 CAN bus communication	37
4.1.1 Ethernet communication	38
4.2 Description and Configuration Parameters	38
4.2.1 Field excitation data	38
4.2.1 Minimum Excitation Current	38
4.2.1 Maximum Excitation Current	39
4.2.2 Generator data	39
4.2.3 Generator current	40
4.2.1 V/Hz limit	40
4.2.2 Soft Start	41
4.2.1 The Limit of Minimum Reactive Power	41
4.2.1 The Limit of Maximum Reactive Power	42
4.2.1 Implementation Limits	42
4.2.2 Sensing	43
4.2.3 Power supply	43
4.2.4 Control mode	43

4.2.5	Droop	44
4.2.6	Series compensation	44
4.2.7	Field flashing	45
4.2.8	Boost	45
4.2.9	New Function Q	46
4.2.10	New Function PF	46
4.2.11	Rotor diode monitor	46
4.2.12	Synchronization (optional)	48
4.2.13	Alarms	49
4.2.14	Limitations	49
4.2.15	Operator interface	49
4.3	Commands	50
4.3.1	Non volatile parameters	50
4.3.2	Self commissioning	50
4.3.3	System test utilities	50
4.3.4	Virtual I/O	50
4.3.5	Alarm	50
4.3.6	Access control	51
5.	Reference and regulators	52
5.1	PWM reference (PWM)	52
5.2	Field voltage reference (FVR)	53
5.3	Field current reference and regulator (FCR)	54
5.4	Generator voltage reference and regulator (AVR)	55
5.5	Generator PF reference and regulator (PF)	56
5.6	Generator VAR reference and regulator (VAR)	57
5.7	Limit regulators	58
6.	Commissioning	59
6.1	Safety regulations	59
6.2	Connection of the Regulator	59
6.2.1	Power Supply	59
6.2.1	Voltage Signals	59
6.3	Setting the Standard Parameters	59
6.4	Operations to be done while the machine is off	60
6.5	Operations to be done while the machine is off	61
7.	Maintenance and Breakdown	62
7.1	Maintenance	62
7.2	Problem Solving	62
8.	General data	64
8.1	S2006 up to 15A	65
8.2	S2006 up to 25A	66
8.3	S2006 up to 40A	67

Important Notice

Our experience has shown that, if the information and recommendations contained in this Operating Instructions are observed, the best possible reliability of our products is assured.

The data contained herein purports solely to describe the product and is not a warranty of performance or characteristics. It is with the best interests of our customers in mind that we constantly strive to improve our products and keep them abreast of advances in technology. This may, however, lead to discrepancies between a product and its "Technical Description" or "Operating Instructions".

This document has been carefully prepared and reviewed, however should in spite of this the reader find an error, he is requested to inform us at his earliest convenience.

It is scarcely possible for the operating instructions for technical equipment to cover every eventuality, which can occur in practice. We would therefore request you to notify us or our agent in the case of all unusual behaviour that does not appear to be covered by these operating instructions.

It is pointed out that all local regulations must be observed when connecting and commissioning this equipment in addition to these operating instructions.

We cannot accept any responsibility for damage incurred as a result of mishandling the equipment regardless of whether particular reference is made in these operating instructions or not.

We lay particular stress on the fact that only genuine spare parts should be used for replacements.

All rights with respect to this document, including applications for patent and registration of other industrial property rights, are reserved. Unauthorized use, in particular reproduction or making available to third parties, is prohibited.

1. SAFETY INSTRUCTIONS

1.1 General

The safety instructions shall be followed during installation, commissioning, operation and maintenance of the excitation system. Read all instructions carefully before operating the device and keep this manual for future reference.

Required Qualification

Personnel involved in installation work and commissioning of the S2006 must be familiar, specially instructed and informed about the residual danger areas according to the regulations currently in force.

Operating personnel is not permitted to work at the control system.

Specially instructed personnel must only carry out maintenance and repair work.





The maintenance personnel must be informed about the emergency shutdown measures and must be capable of turning off the system in case of emergency.

The maintenance personnel must be familiar with the accident prevention measures at their workplace and must be instructed in first aid and fire fighting.

It is the owner's responsibility to ensure that each person involved in the installation and commissioning of the S2006 has received the appropriate training or instructions and has thoroughly read and clearly understood the safety instructions in this chapter.

1.2 Safety Instructions

The safety instructions always appear at the beginning of each chapter and/or precede any instruction in the context where a potentially dangerous situation may appear. The safety instructions are divided into five categories and emphasized by the use of the following layout and safety signs:

 DANGER	DANGER! This symbol indicates an imminent danger resulting from mechanical forces or high voltage. A non-observance leads to life-threatening physical injury or death.
	WARNING! This symbol indicates a dangerous situation. A non-observance may lead to bad or life-threatening physical injury or death.
	IMPORTANT! This symbol indicates useful information. Not to be used to indicate dangerous situations.
	NOTICE! This symbol emphasizes important information. A non-observance may cause damage to the converter or to objects close to it.

2. PRODUCT DESCRIPTION

2.1 Preface

S2006 is an automatic voltage regulator of the latest design for synchronous generators and synchronous motors. The unit contains the most advanced microprocessor technology together with IGBT semiconductor technology (Insulated Gate Bipolar Transistor).

A practical and simple-to-operate panel on the unit is used for all control operations. In addition, user friendly software facilitates commissioning and allows optimization of operation.

The mechanical construction is compact and robust. You can order the regulator in the rack configuration 19".

2.2 Area of application

This advanced-design automatic voltage regulator is used for the excitation of indirectly excited synchronous machines. This unit is only suitable for this one area of application.

The regulator can also be switched over to function as a reactive power-, power factor- or field current regulator.

SM = Synchronous Machine

E = Exciter

PMG = Permanent-Magnet-Generator

Optional:

- Synchronization unit
- Diode monitoring
- Change over to a back-up unit.

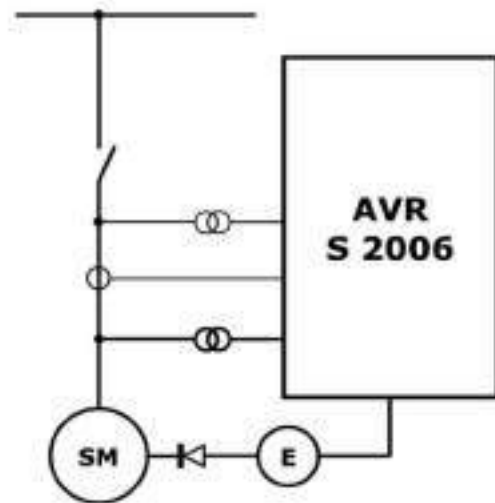

Generator or motor excitation with PMG or external supply.

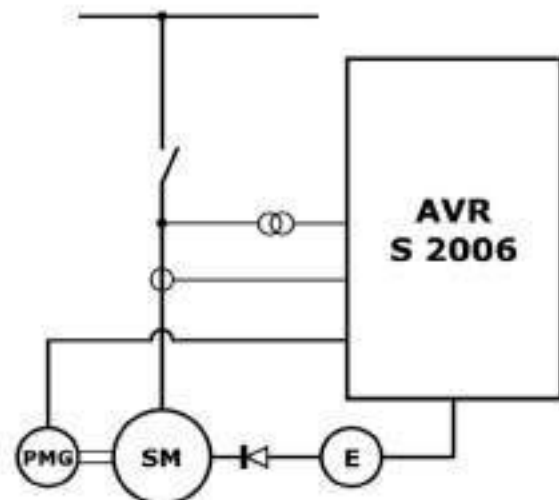

Replacement of voltage regulators for generators or motors with direct-current excitation machines.

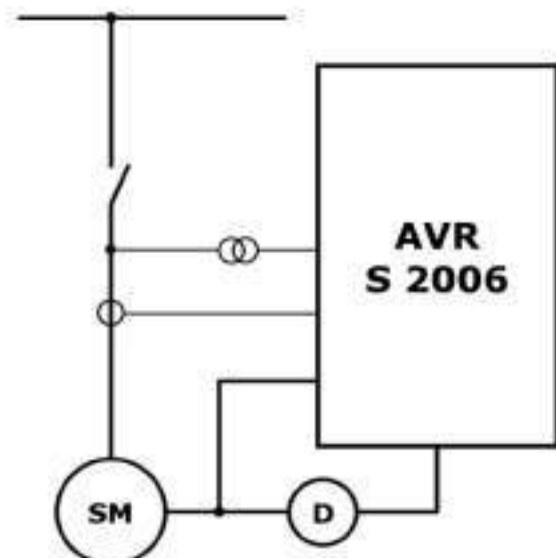

2.3 Hardware

Structure:

The device is built into an aluminum casing with cooling flanges.
The connection terminals are integrated around of the circuit boards.

Power electronics:

The power part is fitted with an IGBT semiconductor.
The average value of the output voltage is always positive.
The output is current limited and short-circuit proof.

Control elements:

The operating keys and the display are located on the unit cover.

Installation:

The site of installation must be dry and free of dust.

Mounting:

The S2006 is designed for wall mounting.
For optimal cooling is to keep free a minimum distance of 100mm all around the unit.

Connection diagram:

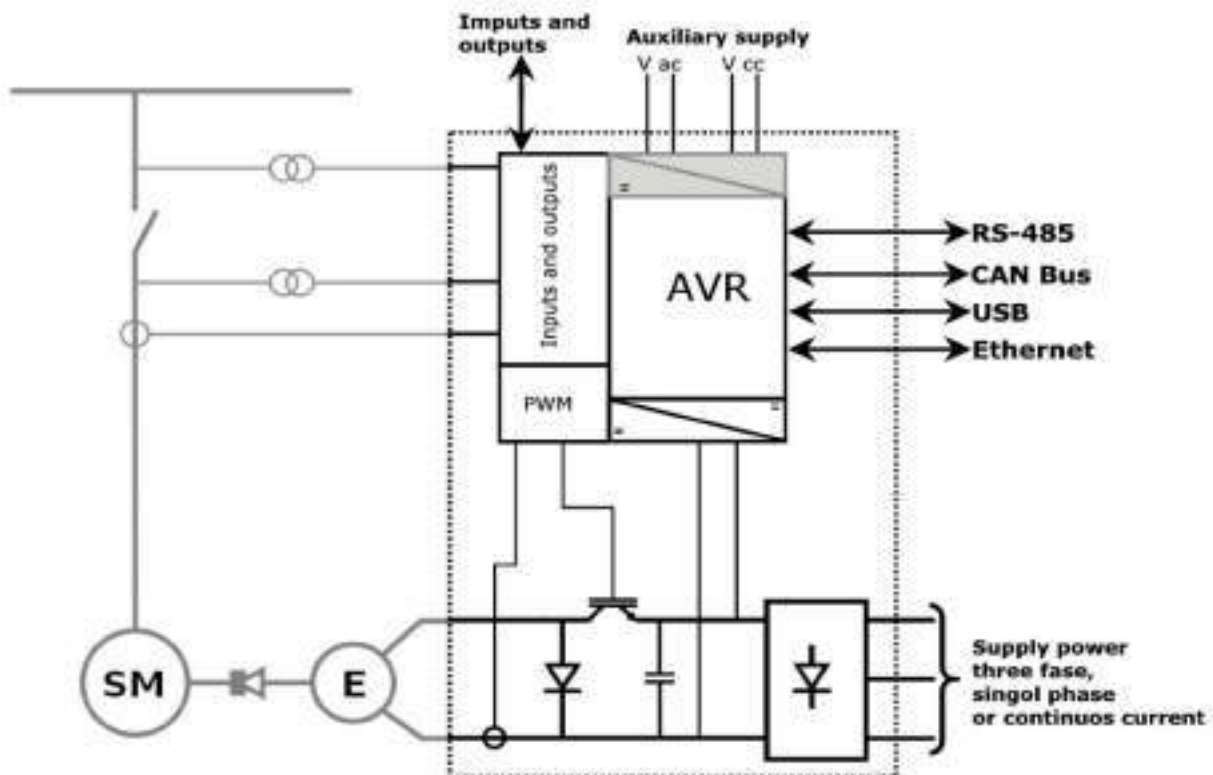

2.3.1 Control elements and interfaces

Carrying out settings on the unit

The display and the four keys are sufficient to allow complete operation.

All settings can be carried out directly on the unit without additional equipment

- Configuration of inputs and outputs
- Parameter setting
- Display of important measuring values.

Interface with PC

Parameter setting and also optimization is possible using the user-friendly software *S2006 Configurator* for Microsoft Windows.

Connection cable, standard USB with A-B connectors

- Configuration of inputs and outputs
- Parameter setting
- Trending function for optimization of the controller (Oscilloscope, Power chart)
- Display of important measuring values
- Parameter File upload or download.

Terminal blocks

Overview of the device connections

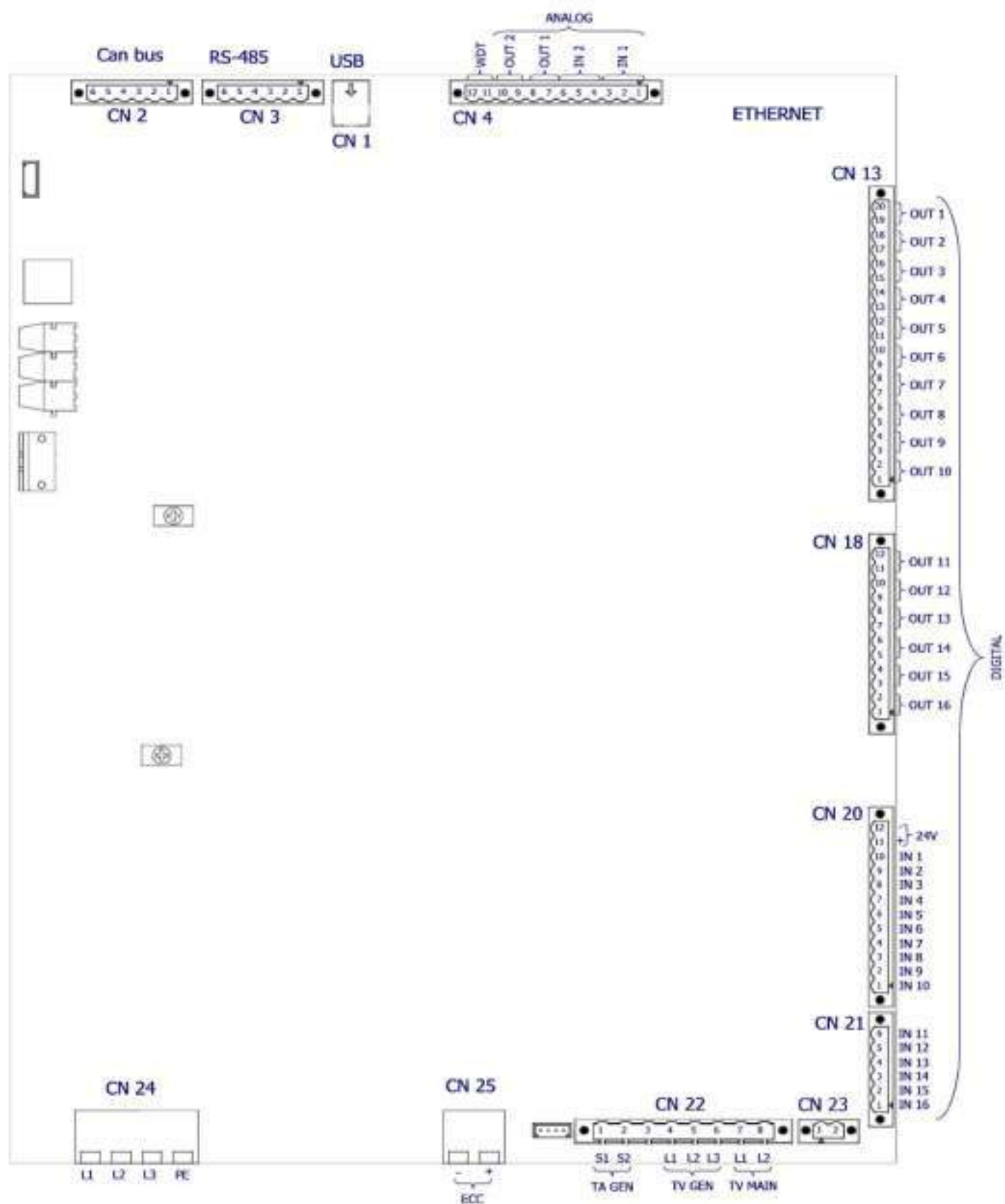

CN1 – Communication USB (type B)

1. V USB
2. D-
3. D+
4. GND USB

CN2 – Communication CANBUS

1. CAN H
2. CAN H
3. CAN L
4. CAN L
5. GND CAN
6. GND CAN

CN3 – Communication RS485

1. Link-
2. Link-
3. Link+
4. Link+
5. GND RS485
6. GND RS485

CN4 – Analogic inputs/outputs

1. Output +10V (eventual potentiometer)
2. Analog input 1 (-20mA++20mA or -10V++10V)
3. Analog input 1 GND
4. Output +10V (eventual potentiometer)
5. Analog input 2 (-20mA++20mA or -10V++10V)
6. Analog input 2 GND
7. Analog output 1 +
8. Analog output 1 GND
9. Analog output 2 +
10. Analog output 2 GND
11. Watch-dog C
12. Watch-dog E

CN13 – Digital outputs

- 1-2. Digital output K10
- 3-4. Digital output K9
- 5-6. Digital output K8
- 7-8. Digital output K7
- 9-10. Digital output K6
- 11-12. Digital output K5
- 13-14. Digital output K4
- 15-16. Digital output K3
- 17-18. Digital output K2
- 19-20. Digital output K1

CN18 – Digital outputs

- 1-2. Digital output K16
- 3-4. Digital output K15
- 5-6. Digital output K14
- 7-8. Digital output K13
- 9-10. Digital output K12
- 11-12. Digital output K11

CN 20 – Digital inputs

1. Digital input 10
2. Digital input 9
3. Digital input 8
4. Digital input 7
5. Digital input 6
6. Digital input 5
7. Digital input 4
8. Digital input 3
9. Digital input 2
10. Digital input 1
11. + 24V (for PNP connection)
12. GND (for NPN connection)

CN 21 – Digital inputs

1. Digital input 16
2. Digital input 15
3. Digital input 14
4. Digital input 13
5. Digital input 12
6. Digital input 11

CN22 – Sensing inputs

1. TA-S1 generator
2. TA-S2 generator
3. nc
4. L1 generator
5. L2 generator
6. L3 generator
7. L1 main
8. L2 main

CN23 – De-energize command

1. +
2. -

CN 24 – Power electronics supply input

1. Phase L1
2. Phase L2
3. Phase L3
4. P.E.

CN 25 – Excitation output

1. Excitation +
2. Excitation -

CN 30 – Auxiliary power supply (optional)

1. L
2. N
3. P.E.
4. P.E.

nc = not connected

2.3.2 Device connections: power and high voltage

Terminal designation	Signal	Specifications
<u>Auxiliary supply (optional)</u>	AC input voltage	20 to 265 Vrms 50+60 Hz
	DC input voltage	20 to 400 Vdc
<u>Power electronics supply</u>	AC input voltage three-phase	Two models are available according to the maximum supply voltage: <ul style="list-style-type: none"> • 265Vrms / 400Vdc • 530Vrms / 800Vdc $V_S = V_{EN} * Ceiling * 0,741$
	AC input voltage single-phase	
	DC input voltage	
<u>Measurements inputs</u>	3 generator voltage	<ul style="list-style-type: none"> • Galvanic isolation • 0+100 or 0+500 Vrms • Automatic range selection
	2 main voltage	
	1 generator current	<ul style="list-style-type: none"> • Galvanic isolation • 0+1 or 0+5 Arms • Automatic range selection
<u>Excitation output</u>	Excitation	<p>0 to Vmax, where Vmax is a function of the input voltage of the power electronics supply:</p> <ul style="list-style-type: none"> • up to 98% of DC supply • up to 90% of rectified AC supply for three-phase • up to 80% of rectified AC supply for single-phase
		<p>Current: (five sizes available)</p> <ul style="list-style-type: none"> • 0 to 5A • 0 to 10A • 0 to 15A • 0 to 25A • 0 to 40A

2.3.3 Device connections: control signals and interfaces

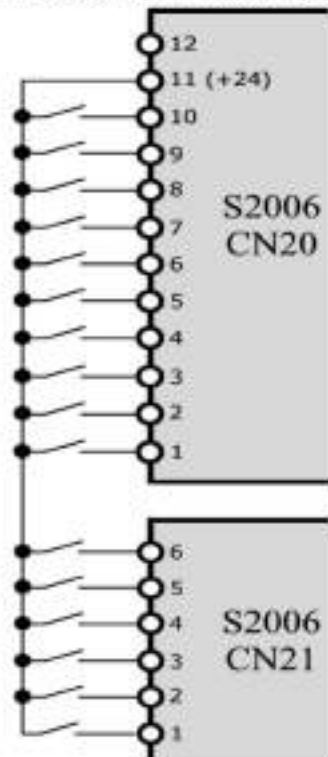
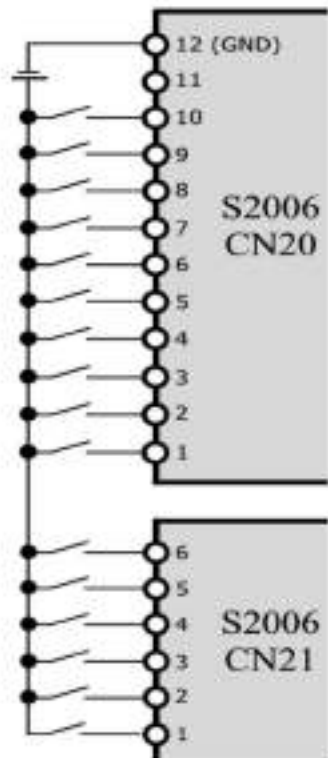
Terminal designation	Signal	Specifications
<p>Digital Inputs</p>	<p>16 digital inputs</p>	<ul style="list-style-type: none"> • Connection with internal supply <div style="text-align: center;">  </div> • connection with external supply <div style="text-align: center;">  </div> • opto-isolated • 12-24V / 2,5mA • programmable function

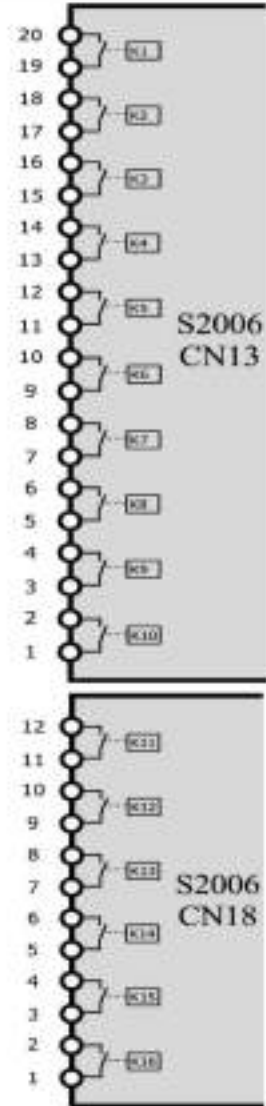
Terminal designation	Signal	Specifications
<u>Digital outputs</u>	16 digital outputs	 <p>The diagram shows two relay modules. The top module, labeled S2006 CN13, has 20 terminals numbered 1 to 20 from bottom to top. Each terminal is connected to a relay contact labeled R1 through R10. The bottom module, labeled S2006 CN18, has 12 terminals numbered 1 to 12 from bottom to top. Each terminal is connected to a relay contact labeled R11 through R18.</p> <ul style="list-style-type: none"> • relay, CO voltage-free contact • 6A @ 250Vac • 6A @ 30Vdc • 0.2A @ 110Vdc • 0.1A @ 220Vdc • programmable function

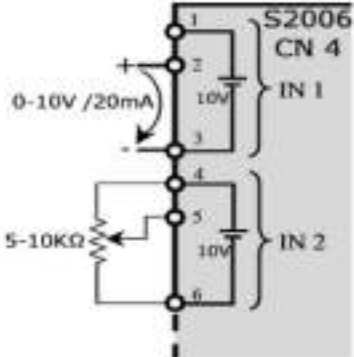
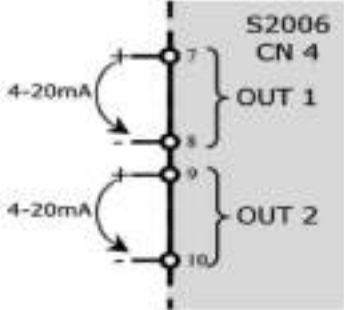
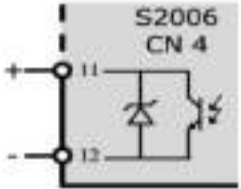
Terminal designation	Signal	Specifications
<u>Analog inputs</u>	2 analog inputs	 <ul style="list-style-type: none"> • opto-isolated • differential input • 0→20mA / -10→10V by software setting • programmable function
<u>Analog output</u>	2 analog outputs	 <ul style="list-style-type: none"> • opto-isolated • 4→20mA • maximum voltage 20V • Load $47\Omega \leq R_c \leq 470\Omega$
<u>Watchdog</u>	1 digital output	 <ul style="list-style-type: none"> • opto-isolated transistor • 1mA @ 24Vdc
<u>Communication</u>	1 USB	<ul style="list-style-type: none"> • opto-isolated • standard type "B" connector • Virtual Com Port driver • Modbus RTU and proprietary protocols

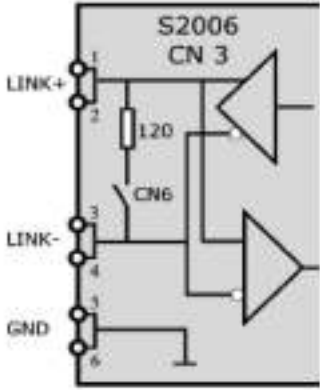
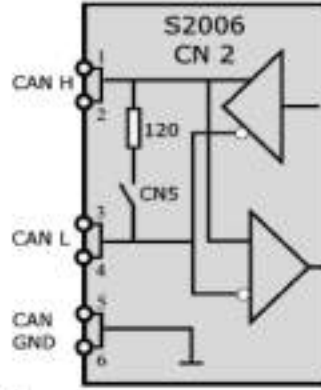
Terminal designation	Signal	Specifications
	1 RS485	 <ul style="list-style-type: none"> • opto-isolated • half duplex • multidrop, max 128 devices • selectable termination • Modbus RTU and proprietary protocols
	1 CAN	 <ul style="list-style-type: none"> • opto-isolated • selectable termination • CAN open and proprietary protocols
	2 Ethernet (optional)	<ul style="list-style-type: none"> • galvanic isolation • standard RJ-45 connectors • full duplex 10/100Base-TX • Modbus/TCP protocol • RSTP protocol for loop-free redundant connection

3. OPERATOR INTERFACE

In this following charter are described the operations of management parameter, using programming keyboard.

3.1 Control keyboard and signaling

The modifications operated on the values of the parameters, also entering in action immediately, are not stored in way automatic, but require a specific action of storage that is obtained by means of the command "C.000" [Save parameters].

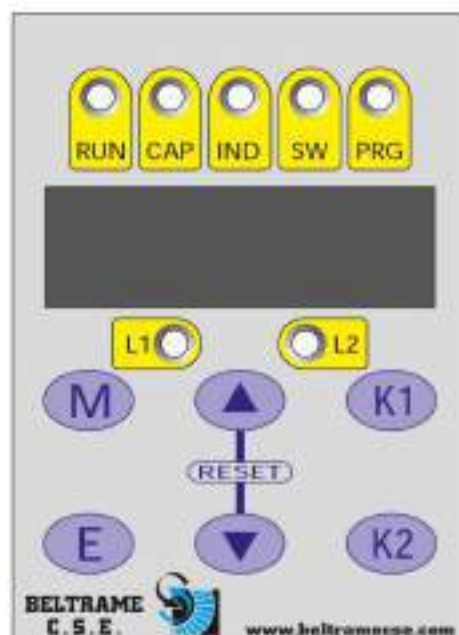

M Scroll menu: Consent change menu' parameter (d.xxx, R.xxx, I.xxx, P.xxx and C.xxx).

E Enter: used to begin setting parameter and/or confirm value;

▲ UP: used to increase displaying parameter and/or numerical value;

▼ DOWN: used to decrease displaying parameter and/or numerical value;

▲ + ▼ UP + DOWN = RESET
pushed both execute manual reset

K1 K1: the function is freely programmable by parameter

K2 K2: the function is freely programmable by parameter

Meaning of LED :

Run (green Led): - led on = The RUN command is enabled and activated
- led fast blinking = The controller is limiting

Ind (green Led): positive reactive power generated

Cap (green Led): negative reactive power generated

SW (red Led):

- led on = Parallel Switch Closed
- led slow blinking = Operation outside the synchronization window
- led fast blinking = Operation within the synchronization window

Prg (yellow Led):

- led on = when not ready to run
- led blinking = when a parameter modification is not saved

L1 (yellow Led): the function is freely programmable by parameter (default = calibrator at minimum)

L2 (yellow Led): the function is freely programmable by parameter (default = calibrator at maximum)

3.2 Navigating the menus

When the S2006 is power on, the display automatically shows parameter d.000 (Field current) in the Display menu.

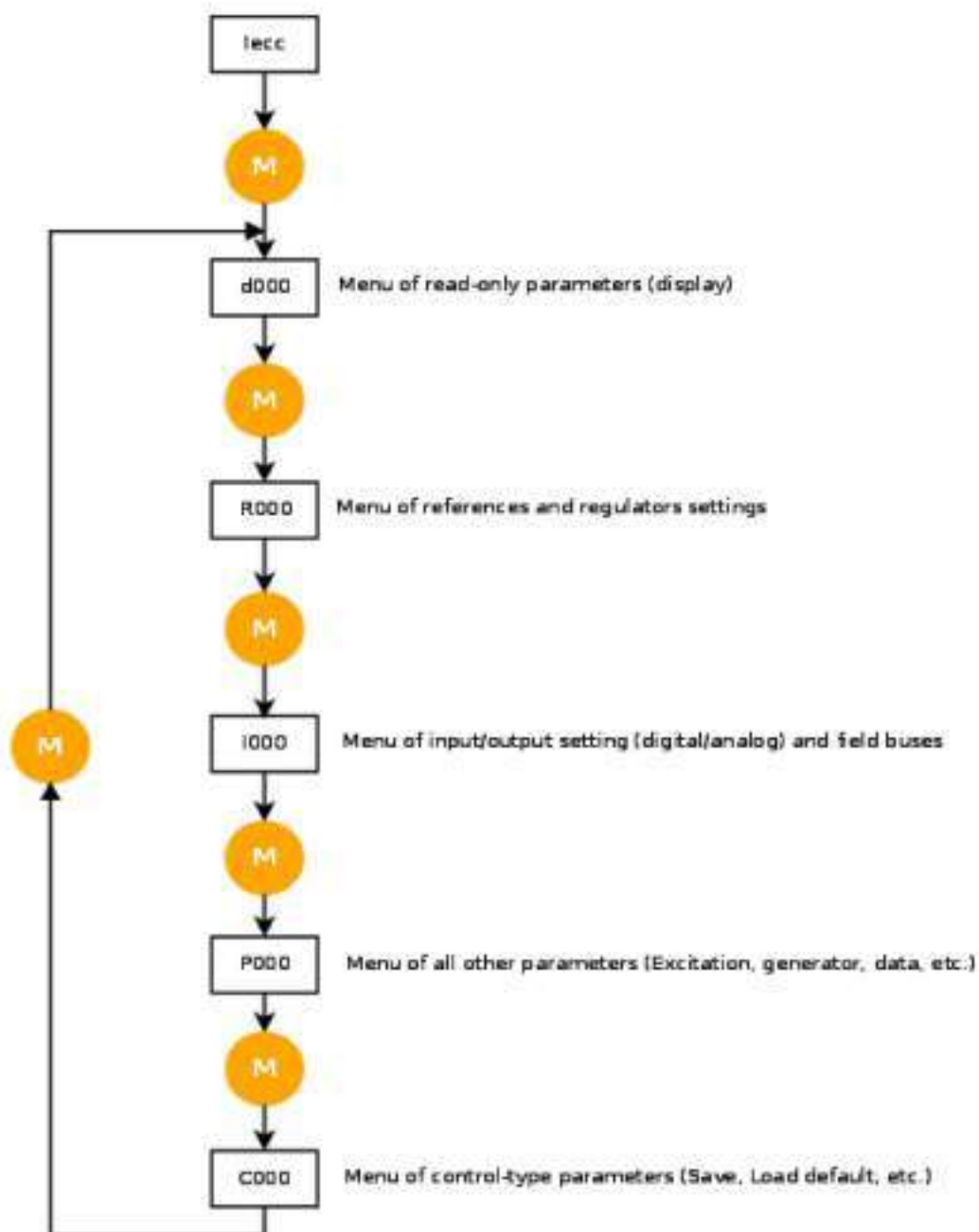

Example: how to change the lecc reference

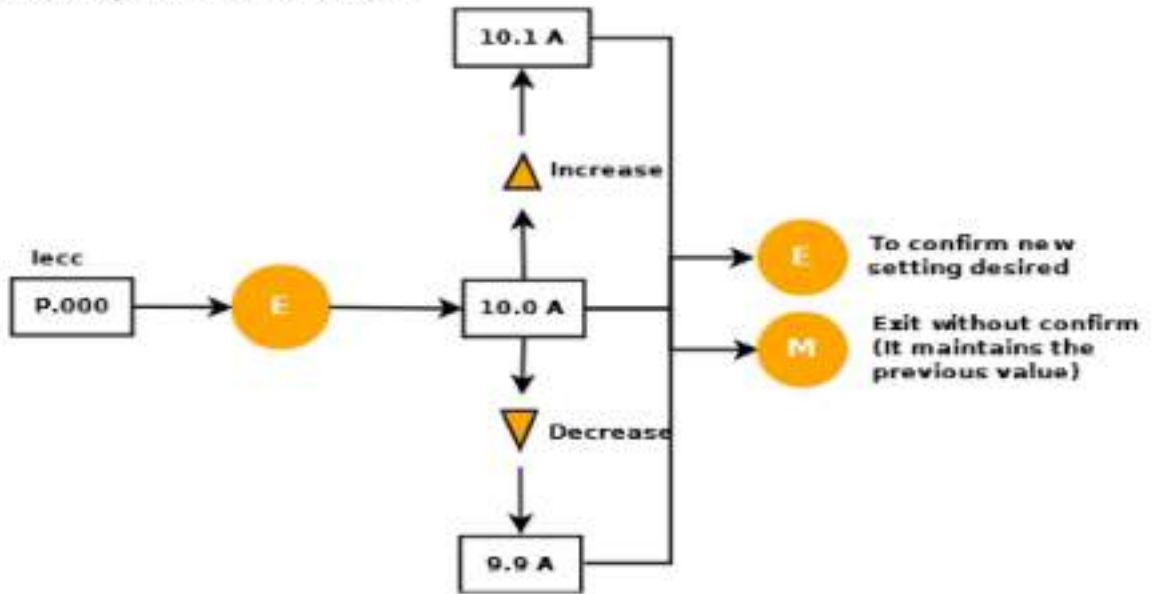

Example: how to save the parameters after the change

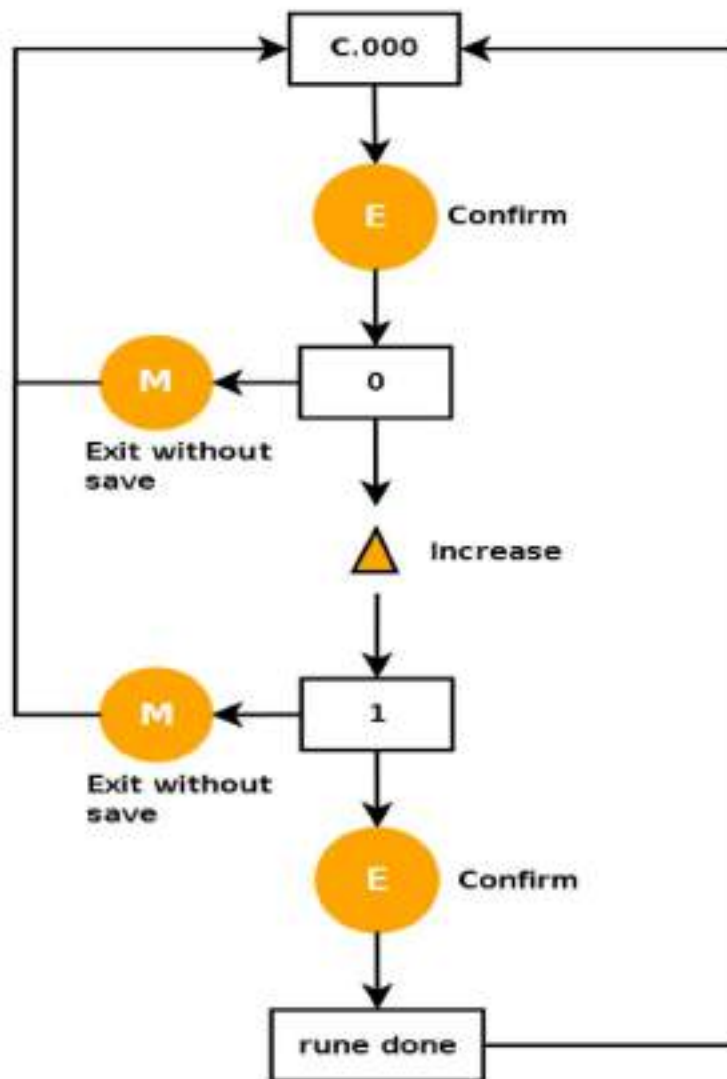

3.3 Display

3.3.1 Field

Parameter	Description	Notes
d.000	Field current expressed in % of the excitation rated current (P.000)	
d.001	Field current reference expressed in % of the excitation rated current (P.000)	
d.005	Ripple level of the field current in % of the excitation rated current (P.000)	
d.010	Field voltage expressed in % of the excitation rated voltage (P.010)	
d.011	Field voltage reference expressed in % of the excitation rated voltage (P.010)	
d.020	Duty Cycle expressed in %	
d.021	Duty Cycle reference expressed in %	
d.030	Time left in case of intervention of the limitation of the maximum current of excitation	

3.3.2 Generator

Parameter	Description	Notes
d.100	Generator voltage L1-L2 expressed in % of the generator rated voltage (P.100)	
d.101	Generator voltage L2-L3 expressed in % of the generator rated voltage (P.100)	
d.102	Generator voltage L3-L1 expressed in % of the generator rated voltage (P.100)	
d.103	Generator voltage reference expressed in % of the generator rated voltage (P.100)	
d.104	Generator frequency expressed in HZ	
d.110	Generator current expressed in % of the generator rated current (P.110)	
d.111	Generator power factor	
d.112	Generator power factor reference	
d.120	Generator apparent power expressed in % of the generator rated power (P.100xP.110)	
d.121	Generator active power expressed in % of the generator rated power (P.100xP.110)	
d.122	Generator reactive power expressed in % of the generator rated power (P.100xP.110)	
d.123	Generator reactive power reference expressed in % of the generator rated power (P.100xP.110)	
d.130	Time left in case of intervention of the limitation of the maximum current of generator	

3.3.3 Mains

Parameter	Description	Notes
d.200	Mains voltage expressed in % of the generator rated voltage (P.100)	
d.201	Mains frequency expressed in HZ	
d.210	Sync slip expressed in HZ	
d.211	Delta Phase expressed in deg	
d.212	Last circuit breaker closing time	
d.213	Last Synchronization Time	

3.3.4 Actual regulation

Parameter	Description	Notes
d.300	Control status	0 Fault 1 Stop 2 PWM control 3 FVR control 4 FCR control 5 Wait frequency 6 Ramp 7 AVR control 8 PF/VAR control
d.301	Control mode	As P.300
d.302	Reference	
d.303	Feedback	
d.304	Error	
d.310	Proportional plus derivative gain	
d.311	Integral gain	
d.312	Regulator out	
d.330	Active limits	bit mapping (hex codes): 0001 Minimum frequency 0002 V/Hz 0004 Ramp 0008 Under excitation 0010 Minimum current 0020 Minimum reactive power 0040 calibrator at minimum 0080 ---Reserved--- 0100 calibrator at maximum 0200 Over excitation 0400 Field lxt 0800 Generator lxt 1000 Generator current 2000 Generator Voltage 4000 Maximum reactive power

3.3.5 Digital & Analog Inputs/Outputs monitor

Parameter	Description	Notes
d.400	Digital inputs monitor	
d.401	Digital inputs local monitor	
d.402	Digital inputs remote monitor	
d.410	Digital outputs monitor	
d.411	Digital outputs local monitor	
d.412	Digital outputs remote monitor	
d.420	Analog input 1 monitor (filtered)	
d.421	Analog input 1 monitor (conditioned)	
d.422	Analog input 1 monitor (raw)	
d.423	Analog input 1 monitor (local)	
d.424	Analog input 1 monitor (remote)	
d.430	Analog input 2 monitor (filtered)	
d.431	Analog input 2 monitor (conditioned)	
d.432	Analog input 2 monitor (raw)	

d.433	Analog input 2 monitor (local)	
d.434	Analog input 2 monitor (remote)	
d.440	Analog output 1 monitor (filtered)	
d.441	Analog output 1 monitor (conditioned)	
d.442	Analog output 1 monitor (raw)	
d.450	Analog output 2 monitor (filtered)	
d.451	Analog output 2 monitor (conditioned)	
d.452	Analog output 2 monitor (raw)	

3.3.6 Fieldbus

Parameter	Description	Notes
d.500	CAN Rx errors	
d.501	CAN Tx errors	
d.502	CAN status	

3.3.7 Alarms

Parameter	Description	Notes
d.800	Faults (Mask Low)	bit mapping (hex codes): 0001 Over current O.C. 0002 Watchdog UUdG 0004 Over heating OH 0008 External fault E.F 0010 Excitation over load E.OVL 0020 Serial time out1 StO.1 0040 Serial time out 2 StO.2 0080 Power supply feedback loss PS.Fb 0100 Parallel switch fault PArAL 0200 TV loss tV.L 0400 TV asymmetrical tV.ASY 0800 Rotor diode open r.D.O 1000 Rotor diode short r.D.S 2000 Under voltage U.V 4000 Temperature sensor error t.S.Er 8000 TA loss tA.L
d.801	Faults (Mask High)	bit mapping (hex codes): 0001 Brake Resistor over heating b.r.OH 2000 Params error P.Err 4000 Params file error P.F.Er 8000 Configuration file error C.F.Er
d.810	Warnings (Mask Low)	As d.800
d.811	Warnings (Mask High)	As d.801

3.3.8 Fault log details

Parameter	Description	Notes
d.850	Faults L	As d.800
d.851	Faults H	As d.801
d.852	Warnings L	As d.810
d.853	Warnings H	As d.811
d.854	Power on time L	As d.980
d.855	Power on time H	As d.981

d.856	Run time L	As d.982
d.857	Run time H	As d.983
d.858	Field Current	As d.000
d.859	Field Voltage	As d.010
d.860	Generator Voltage L1-L2	As d.100
d.861	Generator Freq. Out	As d.104
d.862	Generator Current	As d.110
d.863	Generator Power Factor	As d.111
d.864	Control Status	As d.300
d.865	Control Mode	As d.301
d.866	Ref	As d.302
d.867	Feedback	As d.303
d.868	Regulator Out	As d.312
d.869	Active limits	As d.330
d.870	Dig. Inputs monitor	As d.400
d.871	Dig. Out monitor	As d.410
d.872	DC Bus Voltage	As d.999

3.3.9 Exciter

Parameter	Description	Notes
d.900	Exciter In	
d.901	Exciter Ipk	
d.910	Exc. DC bus V max	
d.950	FW ver. & rev.	
d.951	FW release	
d.952	S/N HI	
d.953	S/N LO	
d.954	Param checksum	
d.980	Power on time L	
d.981	Power on time H	
d.982	Run time L	
d.983	Run time H	
d.997	Heatsink temp.	
d.998	Exciter IxT lev.	
d.999	DC Bus Voltage	

4. CONFIGURATION

4.1 Inputs and outputs

4.1.1 Digital inputs

The voltage regulator S2006 has 16 digital inputs.

Parameter	Input	Default	
I.000	1	1	RUN (NO)
I.001	2	25	GRID PAR SW (NO)
I.002	3	41	PF REF2 (NO)
I.003	4	31	SET RAISE (NO)
I.004	5	33	SET LOWER (NO)
I.005	6	39	Q = 0 (NO)
I.006	7	21	GRID FOLLOW (NO)
I.007	8	13	MANUAL FCR (NO)
I.008	9	35	SET PRE POS (NO)
I.009	10	5	ALARM RESET (NO)
I.010	11	8	EXTERNAL FAULT (NC)
I.011	12	0	NONE
I.012	13	0	NONE
I.013	14	0	NONE
I.014	15	0	NONE
I.015	16	0	NONE

Each input can be configured as desired, the following is the list of possible configurations:

0	NONE
1	RUN (NO)
2	RUN (NC)
3	ENABLE (NO)
4	ENABLE (NC)
5	ALARM RESET (NO) (EDGE)
6	ALARM RESET NC (EDGE)
7	EXTERNAL FAULT (NO)
8	EXTERNAL FAULT (NC)
9	MANUAL PWM (NO)
10	MANUAL PWM (NC)
11	MANUAL FVR (NO)
12	MANUAL FVR (NC)
13	MANUAL FCR (NO)
14	MANUAL FCR (NC)
15	AUTO AVR (NO)
16	AUTO AVR (NC)
17	AUTO VDC (NO)
18	AUTO VDC (NC)
19	AUTO VDC GRID2 (NO)
20	AUTO VDC GRID2 (NC)
21	GRID FOLLOW (NO)
22	GRID FOLLOW (NC)
23	GRID SYNC (NO)
24	GRID SYNC (NC)
25	GRID PAR SW (NO)
26	GRID PAR SW (NC)
27	AUTO PF (NO)
28	AUTO PF (NC)
29	AUTO VAR (NO)
30	AUTO VAR (NC)
31	SET RAISE (NO)
32	SET RAISE (NC)
33	SET LOWER (NO)
34	SET LOWER (NC)
35	SET PRE POS (NO)
36	SET PRE POS (NC)
37	MASTER FAIL (NO)
38	MASTER FAIL (NC)
39	Q = 0 (NO)
40	Q = 0 (NC)
41	PF REF2 (NO)
42	PF REF2 (NC)
43	150% (NO)
44	150% (NC)
45	SUPPLY BUILDUP (NO)
46	SUPPLY BUILDUP (NC)
47	V GEN REF2 (NO)
48	V GEN REF2 (NC)
49	VF LIMIT DISABLE (NO)
50	VF LIMIT DISABLE (NC)
51	BRAKE R THERMAL SENS (NO)
52	BRAKE R THERMAL SENS (NC)

4.1.2 Enabling virtual digital inputs

Through a "virtual setting" via serial line or fieldbus, it is possible to use all the functions available on the digital inputs.

The setting can be carried out in such configurations, where the digital commands are a mix of "virtual" and terminals.

The virtual assignment can be performed through the parameter C.500.

Below is the reported the drawing describing the combination between the byte of the virtual inputs and the drive terminals, with the relative decoder mask.

The switch between the "virtual" commands and the terminals is determined by programmable mask I.050. These parameters have to be managed bitwise. At each bit corresponds a switch, as follows.

Parameter	Description	Notes
I.050	Remote enable mask	0 Terminal 1 Virtual

The formula below describes the result of the virtual inputs setting:

$$[\text{Input AND (NOT Mask)}] \text{ OR (Virtual AND Mask)}$$

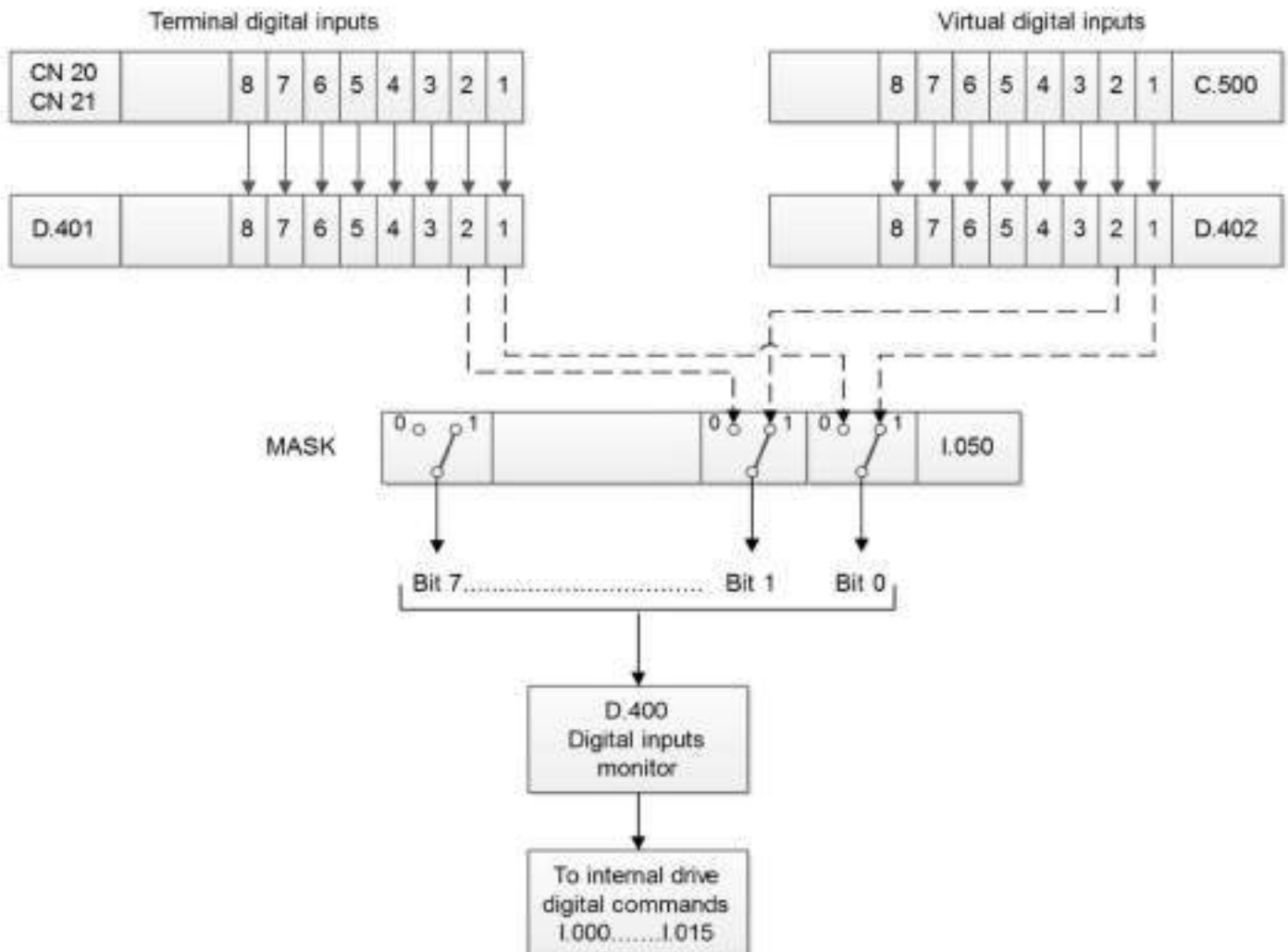

4.1.3 Digital outputs

The voltage regulator S2006 has 16 digital outputs.

Parameter	Output	Default
I.100	1	9 Parallel CB (NO)
I.101	2	39 Q = 0 (NO)
I.102	3	13 Calibrator max (NO)
I.103	4	11 Calibrator min (NO)
I.104	5	19 Manual mode (NO)
I.105	6	3 Fault (NO)
I.106	7	21 PF 2nd reference (NO)
I.107	8	0 None
I.108	9	0 None
I.109	10	1 Run (NO)
I.110	11	0 None
I.111	12	0 None
I.112	13	0 None
I.113	14	0 None
I.114	15	0 None
I.115	16	0 None

Each output can be configured as desired, the following is the list of possible configurations:

0	None	25	Boost (NO)	50	Control mode FVR (NC)
1	Run (NO)	26	Boost (NC)	51	Control mode FCR (NO)
2	Run (NC)	27	Warning (NO)	52	Control mode FCR (NC)
3	Fault (NO)	28	Warning (NC)	53	Control mode AVR (NO)
4	Fault (NC)	29	Warning Mask1 (NO)	54	Control mode AVR (NC)
5	Ready (NO)	30	Warning Mask1 (NC)	55	Control mode PF (NO)
6	Ready (NC)	31	Warning Mask2 (NO)	56	Control mode PF (NC)
7	Watchdog (NO)	32	Warning Mask2 (NC)	57	Control mode VAR (NO)
8	Watchdog (NC)	33	Limits Any (NO)	58	Control mode VAR (NC)
9	Parallel CB (NO)	34	Limits Any (NC)	59	Thermal warning (NO)
10	Parallel CB (NC)	35	Limits Mask1 (NO)	60	Thermal warning (NC)
11	Calibrator min (NO)	36	Limits Mask1 (NC)	61	Gen V Calib >= 100% (NO)
12	Calibrator min (NC)	37	Limits Mask2 (NO)	62	Gen V Calib >= 100% (NC)
13	Calibrator max (NO)	38	Limits Mask2 (NC)	63	Speed Up (NO)
14	Calibrator max (NC)	39	Q = 0 (NO)	64	Speed Up (NC)
15	PF = 1 (NO)	40	Q = 0 (NC)	65	Speed Down (NO)
16	PF = 1 (NC)	41	Grid V matching (NO)	66	Speed Down (NC)
17	Exciter Overload (NO)	42	Grid V matching (NC)		
18	Exciter Overload (NC)	43	Grid F matching (NO)		
19	Manual mode (NO)	44	Grid F matching (NC)		
20	Manual mode (NC)	45	Calibrator at preset (NO)		
21	PF 2nd reference (NO)	46	Calibrator at preset (NC)		
22	PF 2nd reference (NC)	47	Control mode PWM (NO)		
23	Field Flashing (NO)	48	Control mode PWM (NC)		
24	Field Flashing (NC)	49	Control mode FVR (NO)		

4.1.4 Enabling virtual digital outputs

Through a "virtual setting" via serial line or fieldbus, it is possible to use all the functions available on the digital outputs.

The setting can be carried out in such configurations, where the outputs are a mix of "virtual" and drive function.

The virtual assignment can be performed through the parameter C.550.

Below is the reported the drawing describing the combination between the byte of the virtual outputs and the drive terminals, with the relative decoder mask.

The switch between the "virtual" outputs and the drive functions is determined by programmable mask I.150.

These parameters have to be managed bitwise. At each bit corresponds a switch, as follows.

Parameter	Description	Notes
I.150	Remote enable mask	0 Drive function 1 Virtual control

The formula below describes the result of the virtual outputs setting:

$$[\text{Output AND (NOT Mask)}] \text{ OR (Virtual AND Mask)}$$

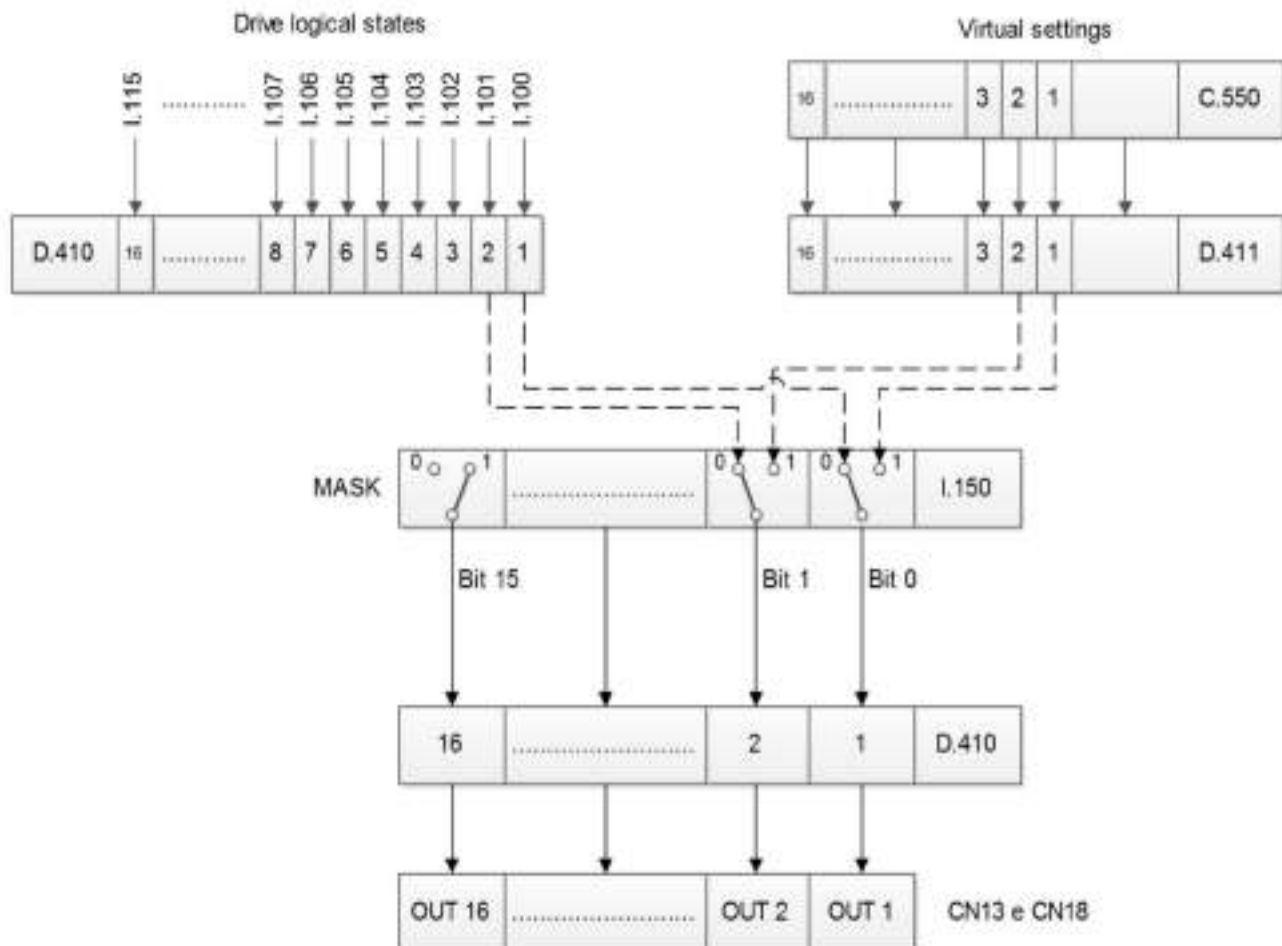

4.1.5 Fast De-Excitation output

In the event of a fault or stop, the fast de-excitation output command allows all the energy stored in the field circuit to be discharged through an appropriately sized de-excitation resistor.

The regulator through the CN23 connector output can control a de-excitation module (optional) which inserts or short circuits an appropriate resistor (optional) connected in series to the field circuit.

Through the parameter I.160 it is possible to set the function type of the rapid de-excitation output.

Parameter	Description	Notes
I.160	De-Excitation mode	0 Active at FAULT 1 Not-active at FAULT 2 Active at STOP 3 Not-active at STOP

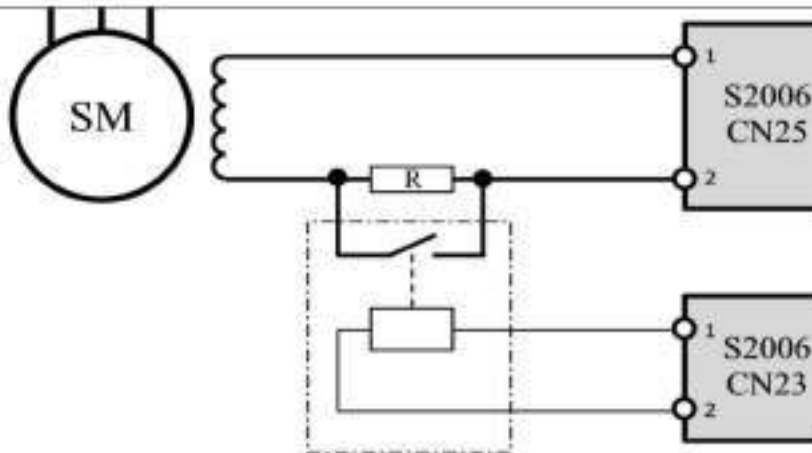

I.160=1

The output will deactivate for one of the following reasons:

- when there is a fault with the regulator due to internal or external causes (if an input of I.0xx=7 or 8 is configured)
- when disabled

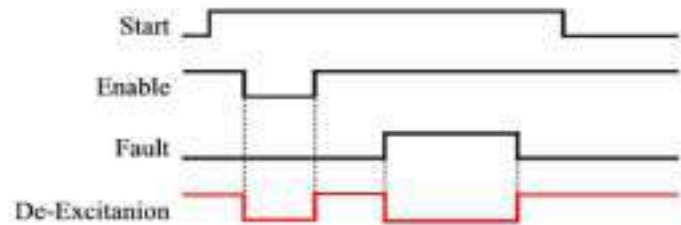

I.160=3

The output will deactivate for one of the following reasons:

- when it does not START
- when disabled
- in the case of a FAULT

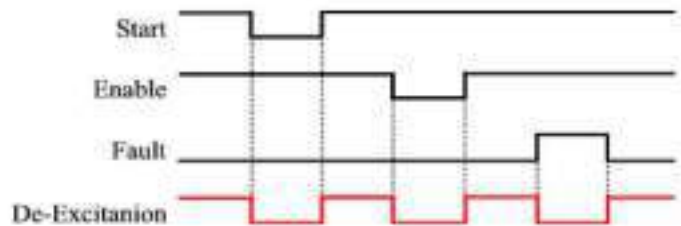

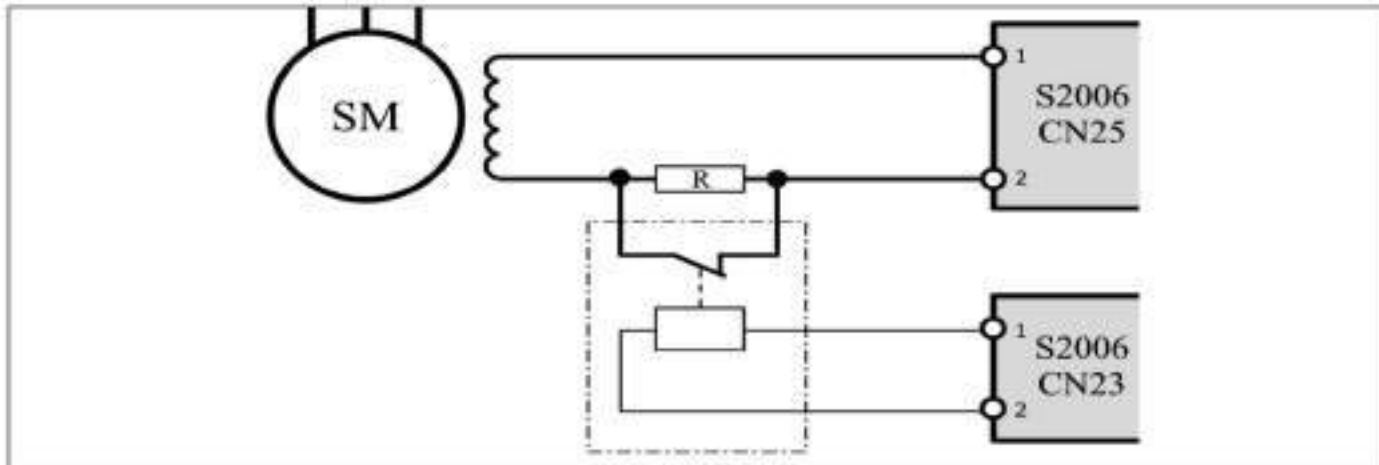

I.160=0
 The output will activate for one of the following reasons:

- when there is a fault with the regulator due to internal or external causes (if an input of I.0xx=7 or 8 is configured)
- when disabled

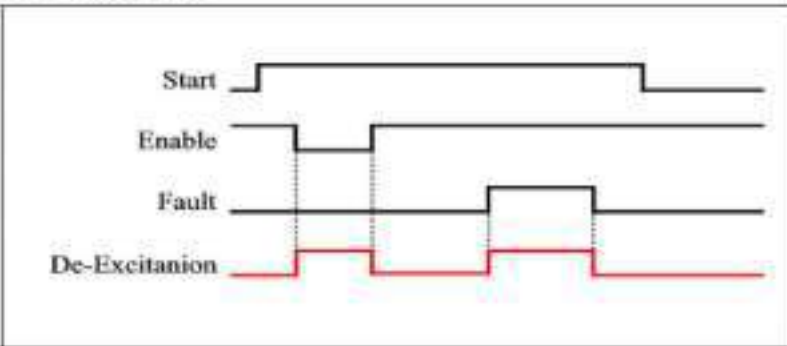

I.160=2
 The output will deactivate for one of the following reasons:

- when it does not START
- when disabled
- in the case of a FAULT

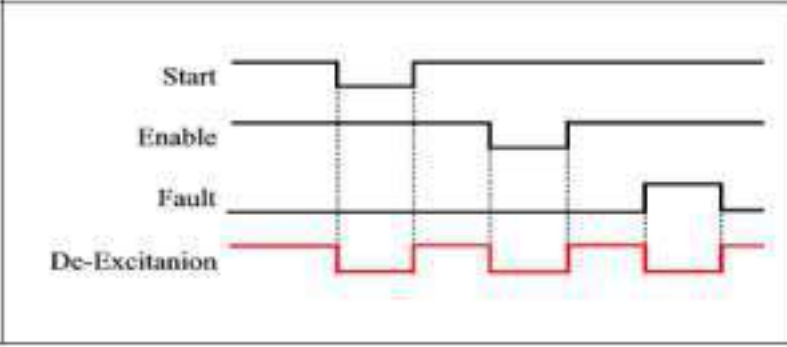

4.1.6 Analog inputs

The voltage regulator S2006 has 16 analog outputs.

Parameter	Description	Notes
I.200	Type of Input	0 voltage (-10 / +10V) 1 current (-20 / +20 mA)
I.201	Input coordinate X1	Configurable from -100% to I.202
I.202	Input coordinate X2	Configurable from I.201 to 100%
I.203	Output coordinate Y1	Configurable from -400% to 400%
I.204	Output coordinate Y2	Configurable from -400% to 400%
I.205	Filter	Configurable from 0 to 2s

To correctly configure the analog input required, you must configure the range of the analog input and the corresponding range of the output you wish to control.

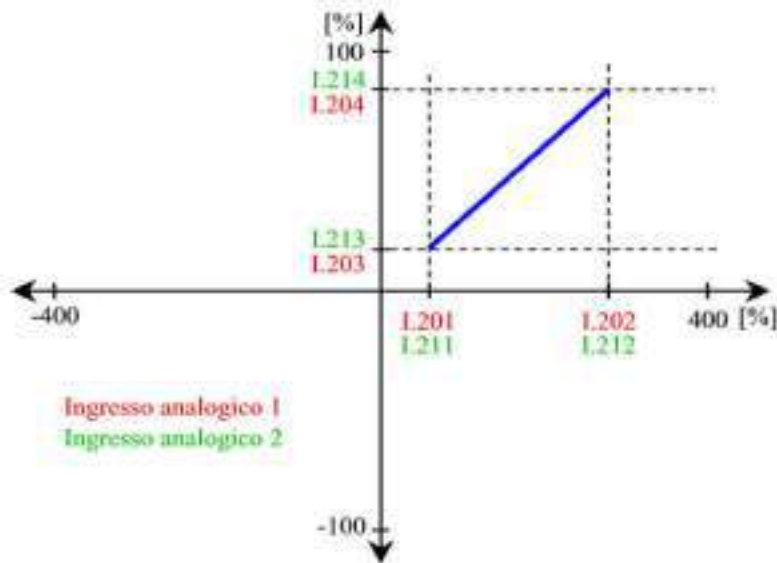

Example:

In the event you want to vary the voltage reference in a range that goes from 85 to 105% of the nominal voltage through an analog input 4-20mA, where 85% corresponds to 4mA and 105% corresponds to 20mA, proceed as follows:

1. set the parameter I.200=1 (current input)
2. set the parameter I.201=20 (the coordinate X1 in input where 4mA correspond to 20%)
3. set the parameter I.202=100 (the coordinate X2 in input where 20mA correspond to 100%)
4. set the parameter I.203=85 (the coordinate Y1 in output)
5. set the parameter I.204=105 (the coordinate Y2 in output)

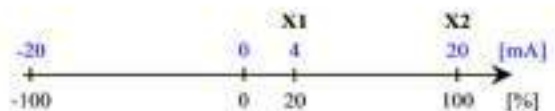

In this way there is a linear variation of the analog input function voltage reference

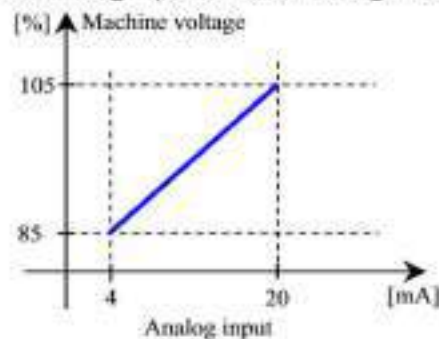

Similar considerations can be made when configuring the second analog input

Parameter	Description	Notes
I.210	Type of Input	0 voltage (-10 / +10V) 1 current (-20 / +20 mA)
I.211	Input coordinate X1	Configurable from -100% to I.212
I.212	Input coordinate X2	Configurable from I.211 to 100%
I.213	Output coordinate Y1	Configurable from -400% to 400%
I.214	Output coordinate Y2	Configurable from -400% to 400%
I.215	Filter	Configurable from 0 to 2s

4.1.7 Enabling virtual analog inputs

Through a "virtual setting" via serial line or fieldbus, it is possible to use all the functions available on the analog inputs.

The setting can be carried out in such configurations, where the analog commands are a mix of "virtual" and terminals.

The virtual assignment can be performed through the parameter C.600/C.601.

Below is the reported the drawing describing the combination between the byte of the virtual inputs and the drive terminals, with the relative decoder mask.

The switch between the "virtual" commands and the terminals is determined by programmable mask I.050.

These parameters have to be managed bitwise. At each bit corresponds a switch, as follows.

Parameter	Description	Notes
I.250	Remote enable mask	0 Terminal 1 Virtual

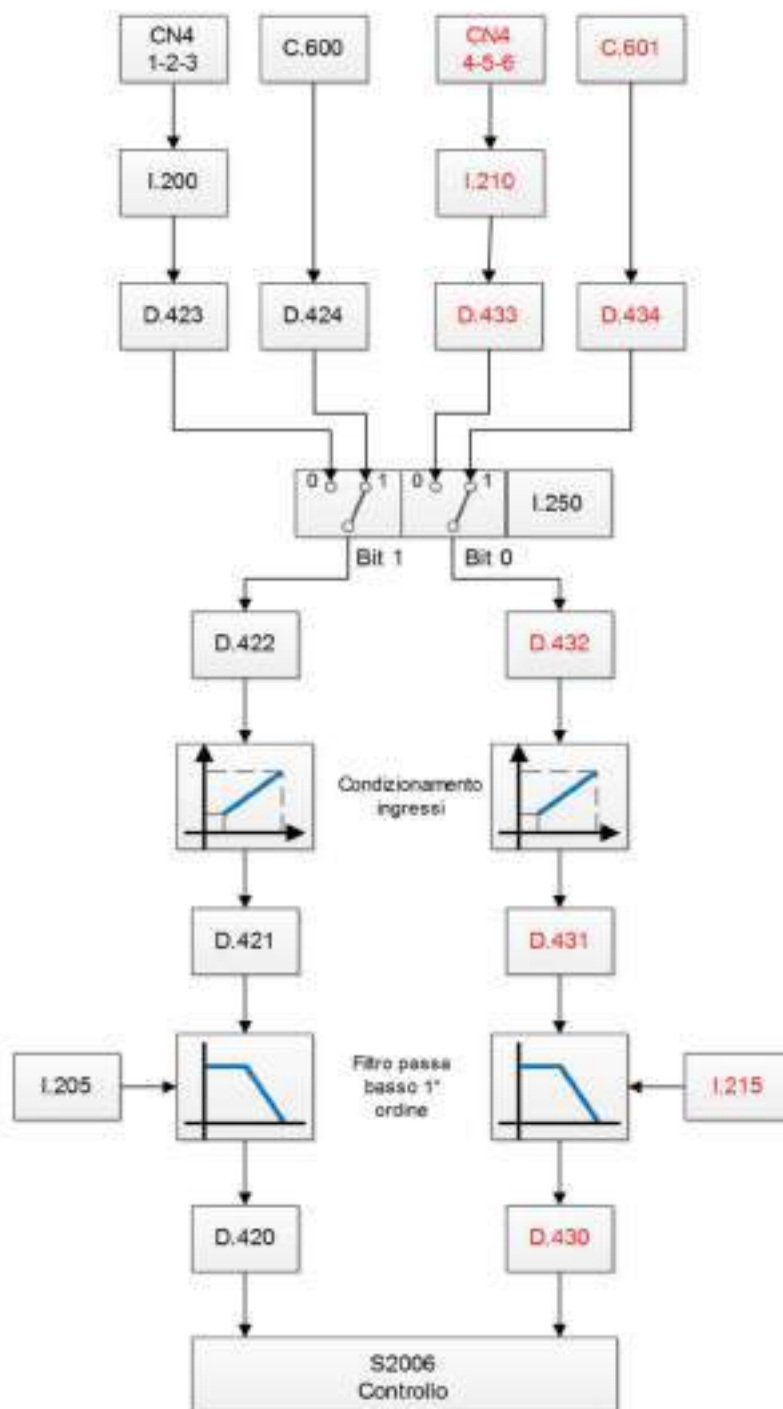

4.1.1 Analog Outputs

The voltage regulator S2006 has two analog outputs configurable between 0-20mA.

Through the analog output controlled current, it is possible to have any size listed in the table (parameter I.300).

Parameter	Description	Notes
I.300	Size Available	0 Field I 1 Field V 2 Out Duty 3 Generator V 4 Generator I 5 Generator P 6 Generator Q 7 Generator S 8 Generator PF 9 Mains V 10 Actual Reg. Reference 11 Actual Reg. Feedback 12 Actual Reg. Error 13 Actual Reg. P+D 14 Actual Reg. I 15 Actual Reg. Output 16 Remote 17 DC Bus Voltage 18 Sync freq. Adj 19 An Input 1 20 An Input 2
I.301	Input coordinate X1	Configurable from -400% to I.302
I.302	Input coordinate X2	Configurable from I.301 to 400%
I.303	Output coordinate Y1	Configurable from 0 to 100%
I.304	Output coordinate Y2	Configurable from 0 to 100%
I.305	Filter	Configurable from 0 to 2s

To correctly configure the output, the procedure is similar to that shown in the previous paragraph for the configuration of the analog inputs.

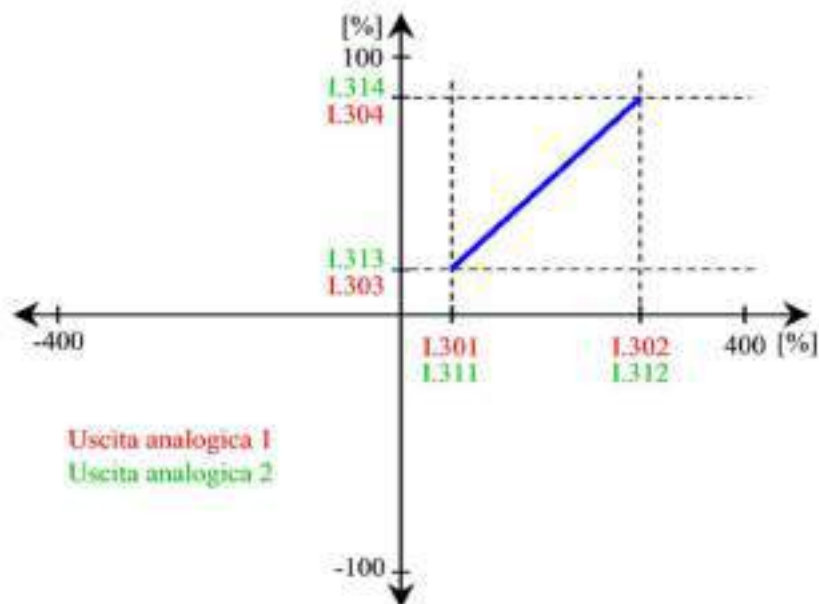

Example:

In the case where you want the excitation current with a range from 0 to 150% of the nominal excitation current through the analog output 4-20mA, where 0 corresponds to 4mA and 150% corresponds to 20mA, you can proceed as follows:

1. set the parameter I.300=0 (excitation current)
2. set the parameter I.301=0 (coordinate X1 of the size selected)
3. set the parameter I.302=150 (the coordinate X2 of the size selected)
4. set the parameter I.303=20 (the coordinate Y1 in output where 4mA correspond to 20%)
5. set the parameter I.304=100 (the coordinate Y2 in output where 20mA correspond to 100%)

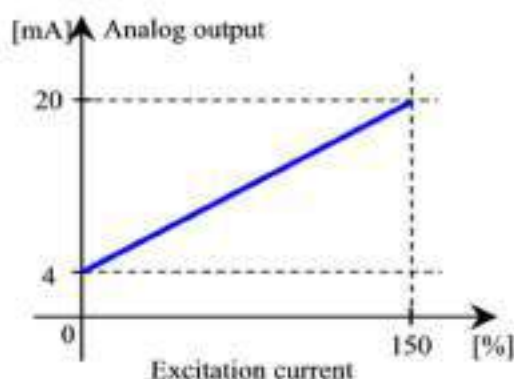

In this way there is a linear analog output variation depending on the excitation current.



Similar considerations can be made to configure the second analog output

Parameter	Description	Notes
I.310	Size Available	See the previous table
I.311	Input coordinate X1	Configurable from -400% to I.302
I.312	Input coordinate X2	Configurable from I.301 to 400%
I.313	Output coordinate Y1	Configurable from 0 to 100%
I.314	Output coordinate Y2	Configurable from 0 to 100%
I.315	Filter	Configurable from 0 to 2s

4.1.1 Enable Virtual Analog Outputs

This parameter allows, through the "virtual setting" (from field Bus), the remote control of the analog outputs. When the parameter I.300 is set at 16, the analog output 1 is controlled by the value set in parameter C.

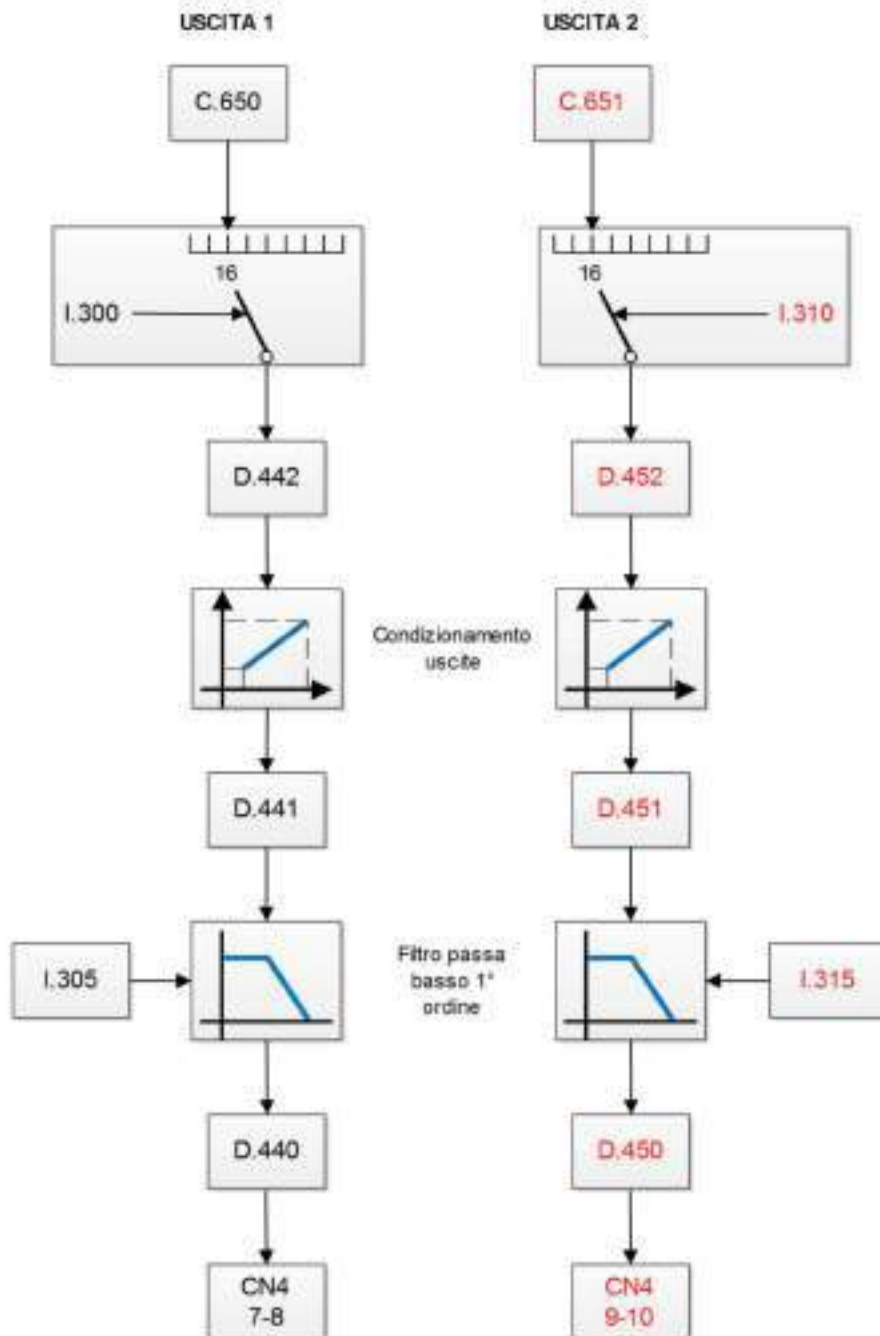

4.1.1 RS485 Communication

<i>Parameter</i>	<i>Description</i>	<i>Notes</i>
I.400	RS485 config	0 disabled 1 Modbus RTU 8N1 2 Modbus RTU 8E1 3 Modbus RTU 8O1 4 Modbus RTU 8N2
I.401	RS485 bitrate	0 4800 1 9600 2 19200 3 38400 4 57600 5 115200
I.402	RS485 node ID	Configurable from 1 to 247
I.403	RS485 timeout	Configurable from 0-25 seconds
I.404	RS485 delay	Configurable from 0 to 0.1 seconds

4.1.1 USB Communication

<i>Parameter</i>	<i>Description</i>	<i>Notes</i>
I.450	USB config	0 Disabled 1 Modbus RTU 8N1 2 Modbus RTU 8E1 3 Modbus RTU 8O1 4 Modbus RTU 8N2
I.451	USB bitrate	0 4800 1 9600 2 19200 3 38400 4 57600 5 115200
I.452	USB node ID	Configurable from 1 to 247
I.453	USB timeout	Configurable from 0-25 seconds

4.1.1 CAN bus communication

<i>Parameter</i>	<i>Description</i>	<i>Notes</i>
I.500	CAN config	0 Disabled 1 CAN proprietary 2 CAN open
I.501	CAN bitrate	0 20 kBps 1 50 kBps 2 125 kBps 3 250 kBps 4 500 kBps 5 800 kBps 6 1 MBps
I.502	CAN node ID	Configurable from 1 to 127

4.1.1 Ethernet communication

Parameter	Description	Notes
I.600	Ethernet mode	0 disabled 1 Modbus/TCP server
I.610	IP address b1	From 1 to 255
I.611	IP address b2	From 1 to 255
I.612	IP address b3	From 1 to 255
I.613	IP address b4	From 1 to 255
I.620	IP subnet mask b1	From 1 to 255
I.621	IP subnet mask b2	From 1 to 255
I.622	IP subnet mask b3	From 1 to 255
I.623	IP subnet mask b4	From 1 to 255
I.630	IP gateway b1	From 1 to 255
I.631	IP gateway b2	From 1 to 255
I.632	IP gateway b3	From 1 to 255
I.633	IP gateway b4	From 1 to 255

4.2 Description and Configuration Parameters

4.2.1 Field excitation data

Parameter	Description	Notes
P.000	Field rated current expressed in A	Iecc
P.001	Field over excitation limit expressed in % of the excitation rated current (P.000)	
P.002	Field under excitation limit expressed in % of the excitation rated current (P.000)	
P.010	Field rated voltage expressed in V	Vecc
P.011	Field maximum voltage expressed in % of the excitation rated current (P.010)	
P.020	Field resistance expressed in Ω	
P.021	Field inductance expressed in H	
P.030	Field thermal I expressed in % of the excitation rated current (P.000)	
P.031	Field over excitation delay time	
P.032	Field over excitation limit time	
P.050	Rotors poles pair	

4.2.1 Minimum Excitation Current

The minimum excitation current is enabled only with machine in parallel network. It shows the minimum excitation current, under which, the machine cannot work.

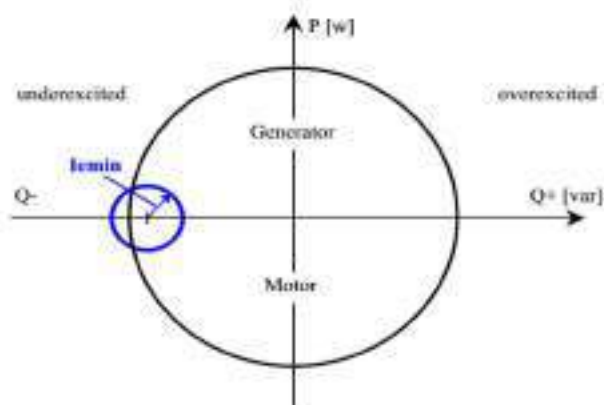

Parameter	Description	Notes
P.002	Field under excitation limit expressed in % of the excitation rated current (P.000)	

4.2.1 Maximum Excitation Current

The limit of maximum excitation current operates a limit on the maximum excitation current.

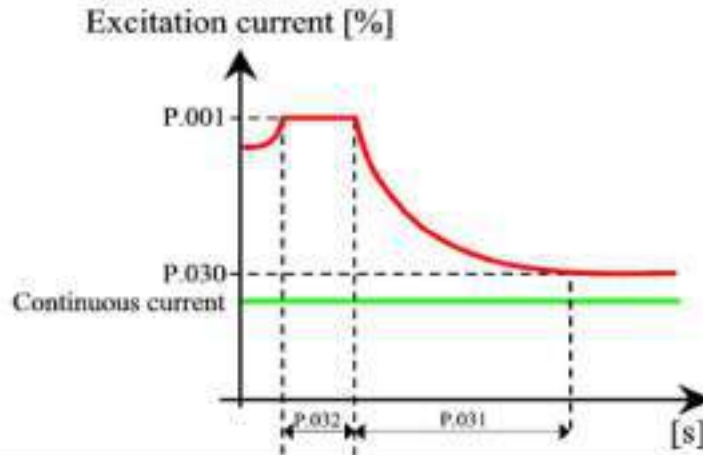

Parameter	Description	Notes
P.001	Field over excitation limit expressed in % of the excitation rated current (P.000)	[%]
P.030	Field thermal I expressed in % of the excitation rated current (P.000)	[%]
P.031	Field over excitation delay time	[s]
P.032	Field over excitation limit time	[s]

4.2.2 Generator data

Parameter	Description	Notes
P.100	Generator rated voltage	[V]
P.101	Generator maximum voltage expressed in % of the generator rated voltage (P.100)	[%]
P.102	Generator minimum voltage expressed in % of the generator rated voltage (P.100)	[%]
P.110	Generator rated current	[A]
P.111	Generator maximum current expressed in % of the generator rated current (P.110)	[%]
P.112	Generator minimum current expressed in % of the generator rated current (P.110)	[%]
P.113	Generator TA loss delay	[s]
P.120	Generator rated frequency	[Hz]
P.130	Generator V/f minimum frequency expressed in % of P.120	[%]
P.131	Generator V/f maximum frequency expressed in % of P.120	[%]
P.132	Generator soft start timer	[s]
P.140	Generator thermal current expressed in % of P.110	[%]
P.141	Generator maximum current delay time	[s]
P.142	Generator maximum current time	[s]
P.150	Generator poles pair	
P.160	Limit minimum reactive power at P = 0% expressed in % of the generator rated power (P.100xP.110)	
P.161	Limit minimum reactive power at P = 25% expressed in % of the generator rated power (P.100xP.110)	
P.162	Limit minimum reactive power at P = 50% expressed in % of the generator rated power (P.100xP.110)	
P.163	Limit minimum reactive power at P = 75% expressed in % of the generator rated power (P.100xP.110)	
P.164	Limit minimum reactive power at P = 100% expressed in % of the generator rated power (P.100xP.110)	
P.170	Limit maximum reactive power at P = 0% expressed in % of the generator rated power (P.100xP.110)	
P.171	Limit maximum reactive power at P = 100% expressed in % of the generator rated power (P.100xP.110)	

4.2.3 Generator current

Within these parameters it is possible to set the data relating to the alternator current:

- Nominal alternator current
- Maximum current threshold of the alternator, above which the regulator tends to de-energise the alternator to bring the current within the limits.
- Minimum current threshold of the alternator, below which the PF and VAR regulators do not work.
- If the alternator current continues below the minimum current for a period longer than the "Delay amp signal loss" the alarm "TA Loss" is activated

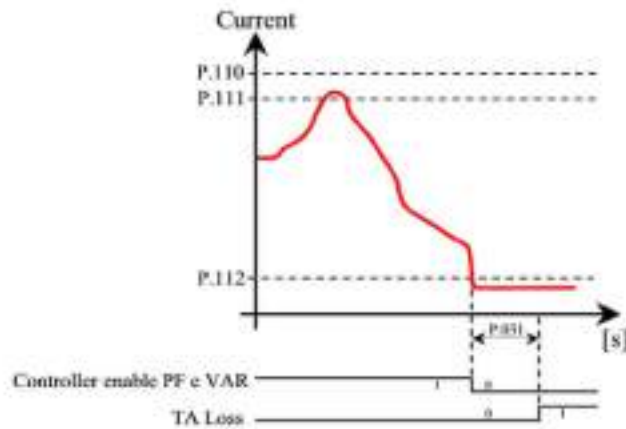

Parameter	Description	Notes
P.110	Generator rated current	[A]
P.111	Generator maximum current expressed in % of the generator rated current (P.110)	[%]
P.112	Generator minimum current expressed in % of the generator rated current (P.110)	[%]
P.113	Generator TA loss delay	[s]

4.2.1 V/Hz limit

The V/Hz limit is always active during the voltage control phase. It limits the machine voltage as soon as the frequency falls below the maximum frequency set in parameter P.131. In the event of a reduction in revolutions, this avoids over-fluxing.

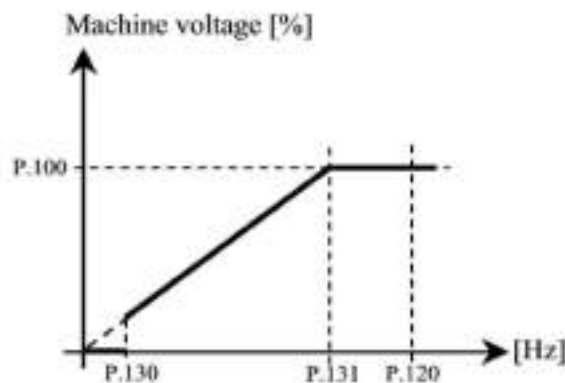

Parameter	Description	Notes
P.100	Generator rated voltage	[V]
P.120	Generator rated frequency	[Hz]
P.130	Generator V/f minimum frequency expressed in % of P.120	[%]
P.131	Generator V/f maximum frequency expressed in % of P.120	[%]

4.2.2 Soft Start

Through the configuration of parameter P.132, you can set the ramp of excitation of the machine. The soft start function is only enabled in the Auto mode

The excitation ramp is only activated if all the following conditions are met:

- Start command is active
- The alternator frequency (P.120) is greater than the minimum frequency set (P.130)

Parameter	Description	Notes
P.132	Generator soft start timer	[s]
P.100	Generator rated voltage	[V]

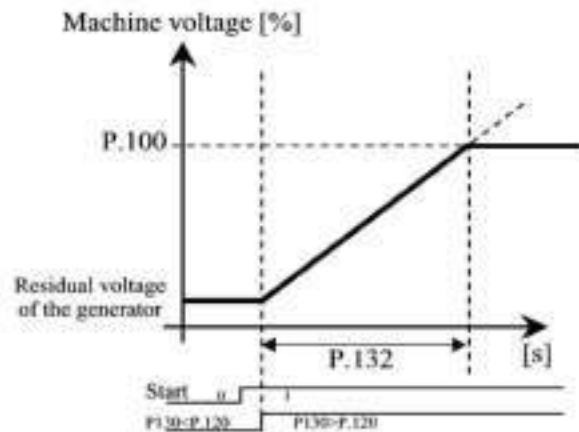

4.2.1 The Limit of Minimum Reactive Power

The limit of minimum reactive power is determined by 5 points.

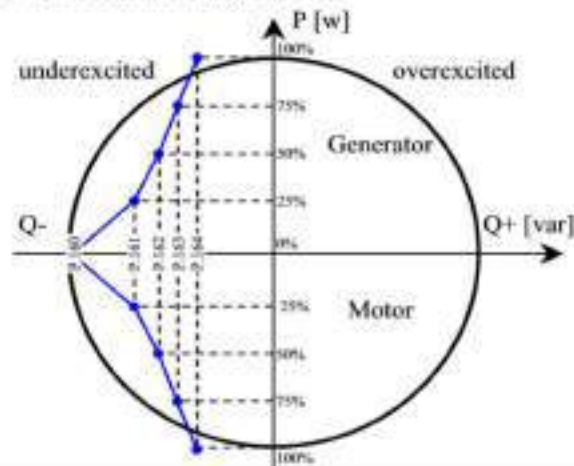

Parameter	Description	Notes
P.160	Limit minimum reactive power at P = 0% expressed in % of the generator rated power (P.100xP.110)	
P.161	Limit minimum reactive power at P = 25% expressed in % of the generator rated power (P.100xP.110)	
P.162	Limit minimum reactive power at P = 50% expressed in % of the generator rated power (P.100xP.110)	
P.163	Limit minimum reactive power at P = 75% expressed in % of the generator rated power (P.100xP.110)	
P.164	Limit minimum reactive power at P = 100% expressed in % of the generator rated power (P.100xP.110)	

4.2.1 The Limit of Maximum Reactive Power

The limit of maximum reactive power is determined by 2 points.

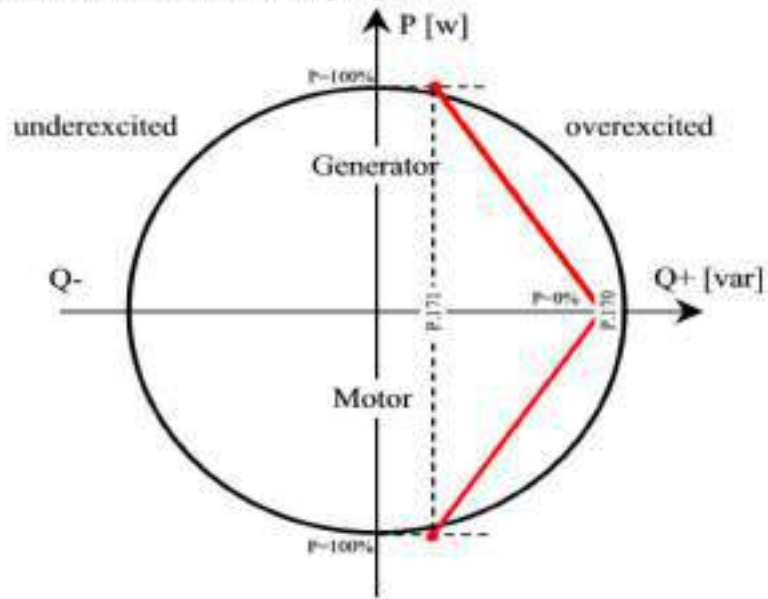

Parameter	Description	Notes
P.170	Limit maximum reactive power at P = 0% expressed in % of the generator rated power (P.100xP.110)	
P.171	Limit maximum reactive power at P = 100% expressed in % of the generator rated power (P.100xP.110)	

4.2.1 Implementation Limits

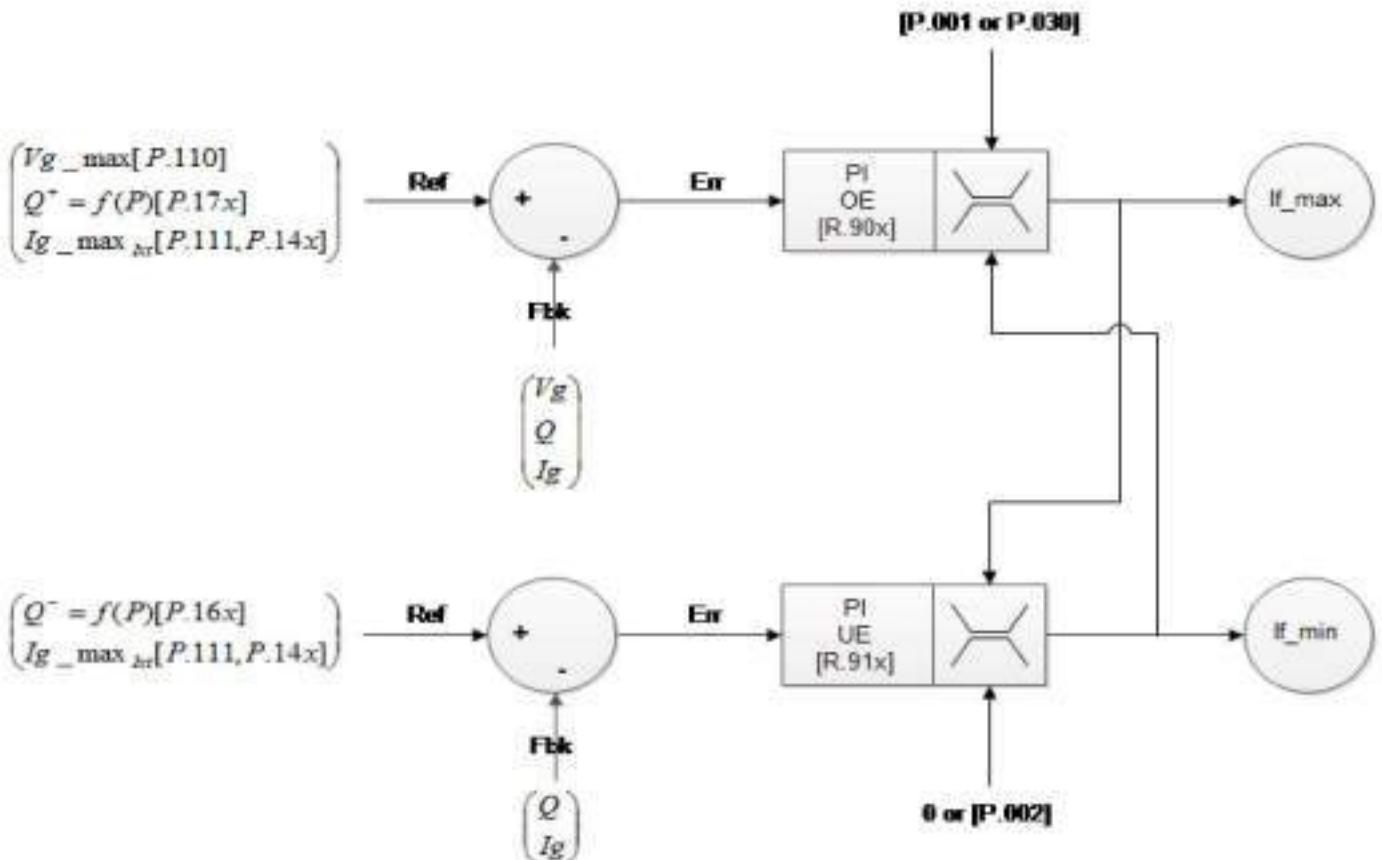

4.2.2 Sensing

Parameter	Description	Notes
P.200	Generator voltage sensing	0 single phase V sense 1 three-phase V sense
P.201	Field buildup level expressed in % of P.000	
P.210	TV Mains phase	[deg]
P.211	TV Mains K	
P.212	Mains V toll.	[%]
P.213	Mains auto follow	

4.2.3 Power supply

Parameter	Description	Notes
P.250	Supply rated voltage	

4.2.4 Control mode

The transition between the various function modes is without sensitive variations (bump-less).

It is possible to select the default control mode through parameter p.300. This can be changed at any time through a configurable digital input.

Parameter	Description	Notes
P.300	Control Mode	0 PWM 1 FVR 2 FCR 3 AVR 4 PF 5 VAR 6 PS

Open Loop (PWM)

Manual control with a fixed output voltage

Note: No limits are active.

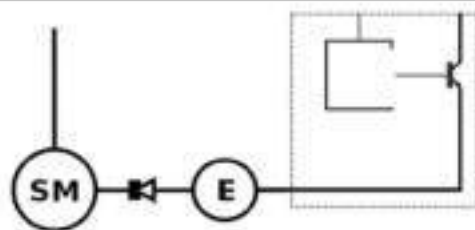

Manual Control (FVR)

It regulates the excitation voltage of the machine (or the exciter machine)

Note: The limits of the synchronous machine are deactivated.

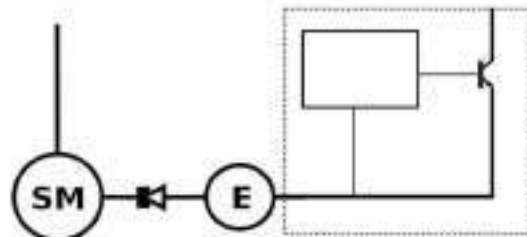

Manual Regulation (FCR)

It regulates the excitation current of the machine (or of the exciter machine).

Note: The limits of the synchronous machine are deactivated.

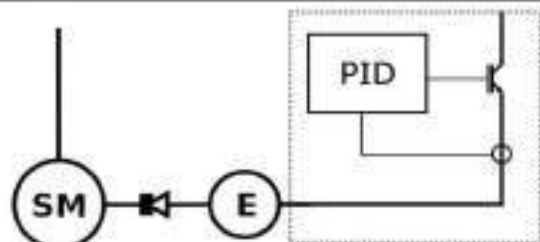

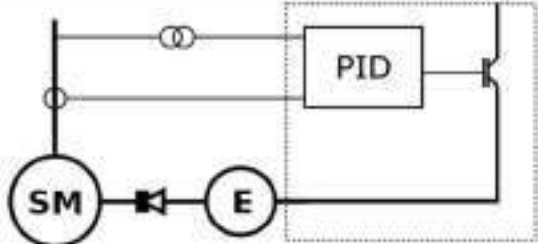
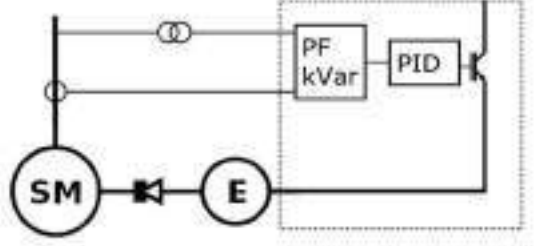
<p>Automatic voltage regulation(Auto) It regulates the voltage to the terminals of the synchronous machine. Note: Measure of the current for compensation/droop</p>	
<p>Regulation PF or VAR It regulates the power-factor or the reactive power of the synchronous machine. Note: These functions are only active with the machine switch in a closed state.</p>	

4.2.5 Droop

The compensation function ($K > 0$) is used to cancel a fall in voltage in the transformer connected downstream of the alternator.

The droop function ($K < 0$) is used when there are more generators running in parallel. A reduction of the voltage is applied depending on the reactive power supplied.

Parameter	Description	Notes
P.400	Voltage compensation K expressed in % of P.100 at reactive power=100%	
P.401	Compensation ramp time	
P.402	Primary grid ID	
P.403	Altern. grid ID	

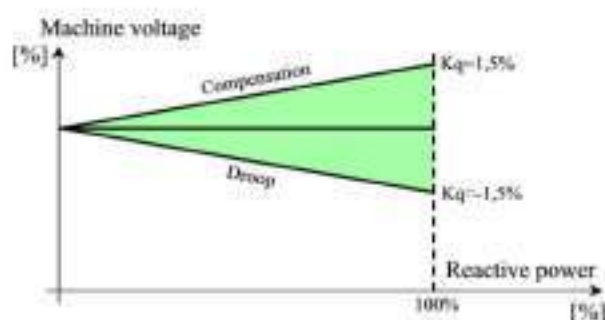

4.2.6 Series compensation

The series compensation function corrects the voltage depending on the active power supplied

Parameter	Description	Notes
P.410	Voltage compensation K expressed in % of P.100 at active power=100%	
P.411	Compensation ramp time	

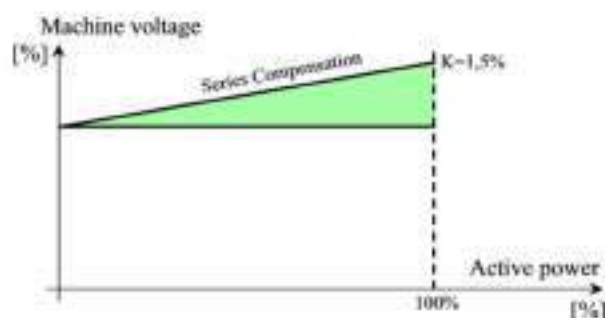

4.2.7 Field flashing

In the case where the machine does not have enough residual voltage and the power of the regulator is directly connected to the machine terminals, it is necessary to resort to field-flashing.

It is possible to configure an output on the regulator to control the pre-excitation circuit.

Once it has received the start signal, the regulator will enable the configured output. Once it has reached a minimum set threshold through the parameter "FF off level" (p.420), the output will be deactivated. If after "FF time out", configured through the parameter (P.421), the voltage does not reach the minimum threshold "FF off level", the regulator will fault.

Parameter	Description	Notes
P.420	Field flashing off level expressed in % of P.100	
P.421	Field flashing maximum time	

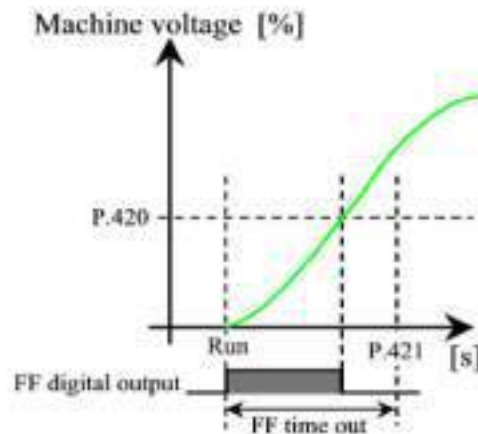

4.2.8 Boost

The Boost function enables an external circuit that allows an increase in the excitation current for a maximum set time.

Parameter	Description	Notes
P.430	Boost on level expressed in % of P.100	
P.431	Boost off hysteresis	
P.432	Boost maximum time	

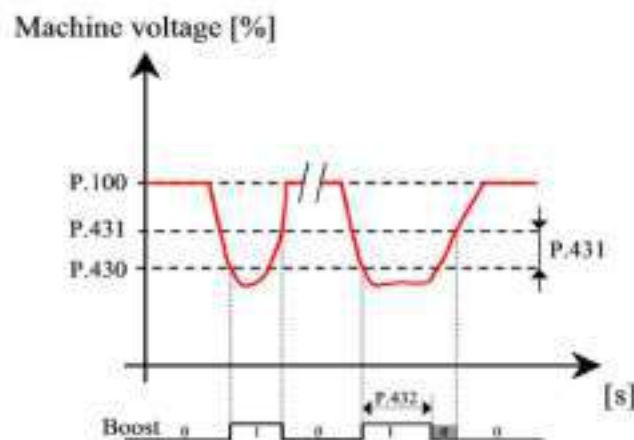

4.2.9 New Function Q

Parameter	Description	Notes
P.450		
P.451		
P.452		
P.453		
P.454		
P.455		
P.456		
P.457		

4.2.10 New Function PF

Parameter	Description	Notes
P.470		
P.471		
P.472		
P.473		

4.2.11 Rotor diode monitor

The Diode control function allows the detection of the following anomalies:

- Interruption of a diode
- Short circuit of a diode

In the brushless excitation system this function is notably important as it allows the control of the diodes installed on the rotor during its operation.

The block diagram that follows represents the excitation circuit:

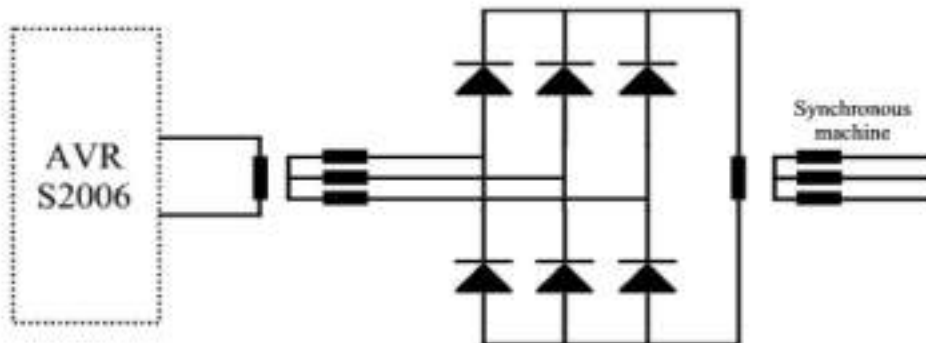

To correctly configure the diode control function it is necessary to know the rotor pole pairs and the generator pole pairs:

- Rotors poles pair P.050
- Generator pole pair P.150

The rotor pole pairs are given by the manufacturer (there are 2 by default) while the generator pole pairs can be obtained through the number of revolutions and the frequency using the following formula:

$$2p = \frac{f \cdot 60}{n}$$

where:

$2p$ is the number of the pole pairs

f is the nominal frequency of the machine [Hz]

n is the number of nominal revolutions of the machine [rpm]

During normal operations, the current in the field circuit of the exciter circuit has a very low ripple value (d.005)

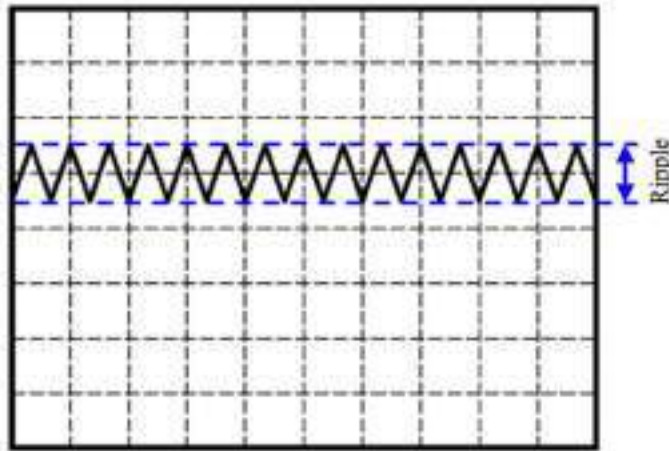

When a diode is interrupted, the ripple increases to around 3 times in relation to the value of the preceding ripple.

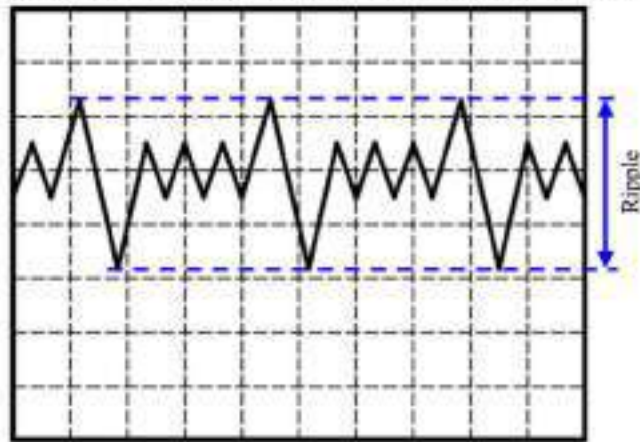

To configure the protection intervention it is necessary to specify the level of ripple and the delay in detecting the fault.

- Detect level oc P.600
- Signal delay oc P.601

In the case of diode short circuit, the ripple increases by 5 times in relation to the value of the ripple during normal operation.

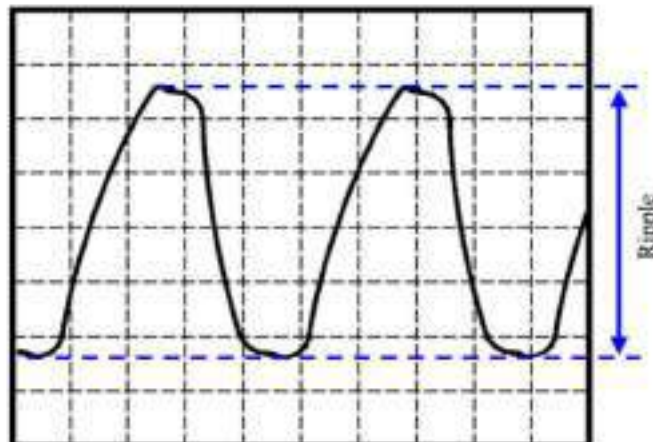

To configure the protection intervention it is necessary to specify the level of ripple and the delay in detecting the fault.

- Detect level sc P.610
- Signal delay sc P.611

Parameter	Description	Notes
P.050	Rotors poles pair	
P.150	Generator poles pair	
P.600	Detect level open circuit expressed in % of P.000	
P.601	Signal delay open circuit	
P.610	Detect level short circuit expressed in % of P.000	
P.611	Signal delay short circuit	

4.2.12 Synchronization (optional)

When the synchroniser is disabled (P.704=0) the parallel consensus output (I.1XX=9/10) activates when voltage and alternator frequency are equal, in order to enable a relay of external synchronisation.

When the synchroniser is enabled (P.704≥1) the parallel consensus output activates on impulse for 500ms when all the following conditions of synchronisation are met:

- Voltage within the admitted tolerance in parameter P.700
- Flow between the minimum (p.701) and the maximum (P.702).
- Condition of over synchronisation (P.703).
- Calculating the number of cycles reached (P.704).

The parallel consensus is anticipated in the response time of the switch (P.706).

The closure time of the switch is measured and visualised on parameter d.212.

Parameter	Description	Notes
P.700	Voltage tolerance expressed in % of P.100	
P.701	Minimum slip expressed in Hz	
P.702	Maximum slip expressed in Hz	
P.703	Generator faster	
P.704	Wait cycles	
P.706	Circuit breaker close time	
P.710	Frequency adjust type	0 analog out 1-9 inc/dec pulse duty 10-90% 10 inc/dec time linear
P.711	Frequency adjust span expressed in Hz	
P.712	Frequency adjust time expressed in s	

The S2006 can send commands to the revolution regulator either digitally or analog.

The commands are periodically updated based on parameter P712.

S2006 regulates the flow halfway between the minimum and maximum admitted (parameters P.701 and P.702). There is a dead band around the flow set (within which S2006 does not generate commands for the rpm regulator), equal to 1/3 of the distance between minimum and maximum flow. With parameter P.710=0 the command is given on the analog output whose value is proportional to the flow and has full scale given by parameter P.711.

With parameter P.710 comprised from 1 to 9, the digital commands generated have a fixed duty cycle from 10 to 90% while with P.710=10 the duty cycle is proportional to the flow, with full scale given by P.711.

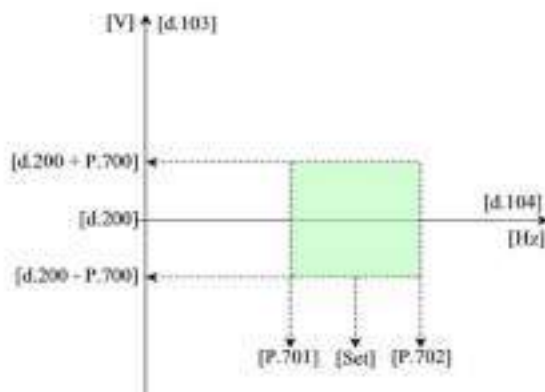

4.2.13 Alarms

<i>Parameter</i>	<i>Description</i>	<i>Notes</i>
P.800	Fault enable mask low	as D.800
P.801	Fault enable mask high	as D.801
P.810	Signal mask 1 low	as D.800
P.821	Signal mask 1 high	as D.801
P.820	Signal mask 2 low	as D.800
P.821	Signal mask 2 high	as D.801
P.830	Thermal warning temperature expressed in °C	

4.2.14 Limitations

<i>Parameter</i>	<i>Description</i>	<i>Notes</i>
P.850	Limit mask 1	as D.330
P.851	Limit mask 2	as D.330

4.2.15 Operator interface

<i>Parameter</i>	<i>Description</i>	<i>Notes</i>
P.900	F1 key configuration	0 none 1 set point raise 2 set point lower 3 set point pre position 4 alarm reset 5 jump to parameter
P.901	F1 key aux value	
P.910	F2 key configuration	as P.900
P.911	F2 key aux value	
P.920	Free led 1 configuration	As 1.000
P.921	Free led 2 configuration	As 1.000
P.980	Password level 1	
P.981	Password level 2	
P.999	Startup param	

4.3 Commands

4.3.1 Non volatile parameters

Parameter	Description	Notes
C.000	Params save	
C.001	Params reload	
C.002	Params default	

4.3.2 Self commissioning

Parameter	Description	Notes
C.100	Field auto tuning	

4.3.3 System test utilities

Parameter	Description	Notes
C.200	Test step	
C.201	Test time	
C.202	Test trigger	

4.3.4 Virtual I/O

Parameter	Description	Notes
C.500	Digital inputs remote status	
C.550	Digital outputs remote status	
C.600	Analogic input 1 remote value	
C.601	Analogic input 2 remote value	
C.650	Analogic output 1 remote value	
C.651	Analogic output 2 remote value	

4.3.5 Alarm

In the event of a fault an alarm code will appear on the display or several codes in rotation in the case of more alarms. When there is an alarm, you can no longer visualise or modify any parameter. The alarm code continues to flash on the display until the following operations are carried out:

- Reset the digital input (I.0xx=5 or 6) after the cause of the fault has been found.
- Manual reset (keys UP + DOWN) after the cause of the fault has been found.
- Identify the alarm (ACK) by pressing the key "M" for more than 1 second, in this case the display continues to flash but it is possible to visualise and/or modify the parameters. In the event you want to see the alarm code that has caused the fault, it is possible to reset the alarm identification (ACK) through parameter C.900=1

Parameter	Description	Notes
O.C	Over Current	Over Current
UUdG	Watchdog	Watch Dog
OH	Over Heating	Over heating
E.F	External Fault	External Fault
E.OVL	Exciter OVERLoad	Exciter Overload
S.IO.1	Serial TimeOut 1	Timeout communication RS485
S.IO.2	Serial TimeOut 2	Timeout Communication USB
PARAL	Parallel switch fault	
IV.L	TV loss	Failure to read the sensing voltage
TV.ASY	TV ASYmmetrical	Imbalance greater than 20% between the 3 sensing voltages observed (valid only if the system is configured in three phases so P200=1)
r.D.O	Rotor Diode Open	Diode failure (open)

r.D.S	Rotor Diode Short	Diode failure (short circuit)
U.V	Under Voltage	The BUS voltage is lower than the value set in parameter P.250
t.S.Er	Temperature Sensor ERror	Temperature Sensor Error
tA.L	TA loss	Amp signal loss
b.r.OH	Brake Resistor OverHeating	De-excitation resistor overheating
P.Err	Params ERror	Parameter errors with the consequent introduction of default parameters
P.F.Er	Params File ERror	Parameter file errors with the consequent introduction of default parameters
C.F.Er	Configuration File Error	

For every fault the regulator memorises a series of data in order to analyse the causes more deeply. Through parameter C.910 it is possible to set the parameter index that you want to see (for example 0 if you want to see the data of the last event), and through parameters from d.850 to d.872 the following values:

<i>Parameter</i>	<i>Description</i>	<i>Parameter that is recorded at the time of a fault</i>
d.850	Faults L	d.800
d.851	Faults H	d.801
d.852	Warnings L	d.810
d.853	Warnings H	d.811
d.854	Power on time L	d.980
d.855	Power on time H	d.981
d.856	Run time L	d.982
d.857	Run time H	d.983
d.858	Field Current	d.000
d.859	Field Voltage	d.010
d.860	Generator Voltage L1-L2	d.100
d.861	Generator Freq. Out	d.104
d.862	Generator Current	d.110
d.863	Generator Power Factor	d.111
d.864	Control Status	d.300
d.865	Control Mode	d.301
d.866	Ref	d.302
d.867	Feedback	d.303
d.868	Regulator Out	d.312
d.869	Active limits	d.330
d.870	Dig. Inputs monitor	d.400
d.871	Dig. Out monitor	d.410
d.872	DC Bus Voltage	d.999

<i>Parameter</i>	<i>Description</i>	<i>Notes</i>
C.900	Reset al. Ack	
C.910	Faults log index	Da 0 a 7 (0= last event)
C.911	Clear faults log	

4.3.6 Access control

<i>Parameter</i>	<i>Description</i>	<i>Notes</i>
C.980	Password level 1	
C.981	Password level 2	

5. REFERENCE AND REGULATORS

5.1 PWM reference (PWM)



This function mode allows controlling the command duty cycle of the IGBT.

In this case the regulator acts only on the ignition command of the IGBT, without considering what could happen externally.

This function mode could be useful during the commissioning phase of the regulator or in the case of troubleshooting.

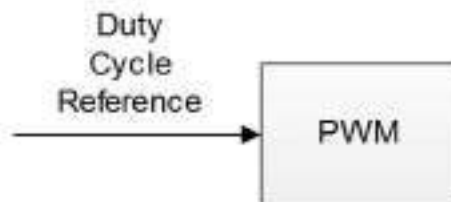

<i>Parameter</i>	<i>Description</i>	<i>Notes</i>
r.000	PWM duty reference source	0 none 1 analog input 1 2 analog input 2 3 digital
r.001	PWM reference minimum	[%]
r.002	PWM reference maximum	[%]
r.003	PWM digital reference	$r.001 < r.003 < r.002$
r.010	PWM ramp time	[s]

5.2 Field voltage reference (FVR)



This function mode allows controlling the regulator output voltage.

In this case the regulator only controls the output current to the excitation terminals of the regulator, without considering what could happen externally.

This function mode could be useful during the commissioning phase of the regulator or in the case of troubleshooting.

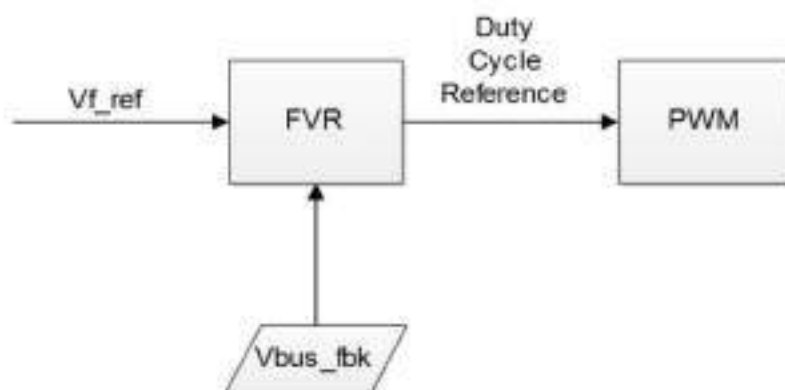

Parameter	Description	Notes
r.100	Field voltage reference source	0 none 1 analog input 1 2 analog input 2 3 digital
r.101	Field voltage reference minimum expressed in % of P.010	[%]
r.102	Field voltage reference maximum expressed in % of P.010	[%]
r.103	Field voltage digital reference expressed in % of P.010	r.101<r.103<r.102
r.110	Field voltage ramp time	[s]

5.3 Field current reference and regulator (FCR)



This function mode allows controlling the regulator output voltage.

In this case the regulator only controls the output current to the excitation terminals of the regulator, without considering what could happen externally.

This function mode could be useful during the commissioning phase of the regulator or in the case of troubleshooting.

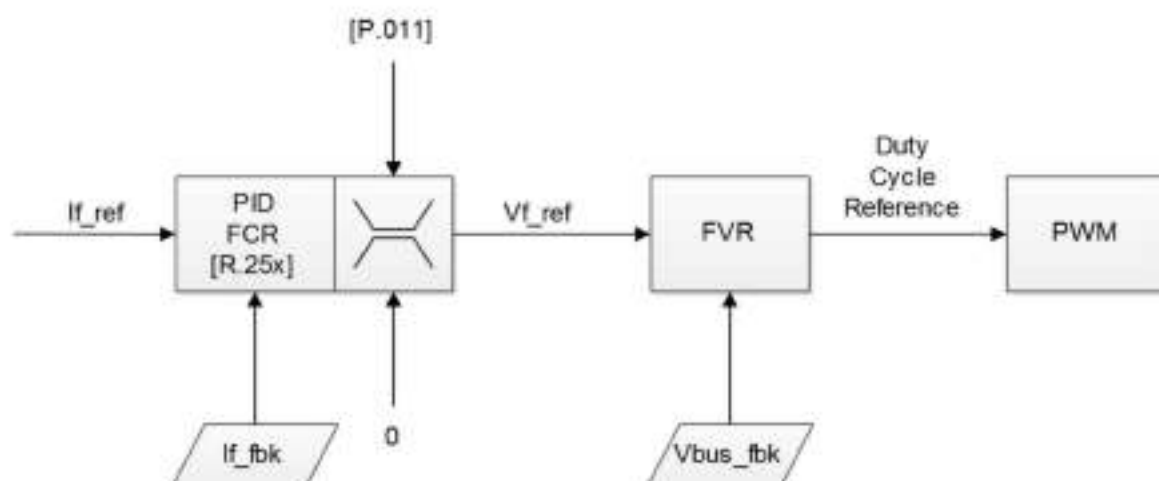

Parameter	Description	Notes
r.200	Field current reference source	0 none 1 analog input 1 2 analog input 2 3 digital
r.201	Field current reference minimum expressed in % of P.000	[%]
r.202	Field current reference maximum expressed in % of P.000	[%]
r.203	Field current digital reference expressed in % of P.000	r.201 < r.203 < r.202
r.210	Field current ramp time	[s]
r.250	Proportional gain	
r.251	Integral action time	
r.252	Derivative action time	

5.4 Generator voltage reference and regulator (AVR)

The regulator automatically controls the output voltage to the alternator terminals.

This is the principal function mode.

Given the importance, 2 controls have been set up that can be configured with different parameters in order to obtain a different response from the system according to the situation.

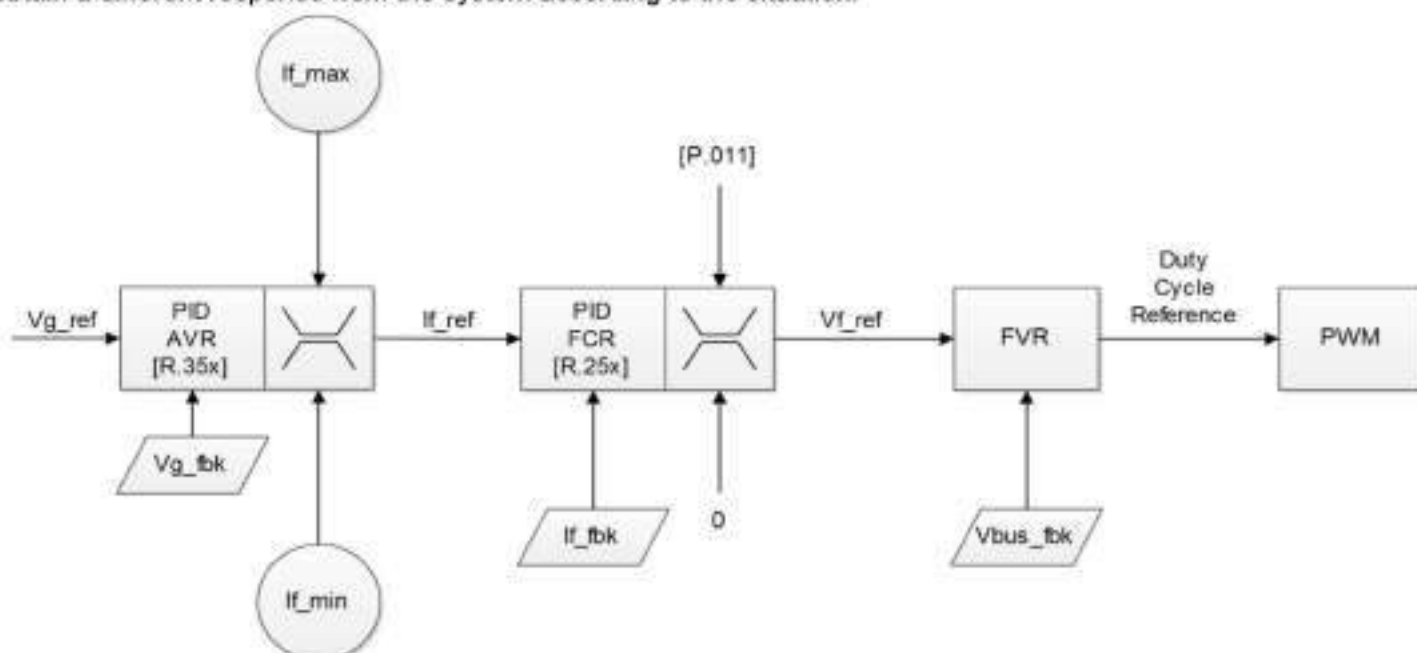

Parameter	Description	Notes
r.300	Generator voltage reference source	0 none 1 analog input 1 2 analog input 2 3 digital 4 generator rated 5 mains
r.301	Generator voltage reference minimum expressed in % of P.100	
r.302	Generator voltage reference maximum expressed in % of P.100	
r.303	Generator voltage digital reference expressed in % of P.100	
r.304	Generator voltage digital reference 1 expressed in % of P.100	
r.310	Generator voltage ramp time	
r.311	Generator voltage calibrator slope	
r.350	Proportional gain raw	
r.351	Integral action time raw	
r.352	Derivative action time raw	
r.360	Proportional gain fine	
r.361	Integral action time fine	
r.362	Derivative action time fine	
r.370	Fine gains windows expressed in % of reference	
r.380	G. V avr smpis	
r.381	G. V pb filt T	
r.382	G. V filt wind.	

5.5 Generator PF reference and regulator (PF)

The regulator automatically controls the power factor of the alternator terminals.

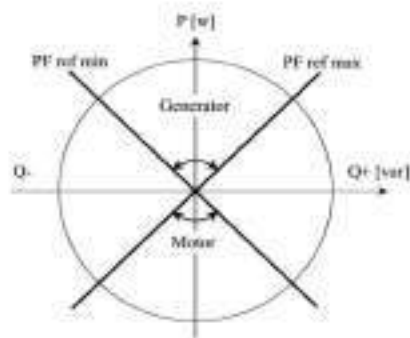
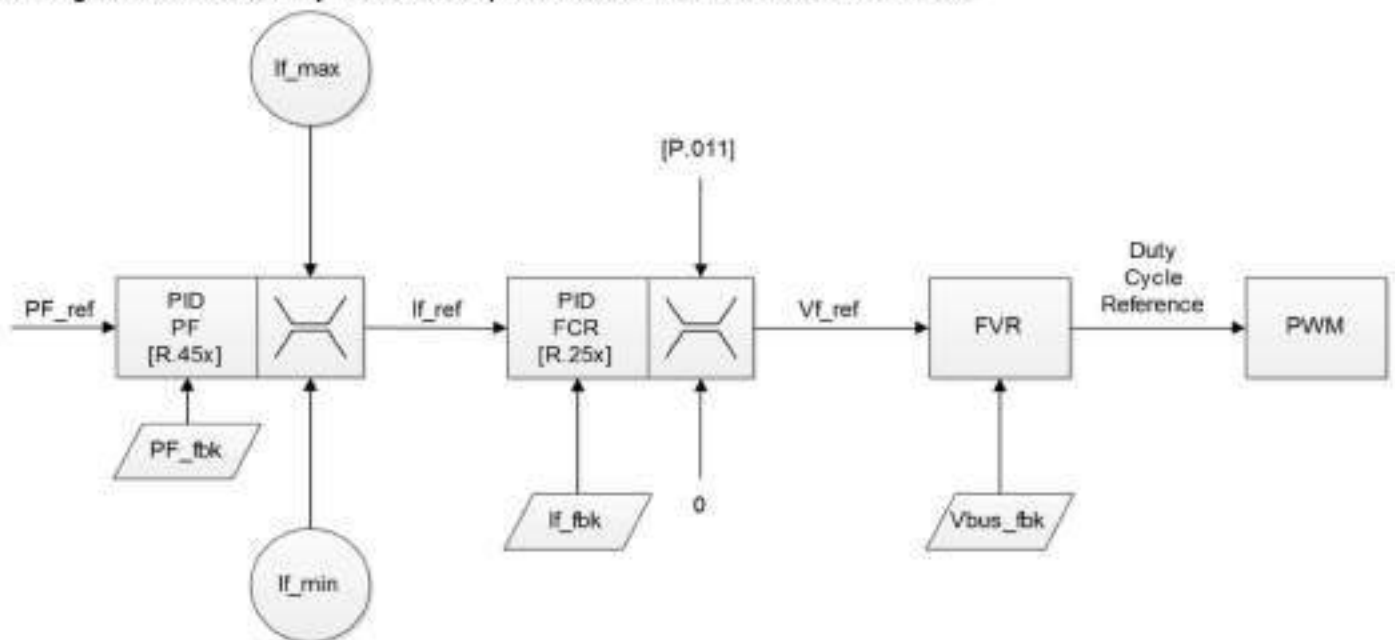

Parameter	Description	Notes
r.400	Generator PF reference source	0 None (PF=1) 1 analog input 1 2 analog input 2 3 digital
r.401	Generator PF reference minimum	
r.402	Generator PF reference maximum	
r.403	Generator PF digital reference	
r.404	Generator PF digital reference 1	
r.410	Generator PF ramp time	
r.450	Proportional gain	
r.451	Integral action time	

5.6 Generator VAR reference and regulator (VAR)

The regulator automatically controls the reactive power of the alternator terminals.

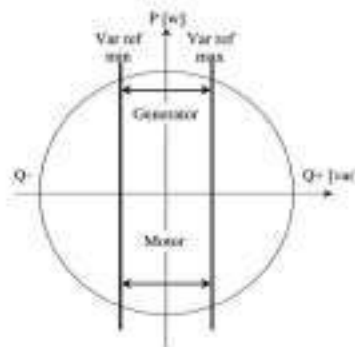
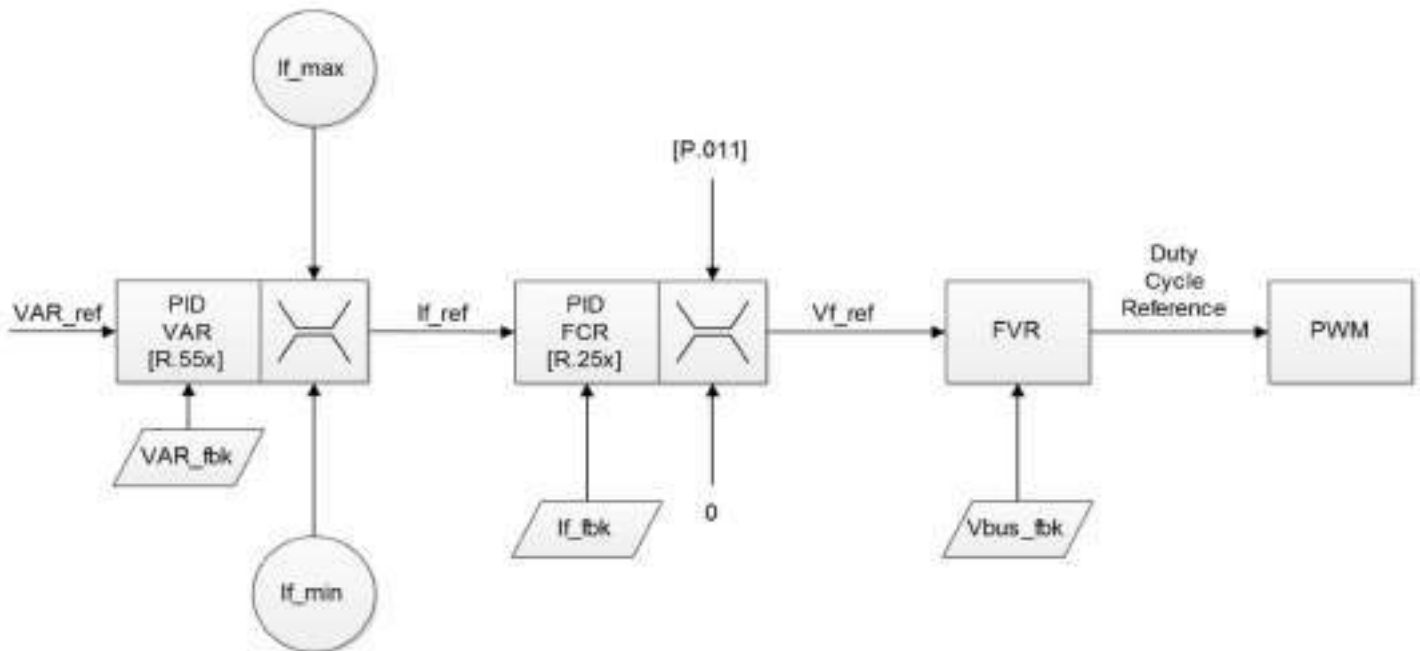

Parameter	Description	Notes
r.500	Generator VAR reference source	0 None 1 analog input 1 2 analog input 2 3 digital
r.501	Generator VAR reference minimum expressed in % of the generator rated power (P.100xP.110)	
r.502	Generator VAR reference maximum expressed in % of the generator rated power (P.100xP.110)	
r.503	Generator VAR digital reference expressed in % of the generator rated power (P.100xP.110)	
r.510	Generator VAR ramp time	
r.550	Proportional gain	
r.551	Integral action time	

5.7 Limit regulators

<i>Parameter</i>	<i>Description</i>	<i>Notes</i>
r.900	Over excitation limit regulator proportional gain	
r.901	Over excitation limit regulator Integral action time	
r.910	Under excitation limit regulator proportional gain	
r.911	Under excitation limit regulator Integral action time	

6. COMMISSIONING

6.1 Safety regulations



The S2006 operates with a dangerous voltage over 400V.

Working on live parts could cause injury to people or damage to the surrounding environment.

Potential risks can be excluded if it is operated in the correct way and following the instructions given here.

After the unit has been switched off, check that there is no voltage over 50V in the terminals.

After disconnecting the circuits, to avoid unintentional closing, it is worth identifying through warning signals, the switch points.

6.2 Connection of the Regulator

6.2.1 Power Supply

The regulator can be supplied through DC voltage, single phase AC or three-phase AC.



When ordering it should be specified the type and level of voltage on which the regulator will be operated.

Once you know the value and the type of nominal supply voltage, you can apply a simple formula to find the value to insert in P.250.

$$P.250 = k \cdot V_n$$

Where V_n is the nominal supply voltage and k can be obtained from the following table:

DC Voltage	$k=0,7$
Single phase AC Voltage	$k=1$
Three Phase AC Voltage	$k=1$

For example, suppose we had a nominal voltage of 200Vac three phase, the parameter P.250 would be set at:

$$P.250 = 1 \cdot 200 = 200$$



The regulator ignores the run command until the supply voltage reaches the value set in P.250
If the regulator is supplied by a terminal board support, it is necessary to set the parameter P.250=0

6.2.1 Voltage Signals

The regulator has 3 inputs for the alternator voltage and 2 inputs for the mains supply.

It is necessary to configure the value of the input voltage to the regulator by setting the parameter P.100 to the correct value.

If there are only two alternator voltages, set the parameter P.200=0.

6.3 Setting the Standard Parameters

In the first commissioning phase it is essential to check all the parameters.



To upload the default parameters set the parameter C.002=1

To save the parameters, set the parameter C.000=1

Standard Programming Procedure

Parameter	Description	Set Value
P.000	Nominal excitation current [0,1A]	
P.001	Over Excitation Limit	
P.002	Under Excitation Limit	
P.010	Nominal excitation current [0,1V]	
P.011	Output Voltage Limit (ceiling)	
P.100	Nominal voltage of TV of sensing alternator output	
P.101	Maximum voltage of alternator output [%P.100]	
P.110	Nominal Current of the TA of sensing alternator output [0,1 A]	
P.111	Maximum voltage of alternator output [%P.110] To disable protection set 99%	
P.120	Nominal Frequency alternator output [0.1Hz]	
P.130	Minimal frequency V/f (excitation start frequency) [%P.120]	
P.131	Maximum frequency V/f (frequency intervention "low rpm protection") [%P.120]	
P.160 P.164	Capability curve of the alternator [%P.100xP.110] (set everything at -100% to disable the limitation)	
P.200	Selection Sensing TV AC single phase/three-phase [0 single phase/1three phase]	
P.250	Nominal supply voltage [Vrms] (for precharge handling on exciters supplied independently from the alternator output)	
P.300	Predefined Control Mode	

Based on the value set in P.300 and other requirements of the application specified, the following is verified/modified:

- The parameters relative to the references in the control mode used and the gains of the associated regulators (R.xxx, usually at least R2xx, R.3xx, often also R.4xx or r.5xx)
- The parameters related to the configuration of the digital and analog inputs/outputs as well as the field bus used (i.xxx)
- Other functions like compensation or droop, series compensation, recognition faulty diodes, synchronisation, field-flashing, boost etc. on parameters P.xxx

Once calibrated save the changes using parameter C.000=1

6.4 Operations to be done while the machine is off

Preliminary Checks:

- Check the wiring comparing the connections with the electrical diagram
- Supply auxiliary voltage

- Adjust the parameters
- Check the measuring circuits for voltage and currents
- Measure the field resistance
- Adjust the limits based on the client's power diagram

6.5 Operations to be done while the machine is off

No-load Test: (rotation at nominal speed)

- Excitation and De-excitation in automatic and manual mode
- Soft start in automatic mode
- Adjust the set point range, optimise the voltage regulator
- V/Hz Limitations

Load Test:

- Measure the stator current, measure the active and reactive power, eventual droop or compensation
 - Test the limit of over excitation and under excitation
 - Optimise the limits of the maximum and minimum excitation current
 - Optimise the limits of the maximum and minimum reactive current
- The setting of the PQ limits must be coordinated with the protections of the alternator. Usually the regulator limit should be set at least 5% less.

7. MAINTENANCE AND BREAKDOWN



Before carrying out any procedure on the voltage regulator it is necessary to cut the current and apply protective earthing equipment

7.1 Maintenance

When the system is off it is necessary to check the screw terminals that, due to vibrations, could be loose. Monthly check that the cooler is not dusty. Clean using a dry cloth or vacuum cleaner.

7.2 Problem Solving

The following instructions can be used to help locate a fault in the excitation system.

List of Possible Faults

Possible Causes	Checks
The machine does not start up	
<ul style="list-style-type: none"> Field circuit broken Field switch open 	<ul style="list-style-type: none"> Check the wiring Check the state of the field switch
<ul style="list-style-type: none"> The field flashing does not work 	<ul style="list-style-type: none"> Check the field flashing circuit
<ul style="list-style-type: none"> No supply of the U_{ALX} electronics 	<ul style="list-style-type: none"> Measure the auxiliary voltage UAUX Verify any release of the protective switch
<ul style="list-style-type: none"> No supply of the U_{PWR} power 	<ul style="list-style-type: none"> Measure the voltage of the UOWR power circuit Verify any release of the protective switch
<ul style="list-style-type: none"> The machine is only energised by field flashing The machine is energised and de-energised 	<ul style="list-style-type: none"> Measure the control and power supply voltage Check the level of output of the field flashing phase Check the function mode. Field flashing is normally used automatically Check the level of output of the field flashing phase Check the set point Measure the control and power supply voltage
Over Voltage During Start up	
<ul style="list-style-type: none"> Over voltage caused by the regulator Field Flashing current too high 	<ul style="list-style-type: none"> Measure the alternator voltage at the regulator voltage inputs Check the configuration data Check the function mode Check the set point and the settings Check the voltage threshold limit Check the field flashing circuit. Field flashing should supply a current value equal to 10+15% of the excitation current in a no-load operation.
The machine voltage is not stable during the no-load operation	

Possible Causes	Checks
<ul style="list-style-type: none"> • Regulation Errors 	<ul style="list-style-type: none"> • Check the function mode • Check the set point • Check the automatic regulator parameters
<ul style="list-style-type: none"> • Set point Error 	<ul style="list-style-type: none"> • Up/down input unstable • External input unstable
<ul style="list-style-type: none"> • Breakdown of and element 	<ul style="list-style-type: none"> • Check the wiring, verify the input voltage, verify the output current
Parallel Function with unstable network. Periodic oscillations of the reactive and possibly active power	
<ul style="list-style-type: none"> • Incorrect regulator setting 	Changes have been made to the network configuration? <ul style="list-style-type: none"> • Yes: reset the regulator • No: check the parameters of the function mode selected
Irregular instability, sporadic over or under excitation not caused by the network	
<ul style="list-style-type: none"> • The influence of the Droop on the voltage regulator is ineffective or TA is defective 	<ul style="list-style-type: none"> • Check the droop or compensation set • Check the TA external circuit • Alert that the machine switch is not active
<ul style="list-style-type: none"> • Machine functioning outside its admissible range (normally protected by limits) 	<ul style="list-style-type: none"> • Take the machine to a normal operating range regulating the set point • Check the limits set
The operating point cannot be reached	
<ul style="list-style-type: none"> • Set point Error 	<ul style="list-style-type: none"> • Check the function mode • Check set point
<ul style="list-style-type: none"> • Limit active 	<ul style="list-style-type: none"> • Take the machine to a normal operating range regulating the set point • Check the limits set
Excitation of the machine is only supplied by the boost circuit <ul style="list-style-type: none"> • There is no voltage in the power unit 	<ul style="list-style-type: none"> • Measure the control and power supply voltage • Verify any release of the protective switch • Check the function mode • Check the set point • Check the automatic regulator parameters
<ul style="list-style-type: none"> • Regulation Error 	

8. GENERAL DATA

Information

Device: S2006

Order code	
S2006	/ / / / /

Excitation current	
$I_{EN} \leq 5A$	05
$I_{EN} \leq 10A$	10
$I_{EN} \leq 15A$	15
$I_{EN} \leq 25A$	25
$I_{EN} \leq 40A$	40
Without tin bead	Z
CB Version	XX

Power electronics supply	
$<240V_{AC}$ o $<340V_{CC}$	L
$>240V_{AC}$ o $>340V_{CC}$	H

Auxiliary supply	
Not present	Z
Present	B

Ethernet communication	
Not present	Z
Present	Y

Digital I/O	
10 I/O	10
16 I/O	16

8.1 S2006 up to 15A

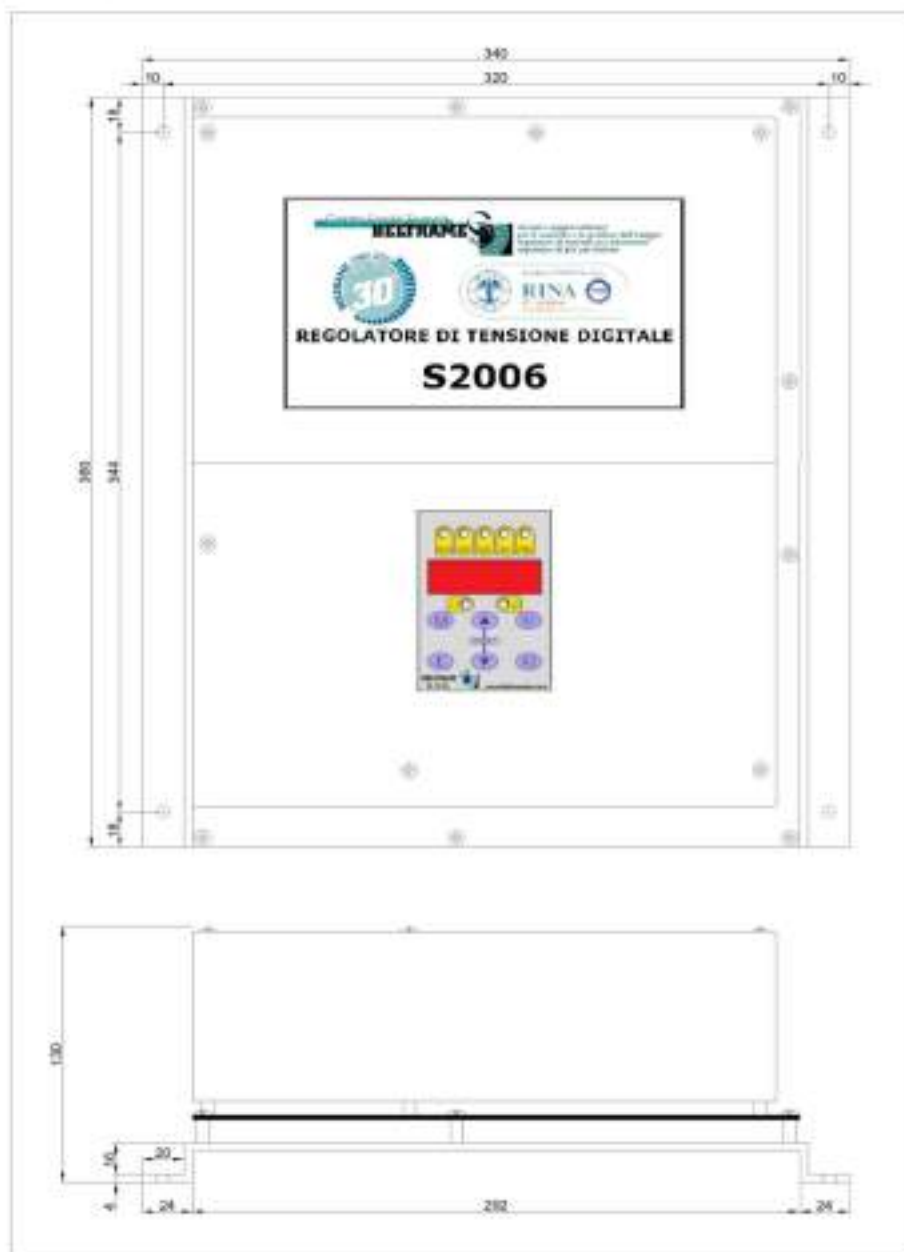

Mechanical data

Weight \approx 5,6 kg

Protection class IP20

Dimensions (LxBxH) 380x340x130 mm

Climate stability

Operating temperature $0 + 60^{\circ}\text{C}$

Storage temperature $-20 + +75^{\circ}\text{C}$

Electrical data

Auxiliary supply U_{AUX} : Max power 25W

Power electronics supply U_{PWR} : DC or AC (from 40 to 600 Hz)

Excitation current 15 A

Overload 200% for 10s

Overload 150% for 4min

Current reduction for ambient temperatures $>50^{\circ}\text{C}$ 1 A /degree

8.2 S2006 up to 25A

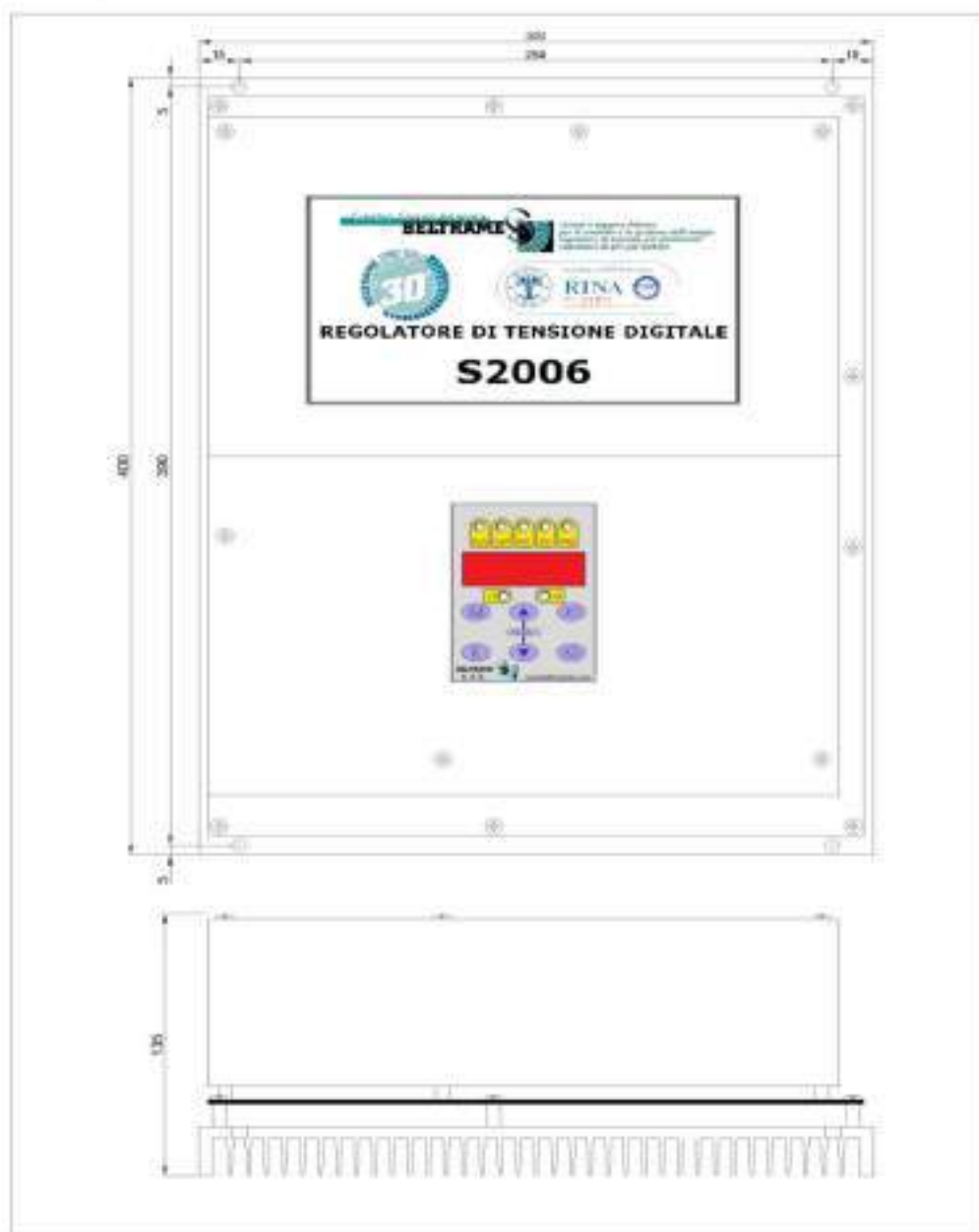

Mechanical data

Weight \cong 7,5 kg

Protection class IP20

Dimensions (LxBxH) 400x300x135 mm

Climate stability

Operating temperature 0 + 60°C

Storage temperature -20 + +75°C

Electrical data

Auxiliary supply U_{AUX} : Max power 25W

Power electronics supply U_{PWR} : DC or AC (from 40 to 600 Hz)

Excitation current 25 A

Overload 200% for 10s

Overload 150% for 4min

Current reduction for ambient temperatures >50 °C 1 A /degree

8.3 S2006 up to 40A

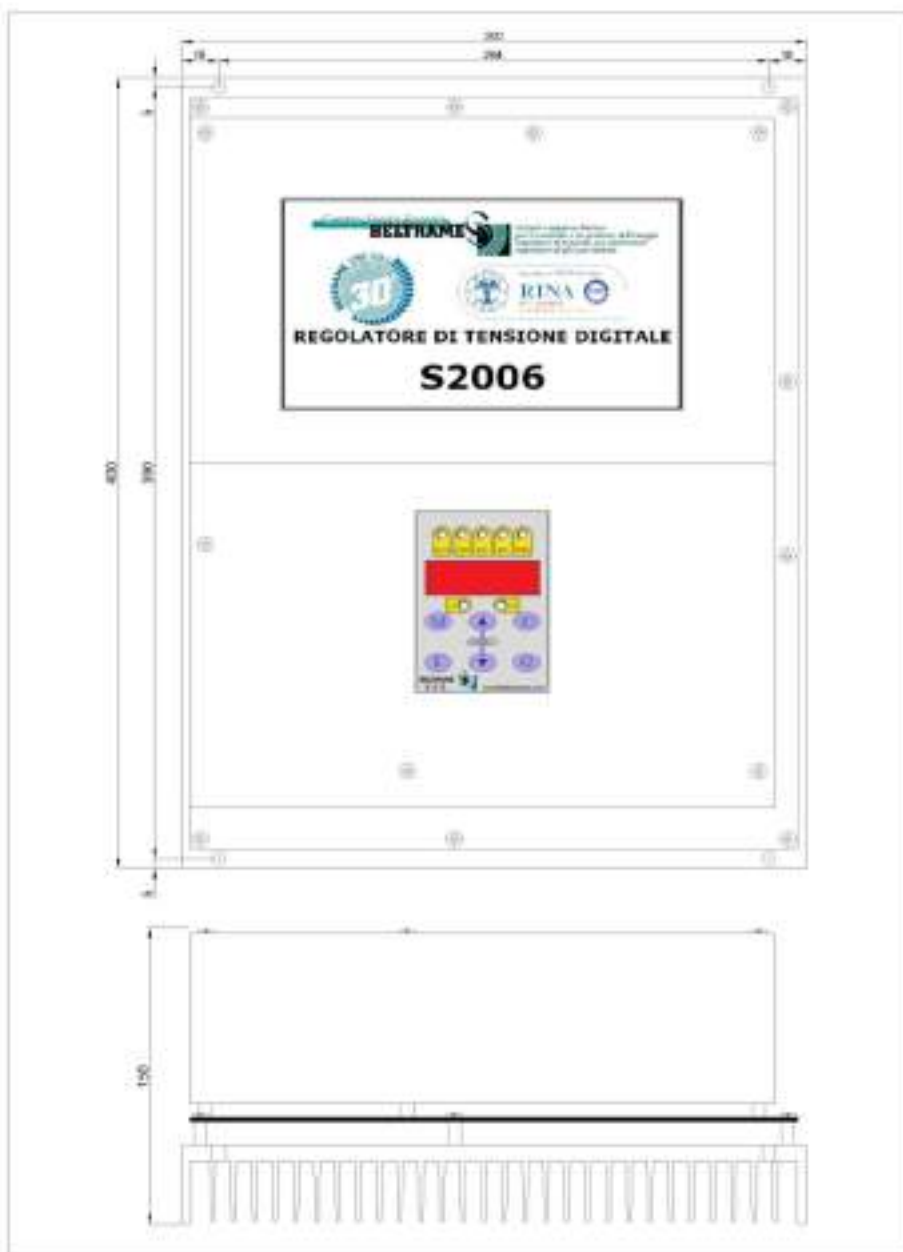

Mechanical data

Weight \approx 9,5 kg

Protection class IP20

Dimensions (LxBxH) 400x300x150 mm

Climate stability

Operating temperature 0 + 60°C

Storage temperature -20 + +75°C

Electrical data

Auxiliary supply U_{AUX} : Max power 25W

Power electronics supply U_{PWR} : DC or AC (from 40 to 600 Hz)

Excitation current 40 A

Overload 150% for 10s

Current reduction for ambient temperatures >50 °C 1 A /degree