

21

A

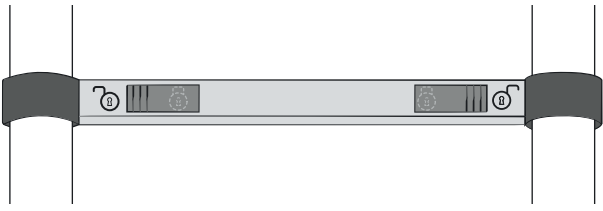

B

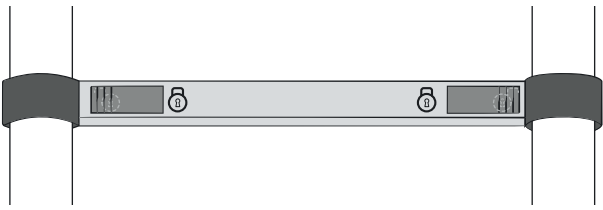

23

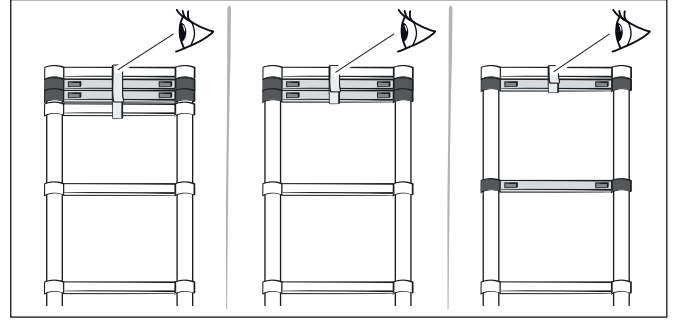
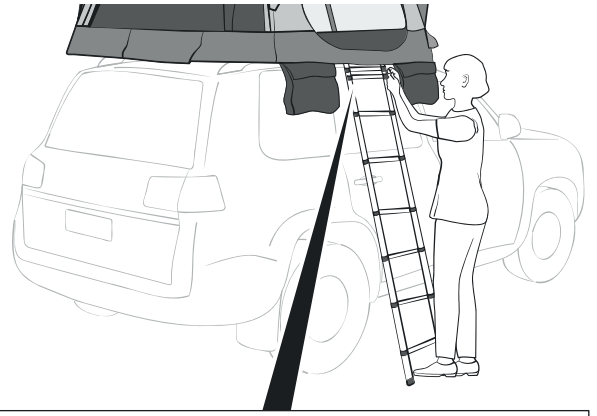

22

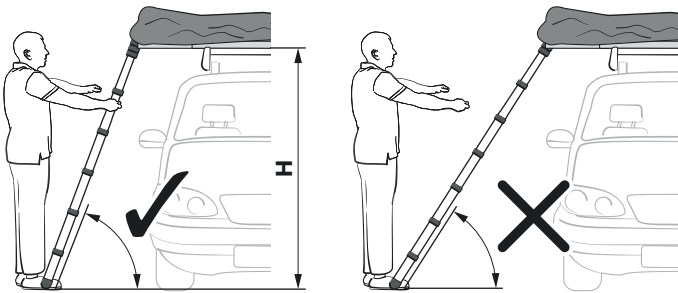

H

160 cm
(5'3")

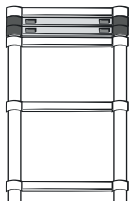

160 – 180 cm
(5'3" – 5'11")

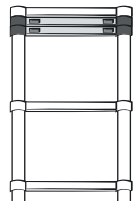

180 – 200 cm
(5'11" – 6'7")



200 cm
(6'7")

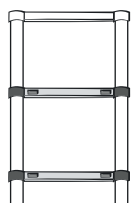

24

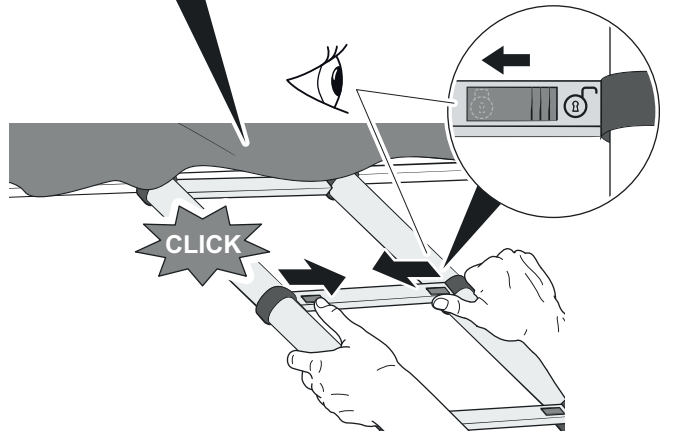
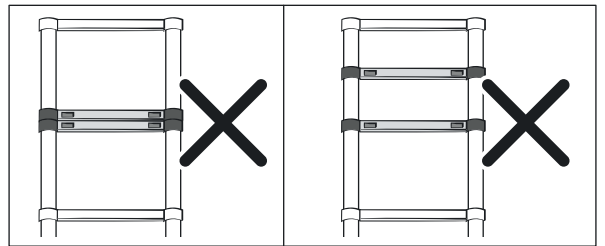

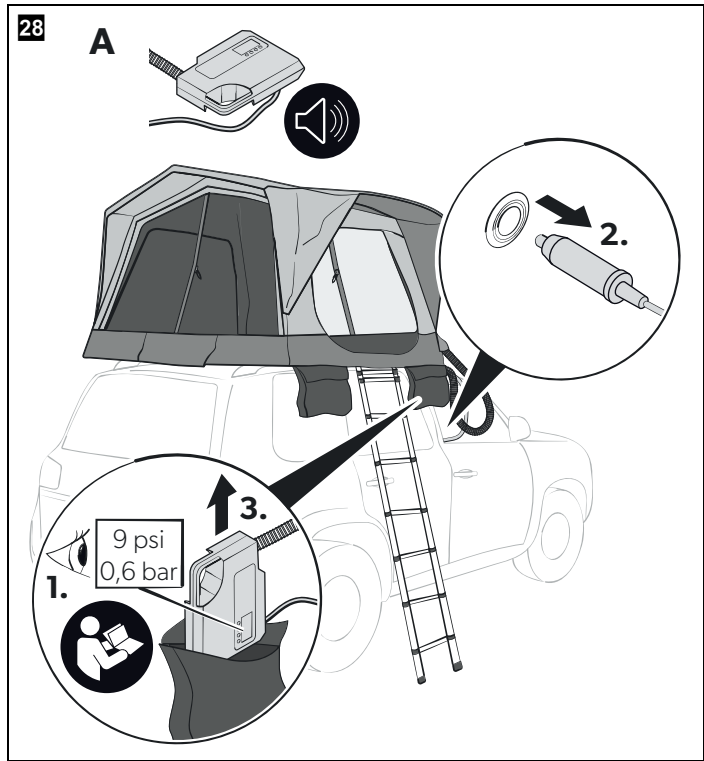
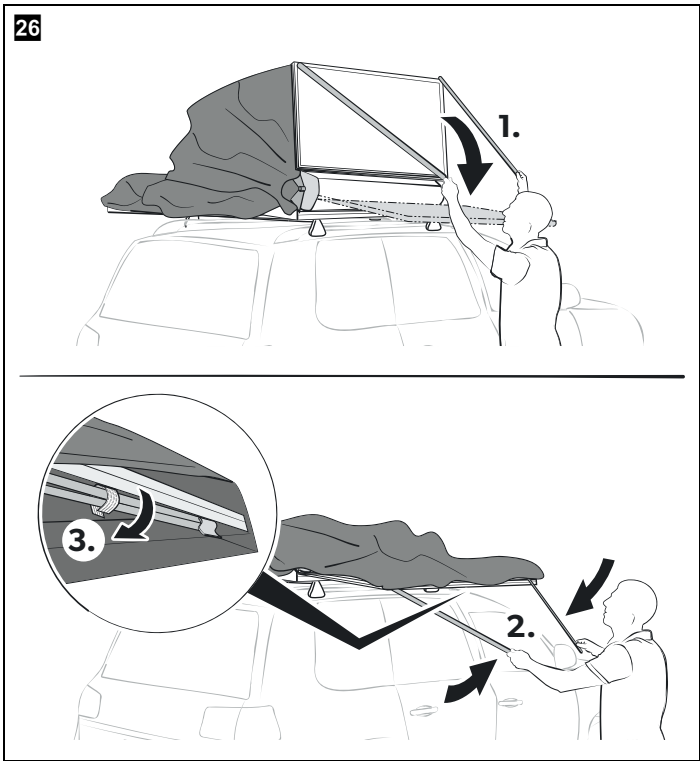
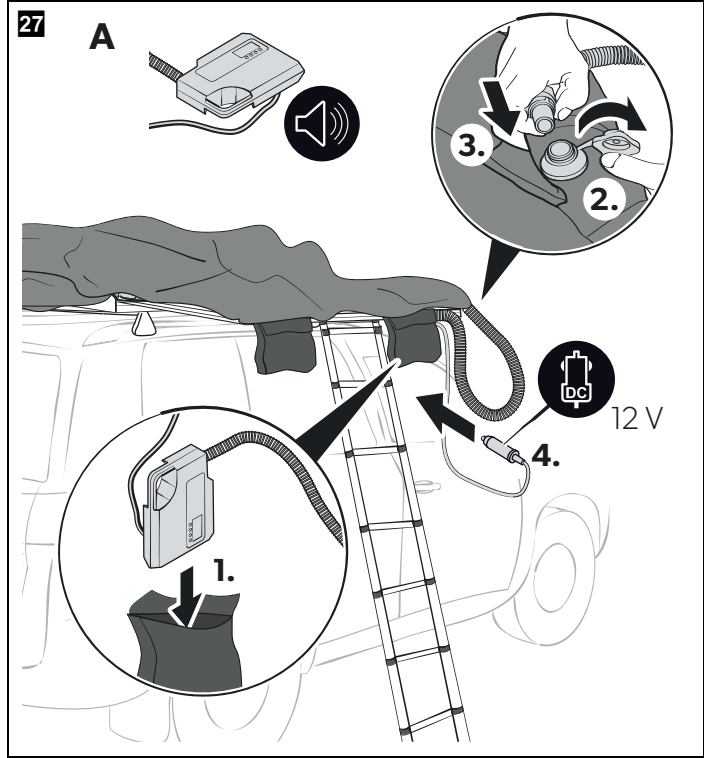
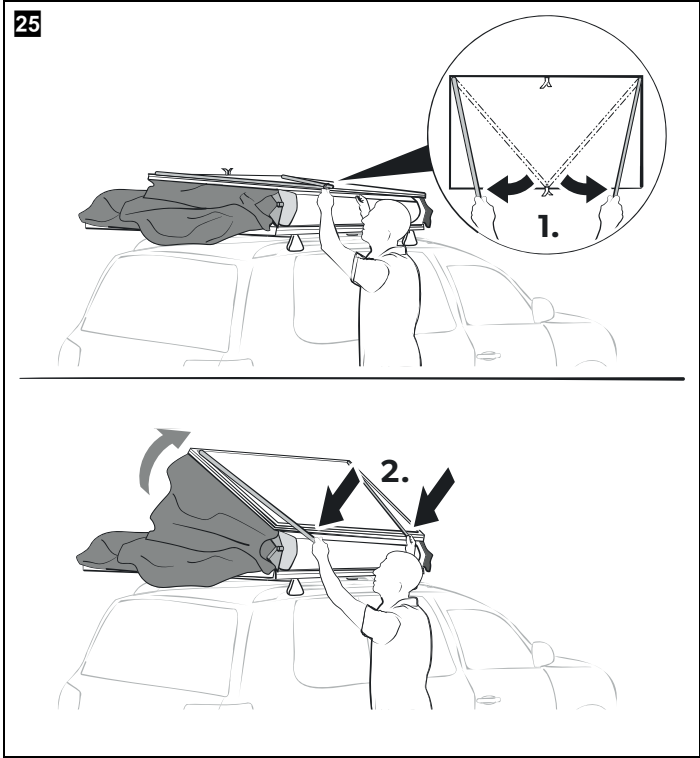

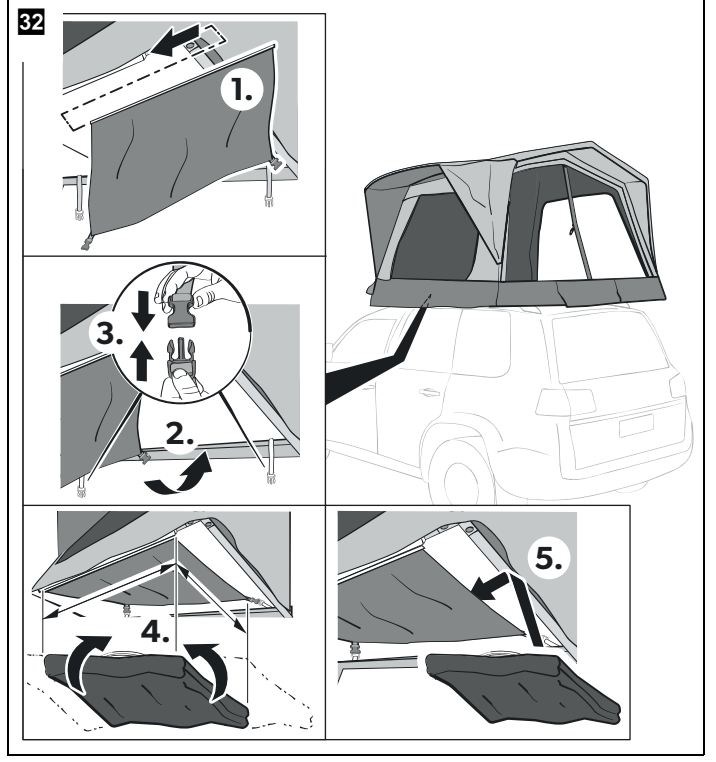
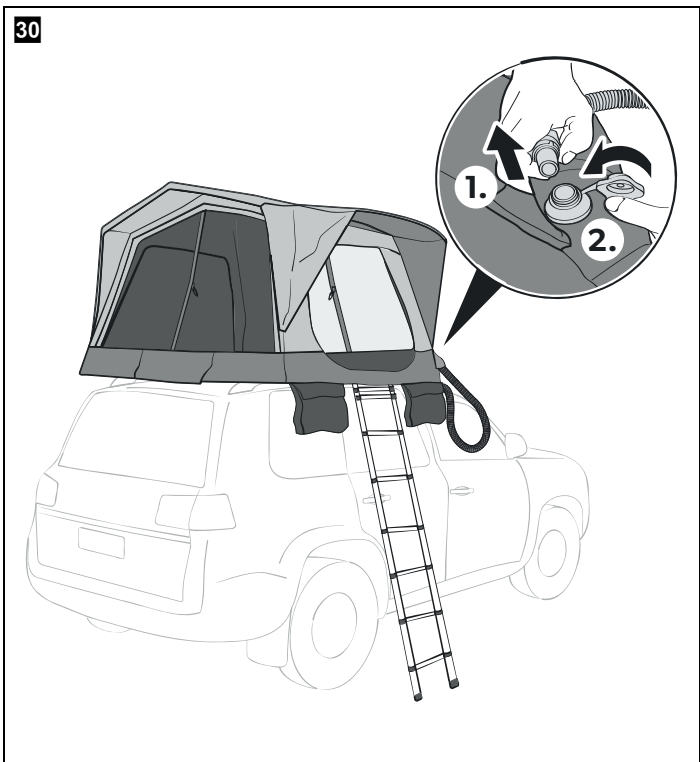
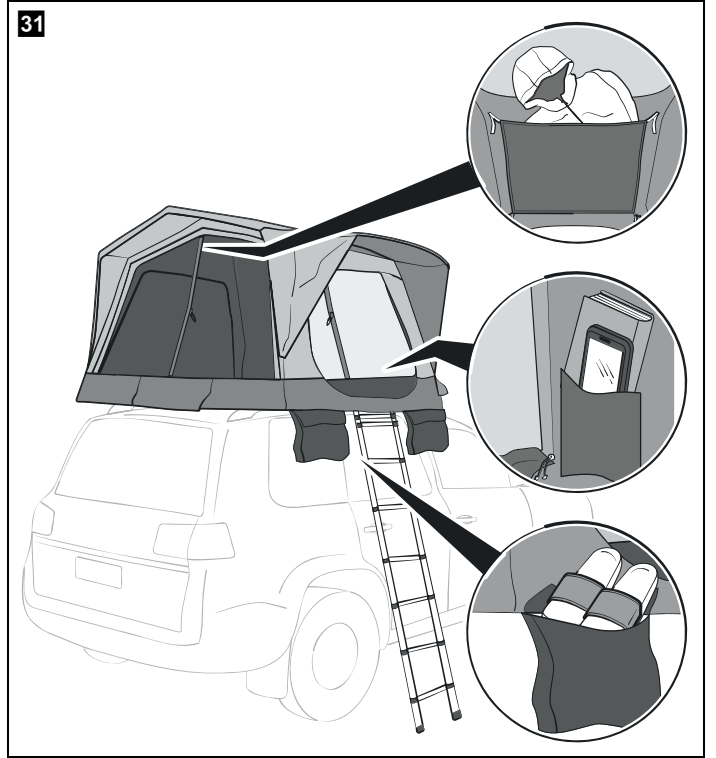
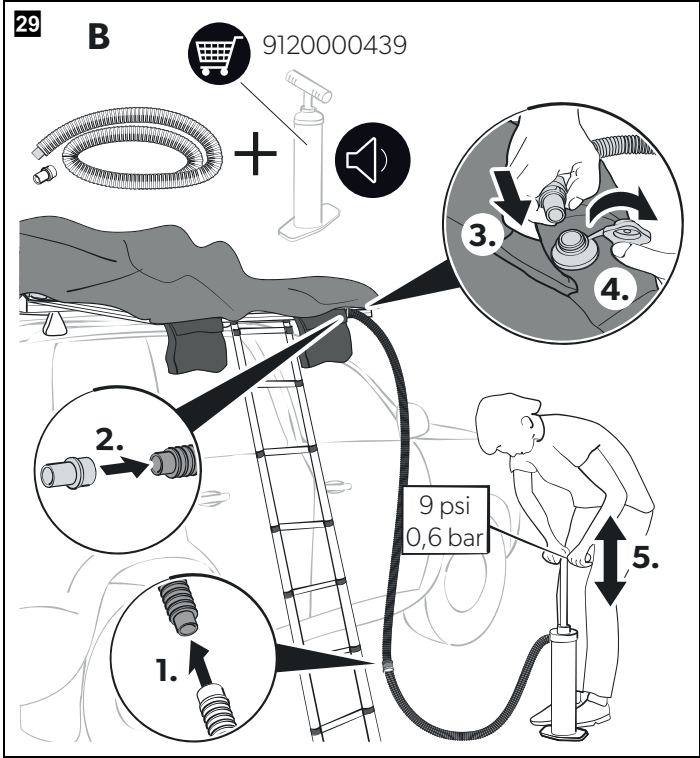

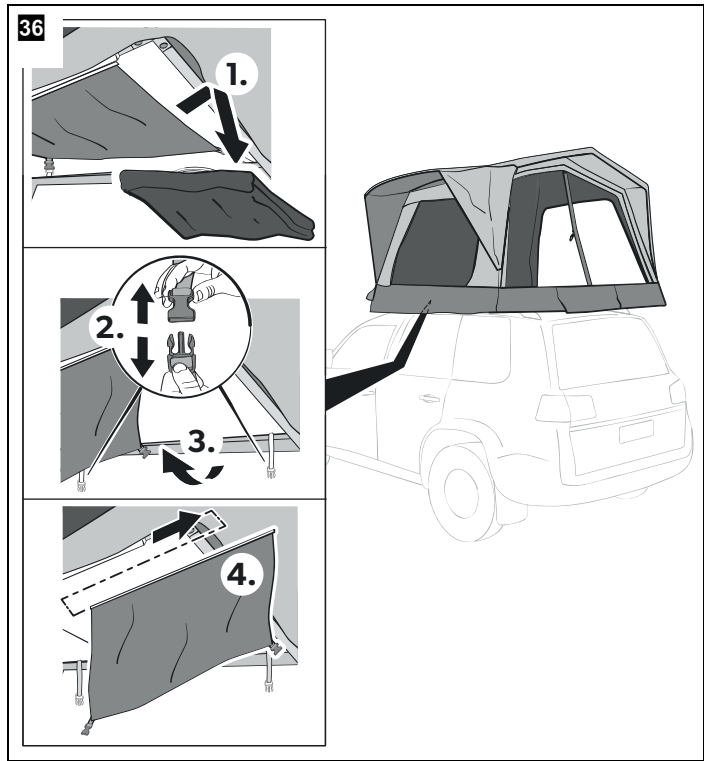
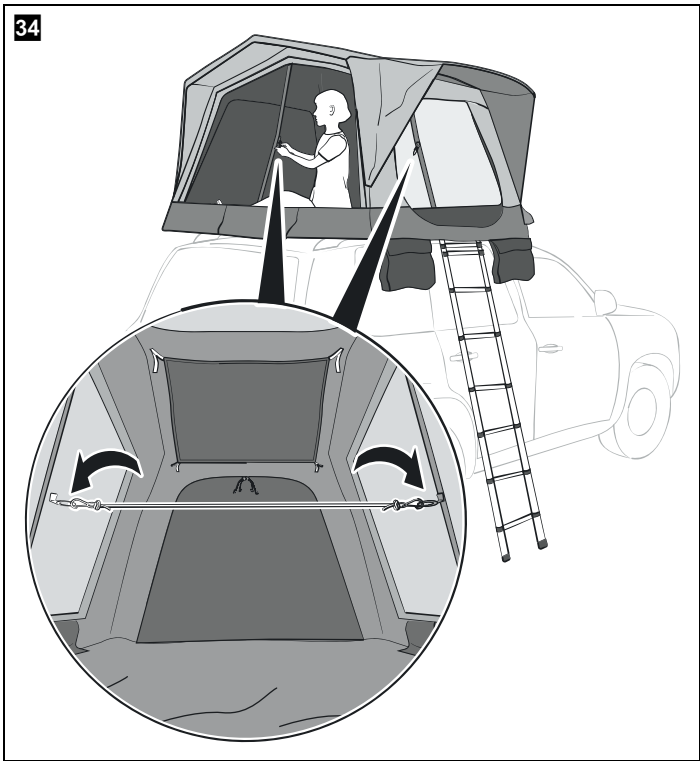
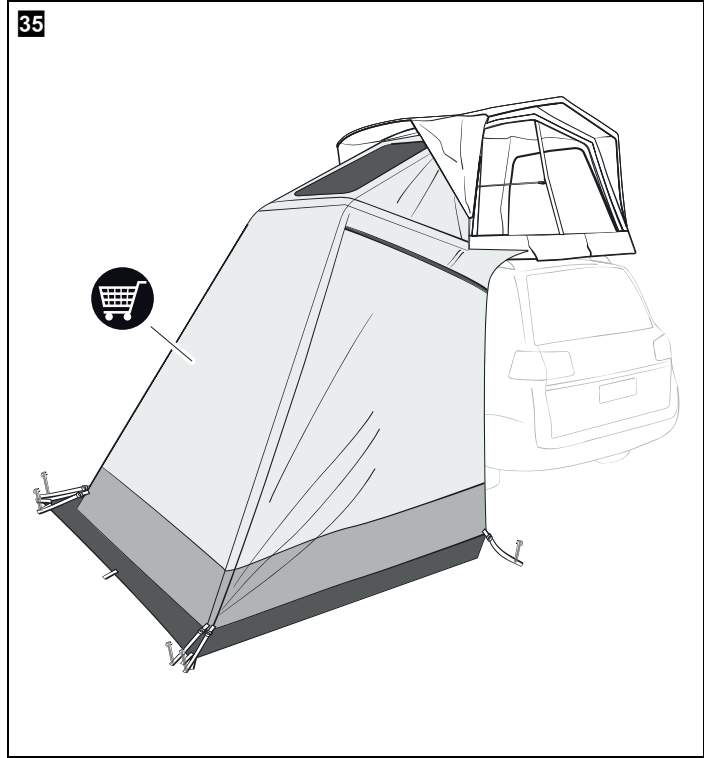
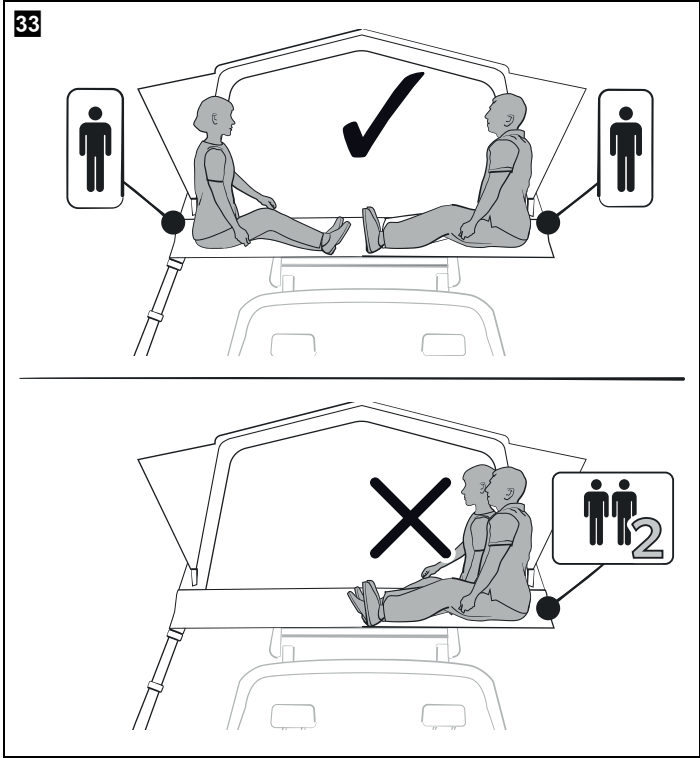

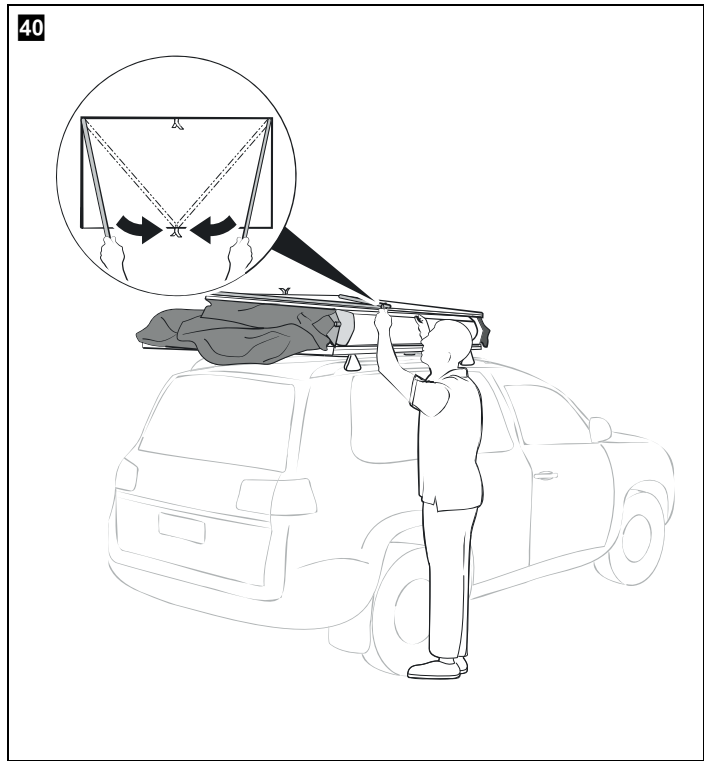
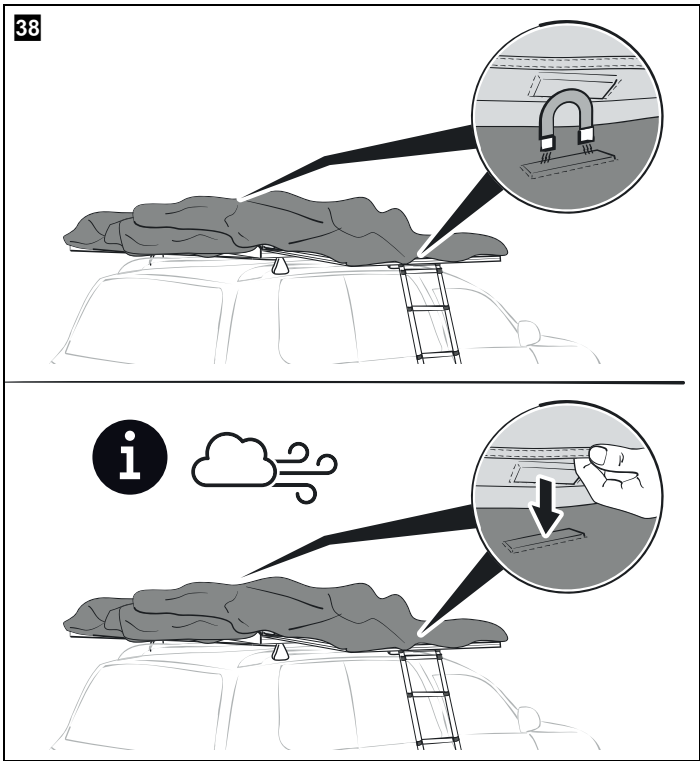
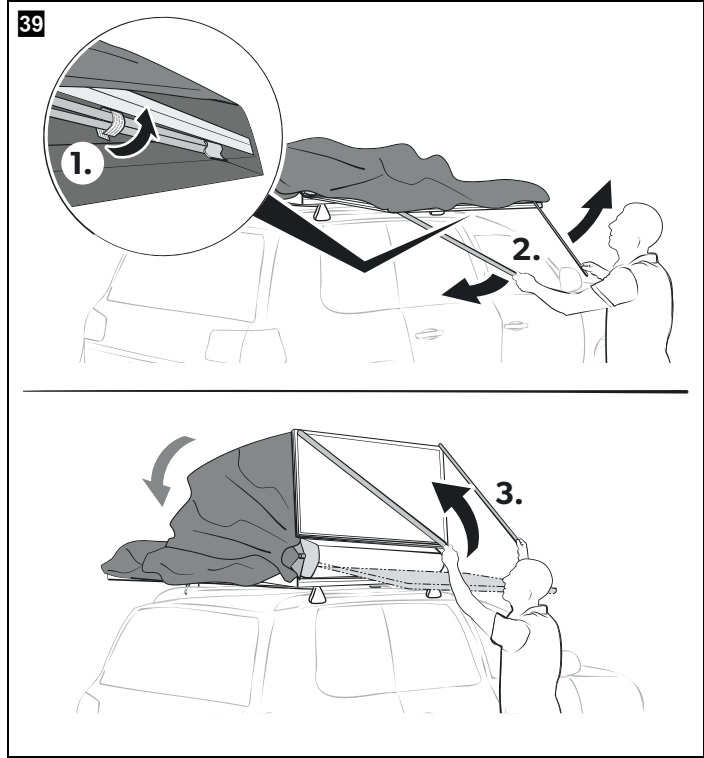
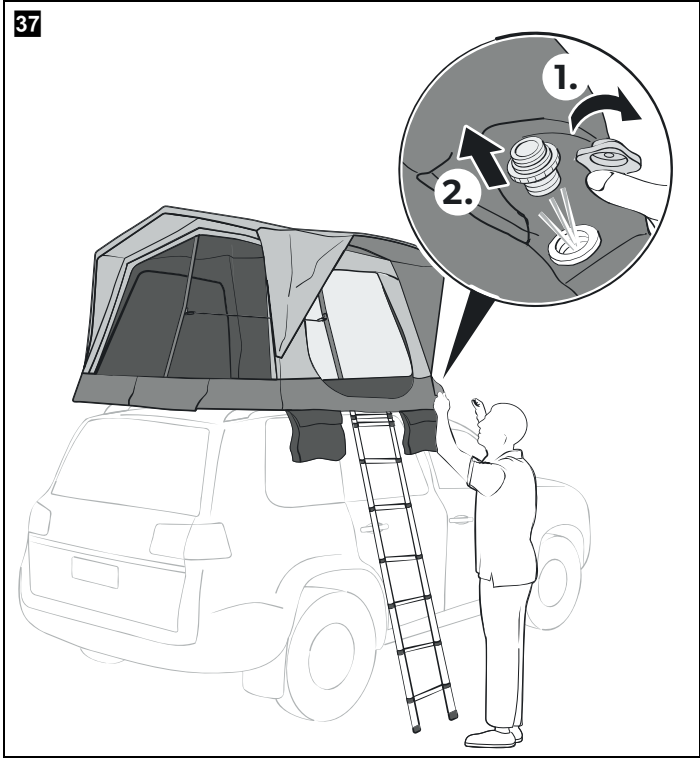

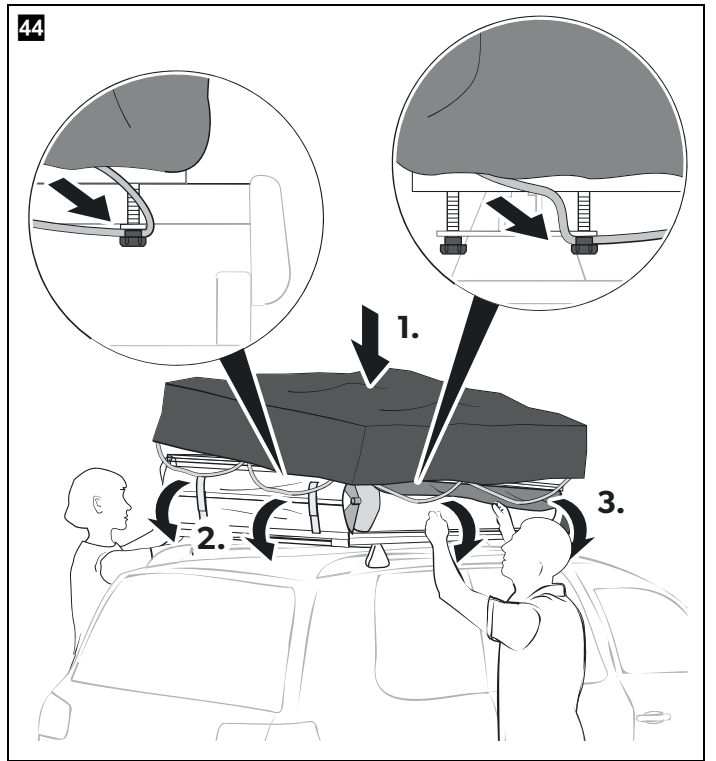
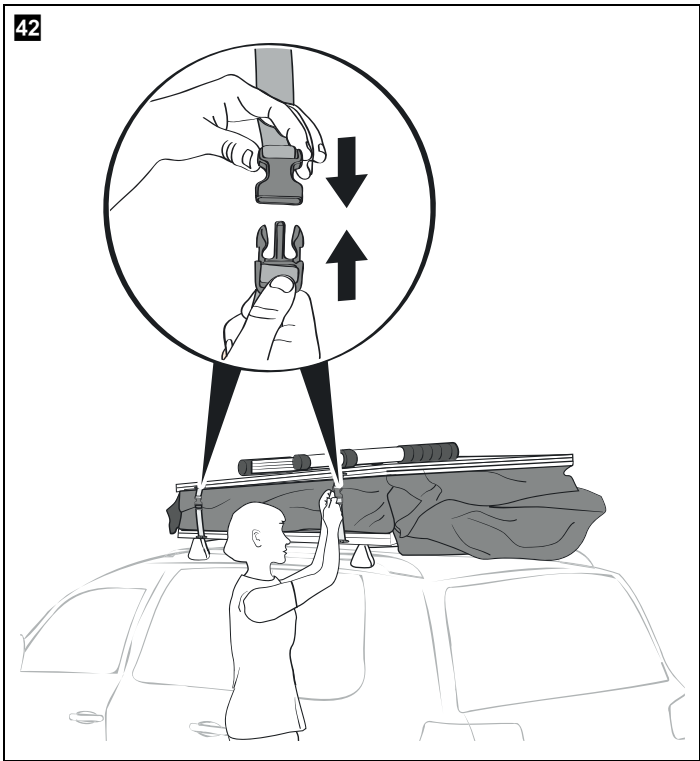
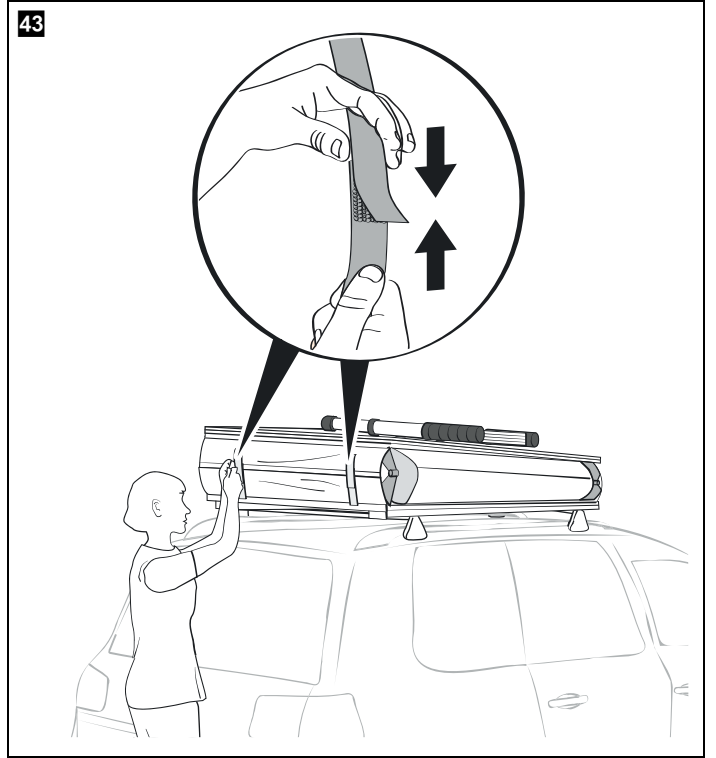
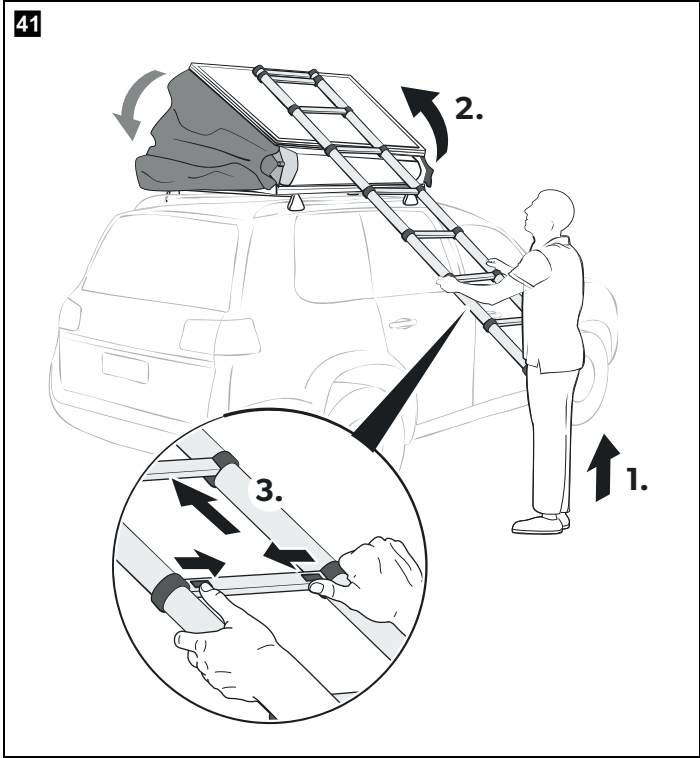

45

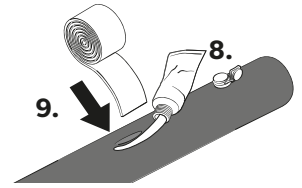
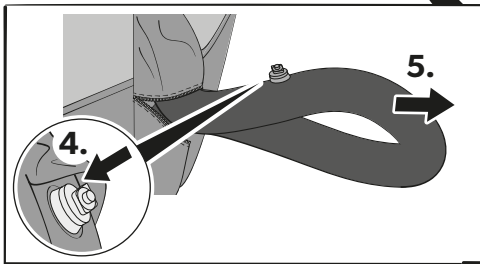
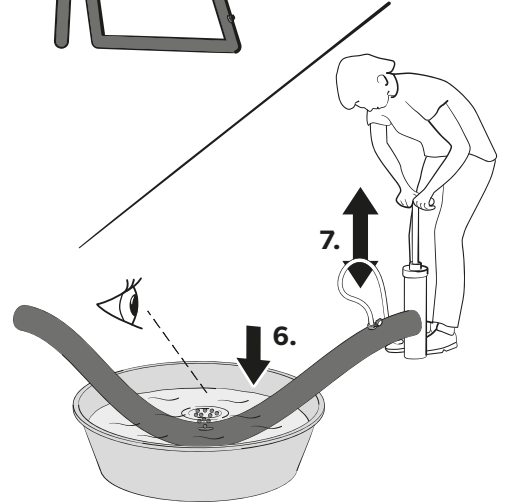
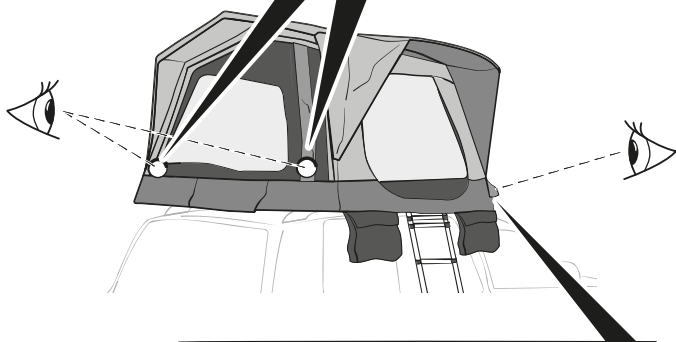
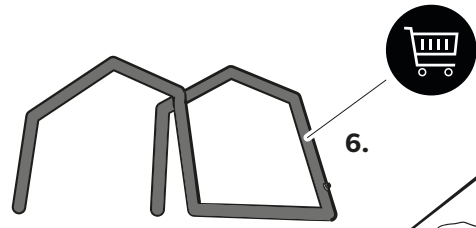
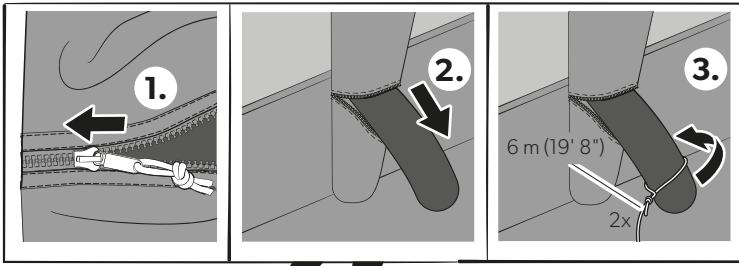

46

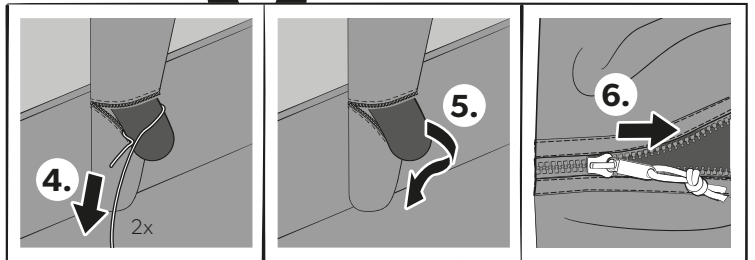
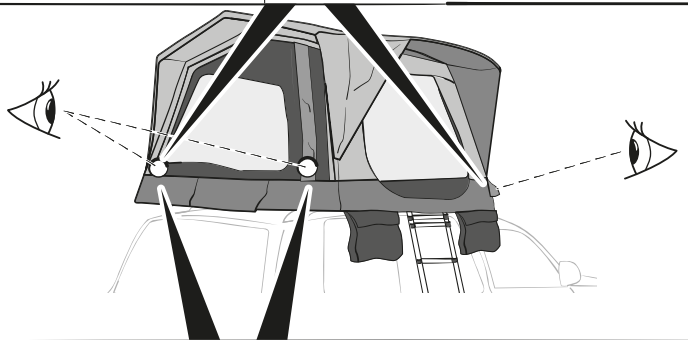
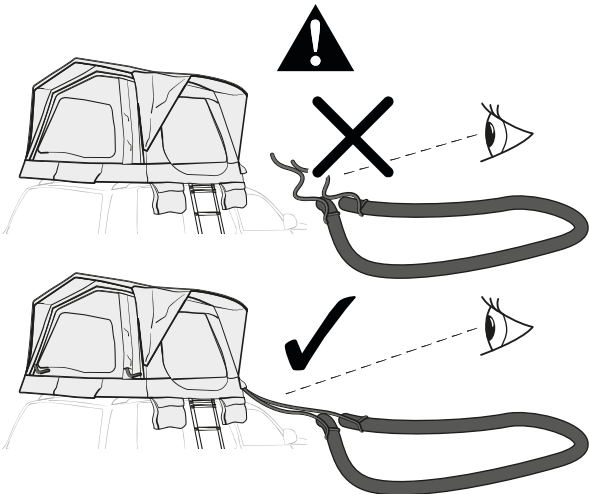
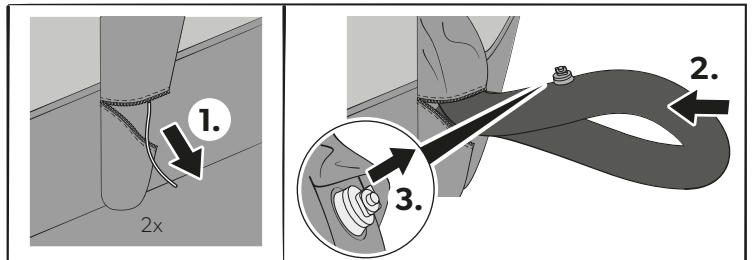

Please read these instructions carefully and follow all instructions, guidelines, and warnings included in this product manual in order to ensure that you install, use, and maintain the product properly at all times. These instructions MUST stay with this product.

By using the product, you hereby confirm that you have read all instructions, guidelines, and warnings carefully and that you understand and agree to abide by the terms and conditions as set forth herein. You agree to use this product only for the intended purpose and application and in accordance with the instructions, guidelines, and warnings as set forth in this product manual as well as in accordance with all applicable laws and regulations. A failure to read and follow the instructions and warnings set forth herein may result in an injury to yourself and others, damage to your product or damage to other property in the vicinity. This product manual, including the instructions, guidelines, and warnings, and related documentation, may be subject to changes and updates. For up-to-date product information, please visit documents.dometic.com, dometic.com.

Explanation of symbols



DANGER!

Safety instruction: Indicates a hazardous situation that, if not avoided, will result in death or serious injury.



WARNING!

Safety instruction: Indicates a hazardous situation that, if not avoided, could result in death or serious injury.



CAUTION!

Safety instruction: Indicates a hazardous situation that, if not avoided, could result in minor or moderate injury.



NOTICE!

Indicates a situation that, if not avoided, can result in property damage.



NOTE

Supplementary information for operating the product.

General safety instructions



DANGER! Failure to obey this instruction will cause death or serious injury.

Hazard of carbon monoxide poisoning

- Never use a fuel-burning appliance such as barbecues or gas heaters inside the tent. The burning process produces carbon monoxide which accumulates inside the tent as there is no flue.



WARNING! Failure to obey these warnings could result in death or serious injury.

Fire hazard

- Ensure to know the fire precaution arrangements on the site.
- Do not cook inside the tent or use open flames.
- Keep all flame and heat sources away from this tent fabric.

Beware of suffocation

- Ensure ventilation openings are open all the time to avoid suffocation.

Risk of injury

- This device is not intended for use by persons (including children) with reduced physical, sensory or mental capabilities.
- Do not allow children to play around or in the tent and ensure that they are careful when using the ladder.
- Cleaning and user maintenance may not be carried out by unsupervised children.

- Always check the weather forecast before set up and use of the rooftop tent.
 - Do not use the rooftop tent if a storm or a thunderstorm is announced.
 - If getting caught in a thunderstorm, immediately leave the rooftop tent and get yourself to safety in your vehicle. Stay in your vehicle until the thunderstorm is over to avoid being struck by lightning.
 - Do not set up, use or fold down the rooftop tent or the ladder if it is very windy.
 - Do not fold down the rooftop tent during heavy rain.
- Do not use the rooftop tent if any part or any of its components are visibly damaged. Contact the manufacturer for assistance.
- Only use tested (e.g. GS-tested) roof racks that are approved for use with your vehicle.
- Before mounting the rooftop tent, make sure that your vehicle and your roof rack offer sufficient load capacity for the rooftop tent and the persons and objects intended to be inside the rooftop tent.



NOTE

- Always keep the vehicle and roof rack manuals with you and follow their instructions.

Safety when using the ladder



CAUTION! Failure to obey these cautions could result in minor or moderate injury.

Risk of injury

- After delivery and before every use, check that the ladder is not damaged and is safe to use. Do not use a damaged ladder.
- There is a risk of falling during ascent, descent and general use of the ladder. The use of the ladder must be carried out in such a way that the risk of falling is kept as low as possible.
 - Keep a secure grip on the ladder.
 - Do not lean out to the side.
 - Only ascend and descend facing the ladder.
- Do not enter the ladder with more than one person at a time.
- Do not erect the ladder on an uneven, unstable or contaminated ground.
- Do not carry equipment which is heavy or difficult to handle while using the ladder.
- Do not wear unsuitable footwear when climbing the ladder.
- Do not use a ladder that is soiled, e.g. by mud or snow.
- Do not use the ladder in case of physical limitations. Certain health conditions, medication use, alcohol or drug abuse may cause a safety risk when using the ladder.
- Ensure that the locking mechanisms for all extended segments are locked before transport, each use and storing of the ladder.
- When setting up and using the ladder, be aware of the risk of collisions, e.g. with pedestrians, vehicles or doors. Close doors (except emergency exits) and windows in the area of use, if possible.
- Do not modify the ladder or any of its components in any way.



NOTICE! Damage hazard

- Observe the specified maximum total load of the ladder.

Safety when transporting the rooftop tent on the rooftop of a vehicle



WARNING! Failure to obey these warnings could result in death or serious injury.

Risk of injury

- Only drive with the rooftop tent on the rooftop of your vehicle if the rooftop tent is folded down and covered correctly with the tent cover.
- Do not drive faster than 110 km/h (88 mph) with the rooftop tent on the rooftop of your vehicle.
- At the beginning of each trip and at regular intervals during each trip, check that the rooftop tent is firmly attached to the roof rack and that the tent cover is safely secured. An incorrectly mounted roof rack or rooftop tent can fall off during the journey and injure other road users.
- Store the ladder correctly on top of the folded rooftop tent and under the tent cover to prevent the ladder from falling off and injuring other road users during the journey.
- Adjust your driving behavior (e.g. crosswind sensitivity, cornering, and braking behavior) to accommodate the change in vehicle height.



NOTICE! Damage hazard

- The rooftop tent increases the vehicle height. Beware of low entrances, low bridges, low hanging branches and other obstacles.
- Remove the rooftop tent and the roof rack when using an automatic car wash.



NOTE

- Wind noise may occur when driving with the rooftop tent on the rooftop of a vehicle.

Safety when operating the Gale 12V electric pump



WARNING! Failure to obey these warnings could result in death or serious injury.

Electrocution hazard

- Do not operate the electric pump if it is visibly damaged.
- If this electric pump's power cable is damaged, it must be replaced by the manufacturer, a service agent or a similarly qualified person in order to prevent safety hazards.
- This electric pump may only be repaired by qualified personnel. Improper repairs can lead to considerable hazards.
- Do not use the electric air pump in wet conditions or submerge in any liquid. Store in a dry place.



CAUTION! Failure to obey these cautions could result in minor or moderate injury.

Electrocution hazard

- Before starting the electric air pump, ensure that the power cable and the plug are dry and the plug is free of rust or foreign matter.
- Disconnect the electric air pump from the power supply
 - Before each cleaning and maintenance
 - After every use

Risk of injury

- This device is not intended for use by persons (including children) with reduced physical, sensory or mental capabilities, or lack of experience and knowledge, unless they have been given supervision or instruction concerning use of the device by a person responsible for their safety.
- Keep children and pets away from the electric pump whilst operation.
- Do not direct air stream at face or body.
- Observe the recommended air pressure.



NOTICE! Damage hazard

- Cleaning and user maintenance may not be carried out by unsupervised children.
- Check that the voltage specification on the data plate corresponds to that of the energy supply.
- Only connect the electric pump to a DC power supply in the vehicle with the DC cable.
- Do not place the device near naked flames or other heat sources (heaters, direct sunlight, gas ovens etc.).
- Do not let the device operate unattended.
- Never pull the plug out of the socket by the cable.

Scope of delivery

Component	Quantity
Rooftop tent	1
Telescopic ladder	1
PVC cover	1
Tool bag	1
U shaped bracket	4
M8 x 50 bolt	8
M8 x 16 screw	4
M8 1mm washer	8
M8 unscrewed washer	12
M8 1.5mm washer	4
M8 wing nut	4
Aluminum section plate	12
M8 plastic wheel nut	8
Plastic end cap	4
Gale 12V electric pump	1
Air hose	1
Nozzle adapter	6
Storage bag pocket	2
Storage net	1
Extension hose (1.4 m)	1

Accessories

Available as accessory (not included in the scope of delivery):

Component	Ref. no.
TRT 140 AIR Awning Low	9120002119
TRT 140 AIR Awning Tall	9120002120
Hand pump	9120000439

Intended use

This rooftop tent is suitable for:

- Mounting on a suitable roof rack on the rooftop of a suitable vehicle
- Light to moderate weather
- Touring

This rooftop tent is **not** suitable for:

- Use by persons with reduced physical, sensory or mental capabilities
- Very strong winds or snowfall
- Seasonal pitch or commercial use

The ladder is intended for attaching to this rooftop tent. The ladder may only be used in conjunction with this rooftop tent and may **not** be used independently.

The ladder is **not** intended for professional use.

This product is only suitable for the intended purpose and application in accordance with these instructions.

This manual provides information that is necessary for proper installation and/or operation of the product. Poor installation and/or improper operating or maintenance will result in unsatisfactory performance and a possible failure.

The manufacturer accepts no liability for any injury or damage to the product resulting from:

- Incorrect assembly or connection, including excess voltage
- Incorrect maintenance or use of spare parts other than original spare parts provided by the manufacturer
- Alterations to the product without express permission from the manufacturer
- Use for purposes other than those described in this manual

Dometic reserves the right to change product appearance and product specifications.

Technical description

The rooftop tent is equipped with inflatable air poles which can be filled using a single valve.

The ladder attached to the rooftop tent can be fitted to the height of the vehicle.

The rooftop tent includes a high-density foam mattress.

For transport on the rooftop of a vehicle, the rooftop tent can be folded down and covered with the supplied tent cover.

The roof rack on which the rooftop tent is to be installed has to meet the following requirements:

- The roof rack has to be able to carry at least 165 lbs/75 kg to allow for driving with the rooftop tent installed.
- The width of the roof rack has to be at least 27 in/68 cm.
- The two rails of the roof rack have to be between 28 in/70 cm and 50 in/125 cm apart.

Using the rooftop tent



WARNING! Risk of injury

- Ensure that the rooftop tent is firmly attached to the roof rack before climbing the ladder.
- Ensure that each step of the ladder is locked before you climb the ladder.
- Always climb the ladder with caution.
- Close the rooftop tent's entrance door before you go to sleep to prevent falling out of the rooftop tent while sleeping.
- If two people use the rooftop tent ensure that they do not both sit in the back or front or on one side of the tent at the same time. The tent may fall down if the weight of two people is on one side of the tent (fig. 33, page 11).
- Before driving with the mounted rooftop tent always ensure that the cover is tied down correctly (fig. 44, page 13).



CAUTION! Risk of injury

Never open the zipper on the protective sleeve while an air pole is inflated. This will result in the air pole bursting.



NOTICE! Material damage

- Keep the side window of the rooftop tent open while setting up or folding down the rooftop tent.
- Do not open or close the zippers by force.



NOTE

Use the integrated storage facilities while using the tent, so that nothing falls down or is forgotten in the tent when it is folded down (fig. 31, page 10).

Before first use

Familiarize yourself with the product by carrying out a test set up before the product is used for the first time. Check if the scope of delivery is complete.

Weathering your product before first use

The product is manufactured with materials that require preparation before use to maximize its weatherproofing.

1. Fully set up the product outside when rain is expected or where you can hose the outside of the product to become thoroughly wet.

This process is known as weathering. The weathering process tightens the fabric, and allows the cotton in the sewing thread to swell and fill the holes made by the sewing needle during the manufacturing process.

2. Allow the product to dry thoroughly before packing away.

By following this process before first use, will ensure that the product weatherproofing will improve with subsequent soakings.

Mounting the rooftop tent



CAUTION! Risk of injury

- Only lift the rooftop tent onto your vehicle together with another person.
- Ensure that no other persons, especially children, are near the vehicle when you and your helper lift the rooftop tent onto the rooftop of the vehicle.



NOTE

The side of the rooftop tent where the ladder will be mounted is marked. Ensure to align the rooftop tent so that the driver's door of the vehicle is not blocked by the extended ladder (fig. 4, page 3).

- To mount the rooftop tent proceed as shown (fig. 2, page 3 – fig. 15, page 6).

Setting up the rooftop tent



CAUTION! Risk of injury and material damage

- Do not use any type of compressor designed to inflate car tires.
- Only inflate the air poles up to a maximum pressure of 9psi/0.62bar.
- Do not put your fingers in the rung area when setting up or adjusting the ladder.

- To set the rooftop tent up proceed as shown (fig. 16, page 6 – fig. 36, page 11).

Folding down the rooftop tent



CAUTION! Risk of crushing

Do not put your fingers in the rung area when pushing the ladder together.

**NOTE**

The blue sliders at the bottom step of the ladder unlock all segments at once so that the ladder can be pushed together (fig. 41, page 13).

- ▶ To fold the rooftop tent down proceed as shown (fig. 37, page 12 – fig. 44, page 13).

Using the gale 12V electric pump

The gale 12V electric pump is equipped with a pressure induction system and switches off automatically as soon as the preset pressure is achieved. The pressure induction system operates with an error margin of ± 0.5 psi.

**NOTICE! Risk of overheating**

- Ensure that the electric pump is sufficiently ventilated during operation.
- Do not operate the electric pump continuously for longer than 15 min as the motor may overheat. Allow the electric pump to cool down for 30 min after 15 min of continuous use.

**NOTE**

- If no buttons have been pressed for 30 s, the LCD display will go into standby mode. Press any button to reactivate.
- At first it will take time for the pressure reading on the LCD display to increase. This is normal, as a large amount of air is initially required to fill the air frame before a significant change in pressure is detected.

Using the ladder

**CAUTION! Risk of injury**

Ensure that the locking mechanisms for all extended segments are locked before use of the ladder.

**NOTICE! Damage hazard**



Ensure that the maximum total load of the ladder is not exceeded. The maximum total load is 130 kg/ 287 lbs.

Setting up the ladder

**CAUTION! Risk of injury**

Observe the recommended set-up angle of $65^\circ - 75^\circ$ (fig. 22, page 8).

The sliders of the locking mechanisms can be moved to two positions to lock or unlock the segments (fig. 21, page 8):

- ▶ Move the sliders on both sides of the ladder onto  to lock the segment (fig. 21 A, page 8).
- ▶ Move the sliders on both sides of the ladder onto  to unlock the segment (fig. 21 B, page 8).

Storing

Storing the rooftop tent and the ladder

**CAUTION! Risk of injury**

- The ladder can remain mounted on the rooftop tent for storing. Ensure the ladder is pushed together completely and the locking mechanisms for all segments of the ladder are locked.
- When disassembling the ladder from the rooftop tent for storage, ensure that the ladder is stored in a position where it will remain straight (e.g., placed on a flat surface).

**NOTICE! Damage hazard**

The slider and the end caps of the ladder feet are made of plastic. Store the ladder in a place where it is protected from UV radiation.

1. Dismount the rooftop tent from the roof rack.
2. If necessary, clean the rooftop tent and the ladder.
3. Ensure the rooftop tent and the ladder are completely dry before packing away.
4. Store in a well ventilated dry place.

Storing the gale 12 V electric pump

1. If necessary, clean the gale 12 V electric pump.
2. Insert the plug in the opening provided.
3. Ensure the supply cord and air hose are not trapped or kinked before packing away.
4. Store in a well ventilated dry place.

Cleaning and maintenance

**WARNING! Risk of injury**

Only clean and maintain the rooftop tent on the ground. Never climb onto the vehicle for cleaning the rooftop tent while the rooftop tent is mounted on the rooftop.

**NOTICE! Damage hazard**

- Do not use sharp or hard objects or cleaning agents for cleaning.
- Do not use alcohol based materials, chemicals, soap and detergents for cleaning.
- Remove bird droppings and tree resin as soon as possible to avoid permanent damage to the material.
- Do not attempt to put any object into the inflation port of the gale 12 V electric pump as these can damage the internal pump mechanism.
- Repair of the ladder shall only be carried out by a competent person.

**NOTE**

- Fully set up the rooftop tent and the ladder for cleaning.
- Choose a sunny day for cleaning to ensure material will dry thoroughly.

- ▶ If necessary, clean the rooftop tent and the ladder with clean water and a soft brush.
- ▶ Apply impregnation against water and UV radiation on the rooftop tent before each trip.
- ▶ Occasionally clean the gale pump with a damp cloth.

Inspecting the ladder

**CAUTION! Risk of injury**

Do not use the ladder if any of the inspections in the following list cannot be fully satisfied.

Carry out the following inspections after delivery and before each use:

- ▶ Check that the ladder or components of the ladder are not bent, dented, excessively worn, corroded or rotten.
- ▶ Check that fixings, sliders and end caps of the ladder feet are not missing or loose.
- ▶ Check that the sliders engage properly on the rungs.
- ▶ Check that the entire ladder is free from contaminants (e.g. mud or snow).

Troubleshooting



NOTE

- During first exposure to water there may be some moisture at the seams. Through this moisture the threads will swell and fill the holes that are created in the sewing process.
- A fully equipped spare parts kit should include:
 - Waterproofer
 - Repair tape and repair solution
 - Silicone spray for the zippers

Problem	Solution
Rooftop tent only inflates with difficulties	<ul style="list-style-type: none"> ▶ Check that the valve is fully screwed into the air pole. ▶ Check if the inflation tube is twisted at the valve. This may be indicated by noise. Untwist the inflation tube. ▶ Check that the electric pump is working.
Part of the rooftop tent does not deflate	<ul style="list-style-type: none"> ▶ Check that all isolation valves that connect the air poles are open.
Air poles are kinked	<ul style="list-style-type: none"> ▶ Add more air (9 psi/0.62 bar).
Air leak	<ul style="list-style-type: none"> ▶ Check that the valve is fully screwed into the air pole and the ring seal is in place. ▶ Check that the cap of the valve is done up tightly. ▶ Check for punctures, see chapter "Repairing a puncture in the air pole" on page 19
Water leak	<ul style="list-style-type: none"> ▶ Check for leaky seams, damaged tapings and moist areas. ▶ If you cannot find any leaks, see chapter "Condensation" on page 19. ▶ If you find any leaks, apply seam sealant.
Rip in the fabric	<ul style="list-style-type: none"> ▶ Use repair tape to seal the fabric. ▶ Have repairs carried out by an authorized specialist.

Condensation

All tents suffer from internal condensation if one or more of the following conditions apply:

- High air humidity
- A drop in temperature

Severe condensation can run down the inside of the roof and drip off ties, tapes and other internal fittings and can be mistaken for leaking.

- ▶ Increase ventilation by opening doors and/or windows.

Repairing a puncture in the air pole

If the air pole loses air, proceed as follows:

1. Unzip the outer sleeve holding the air pole.
 2. If installed, close isolation valves.
 3. Remove the air pole.
 4. Deflate the air pole.
 5. Unzip the protective sleeve to expose the inflatable tube.
 6. Blow some air into the inflatable tube.
 7. Submerge the tube in water.
 8. Locate the puncture.
 9. Use repair tape and repair solution to seal the hole.
 10. Zip the inflatable tube back into the protective sleeve.
 11. Zip the air pole back into the outer sleeve.
- ▶ Also observe the information given in fig. 45, page 14 – fig. 46, page 14.

Disposal



- ▶ Place the packaging material in the appropriate recycling waste bins wherever possible.
- ▶ Consult a local recycling center or specialist dealer for details about how to dispose of the product in accordance with the applicable disposal regulations.
- ▶ The product can be disposed free of charge.

Warranty

The statutory warranty period applies. If the product is defective, please contact your retailer or the manufacturer's branch in your country (see dometic.com/dealer).

For repair and warranty processing, please include the following documents when you send in the product:

- A copy of the receipt with purchasing date
- A reason for the claim or description of the fault

Note that self-repair or non-professional repair can have safety consequences and might void the warranty.

The warranty covers manufacturing defects, materials and parts. The warranty does not cover fading of the cover and wear and tear due to UV radiation, misuse, accidental damage, storm damage, or permanent, semi-permanent or commercial use. It does not cover any resulting damage. Please contact your dealer for claims. This does not affect your statutory rights.

Technical data

	TRT 140 AIR
Foam mattress depth	1.3 in/3.2 cm
Anti-condensation layer depth	0.2 in/0.5 cm
Usable interior space (W x H x D)	55 x 43 x 83 in 140 x 110 x 210 cm
Dimensions outer tent (W x H x D)	57 x 47 x 86 in 145 x 120 x 219 cm
Packing dimensions tent (W x H x D)	59 x 13 x 32 in 149 x 33 x 82 cm
Packing dimensions ladder and accessories (W x H x D)	31 x 5 x 20 in 79 x 12 x 49.5 cm
Weight (including ladder)	127.1 lbs/57.65 kg

	Gale 12 V Pump
Voltage	12 V===
Delivery rate	26 gal/100 l/min ± 10%
Operating time	maximum 15 min
Noise emission	32 dB
Dimensions (W x H x D)	11 x 3.5 x 7.9 in/ 280 x 90 x 200 mm
Weight	3.9 lb/1.79 kg