

GS PRO RA 25S4 1000X525

EASY TO MOVE



LIFTER GS PRO, SPECIAL AND 3000 KG

The GS PRO pallet truck is equipped as a standard with an entry and exit roller and a more ergonomic handle than the GS Basic. Available with weight capacity of up to 3000kg.



MAXIMUM PRESSURE VALVE

When the maximum load capacity is exceeded, oil pressure exceeds its maximum limit and the valve automatically locks the forks. Thus possible structural damage is avoided.



VARNISHING

Following an appropriate conditioning operation the frame is varnished with polyester powder at a temperature of 250° to guarantee maximum resistance to wear and atmospheric agents.

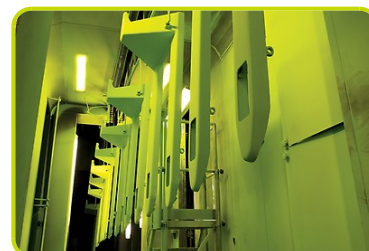

Description

1.1 Manufacturer			LIFTER
1.3 Drive			Manual
1.4 Operator type			Pedestrian
1.5 Load capacity	Q	Kg	2500
1.6 Load centre distance	c	mm	500
1.8 Load axle to end forks	x	mm	782
1.9 Wheel base	y	mm	1042

Weights

2.1 Service weight		Kg	60
2.2 Axle load, laden rear		Kg	1797
2.2 Axle load, laden front		Kg	763
2.3 Axle load, unladen front		Kg	38
2.3 Axle load, unladen rear		Kg	22

Tyres/Chassis

3.1 Tyres: front wheels			POLY.I./ NYLON
3.1 Tyres: rear wheels			NYLON
3.2 Tyre size: Steering wheels - Diameter		mm	200
3.2 Tyre size: Steering wheels - Width		mm	55
3.3 Tyre size: Load rollers - Diameter		mm	82
3.3 Tyre size: Load rollers - Width		mm	60
3.5 Tyre size: rear wheels - Q.ty (X=driven)		nr	4
3.5 Rear balancing axle			No
3.6 Tread, front	b10	mm	155
3.7 Tread, rear	b11	mm	375

Dimensions

4.4 Lift height	h3	mm	115
4.9 Height of tiller in drive position max	h14	mm	1160
4.15 Height, lowered	h13	mm	85
4.19 Overall length	l1	mm	1400
4.20 Length to face of forks	l2	mm	400
4.21 Overall width	b1	mm	525
4.22 Fork dimensions - Thickness	s	mm	55
4.22 Fork dimensions - Width	e	mm	150
4.22 Fork dimensions - Length	l	mm	1000
4.25 Distance between fork arms	b5	mm	525
4.32 Ground clearance, centre of wheelbase	m2	mm	30
4.34 Aisle width	Ast	mm	1635
4.35 Turning radius	Wa	mm	1217

Performance data

5.2 Lifting speed laden	strokes	13
5.2 Lifting speed unladen	strokes	13

*Available accessories: tandem rollers, polyurethane rollers (as a standard on Premium), rubber guide wheels, manual control brake

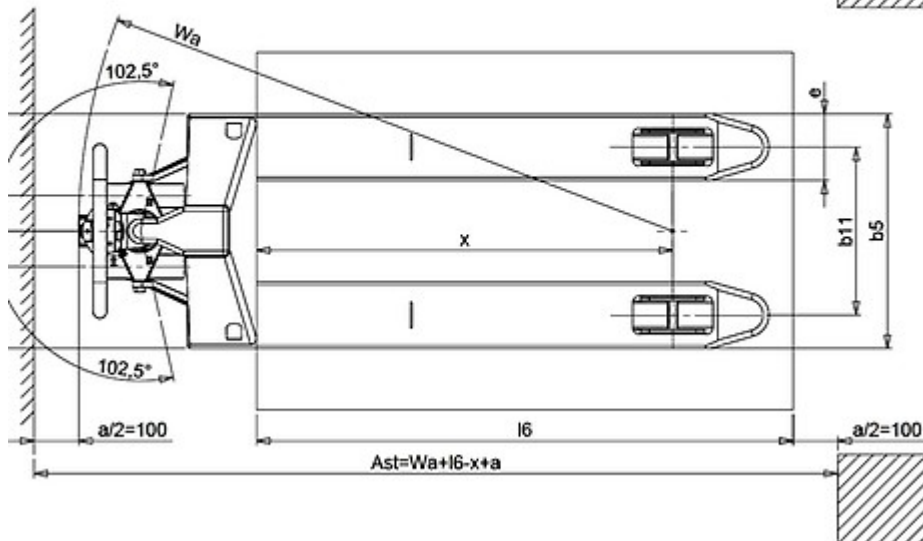
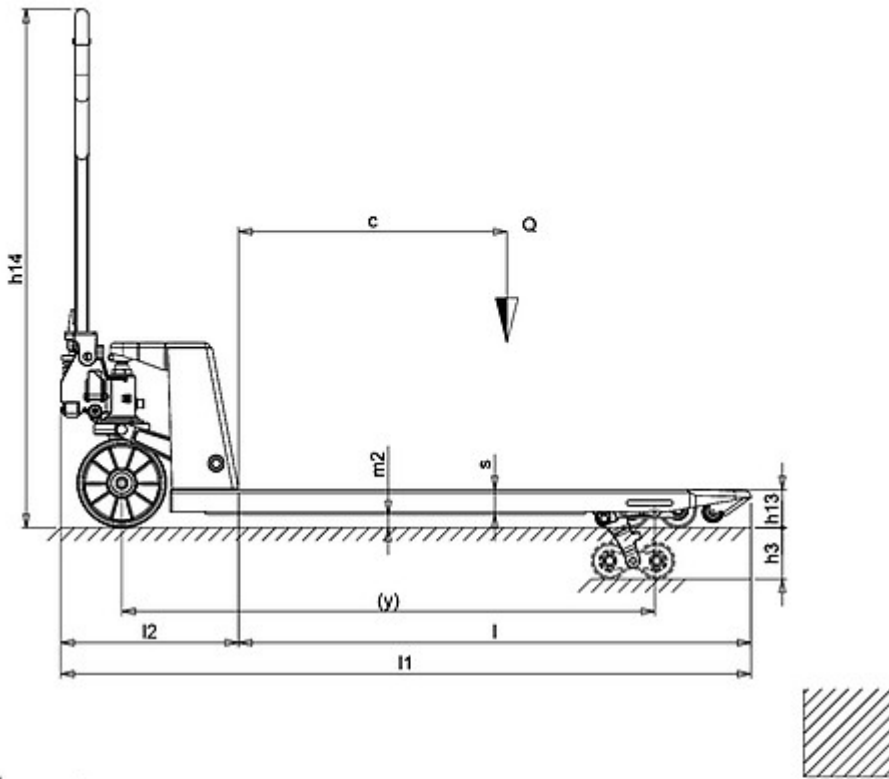

www.pramac.com

The information is aligned with the Data file at the time of download. Printed on 09/10/2017 (ID 562)

©2017 | PR INDUSTRIAL s.r.l. | All rights reserved | Image shown may not reflect actual package. Specifications subject to change without notice

