

HX10E 2000X540

LIFTING STABILITY



HX10

The HX10 series, which is available in both a manual and an electric version, allows for easy and light lifting to a height of 800 mm, thus becoming a practical work platform, which is suitable for places such as machine workshops. This pallet truck is also able to carry out the support function and material supply along the assembly and production lines.

CONTROL LEVER

The redesigned hydraulic unit allows for less effort at the steering wheel for all loads and a quick elevated function (30 cycles) for loads up to 150 kg.



EMERGENCY PUSHBUTTON

The emergency pushbutton with a battery cut-off (isolator) switch function and an off-load valve allows for a smoother lowering of the load; these are some of the devices that make the work safer and more efficient.



FRONT AND REAR STABILISERS

The new control linkage makes the entry onto the closed side of the pallet possible by slight lifting, which facilitates the successive handling phases. Furthermore, more machine stability has been obtained using load rollers in a more advanced position and by providing front stabilisers as a standard.

Rear stabilizers, in turn, render work stable and safe even in the case of elevated loads once the 400 mm of lifting up have been exceeded.



PHOTO AUTO LEVELING SYSTEM

- An automatic system which, by means of a photocell, adjusts the height of the forks, thus maintaining the work height set.
- An optical and acoustic signal is activated at every fork movement.
- Possibility of adjusting the photocell both in height and reading angle.
- Micro-switch, active both on the way up to prevent superfluous absorption of energy and on the way down to protect the operator.



Description

1.1 Manufacturer	LIFTER		
1.3 Drive	Manual		
1.4 Operator type	Pedestrian		
1.5 Load capacity	Q	Kg	1000
1.6 Load centre distance	c	mm	1000
1.8 Load axle to end forks	x	mm	1509
1.9 Wheel base	y	mm	1748

Weights

2.1 Service weight (battery included)	Kg	262
2.2 Axle load, laden rear	Kg	801
2.2 Axle load, laden front	Kg	461
2.3 Axle load, unladen front	Kg	169
2.3 Axle load, unladen rear	Kg	93

Tyres/Chassis

3.1 Tyres: front wheels	RUBBER	
3.1 Tyres: rear wheels	POLY.I.	
3.2 Tyre size: Steering wheels - Width	mm	50
3.2 Tyre size: Steering wheels - Diameter	mm	200
3.3 Tyre size: Load rollers - Diameter	mm	80
3.3 Tyre size: Load rollers - Width	mm	50
3.5 Tyre size: rear wheels - Q.ty (X=driven)	nr	2
3.6 Tread, front	b10 mm	155
3.7 Tread, rear	b11 mm	447

Dimensions

4.4 Lift height	h3	mm	715
4.9 Height of tiller in drive position max	h14	mm	1300
4.9 Height of tiller in drive position min	h14	mm	915
4.15 Height, lowered	h13	mm	85
4.19 Overall length	l1	mm	2543
4.20 Length to face of forks	l2	mm	540
4.21 Overall width	b1	mm	540
4.22 Fork dimensions - Thickness	s	mm	48
4.22 Fork dimensions - Width	e	mm	160
4.22 Fork dimensions - Length	l	mm	2000
4.25 Distance between fork arms	b5	mm	540
4.32 Ground clearance, centre of wheelbase	m2	mm	21
4.34 Aisle width	Ast	mm	2763
4.35 Turning radius	Wa	mm	2058

Performance data

5.2 Lifting speed laden	m/s	0.08
5.2 Lifting speed unladen	m/s	0.13
5.3 Lowering speed laden	m/s	0.13
5.3 Lowering speed unladen	m/s	0.06

Electric motors

6.2 Lift motor power	kW	1.6
typ baterii		Automotive (C20)
6.4 Battery voltage	V	12
6.4 Battery capacity, Min	Ah	60
6.4 Battery capacity, Max	Ah	60
6.5 Battery weight, Min	Kg	14
6.5 Battery weight, Max	Kg	14

*Battery and external battery charger
Also available in GEL version and with an integrated battery charger

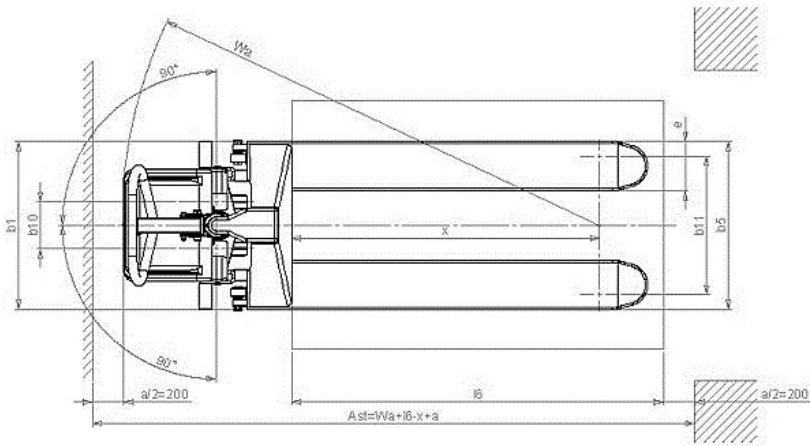
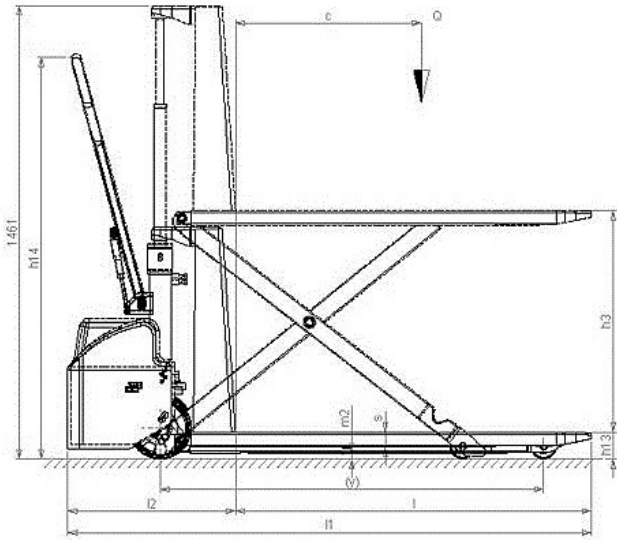

The information is aligned with the Data file at the time of download. Printed on 12/10/2017 (ID 485)

©2017 | PR INDUSTRIAL s.r.l. | All rights reserved | Image shown may not reflect actual package.
Specifications subject to change without notice

