

## Installation, use and maintenance manual

# **SMART 60**

## **Digital 12/24 V dc**



**Model.: SMART 60**

**Matriculation number: 60S12/24D**

**Year of construction: 2002**

**Schenker Italia**

Via Delle Repubbliche Marinare, 67

80147 Naples Italy

Tel. +39 081 5593505

Fax. +39 081 5597372

E-mail: info@schenker.it

***WWW.schenkerwatermakers.com***

## INDEX

1. MANUAL CONSULTING .....	4
1.1 STRUCTURE OF THE MANUAL .....	4
1.2 DESCRIPTION OF THE PICTOGRAMS .....	4
2. GENERAL WARNINGS AND INFORMATION TO THE RECIPIENT .....	5
2.1 IMPORTANT INFORMATION .....	5
2.2 SAFETY WARNINGS .....	5
2.3 START-UP .....	6
2.4 WARRANTY .....	6
2.5 IDENTIFICATION OF THE UNIT .....	7
2.6 NORMATIVE REQUIREMENTS .....	7
2.6.1 DIRECTIVES AND STANDARDS CONCERNING MACHINE SAFETY .....	7
2.6.2 RESPECT FOR THE ENVIRONMENT – REQUIREMENTS FOR DEMOLITION AND DISPOSAL .....	7
3. PRODUCT PRESENTATION .....	9
3.1 TRANSPORT AND MATERIAL HANDLING .....	9
3.2 STOCK .....	10
3.3 PACKAGING .....	10
3.3.1 PACKAGING CONTENTS .....	10
3.4 ATTACHED DOCUMENTS .....	11
3.5 TECHNICAL DATA .....	11
3.6 CHARACTERISTIC OF THE PRODUCT .....	12
3.7 ADVANTAGES OF THE ENERGY RECOVERY SYSTEM .....	13
3.8 COMPOSITION OF THE MACHINE .....	14
3.8.1 PUMP GROUP .....	14
3.8.2 WATERMAKER GROUP .....	15
3.8.3 ACCESSORIES .....	18
4. MOUNTING AND INSTALLATION .....	18
4.1 GENERAL CRITERIA .....	18
4.2 COMPONENTS MOUNTINGS .....	20
4.2.1 PUMP GROUP .....	20
4.2.2 WATERMAKER GROUP .....	20
4.2.3 ACCESSORIES .....	20
4.3 INSTALLATION .....	20
4.3.1 WATER INTAKES AND DISCHARGES .....	20
4.3.2 SEAWATER INTAKE .....	21
4.3.3 FRESH WATER INTAKE FOR WASHING .....	22
4.3.4 BRINE DISCHARGE .....	22
4.4 HYDRAULIC CONNECTIONS .....	23
4.5 ELECTRIC CONNECTION .....	26
4.5.1 REMOTE CONTROL PANEL MOUNTING .....	26
4.5.2 ELECTRIC CONNECTIONS: WIRES (SMART 60 12/24V DC) .....	27
4.2.1 ELECTRIC LAYOUT SCHEME (12/24V DC) .....	29
5. FUNCTIONING AND USE .....	30
5.1 COMMAND DESCRIPTION .....	30
5.2 INTRODUCTION – BY PASS MODE .....	35
5.3 FIRST START UP PROCEDURE .....	35
5.3.1 PRELIMINARY CHECKS BEFORE PROCEEDING WITH THE STARTUP PROCEDURE .....	35

5.3.2 START UP .....	36
5.4 NORMAL OPERATING PROCEDURE .....	37
5.4.1 NORMAL OPERATING PROCEDURE WITHOUT TIMER.....	37
5.4.2 NORMAL OPERATING PROCEDURE WITH TIMER .....	37
5.4.3 SINGLE WASHING OPERATION.....	38
5.4.4 PERIODIC WASHING.....	38
5.4.5 AUTOMATIC FUNCTIONING WITH LEVEL CONTROLS (OPTIONAL) .....	38
5.5 RESET PROCEDURE .....	40
<b>6. MAINTENANCE (ROUTINE AND EXTRAORDINARY).....</b>	<b>42</b>
6.1 CONTROL OF FILTER CLEANING CONDITION .....	42
6.2 CHECK THE PLANT WORKING PRESSURE .....	43
6.3 CHECK FOR ABSENCE OF LEAKS .....	43
6.4 CHECK FOR MEMBRANES REPLACEMENT .....	43
6.5 SHUTDOWN PROCEDURE .....	43
6.5.1 NECESSARY EQUIPMENT .....	44
6.5.2 SHUTDOWN OPERATING PROCEDURE.....	46
6.6 ANTIFREEZE PROCEDURE (WINTERIZING PROCEDURE IN COLD CLIMATE - UNDER 5°C).....	49
6.7 PERIODIC MAINTENANCE.....	50
6.7.1 MEMBRANE REPLACEMENT.....	50
6.8 ADJUSTMENTS .....	50
<b>7. TROUBLESHOOTING.....</b>	<b>51</b>
7.1 FAILURE CHART .....	51
7.2 ELECTRONIC ISSUES AND THEIR SOLUTION.....	52
<b>8. SUGGESTED SPARE PARTS.....</b>	<b>53</b>
8.1 SHORT TERM CRUISING.....	53
8.2 LONG TERM CRUISING .....	53
8.3 ERS SPARE PARTS .....	54
8.4 ADDITIONAL SPARES .....	55

## 1. MANUAL CONSULTING

### 1.1 Structure of the manual

The manual is divided into chapters, which gather all the information necessary to use the system without any risk.

Within each chapter there is a subdivision in paragraphs to focus on essential points; each paragraph can be pointed out with a subtitle and a description.

At the top of each page the heading section is reported in order to remind the reader the field of the page.

Within the chapter, for example chapter 1, we will have:

1	Chapter title
1.1	Paragraph title
1.1.1	Subtitle
1.1.1.1	Further subtitles

The numbering of the pages, figures and tables, is reset to each chapter; therefore, we will find the prefix indicating the chapter and the page number, figure or table in progressive that starts from number 1 at the beginning of each chapter.

### 1.2 Description of the pictograms

The following symbols will be used in the manual to highlight particularly important indications and warnings:



**ATTENTION:**

This symbol indicates accident prevention regulations for the operator and / or for any exposed persons.



**CAUTION:**

This symbol indicates that there is the possibility of damaging the system and / or its components.



**NOTE:**

This symbol indicates useful information.

## 2. GENERAL WARNINGS AND INFORMATION TO THE RECIPIENT

### 2.1 Important information

To safeguard the operator's safety and to avoid possible damage to the machine, before carrying out any operation on the machine, it is essential to read carefully all the instructions manual.

This manual must be complete and legible in its entirety, every operator involved in the use of the machine, or responsible for maintenance or adjustment operations, must know its location and must have the possibility to consult it at any time.

All rights of reproduction of this manual are reserved to SCHENKER ITALIA. This manual cannot be transferred to third parties without the written authorization of SCHENKER ITALIA.

The text cannot be used in other printed matter without the written permission of SCHENKER ITALIA.

The descriptions and illustrations provided in this publication are not binding.

SCHENKER ITALIA reserves the right to make any modifications it deems appropriate.

© SCHENKER ITALIA

THIS MANUAL IS PROPERTY OF SCHENKER ITALIA, ANY REPRODUCTION, EVEN PARTIAL, IS PROHIBITED.

This manual was drafted according to the requirements of the 2006/42 / EC Machinery Directive.

### 2.2 Safety warnings

- Wear protective equipment suitable for service operation.
- Clothing must be tight to the body, and resistant to the products used for cleaning.
- Do not remove safety devices or accident prevention protections.
- Check if the plant is correctly installed eventually contacting a Schenker service point.
- Verify that the electric and hydraulic connections are in keeping with the indicated specifications.
- The water produced by a Schenker plant, starting from picking clean seawater, is potentially potable, but the drinkable cannot be guaranteed because a bacterium may be present in some points of the plant, especially in case of non-observance of shutdown and cleaning procedures. So, avoid drinking the water produced by the plant if a sterilizer system has not been installed.
- Avoid using the plant if the sea water is polluted.
- Children and inexperienced people shall not touch or operate the plant.
- Check periodically that no leakage is present. Avoid installing the plant where an eventual leakage may cause damages and jeopardize the safety.
- Unqualified and non-Schenker personnel shall not perform any maintenance work.



## **ATTENTION**

***Any technical changes or operating conditions indicated that affect the correct operation or safety of the machine must only be carried out by the manufacturer's technical staff or by technicians formally authorized by the manufacturer. Otherwise, SCHENKER ITALIA declines any responsibility for changes or damages that may result from it.***

### **2.3 Start-Up**

The system SMART60 test and validation takes place at the end of the assembly at Schenker Italia production site.

### **2.4 Warranty**

The equipment and the relevant accessories are guaranteed 12 months from delivery. The guarantee does not include consumable items (filters, carbon filters, membranes, etc.). The "ERS" pressure amplification device is guaranteed 36 months, provided that the annual maintenance is performed at a Schenker service point.

The guarantee covers faults, defect of materials and parts. It is limited to the replacement or repair of faulty parts. The expense for the disconnecting and reinstalling on the vessel and transport of the equipment from or to our Service Point, or our factory will be at the customer's own expense.

The under guarantee delivered parts transport, will be at customer's own risk.

In case of repairs under guarantee performed by our technicians on the customer vessel, the faulty parts replacement cost will be at Schenker's expense, while manpower and travel expenses will be charged to the customer. The guarantee does not include faults caused by negligence in operating, maintenance and installation of the device (if not carried out by an authorized Schenker Service point).

Dismantling by non-authorized personnel will render void all guarantees. Schenker Italia cannot be held liable for any direct or indirect damage caused by the malfunctioning equipment, limiting its responsibility to the repair and replacement of faulty parts.



## **ATTENTION**

***SCHENKER ITALIA declines any responsibility for improper use of the machine, for damages caused as a result of operations not covered by this manual or unreasonable use.***

## 2.5 Identification of the unit

All the watermakers manufactured by Schenker Italia can be identified through a serial number printed on a label which is pasted upon the aluminum frame near the manometer. The same serial number is also recorded on the central black block of the energy recovery system (ERS).

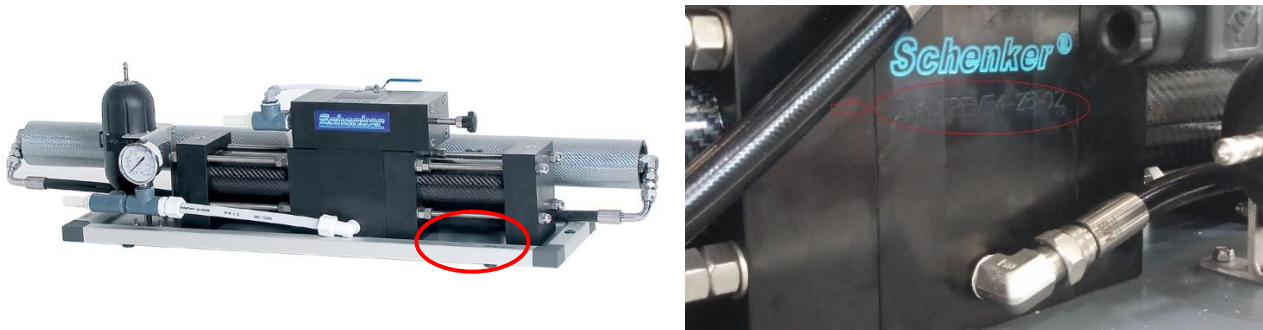

Serial number  
Fig. 2-1

## 2.6 Normative requirements

### 2.6.1 Directives and standards concerning machine safety

- Machinery Directive 2006/42 / EC, in force since December 29, 2009;
- Low Voltage Directive 73/23 / EEC and subsequent amendments and additions: 93/68 / CEE implemented by the Law of 18 October 1997 n. 791.
- Electromagnetic Compatibility Directive 89/336 / EEC and subsequent amendments and additions: 93/31 / CEE implemented with D.L. December 4, 1992 n. 476.
- Standards UNI EN 292/1 and 292/2 (safety of machinery);

### 2.6.2 Respect for the environment – requirements for demolition and disposal



#### **ATTENTION**

***Evacuate and dispose of materials, as result of the demolition of the machine, must be performed in accordance with the regulations in force, for the safeguard and protection of the environment.***

With regard to demolition and disposal, it should be noted that the materials of which the machine is made of are not of a dangerous nature and consist essentially of:

- Stainless Steel;
- Aluminium;
- Plastic;
- Carbon fibre;
- Motors, cables and consumable electrical materials;
- Rubber and polyurethane seals;

After dismantling the machine, the various materials must be segregated according to the regulations of the country in which the machine has been removed.

The machine does not contain dangerous components or substances that require special removal procedures.



**ATTENTION**

*Different legislations are in force in the different countries, therefore the prescriptions imposed by the laws and by the agencies designated by the Countries must be observed.*



## 3. PRODUCT PRESENTATION



### ATTENTION

**Be sure to follow general safety instructions.**

- Wear protective equipment suitable for the transport and handling operations.
- Lift the machines with equipment appropriate to the weight and size of the box, taking the utmost care and following carefully the instructions on the present use and maintenance manual (attachment points for loading devices, etc.).
- Make sure that the lifting equipment used is in good condition and correctly maintained.
- Do not stand or pass under the groups to be moved during lifting or transport operation.

### 3.1 Transport and material handling

The watermaker unit is transported in a carton box. In the following table dimension and weight are indicated.

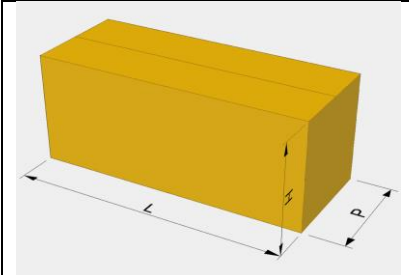

**MATERIALS HANDLING**  
fig. 3-1

	Model	L cm.	W cm.	H cm.	Weight Kg.
	Manual	146	46	48	45
	Electron	146	46	48	45

**Packaging dimensions and weight**  
tab.3-1

### 3.2 Stock



#### ATTENTION

To avoid undesirable damages to the system be aware to stock the unit in a dry place with temperature between 5 and 40 °C. Coldest temperature could led to a freeze of the fluid inside the system with the consequence of a permanent fault of the system.

### 3.3 Packaging

#### 3.3.1 Packaging contents

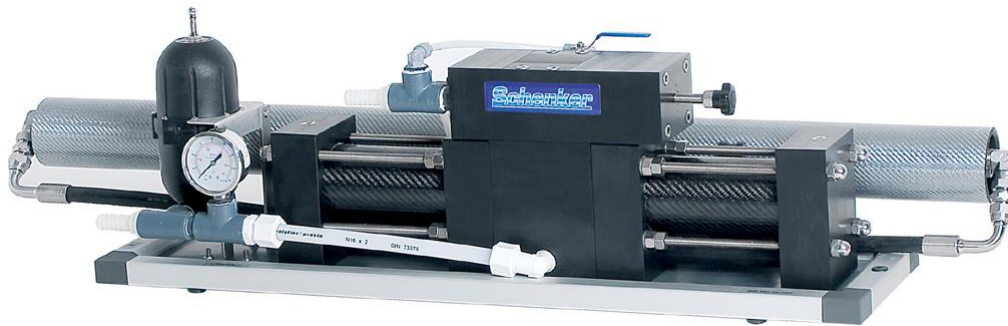

PACKAGING  
FIG. 3-2

SMART 60	
Watermaker	Pump group
Active carbon filter with electrovalve	White filter key
Net filter	Non-return valve with Tee fitting
Remote panel with electric box	10 mt extension cable for remote panel
Intallation kit	Small metal goods
6x8 hose for production	Pipe fittings

### 3.4 Attached documents

The packaging contains the technical documentation (use and maintenance manual, electric and hydraulic scheme, warnings and instructions).



#### ATTENTION

- **Lift the system only** using the aluminium structure and not through the Inox SS fittings.
- Read carefully the use and maintenance manual before installing the system.
- Use only recommended material for the installation (especially pipes, fittings and seals) in accordance with the present manual.
- Do not stock the unit under temperature of 5°.



DOCUMENTS INCLUDED IN THE PACKAGING  
FIG. 3-3

### 3.5 Technical data



#### NOTE:

*The following technical data refers to the watermaker SMART 60 12/24V Digital version*

#### WATERMAKER GROUP

##### Dimensions

Length:	118 cm
Width:	24 cm
Height:	24 cm
Weight:	21 Kg

##### Hydraulic Connection

Seawater inlet:	3/4" fitting, 16mm internal diameter reinforced hose.
Exhaust:	1/2" fitting, 16mm internal diameter reinforced hose.
Fresh water:	1/4" fitting, 6x8mm hose.

#### PUMP GROUP

##### Dimensions

Length:	34 cm
Width:	19 cm
Height:	35 cm
Weight:	10 Kg

**Hydraulic Connection**

**Water inlet:** 3/4" fitting, 16mm internal diameter reinforced hose.  
**Water outlet:** 3/4" fitting, 16mm internal diameter reinforced hose.

**Feed pump type:** Shurflo diaphragm pump

**Filters:** n. 1 Cartridge filter 5 microns 2.32" x 9 3/4"  
n. 1 Active carbon filter 2.32" x 9 3/4"

**Power supply:** 12 VDC +/- 15% (60S12 version)  
24 VDC +/- 15% (60S24 version)

**Average electric consumption:** 250/h Watt average

**Peak electric consumption:** 400 Watt

**Nominal fresh water production:** 60 Lit/h +/- 20% @ seawater 25 °C salinity 35.000 ppm

**Fresh water quality:** Under 500 ppm TDS average

**CEE conformity:** In compliance with directives 89/392 CEE sect.1 (general safety machines requirements), 89/336 CEE (electromagnetic compatibility), 73/23 CEE (electric safety requirements)

### 3.6 Characteristic of the product

The machine uses sea water to produce fresh water.

The water produced by the Schenker plant, starting from clean sea water, is potentially drinkable. The requisite of potable water cannot be guaranteed, however, because in some parts of the system there may be a bacterial charge, especially in the event of non-observance of the cleaning and storage procedures. Therefore, it is suggested to avoid drinking the fresh water produced by the plant, if a UV sterilizer is not installed.

**ATTENTION**

***Do not drink fresh water produced by the watermaker if a UV sterilizer system is not installed.***

### 3.7 Advantages of the Energy recovery system

#### Introduction

Thank you for choosing a Schenker Watermaker.

As all the equipment, the knowledge of operating and maintenance procedures allows to use the system in the best way, and to guarantee a perfect functioning throughout the years. We invite you to read carefully this manual and to keep it for a quick reference.

#### Functioning principles

The Schenker watermakers, as alternative to the high-pressure pumps of traditional systems, utilizes the ENERGY RECOVERY SYSTEM patented device, which amplifies the pressure of common low-pressure pumps, and recoup all the hydraulic energy back from the membranes, allowing an high energy efficiency. The lack of high-pressure pumps makes the system silent and vibrations free, and enormously simplify the use because no adjustment is necessary for its operating.

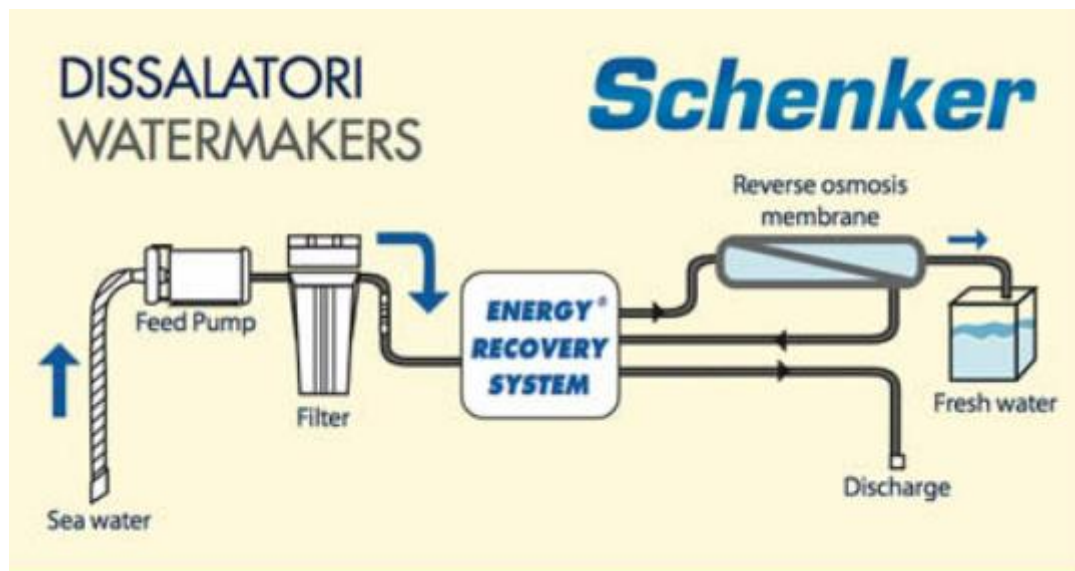

FUNCTIONING SCHEME  
FIG. 3-4

## 3.8 Composition of the machine

The machine is composed by the following parts:

### 1. PUMP GROUP

### 2. WATERMAKER GROUP

#### 3.8.1 Pump group

This pump has the duty of picking the sea water up and send it to the watermaker group, through the pre filter. The pump group is composed by the following components:

- 5 micron cartridge filter
- Diaphragm pump
- High pressure switch
- Pump box
- Pulsation dampener

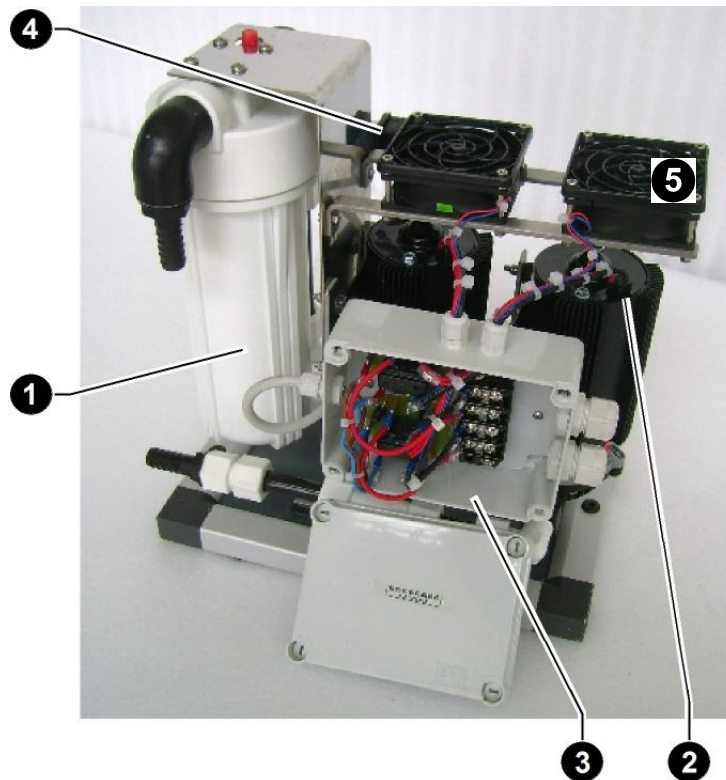

PUMP GROUP AND FILTER 12-24 V DC  
FIG. 3-5

- ① 5 micron cartridge filter
- ② Diaphragm pump

- ③ Pump box with relays
- ④ High pressure switch

## 3.8.2 Watermaker group



WATERMAKER GROUP  
FIG. 3-6

- |   |                           |   |   |
|---|---------------------------|---|---|
| 1 | Manometer                 | 4 | Fresh water production (grey plastic fitting) |
| 2 | Pulsation dampener        | 5 | Positioner knob                               |
| 3 | Reverse osmosis membranes |   |   |



WATERMAKER GROUP (TOP VALVE VIEW)  
FIG. 3-7

- |   |                        |   |                             |
|---|------------------------|---|-----------------------------|
| 1 | Reset valve            | 3 | Concentrate water discharge |
| 2 | Depressurization valve | 4 | Signal pressure switch      |

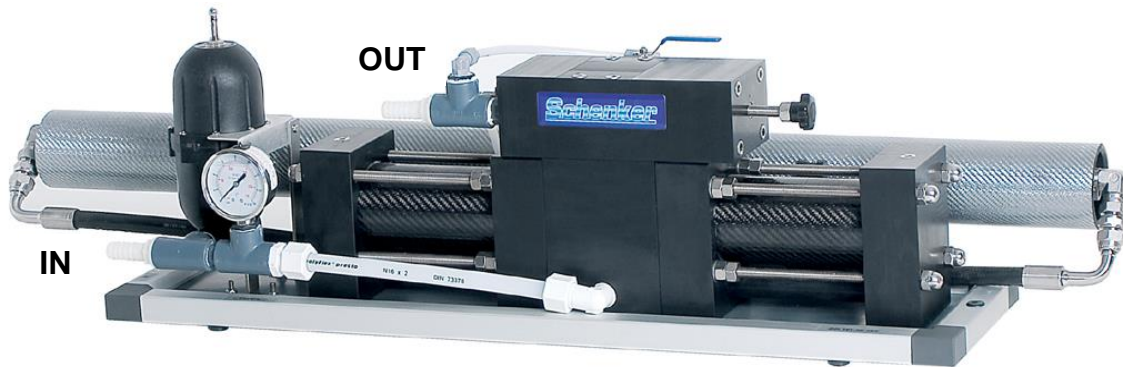

CONCENTRATE OUTLET (OUT) AND SEAWATER INLET (IN)  
FIG. 3-8

The watermaker group is composed by the following components:

- Reverse osmosis membranes
- Energy Recovery System
- Manometer
- Flowmeter
- Depressurization valve
- Positioner
- Reset valve
- Probe (pressure switch)
- Electric box.

**Reverse osmosis membranes**, are installed inside the glass fibre high-pressure housing. Membranes are n.1 x SW2540 type. Their purpose is to separate the intake high-pressure seawater in two flows: one for the salt-water drain and one for the fresh water production.

**Energy Recovery System** It is the black, carbon fibre unit. It has the function to amplify the pressure supplied by the pumps and to recoup the hydraulic energy back from the membranes. The ERS device makes periodic cycling by a hydraulically controlled automatic valve. The cycles are noticeable through a "beat" issued periodically by the watermaker unit. The unit is based on cylinders and a central body containing the hydraulic valve necessary for the system functioning.

**Manometers.** It is located on the front panel of the watermaker, and it measures the working pressure of the watermaker.

**Pulsation dampener** is a black plastic cylinder, installed in the watermaker. Its function is to reduce and stabilize the pressure peaks during the watermaker functioning. The device has to be pre-charged with air through the specific valve. The air pressure precharge is about 4 Bar. The pressure dimmer is charged in factory at the right pressure.

**Depressurization valve.** It is used for the air bleeding of the unit. It is recognizable by a blue lever and it is located on the top of the ERS. Its function is to depressurize the system and to allow the bleeding of air. The valve must be closed during normal working conditions (vertical position), and it is opened during the air bleeding operations (horizontal position).

**Positioner.** It is a stainless steel threaded arm, with a black knob, located on the right side of the watermaker. Its function is to reset the unit in case of hydraulic block.



**Reset valve.** It is installed on the watermaker on the top side of the ERS and it is recognizable by the little blue plastic lever. The valve must be closed during normal functioning (lever perpendicular to the valve). Such valve has the function to allow the reset of the ERS in case of a system block. It must be opened before acting on the valve positioner.

**High pressure switch.** It is hydraulically connected with the pump group. It stops the system if the pump pressure exceeds 9,5 bar. In this case a high-pressure alarm is activated on the control panel.

**Probe (Signal pressure switch).** It is a device, hydraulically connected to the left side on the main valve of the Energy Recovery System. Its function is check that the cycling of the machine is correct. It is set at 1,3 bar.

**Computer box.** It is an external unit. It has to be installed relatively close to the watermaker, in a position protected from water. It is connected to the remote panel and controls the functions of the watermaker automatically.

The microswitches P1 and EV allow the direct command of the pump the electrovalve respectively. They can be used, as an emergency solution, for starting the watermaker in case of total failure of the electronic computer. In normal condition they have to be switched off.

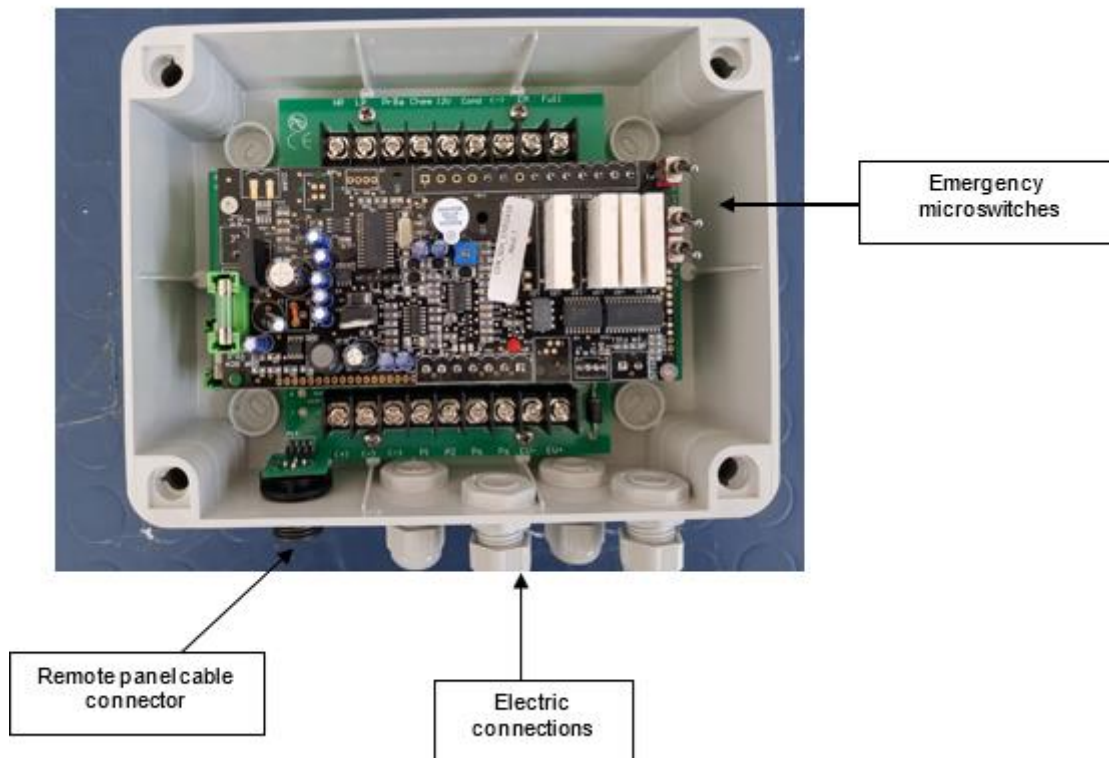

COMPUTER BOX WITH SWITCHES  
FIG. 3-9

### 3.8.3 Accessories

The main accessories of the watermaker are the followings:

- Active carbon filter
- Electrovalve
- Non-return valve
- Net filter (strainer)

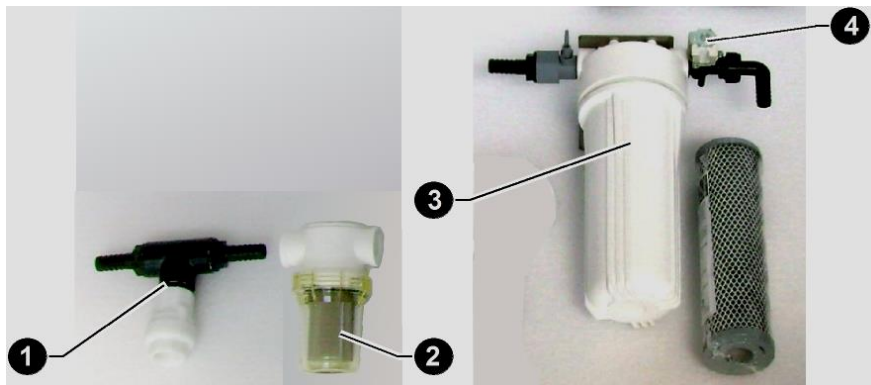

ACCESSORIES  
FIG. 3-9

- ① Non-return valve
- ② Net filter (strainer)

- ③ Active carbon filter
- ④ Elettrovalve

**Active carbon filter.** This filter is connected between the fresh water pressurized system of the boat and the electro valve on the filter holder. On the filter inlet is positioned a manual valve that allows to replace the cartridge without depressurize the fresh water system of the boat.

**Electrovalve.** It has the function of switching from seawater intake to fresh water tank when washing the watermaker.

**Non-return valve.** It avoids the emptying of the inlet pipes. It must be installed horizontally. It avoids also the leak of fresh water from the seacock while washing procedure.

**Net filter:** The machine is equipped with a strainer to protect the pump from macro sediments. It is placed between the seacock and pre-pump.

## 4. MOUNTING AND INSTALLATION

### 4.1 General criteria

Before starting with the installation, it is important to carefully plan all the activities, by evaluating all the possible solution to be adopted. The main points to focus on are the following:

- Individuate the seawater inlet
- Positioning of the main units (pump group, watermaker group, active carbon filter).
- Positioning of the magnetothermic switch.
- Passage of the pipes and electric cables.



**CAUTION**

*For a correct installation of the watermaker, in order to avoid issues along the different ways of operating condition, please follow carefully the general instruction below:*

- *Consider to install the through-hull fitting in a central and deep position, in the way that no air could be aspirated.*
- *The non-return valve has to be installed under the seawater level and as close as possible to the through-hull fitting, in vertical position.*
- *The pump must be installed as low as possible respect to the seawater level and as close as possible to the seawater intake (through-hull fitting).*
- *The watermaker unit must be horizontally positioned, and arranged on an adequate support which is able to sustain the weight (about 50 Kg).*
- *Provide to leave a space of about 20cm on the left side of the watermaker unit in order to allow the passage of inlet and outlet (discharge) pipes.*



**CAUTION**

*The pump group must be installed in a ventilated place, in order to facilitate the cooling. In addition to this, a place not exposed to condensation and dripping should be adopted.*



**ATTENTION**

*The external surface of motor and pump can reach high temperature; therefore, it is recommended to avoid any contact with inflammable liquids and materials.*



**NOTE**

*Once individuate the correct installation solution, it is recommended to first make a schematic draft of the hydraulic and electric connection, and attach them to the present manual for future needs as first reference.*

## 4.2 Components mountings

### 4.2.1 Pump group

The diaphragm pumps are a self-priming type, so the pump group may be installed relatively above the seawater level. Anyway, it is suggested to install the pump group as low as possible respect to the seawater level and as close as possible to the water inlet; furthermore, the pump cannot run dry. Therefore, it is very important avoiding to start the system if the intake valve is closed or if inlet filters are clogged.

The pump group should be installed in an adequately ventilated room, with the purpose to facilitate the cooling of the motor, and not subject to condensates or drippings. **The max permitted room temperature must not exceed 45°C.**

Avoid the contact or the proximity with inflammable material or liquid, since the motor surfaces can reach elevated temperatures. Avoid locating the pump wherever a possible loss of water can involve damages or jeopardize its safety. The pump must be installed on a base sufficiently horizontal, suitable to sustain the weight of the group. The pump is normally fixed on the support structure by passing bolts.

### 4.2.2 Watermaker group

Concerning the watermaker unit installation there are not height limits respect to the seawater level. Anyway, it should be installed above both pumps.

Avoid to install the system wherever any possible leak may cause damages to the boat or jeopardize its safety, since possible leaks due to accidental causes (pipe bursting, hose clamp loosening, equipment failure, etc.) may cause water losses.

The hydraulic intake and outlet connections are positioned on the left of the unit. Therefore, it is necessary to foresee a minimum distance of 20 cm. to allow the pipes laying. The watermaker unit must be installed on a base sufficiently horizontal, suitable to sustain the weight of the group. **The max allowed room temperature must not exceed 40°C.** It is advisable to install the unit in such position to make the instrumentation easily visible, and make the valves (located on the right of the unit) easily accessible. The watermaker is normally fixed on the support structure by passing bolts.

### 4.2.3 Accessories

The non-return valve has to be installed vertically as close as possible to the seawater intake, following the direction of the arrow.

The active carbon filter (and the attached electrovalve) has to be placed next to the pump group, if possible, on a vertical side easily accessible.



## 4.3 Installation

### 4.3.1 Water intakes and discharges

For a correct installation of the watermaker it is necessary to arrange the following water intake and discharge out of the board:

- Seawater intake.
- Fresh water intake for washing.
- Brine discharge.

### 4.3.2 Seawater intake

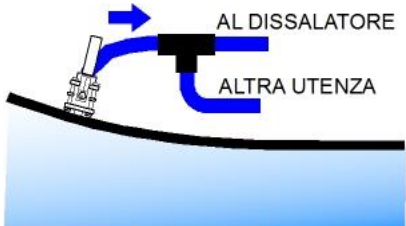
<p><b>Seacock with through-hull fitting</b></p>	<p>It is ideal a specific sea water intake, size 3/4" minimum in a central position, well under the water surface even when the vessel is well heeled over. The skin fitting is recommended. It must be oriented to the bow of the boat. In case of high speed vessel (over 15 knot) it is advised to make some holes on the backside of the shape, in order to reduce dynamic prevalence during navigation.</p>	<p>Size 3/4"</p> 
<p><b>Pre-existing seacock adapting (alternatively)</b></p>	<p>As alternative, it is possible Tee into a pre-existent water inlet as long as the following conditions are met:</p> <ul style="list-style-type: none"> <li>• 3/4" minimum size;</li> <li>• <b>No air can be introduced into the system from other use ie: salt water taps in galley;</b></li> <li>• Must always be under the water surface even when the vessel is well heeled over.</li> <li>• Must be far from WC discharge.</li> </ul> <p> <b>CAUTION</b> <i>Do not use the pre-existing water inlet of the cooling system dedicated to the motor.</i></p>	<p>Size 3/4"</p> 



#### INSTALLATION NOTES

- Allow a minimum 3/4" on-off ball valve on the water intake.
- The hose connections, especially if under the seawater level, must be secured with double hose clamps.
- An easily inspected mesh type filter will be required close to the water intake. The filter has to be of 50 microns. It is possible to use filters from existing outlets.
- The seawater intake must be at least 3/4" size.
- Downstream the seawater intake must be installed a strainer filter (not included) and a non-return valve. The water flow inhaled by the watermaker is about 6 lit/min.
- The strainer has to be dimensioned for a water flow of about 6 lit/min.

Net Filter		
<p><b>Strainer on existing hull (alternatively)</b></p>	<p>In case of seawater intake with pre-existing net filter, it is possible to use it as long as the following conditions are met:</p> <ul style="list-style-type: none"> <li>• Flow rate capacity of the filter is adequate to the whole intakes it serves.</li> </ul>	<p>Filtration grade of the strainer is <b>50 mesh.</b></p>



#### INSTALLATION NOTES

*The filter has to be connected next to the through-hull fittings, and must be easily accessible for inspection.*

### 4.3.3 Fresh water intake for washing

<b>Fresh water intake for washing</b>	Tee in downstream of the vessel's fresh water pressure system. The following conditions must be respected: <ul style="list-style-type: none"> <li>• The flow of the existing fresh water pump must be <b>min 10 lit/min.</b></li> <li>• Flushing must always be performed with the pressure water system ON.</li> </ul>	<b>Pressurized tank: Min. flow rate must be 10 lit/min. at 2,5 bar.</b>
---------------------------------------	--	---



**CAUTION**

**Pressurized tank: Min. flow rate must be 10 lit/min. at 2,5 bar.**

### 4.3.4 Brine discharge

<b>Salt water discharge</b>	The salt-water drain shall be ½" minimum size and it has to be preferably above the seawater level.	<b>Minimum size ½"</b>
<b>Pre-existing salt water discharge (alternatively)</b>	It is possible to use offtakes from existing apparatuses, provided that: <ul style="list-style-type: none"> <li>• It is not the engine cooling water drain or apparatuses that drain out water with elevated pressure.</li> </ul>	



**INSTALLATION NOTES**

**If the discharge is upon the seawater level, it is recommended to provide a valve along the pipe.**



**CAUTION**

**Do not run the system when the discharge valve is closed.**

## 4.4 Hydraulic connections

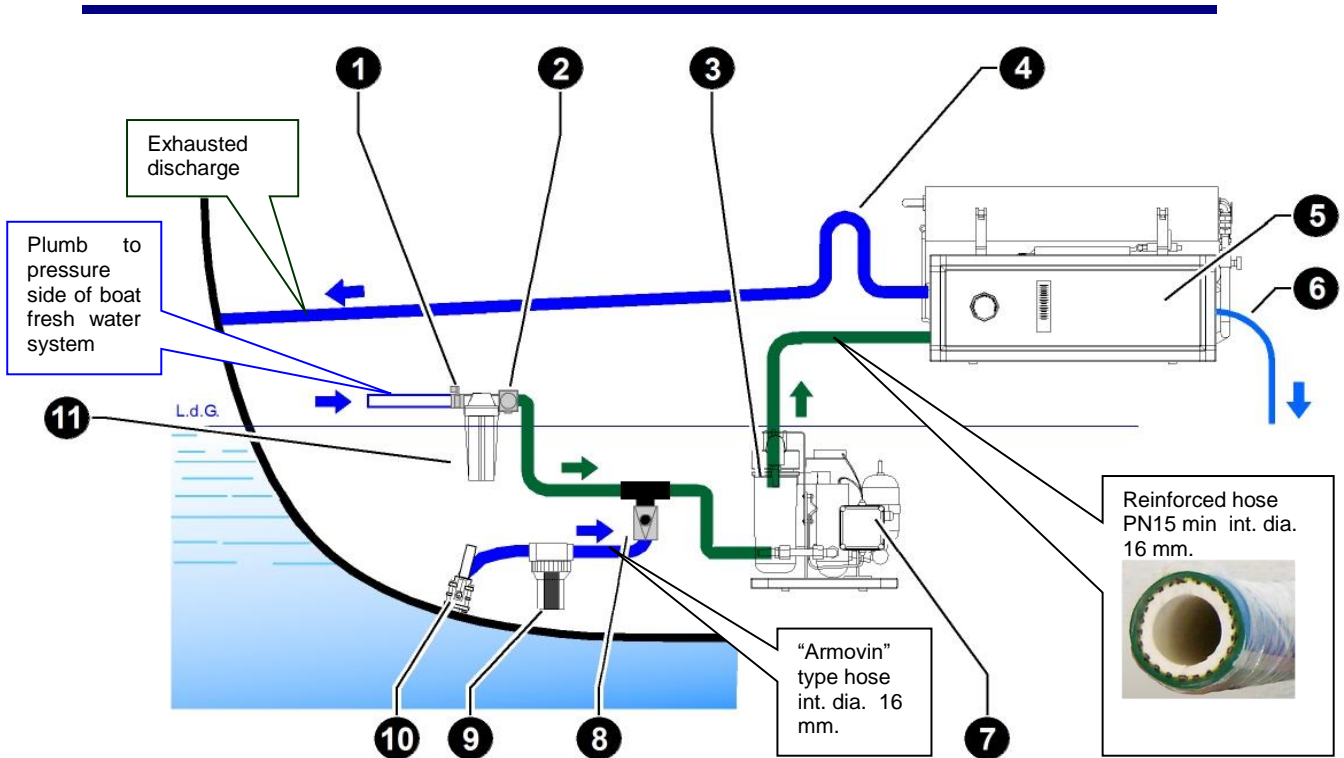

HYDRAULIC CONNECTION AND PIPES

FIG. 4-1

- |                                 |                        |
|---------------------------------|------------------------|
| ① Pressurized fresh water valve | ⑦ Pump                 |
| ② Electrovalve                  | ⑧ Non return valve     |
| ③ 5 micron filter               | ⑨ Net filter           |
| ④ Swan neck upward - Discharge  | ⑩ Water inlet          |
| ⑤ Watermaker                    | ⑪ Active carbon filter |
| ⑥ Fresh water outlet            |                        |

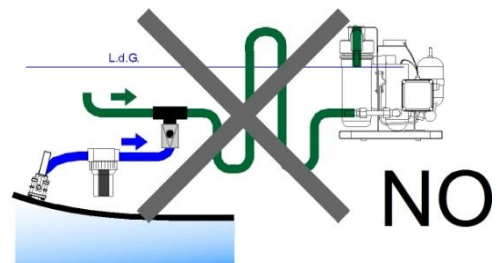
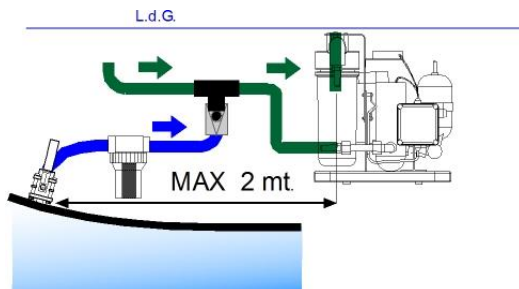

All the hydraulic connections (to exception of the fresh water production) have to be realized with a 16 mm. int. diam. hose and a 1/2" holder. The hydraulic section that is continuously under consistent pressure is the pump outlet – 5 m. filter – watermaker inlet connections. For this section is necessary to use a good quality **PN 16 min.** reinforced hose. An inadequate hose could burst, jeopardizing seriously the safety of the boat.

The hydraulic connections are:

<b>Low pressure connections – max 3 bar</b>	<ul style="list-style-type: none"> <li>• Connection between seawater intake – net filter – non-return valve inlet – pump group</li> </ul>	<b>Armorvin reinforced pipe PN6 with 16mm internal diameter</b>
<b>Medium pressure connections – max 13 bar</b>	<ul style="list-style-type: none"> <li>• Connection between the discharge of the watermaker – through hull discharge fittings of the vessel</li> </ul>	<b>Armorvin reinforced pipe PN6 with 16mm internal diameter</b>
<b>Low pressure connections – max 3 bar</b>	<ul style="list-style-type: none"> <li>• Connections fresh water pressurized system– carbon filter–backflow valve outlet–pump inlet</li> <li>• Connections pump outlet–5 microns filter– watermaker inlet.</li> </ul>	<b>Rubber reinforced pipe PN 16 minimum, internal diameter 16 mm.</b>
<b>Low pressure connections – max 3 bar</b>	<ul style="list-style-type: none"> <li>• Watermaker - fresh water tank</li> </ul>	<b>¼” fittings, Small plastic blue pipe 6x8mm provided within the scope of supply</b>



**PUMP CONNECTIONS:**

Connect the in/out hose to the pump as follows:

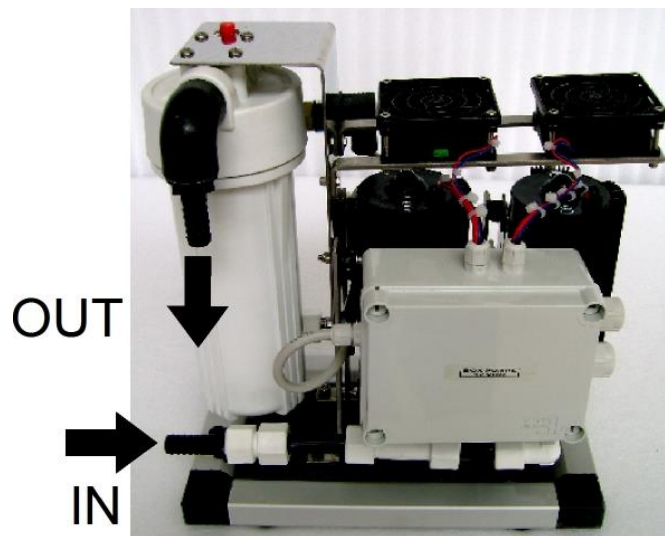

WATERMAKER INTAKE AND DISCHARGE  
FIG. 4-2



**CAUTION**

*The pump has to be placed as close as possible to the seawater intake and as low as possible respect to the seawater level; furthermore, it is recommended to avoid long and windy path of the connection hoses.*





**ATTENTION**

*The use of an improper hose can cause a break which prevent the security of the boat.*

**WATERMAKER CONNECTIONS:**

**WATERMAKER INLET (Sea water inlet from the pump):**

Make use of the external holder located on the left side of the watermaker (marked **IN**).

**WATERMAKER OUTLET (Discharge outboard):**

Make use, for this connection, of the holder located on top of the pressure amplifier, inside the watermaker unit (marked **OUT**). Create a Swan neck upward, when the drain outlet on the vessel is positioned below the watermaker unit, in order to guarantee a water head.



**PRODUCTION FRESH WATER CONNECTION**

The connection has to be made using the small hose supplied with the equipment. The connection has to be made between the polyethylene pipe that comes out the watermaker unit (on the right), and the upper side of the tank, on a 1/4" outlet if available.

It is possible, in case of metal tanks, to make a 1/4" threaded hole to connect the supplied male connector.

Another option is to Tee into the tank air vent hose. This is only possible if the breather pipe section is more than 16 mm. dia. There are no particular limits on the connection length.

## 4.5 Electric connection



### ATTENTION

*These steps have to be performed by a qualified technician/operator, by referring to the electrical drawings provided within this document.*

### 4.5.1 Remote control panel mounting

The remote control panel has the following dimensions:

*width 135 mm    height 116 mm*

It can be fixed on any internal boat panel, provided that the area behind is free of humidity and condense and there is enough depth to house the rear part of the panel (approx. 8 cm.).

The cut to be performed on the boat covering panel, to encase the remote control panel, has the following dimensions:

*width 115 mm    height 97 mm*

The remote control panel can be connected to the Computer box through the pre-wired multiple cable of a 10mt standard length provided. It is possible to adapt the panel to a longer distance by adding a one more cable in series to the one provided.



REMOTE CONTROL PANEL  
fig. 4-3

---

## 4.5.2 Electric connections: wires (SMART 60 12/24V DC)

The electric connectors are positioned inside the small electric box connected to the computer box. The power supply, coming from the service batteries, needs to be connected to the terminals – and + . The connection to the boat panel needs to be performed downstream the voltmeter and the ammeter of the boat panelboard. The connecting terminal must be suitable to support the plant electric load (approx. 250 Watt). A 32 Ampere automatic circuit breaker for 12V DC systems must be installed on the power supply , while a 16 Ampere for 24VDC systems.

The general wires connection scheme (between the external devices and the main electric box) is the following:

Voltage	Automatic switch	Cable lenght					
		up to 3 mts		3 - 7 mt.		7-10 mt.	
Volt	Ampere	mm2	AVG	mm2	AVG	mm2	AVG
12	32	10	7	16	5	25	3
24	16	4	11	4	11	6	9

Electric cables and switches selection table.

### The connection general diagram is the following:

<i>Clamp</i>	<i>Position</i>	<i>connect to</i>	<i>cable section</i>
-	Pump box	negative battery	see table
+	Pump box	positive battery	see table
-	Pump box	Computer box	2,5 mm2
+	Pump box	Computer box	2,5 mm2
P1	Pump box	Computer box	2,5 mm2
P2	Pump box	Computer box	2,5 mm2
PS	Computer box	Signal pressure switch	2,5 mm2
PS	Computer box	Signal pressure switch	2,5 mm2
EV	Computer box	electrovalve (on the AC filter)	2,5 mm2
EV	Computer box	electrovalve (on the AC filter)	2,5 mm2

### Connection between the computer box and remote panel.

Connect the remote panel to the computer box using pre wired cable supplied (standard length 10 mts.)

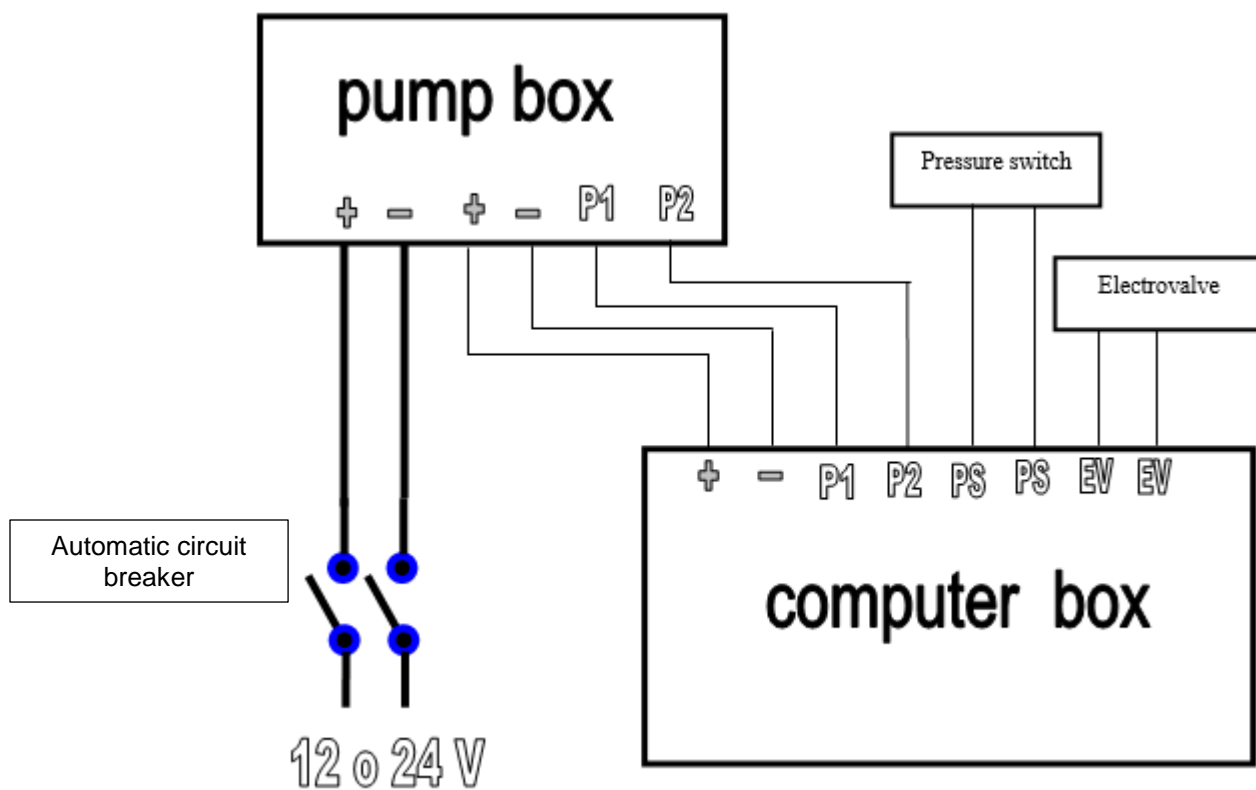

WIRING LOGIC SCHEME 12-24 VDC  
fig. 4-4

## 4.2.1 Electric layout scheme (12/24V DC)

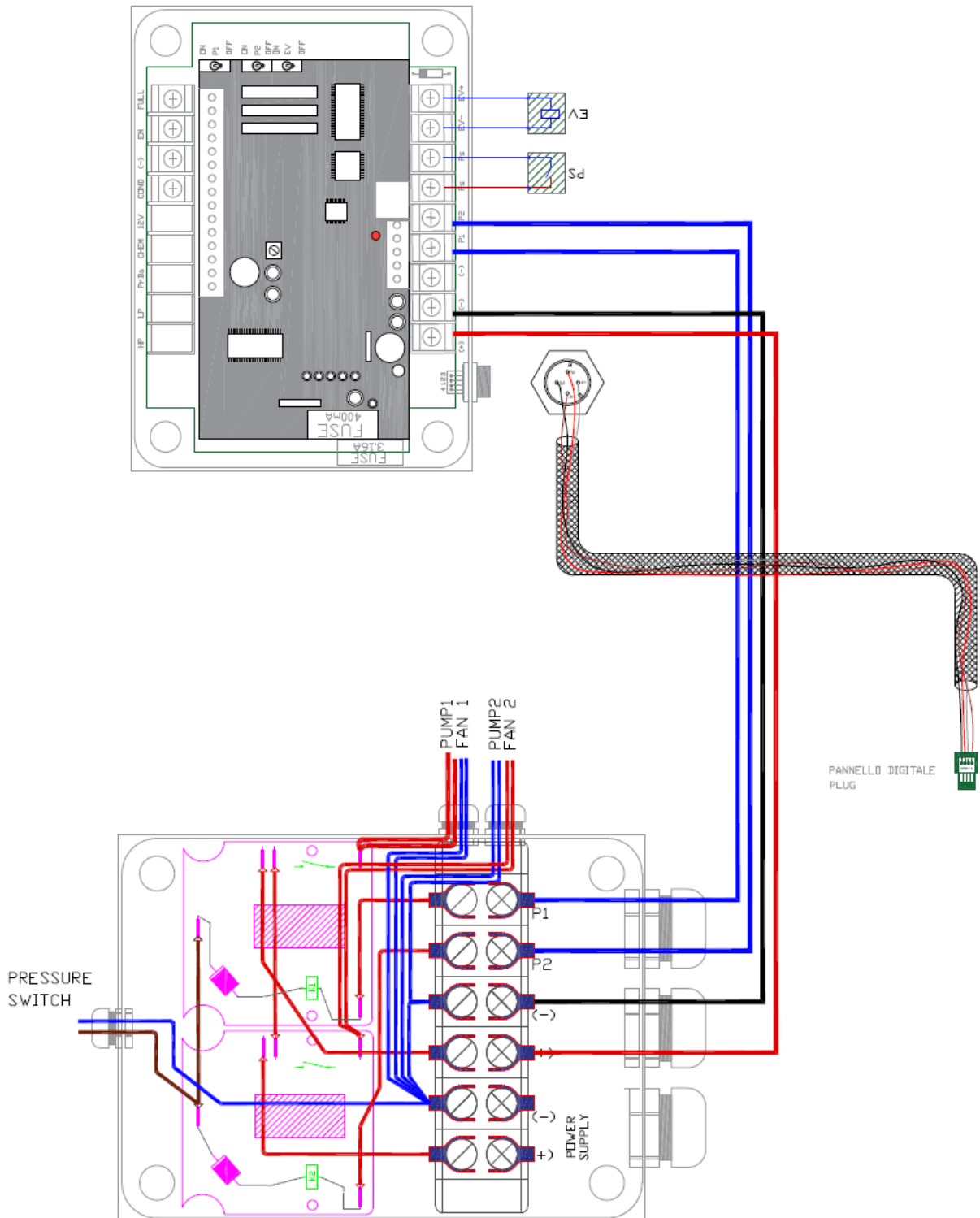

ELECTRIC MAIN BOX SCHEME SMART 60 12/24V DC  
FIG. 4-5

## 5. FUNCTIONING AND USE

### 5.1 Command description



Remote control panel  
Fig. 5.1

#### KEYBOARD FEATURES

The panel keyboard has a total of four push button. The display light switches off after 15 minutes of not use. Pushing any button, the display will light again, without activate any other command. The functions of the push buttons are:

**START** Used to start the system.

If it is pushed shortly the system starts and the unit will run indefinitely until will be pushed STOP.

If it is pushed for at least 3 seconds the system starts, and will stop automatically after the working hours selected with the timer (see menu functions).

It can anyway be stopped before, pushing STOP.

It is used as well to scroll the different options in the single menu.

**STOP** Used to stop the system.

The system, once pushed STOP, usually doesn't stop suddenly. It awaits for the correct positioning of the internal valve (2-3 seconds), and then stops automatically.

If the automatic washing is activated (washing light on), the system, once pushed STOP, will perform the automatic washing (1 min) before stops.

The push button STOP is used as well to exit from the menu function.

**WASHING** Used to rinse the system automatically with fresh water.

If it is pushed shortly the system will get ready to perform an automatic washing (1 minute long) once the system will be stopped.

If it is pushed for at least 3 seconds the system will just perform a 10 minutes rinsing, without suck up sea water.

**MENU** Used to enter into the MENU mode and modify some parameters.

Pushing it repeatedly the different MENU options can be scrolled.

On his turn the START push button allows to scroll the different options of the single menu.

The system recognizes the current value without any further command.

The STOP push button allows to exit from the MENU function.

## MENU OPTIONS

- PUMPS



There are 4 options are available:

- **P1** the system works with pump1 only. In this case the production will be about 30 lit/h and the electric consumption will be about 100 watt.
- **P2** the system works with pump2 only. In this case the production will be about 30 lit/h and the electric consumption will be about 100 watt
- **P1&P2** the system works with one pump only, alternating P1 and P2 every 20 minutes in order to balance the wearing of the two pumps. Even in this case the production will be about 30 lit/h and the electric consumption will be about 100 watt.
- **P1+P2** the system works with both pumps. In this case the production will be about 60 lit/h and the electric consumption will be about 240 watt.

- *WORKING TIME (timer)*



It allows to select the working time of the watermaker (1-6 hours). The timer is activated if the START button is pushed for more than 3 seconds only.

- *LEVEL CONTROL*



It is an optional function. For activating the automatic start/stop from floating switches select the function Level Control to ON. Then exit from menu pushing STOP.

- *BY-PASS*



It allows to exclude the sensor (signal pressure switch) that detects the correct cycling of the ERS. The operation with the by-pass is necessary only in case of malfunctioning of the signal pressure switch (in example if the system gets blocks, with the message " *SYSTEM BLOCKED*", not as consequence of a real hydraulic problem, but just as consequence of the malfunctioning of the probe).

The bypass is used also during special operation like the shut down procedure (washing with chemicals). The bypass activation is automatically removed after one single production cycle. Don't activate the by-pass if not necessary.

- *AUTOMATIC START-UP*



This function activates automatically the first start up procedure. The procedure is necessary when a new machine is started for the first time, or after the filter cartridge replacement, or a general service. The procedure allows to purge completely the air from the system, and from the seawater and the washing fresh water hoses. The depressurization valve must be opened before start the procedure.

- *PERIODIC WASHING*



This function allows a periodic automatic rinsing (every 6 up to 10 days) with fresh water. It can be used before long inactivity periods. The single washing operation will last about 1 minute. The consumed fresh water, for every washing, is about 30 liters. Therefore it is suggested to evaluate if the fresh water reservoir is enough for the programmed cycles. Selecting NO, the function will be disabled.



To activate the function select the days (6 to 10), exit from the menu, pushing STOP, and then push WASHING for 3 seconds. The display will indicate the remaining day before the first rinsing. The function is anyway disabled pushing STOP, or after a normal production cycle.

## MESSAGES

- SYSTEM STANDBY

It indicates that the system is ready to be set and started.

- TOTAL HOURS

It indicates that the total, progressive working time of the watermakers.

- SYSTEM WASHING

It indicates that the unit is in washing mode (pumps and electrovalve on).

- *LOW PRESSURE*



Push STOP to acknowledge the message.

This message means that a LOW block of the machine occurred, and then the pumps have been switched off as a safety procedure. In this case, it is suggested to check the sea water inlet connections.

- *HIGH PRESSURE*



Push STOP to acknowledge the message.

This message means that a high PRESSURE block of the machine occurred, and then the pumps have been switched off as a safety procedure. In this case, it is suggested to perform a reset procedure checking again the functioning of the unit.

- SYSTEM BLOCKED



Push STOP to acknowledge the message.

This message means that an hydraulic block of the machine occurred, and then the pumps have been switched off as a safety procedure. In this case it is suggested to perform a reset procedure and investigate on the possible hydraulic origins of the problem. If the origin of the problem is just a malfunctioning of the signal pressure switch, it is possible to start again the unit, activating the bypass.

- BYPASS WARNING

This message advises or reminds that the unit is working in bypass mode (then some safety functions are disabled).

- CHANGE PUMP FILTERS

This is a blinking message that must be acknowledged pressing the key STOP

This message suggests to replace both 5 and 20 microns filters.

## DISPLAY INDICATIONS DURING PRODUCTION



During the normal functioning of the watermaker the display gives the following indications:

**Pump 1 OFF/ON**

**Pump 2 OFF/ON**

**S = wait** This means that the salinity meter is still completing calculations.

**S = OK** Quality of the produced water good (micro Siemens 0-1500)

**S = MED** Quality of the produced water medium (micro Siemens 1500-2000)

**S = BAD** Quality of the produced water bad (micro Siemens over 2000).

In this last case, please stop the watermaker and schedule a service.

**TIME** It is the time from the starting. If the timer function has been used the time will indicate the remaining time to stop.

## 5.2 Introduction – by pass mode

The watermaker makes use of a bypass mode which disables all the electronic main functioning (diagnosis, automatic washing etc.). In this way the system works manually.

The bypass mode has to be activated only in the following situations:

1. First start-up procedure or restarting of the watermaker after service operation. The bypass is needed to purge the whole residual air which would otherwise be interpreted by the system as a fault, with a consequence of a system block after about 20 sec.
2. Electronic fault. In case of electronic control fault, the bypass mode guarantees the normal functioning of the watermaker manually through the use of the pump1 selector. In this circumstance it is not possible to perform the automatic washing.



### CAUTION

***Please, avoid to use the bypass mode if not strictly necessary. In this mode all the main electronic controls of the watermaker and automatic sensors are disabled.***

## 5.3 First start up procedure

The first start-up procedure is necessary to start a new plant for the first time or to restart it after having performed the laying up procedure.

The purpose of the star up procedure is to essentially purge the air contained in the system.

This procedure has to be performed by making the watermaker functioning manually; this option is carried out by activating the bypass mode, which bypass the electronic controls.



### CAUTION





***When by-pass mode is "ON", all the electronic controls (diagnosis, automatic washing, etc..) are disabled.***

### 5.3.1 Preliminary checks before proceeding with the startup procedure

Please, be sure to perform all the following checks before proceeding with the startup procedure:

1. Verify that all plant components are connected correctly.
2. Verify the 5 micron is installed correctly.
3. Be sure the seawater inlet valve and salt water drain valve are opened (If existing).
4. Be sure the reset valve is closed (lever **orthogonal** to the body valve) and the positioner completely unscrewed.
5. Be sure the fresh water pressurizing pump of the boat is on.
6. Be sure the valve on the active carbon filter is opened.
7. Be sure the fresh water tank is full enough (at least 50lt) to perform washing procedure.

## 5.3.2 Start up

<p>1. Open the depressurization valve (lever horizontal)</p>	
<p>2. Push for 20-30 sec the red button on the active carbon filter housing cup in order to purger the air from the system.</p>	
<p>3. Activate the start up procedure throw the function of the MENU (select the specific function in the menu mode, exit from menu mode pushing STOP, and start the procedure pushing START).</p>	
<p>4. Close the depressurization valve when the display shows the specific message and wait for the completion of the procedure.</p>	

The procedure lasts about 3 minutes, and it can anyway be stopped anytime pushing STOP. After completed the procedure the system is ready to start normally.

## 5.4 Normal operating procedure

Please, be sure to perform all the following checks before proceeding normal operating procedure:

1. Be sure the reset valve is closed (lever **orthogonal** to the body valve) and the positioner completely unscrewed.
2. Be sure the depressurization valve is closed.

### 5.4.1 Normal operating procedure without timer

1. Select the pump mode (P1, P2, P2&P2, or P1+P2) throw the specific pump menu (the system anyway will hold the previous setting, even if the electric power is switched off).
2. Push shortly the button START.

The controller will open the electro-valve, helping the inlet pump hose to get filled with water. After 5 seconds the controller starts the pump.

The display will show the increasing production time.

3. Push the Stop button when finishing the running time needed.

If the washing has been selected, the system will start the washing procedure, and then will stop automatically after around 1 minute.

The fresh water consumed for the automatic washing is about 25 lt.



### 5.4.2 Normal operating procedure with timer

1. Select the pump mode (P1, P2, P2&P2, or P1+P2) throw the specific pump menu (the system anyway will hold the previous setting, even if the electric power is switched off).
2. Select the needed timing (1 to 6 hours) through the specific timer within the menu option (the system will hold as well the previous setting.)
3. Push the button START for more than 3 seconds.

The display will show the decreasing production time. The system will stop when the selected time is reached, and then perform the automatic washing if previously selected.

However, the system can be stopped at any time by pushing STOP.



#### NOTE

***It could occur that the system doesn't stop immediately when stop button is pushed, but it rather stops after a while. This behaviour is absolutely normal because the electronic central unit waits for the hydraulic clock signal before switching off in order to avoid hydraulic system block.***



### CAUTION

*If during normal running operation the computer detects an irregular condition (not constant cycling, low pressure, etc...) the system switches off automatically after 20 sec, and STOP led will start flashing. To make watermaker run again, it is first necessary to press STOP button (in order give a feedback to the system that the issue has been recognized). Before pressing STAR to run the watermaker again, be sure to individuate the cause of the anomaly and solve the issue.*

#### 5.4.3 Single washing operation

To perform a single washing operation, which flushes the system with fresh water for around 10 minutes in order to avoid membranes to remain full of salt for long time, it is necessary to:

- Select the pump mode P1+P2
- Push the WASHING button for more than 3 seconds.

The display will indicate the remaining time. It is possible anyway to stop the operation at anytime by pushing STOP.

#### 5.4.4 Periodic washing

In order to program a periodic washing, which let the system rinsing automatically with a desired frequency, please follow the instruction below:

- Select the days (between 6 and 10) in the “periodic washing” option within the menu
- Exit from the menu by pushing STOP button
- Push the WASHING button for 3 seconds



### NOTE

*In case the power supply is removed, it is necessary to set again the parameter.*

#### 5.4.5 Automatic functioning with level controls (optional)

To activate the automatic start/stop from floating switches, please enter in the menu and set Level Control to ON . Then exit from the menu by pushing STOP.

1. Push START for starting the watermaker, functioning under the floating switches control.

Now the start/stop is under the control of the floating switches. Once the tank is full, the watermaker will be stopped automatically and the message Tank: Full will appear. In this condition the system is in pause.

Once the high level sensor switch off (tank no more totally full) the message AUTO, SYSTEM PAUSE will appear. It means that the system is in a standby mode. In this condition the watermaker can be also restarted manually pushing START.

If not restarted manually, the watermaker will restart automatically when the level in the tank will be very-low.



The watermaker can anyway be stopped at anytime pushing STOP.





Note: in order to avoid false and continuous starts/stops, as consequence of the pitching of the boat, the computer recognizes the command of the level switch only after 60 seconds of stable state.

## 5.5 Reset procedure

If the watermaker get air (or if some other problem occurs), the automatic hydraulic valve may stop in a central position. This means that pressures on both sides of the valve are the same and the unit is effectively stalled. In this case the system has to be manually restarted.

An evidence of this effect is confirmed by a working pressure going up suddenly. After approx. 20 sec. the computer recognizes the problem, turn off the pumps, and the red led start flashing.

This event, besides being very unusual, does not damage the system, but it is necessary to reset the valve with the following simple procedure:

<ol style="list-style-type: none"> <li>1. Turn off the system</li> <li>2. Open the reset valve (lever in horizontal position).</li> </ol>	
<ol style="list-style-type: none"> <li>3. Open the depressurization valve at 45°.</li> </ol>	
<ol style="list-style-type: none"> <li>4. Screw the positioner knob clockwise until it can be moved no further. Normally 10 turns at least are needed.</li> </ol>	
<ol style="list-style-type: none"> <li>5. Unscrew the positioner knob up to the original position, until when it is blocked back.</li> </ol>	



6. Close the reset valve (lever in vertical position).



7. Close the depressurization valve.



8. Restart the system



## 6. MAINTENANCE (ROUTINE AND EXTRAORDINARY)



### 6.1 Control of filter cleaning condition

It is very important to inspect filters condition periodically.

The following filters are present in the system:

1. Net filter (strainer)
2. Pump filter 2 (5 micron cartridge filter – white filter housinh)
3. Active carbon filter

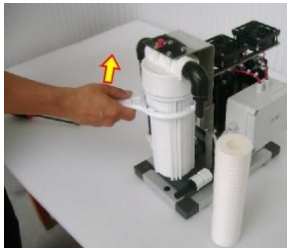
follow the instructions given in the table below:

OPERATION	FREQUENCY	PROCEDURE
Check and cleaning of the strainer	Every 5 days	<p><b>Visual inspection and washing</b></p> 
Replacing of the 5 micron cartridge filters	Every 200 working hourse. Once replaced the filters it is necessary to purge the air from the system, <b>opening for 2-3 minutes the depressurization valve.</b>	<p><b>Unscrew the filter housing cup counter clockwise by using the specific key provided</b></p> 
Replace the active carbon fiber filter	Once per year	<p><b>Unscrew the filter housing cup counter clockwise by using the specific key provided</b></p> 

<p>Purge air from the system periodically by opening for <b>2-3 minutes</b> the <b>depressurization valve at 45°</b>.</p>	<p>Every 15-20 days</p>	
---	-------------------------	--

## 6.2 Check the plant working pressure

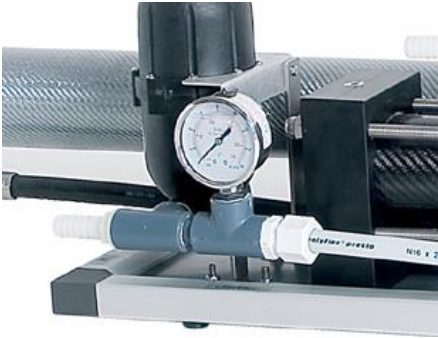
<p>It is necessary to read the pressure on the manometer located on the equipment front panel in order to perform this verification.          The working pressure depends on many factors such as water temperature, salinity level of seawater, effective batteries voltage, membranes cleaning degree, typology of installation.          The pressure, in normal working conditions with both pumps activated, is approx. 6 -7 Bars.          When working with only one pump activated, operating pressure drops at around 5 bar.          There is a small pressure lost head, in the range of 0,2 bar, during the cycle.</p>	
---	---

If the average pressure exceeds the above ranges it is necessary to check the membranes cleaning degree. It is necessary to perform the shutdown procedure if the membranes result dirty. If cleaning also results insufficient it could be necessary to perform an alkaline washing using the chemical product SCHENKER CLEANING 2 (SC2). It is recommended to contact a Schenker certified service center.

## 6.3 Check for absence of leaks

It is necessary to perform this verification at every plant start-up and however often, since possible leaks due to accidental causes (pipe bursting, hose clamp loosening, equipment failure, etc.) may occur, even plentiful, with the consequence of possible damages.

## 6.4 Check for membranes replacement

The reverse osmosis membranes have a 7 years average working life. It is recommended therefore, after 5 years of operation, to verify the possible necessity of substitution and however to perform the substitution after 7 years.

## 6.5 Shutdown procedure

It is necessary to perform the shutdown procedure before standstills longer than 3 months, for instance before the winter laying up.

The purpose of the shutdown is to flush the system from possible organic and inorganic sediments, and inhibit the growth of bacteria that could reduce the reverse osmosis membranes efficiency.

### 6.5.1 Necessary Equipment

The following equipment is necessary to perform the shutdown operation:

1. 1 tank of fill with at least 20 liters of fresh
2. 3 hoses to be connected to:
  - inlet of the pre-pump
  - discharge of the watermaker
  - fresh water production of the watermaker.
3. A bottle of powder **SCHENKER CLEANING 1 (SC1)**. The solution must be prepared following the instruction indicated on the product label, and **using chlorine free water** (water produced by the system can be an option).
4. Tools for dismantling the system's pipes (screwdrivers, pliers, etc.)

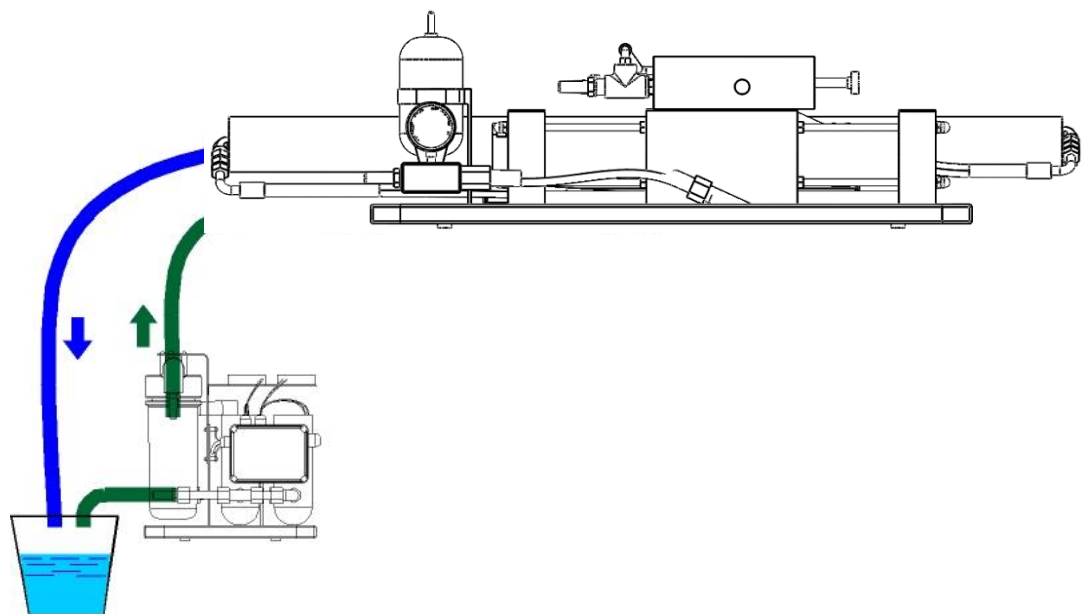

HYDRAULIC SCHEME FOR SHUTDOWN PROCEDURE  
FIG. 6-1



#### NOTE

*The available products for the shutdown procedure are the following:*

*1) SCHENKER CLANING 1 (SC1 – Acid product) to remove the inorganic components and preserve the watermaker during winter break*

*2) SCHENKER CLEANING 2 (SC2 – Alkaline product) to remove the organic components (mould and bacteria) when already deposited; in this case the system becomes stinky.*

*Whether the system needs acid or alkaline cleaning will depend on the type of foulant suspected. However, both kinds of cleaning are needed and it is recommended to start with the alkaline cleaning then follow with the acid cleaning after the system has been flushed.*



#### NOTE

*Normally only SC1 is required, but in case of strong smell it is recommended to use also the SC2.*



*The sequence in this case will be SC2 first, then a washing of the system. Finally the SC1, then again washing of the system.*

*It is advisable to replace the filters after performing shutdown procedure with new ones.*

## 6.5.2 Shutdown operating procedure

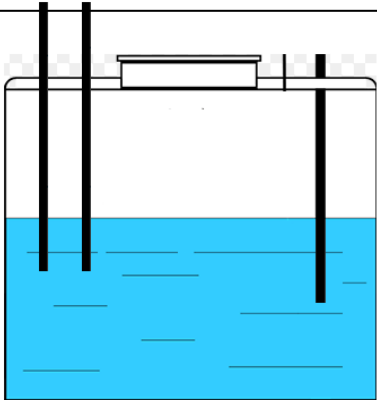
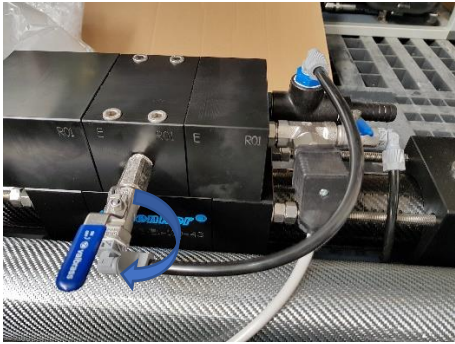
<p>1. Disconnect the production pipe and collect about 20 liters of fresh water within a tank.</p>	
<p>2. Switch off the system by pushing the stop button.</p>	
<p>3. Prepare the solution carefully mixing the bottle of SC1 in about 20 liters of unchlorinated water.</p>	
<p>4. Connect the 3 hoses to the pump group and watermaker as indicated above, and dip them in the solution.</p>	

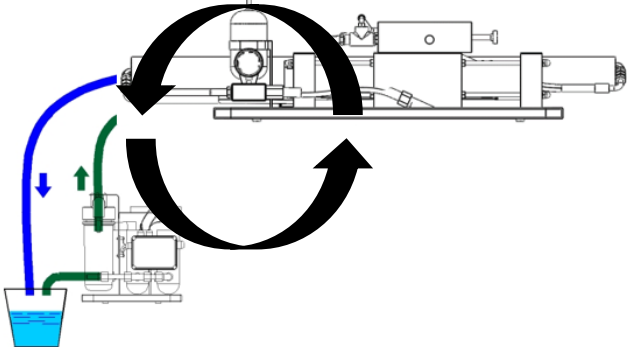
	
<p>5. Check they are well dipped in the solution and don't inhale air.</p>	<p>Pipes under the free water surface</p> 
<p>6. Open the depressurization valve (turn counterclockwise).</p>	
<p>7. Start the watermaker with the by-pass activated (see pag. 32 for bypass activation).</p>	

	
<p>8. Leave the unit running for approx. 20 minutes, checking that the hoses are properly positioned in the recipient, so that to avoid inhaling air.</p>	
<p>9. Shut the plant off and connect the original hoses.</p>	



**CAUTION**

*It is necessary to perform the first start-up procedure when restarting the plant after a shutdown procedure, in order to purge the air and drain out board the chemicals in the systems.*



**CAUTION**

*Avoid inhaling product powders. It is strongly recommended to wear a protective mask during solution preparation.*



## 6.6 Antifreeze procedure (Winterizing procedure in cold climate - under 5°C)

It is recommended to first perform the normal shutdown procedure by using SC1 in order to clean the system properly and prevent bacteria growth and inorganic material deposit.

After this operation, Then the system must be flushed and filled with an antifreeze.

The recommended antifreeze product is a solution of **propylene glycol and unchlorinated water**.

The ideal concentration of propylene glycol is

- 45% (for temperatures up to - 20°)
- 55% (for temperatures up to - 30°).



### ATTENTION

**Do not use ethylene glycol as this substance is toxic and non-degradable.**

The total volume of the solution must be about 15-20 liters.

The procedure is similar to that used for chemical washing with SC1 and SC2 products:

1. **Prepare the solution carefully mixing the propylene glycol with 15-20 liters of unchlorinated water** by following the concentration suggested above.
2. Disconnect the drain hose and the pumps suction hose.
3. Connect two hose pieces to the drain and to the pump suction.
4. **Insert the end side of the hoses into the bucket, verifying that the hoses have been properly dipped in the solution and that they don't inhale air.**
5. **Open the depressurization valve at 45°.**
6. **Start the watermaker with the by-pass activated.**
7. **Leave the unit running for approx. 15 minutes, checking that the hoses are properly positioned in the recipient, so that to avoid inhaling air or spilling the liquid into the boat.**
8. **Shut the plant off and connect the original hoses taking care of not empty the system during out the solution.**

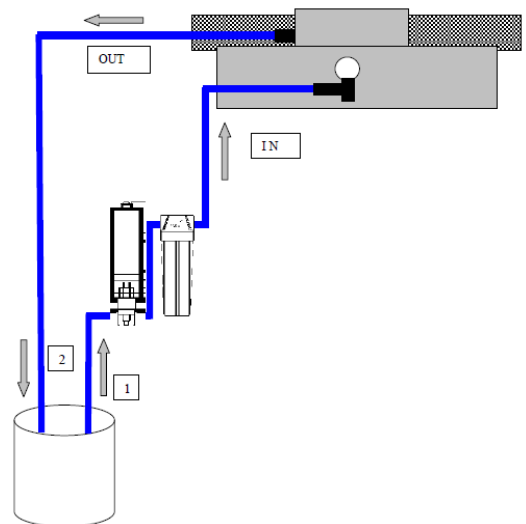

HYDRAULIC SCHEME FOR  
WINTERIZING PROCEDURE  
FIG. 6-2



### ATTENTION

It is necessary to perform the first start-up procedure when restarting the plant after a shutdown procedure, in order to purge the air and drain out board the chemicals in the systems.



**Before proceeding with any kind of service it is strongly recommended to read carefully the instruction contained in this manual.**

## 6.7 Periodic maintenance

### 6.7.1 Membrane replacement

Reverse osmosis membranes have an average lifetime of about 7 years If correctly maintained. It is anyway recommended to check the efficiency of the membranes after 5 years of functioning and verify the needed of a replacement. Please, refer to a certified Schenker service center for this operation.

## 6.8 Adjustments

<p><b>Pump high pressure switch</b></p> <p>The main pump is equipped with a high pressure switch set at around 9,5 Bar. The pressure switch can be calibrated with a 2 mm hexagonal key. To have access to the calibration screw it is necessary to operate on the screw that blocks the electrical connector of the pressure switch, and then introduce the hexagonal key (even without removing the electrical connector itself). Turning the key clockwise increases the calibration of the pressure switch, while turning the key anticlockwise decreases the calibration.</p>	
<p><b>Pulsation dampener</b></p> <p>It is a balder type cylindrical pressure accumulator of air that has the function of damping the pressure oscillations during the commutations of the watermaker. The dampener is factory loaded at a pressure of about 4 bar. The charge level of the dampener must be periodically checked in order to guarantee a correct functioning to the watermaker.</p>	

## 7. TROUBLESHOOTING

### 7.1 Failure chart

<b>Issue</b>	<b>Cause</b>	<b>Remedy</b>
Pump doesn't start	Pump pressure switch disconnected or burned Electronic issue	Restore or replace the pump pressure switch Activate the by-pass
Pump starts but the system suddenly blocks in high pressure	Hydraulic block Dirty filters Obstruct membranes Commutation system block	Perform reset procedure Replace filters Perform washing procedure Contact a customer service
During operation, the pump temporarily switches off, giving rise to a start and stop phenomenon	Pump pressure switch not correctly set Dirty filters or membranes	Set pump pressure switch (see pag.47) Clean or replace
Metal noise of the pump	Pump cavitation	Check the causes of the absence of water flow at the pre-pump inlet
Low production / normal or low pressure	Low battery Air within the system Loss of sealing systems	Check battery charge Purge the air out of the system Contact a customer service
Low production / high pressure (> 9 Bar)	Dirty filters Obstruct membranes Cold inlet water	Replace filters Perform washing procedure Contact a customer service
Loss in the system	Loose fittings ERS leaks	Tighten fittings Contact a customer service

## 7.2 Electronic issues and their solution

- **Pushing the start button the system does not start:**

Check that the by-pass is excluded (selector turned anticlockwise) and that the pumps are activated (pump 1 and pump 2 selectors turned clockwise).

Still the system does not start ...

Check that the system is electrically connected, according to the diagram shown in the manual, and that the main magnetothermal switch is activated.

Still the system does not start ...

Check if power supply to the electrical box arrives, measuring the voltage with a tester between the + and - terminals

If the system starts (the green light of the start button lights up, and after about 20 seconds the system goes into alarm, since the pump is not started) the problem is due to the insufficient battery charge. Charge the batteries and try again.

If the system does not start, check all the electrical connections between the remote panel and microcomputer again and replace the microcomputer box or the connection cable or the remote panel if necessary.

- **Pressing the start button the system starts but goes into alarm after about 25 seconds.**

Check if the watermaker is in hydraulic block (pressure indicated by the pressure gauge above 9-10 bar and pumps off). In this case, carry out the reset procedure indicated in the manual and restart the system.

Still the system does not start (it goes on the block after about 20 seconds).

Disconnect the pressure switch from the terminal board. Activate the system manually by inserting the by-pass. Measure the operation of the pressure switch with a tester in "ohm" position. The pressure switch must give, under normal conditions, a closing signal followed by an opening signal, every 3-4 seconds.

If the signal is always open or always closed, the pressure switch must be replaced

## 8. SUGGESTED SPARE PARTS

### 8.1 Short term cruising

For short term cruising it is advisable to have onboard a cleaning kit (one SC1 and one SC2 cleaning product) as well as one 5 micron cartridge filter. Other additional spares are listed below with their codes:

Spare part name	Code
SC1 WASHING PRODUCT	SC1
SC2 WASHING PRODUCT	SC2
CLEANING KIT BIG (SC1+SC2)	CKBIG
5 MICRON CARTRIDGE 9 3/4"	F5
ACTIVE CARBON FILTER CARTRIDGE	CA

### 8.2 Long term cruising

For long term cruising it is advisable to have onboard a cruising kit (three 5 micron cartridge filter, one active carbon filter, one cleaning kit big) as well as one 2540 SW membrane and a signal pressure switch. Other additional spares are listed below with their codes:

Spare part name	Code
SC1 WASHING PRODUCT	SC1
SC2 WASHING PRODUCT	SC2
CRUISING KIT	CRK136
SPARE PUMP SM-MOD 30/60 12V	SP36/12
SPARE PUMP SM-MOD 30/60 24V	SP36/24
MEMBRANE 2540	M2540
PORTABLE SALINITY TESTER	PST
SIGNAL PRESSURE SWITCH SMART 30/60/80/100	PSSS361
PUMP PRESSURE SWITCH 30/60/50	PSP36
SPARE SEALS KIT 2.0	SS152-2.0



## 8.3 ERS spare parts

N°	DESCRIPTION	Code
1	CENTRAL SECTION BOTTOM PARTS ERS 30_60_80	CCE368
2	MAIN ROD 30_60_80	MRD36
3	CYLINDER END CUP OPEN 30_60_80	CEC/0368
4	PISTON 30_60_80	PST36
5	CARBON FIBRE CYLINDER 30_60_80	CYL36
6	CARBON FIBRE BOTTOM PIPE 30_60_80	CYC
7	CYLINDER END CUP BLIND 30_60_80	CEC36
8	VALVE ROD	VRD
9	RIGHT VALVE 30_60_80_100	RV
10	LEFT VALVE 30_60_80_100	LV
11	CENTRAL VALVE 30_60_80	CV-S36
12	VALVE PISTONS KIT 30_60_80_100	VPK2.0
13	ERS NON RETURN VALVE KIT 30_60_80	ENRV36

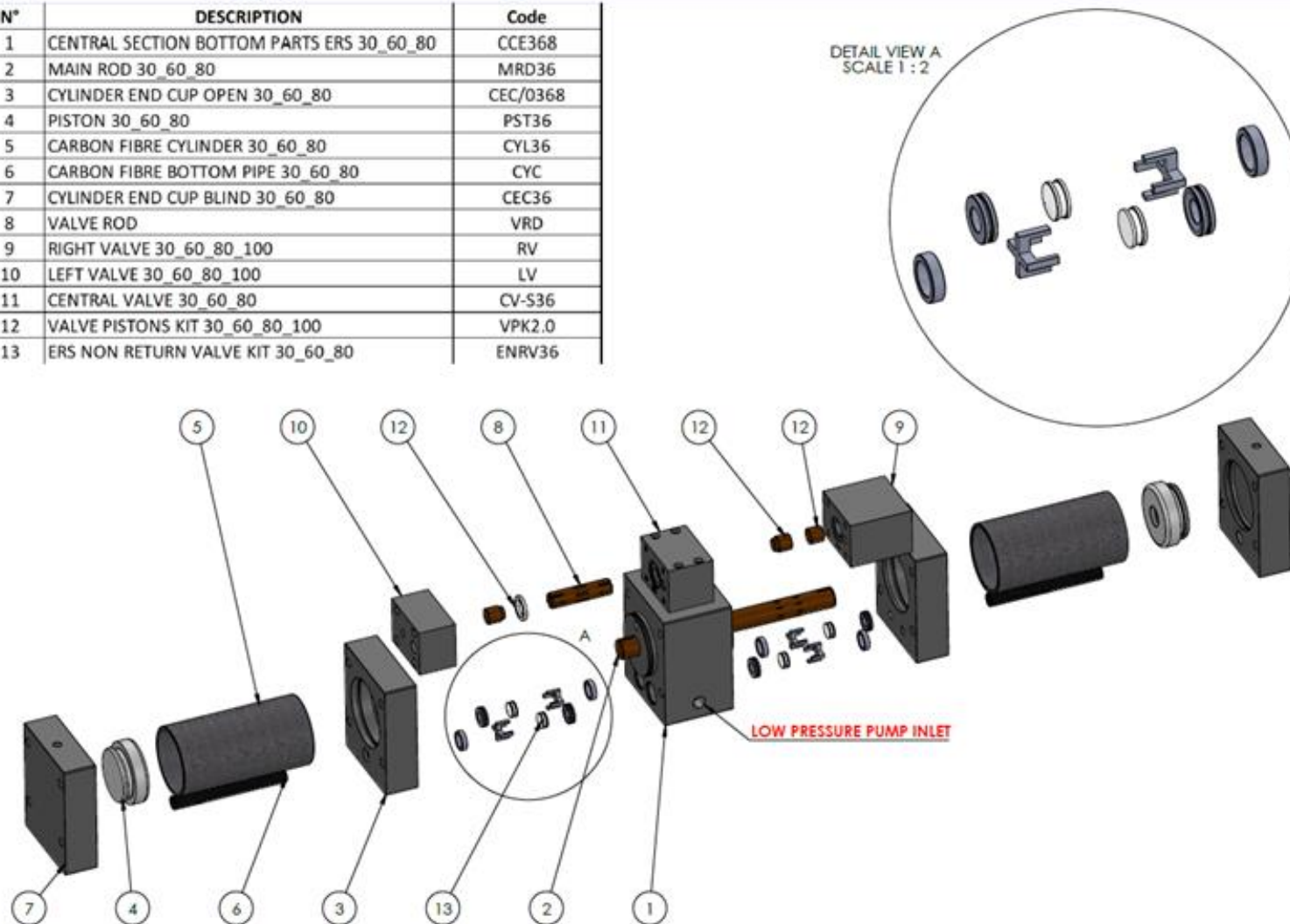

## 8.4 Additional spares

For extraordinary maintenance intervention that might become necessary in order to ensure the normal operating condition of the watermaker, other common spares are listed below with relative images and codes:

Spare part name	Code
COUPLE HIGH PRESSURE HOSE SM 30/60/80	HPH
END CUP VESSEL 2,5" SINGLE CONNECTION	EV2,5
END CUP VESSEL 2,5" DOUBLE CONNECTION	EV2,5-2
MANOMETERS 0-16	M16B

