



Fischer Panda®

Power
wherever
you are™



Manual marine generator

Panda 8000x PMS 230/400 V - 50 Hz - 8 kVA

Panda 10000x PMS 230/400 V - 50 Hz - 10,5 kVA

Super silent technology

Panda_8000x-10000x_PMS_eng.R01.5

26.2.18



Current Revision Status

	Document
Actual:	Panda_8000x-10000x_PMS_eng.R01.5_26.2.18
Replaces:	Panda_6500-10000_xControl_PMS_eng.R01.4

Revision	Page
Generator und Handbuchbezeichnung geändert R01.3	
DC installation überarbeitet R01.4	
Sprache xControl Anhang berichtigt R01.5	

Erstellt durch / created by

Fischer Panda GmbH - Leiter Technische Dokumentation

Otto-Hahn-Str. 32-34

33104 Paderborn - Germany

Tel.: +49 (0) 5254-9202-0

email: info@fischerpanda.de

web: www.fischerpanda.de

Copyright

Duplication and change of the manual is permitted only in consultation with the manufacturer!

Fischer Panda GmbH, 33104 Paderborn, reserves all rights regarding text and graphics. Details are given to the best of our knowledge. No liability is accepted for correctness. Technical modifications for improving the product without previous notice may be undertaken without notice. Before installation, it must be ensured that the pictures, diagrams and related material are applicable to the genset supplied. Enquiries must be made in case of doubt.



Fischer Panda GmbH
 Otto-Hahn-Str. 40
 D-33104 Paderborn
 Germany

Tel. : +49 (0)5254 9202-0
 Fax. : +49 (0)5254 9202-550
 Hotline : +49 (0)5254 9202-767
 Email : info@fischerpanda.de
 Web : www.fischerpanda.de



Inhalt / Contents

Current Revision Status	2
3 General Instructions and Regulations	12
3.1 Safety first!.....	12
3.2 Tools	14
3.3 Manufacturer declaration in accordance with the Machinery Directive 2006/42/EC	16
3.4 Customer registration and guarantee	16
3.4.1 Technical support	16
3.4.2 Caution, important information for start-up!	16
3.5 Safety Instructions - Safety First!	17
3.5.1 Safe operation	17
3.5.2 Observe safety instructions!	17
3.5.3 Personal protective clothing (PPE)	17
3.5.4 Cleanliness ensures safety	17
3.5.5 Safe handling of fuels and lubricants	18
3.5.6 Exhaust fumes and fire protection	18
3.5.7 Safety precautions against burns and battery explosions	19
3.5.8 Protect your hands and body from rotating parts!	19
3.5.9 Anti-freeze and disposal of fluids	19
3.5.10 Implementation of safety inspections and maintenance	20
3.6 Warning and instruction signs.....	20
3.6.1 Special instructions and hazards of generators	20
3.6.1.1 Protective conductor and potential equalisation:.....	21
3.6.1.2 Protective conductor for Panda AC generators:.....	21
3.6.1.3 Switch off all loads while working on the generator	21
3.6.1.4 Potential equalisation for Panda AGT DC generators.....	21
3.6.1.5 Safety instructions concerning cables.....	22
3.6.2 General safety instructions for handling batteries	22
4 In case of Emergency First Aid / Im Notfall - Erste Hilfe	23
4.1 WHEN AN ADULT STOPS BREATHING	24
5 Basics	25
5.1 Intended use of the machine	25
5.2 Purpose of the manual and description of the definitions of the trained persons/operators/users	25
5.2.1 Trained persons	25
5.2.2 Operator/Owner	25
5.2.3 User	26
5.3 Components of the xGenerator	26
5.4 Range of operation	28
5.5 Panda transport box	28
5.5.1 Bolted Fischer Panda transport box	28
5.5.2 Fischer Panda transport box with metal tab closure	28
5.6 Opening the MPL sound insulation capsule	29
5.6.1 Opening the GFK sound insulation capsule	30
5.7 Transport and loading/unloading	30
5.7.1 Transporting the generator	30
5.7.2 Loading/unloading of the generator	30
5.8 Special service instructions and measures for extended machine downtimes and decommissioning	31

Inhalt / Contents

5.8.1	Instructions for the starter battery for extended downtimes	31
5.8.2	Measures for short downtimes	32
5.8.3	Measures for medium term downtimes / hibernation	32
5.8.3.1	Courses for preservation:	32
5.8.3.2	Measures for removing surface protection after medium term downtimes (3 to 6 months). 33	
5.8.4	Measures for extended downtimes / decommissioning	33
5.8.4.1	Courses for preservation:	33
5.8.4.2	Measures for removing surface protection after extended downtimes / recommissioning (over 6 months): 34	
5.9	34
6	The Panda xGenerator	35
6.1	Type plate at the xGenerator	35
6.2	Description of the Generator	36
6.2.1	Right Side View	36
6.2.2	Left Side View	37
6.2.3	Front View	38
6.2.4	Back View	39
6.2.5	View from above	40
6.3	Details of functional units	41
6.3.1	xControl panel	41
6.3.2	The Cooling System - Scheme	42
6.3.3	The Fuel System - Scheme	43
6.3.4	The operation surveillance system	44
6.3.5	The Oil Circuit - Scheme	46
6.4	Remote Control Panel - see separate Control Panel Manual	46
6.4.1	Starting the Generator - see separate Control Panel Manual	46
6.4.2	Stopping the Generator - see separate Control Panel Manual	46
7	Installation Instructions	47
7.1	Personal requirements	47
7.1.1	Hazard notes for the installation	47
7.2	Place of installation	48
7.2.1	Preliminary remark	48
7.2.2	Preparing the base - placement	48
7.2.3	Advice for optimal sound insulation	49
7.3	Generator Connections	49
7.4	Installation of the cooling system - raw water	50
7.4.1	General information	50
7.4.2	Installation of the through hull fitting in Yachts - scheme	50
7.4.3	Quality of the raw water sucking in line	50
7.4.4	Generator installation above waterline	50
7.4.5	Generator installation below waterline	51
7.4.5.1	Raw water installation scheme	52
7.5	Installation of the cooling system - fresh water	53
7.5.1	Position of the external cooling water expansion tank	53
7.6	Ventilation of the coolant circuit / freshwater	53
7.6.1	Pressure Test for Controlling the Cooling Water Circuit	55
7.7	Installation of the water cooled exhaust system	56

Inhalt / Contents

7.7.1	Installation of the standard exhaust system	56
7.8	.Installation of the waterlock	56
7.8.1	Possible cause for water in the exhaust hose	57
7.8.1.1	Possible cause: exhaust hose.....	57
7.8.1.2	Possible cause: cooling water hose	57
7.8.2	Installation area of the waterlock	57
7.8.3	The volume of the waterlock	58
7.8.3.1	Ideal position of the waterlock.....	58
7.8.3.2	Example of the installation of the waterlock off-center and possible effects: ...	60
7.9	Exhaust / water separator	61
7.10	Installation exhaust water separator	62
7.11	Fuel system installation	63
7.11.1	The following items need to be installed:	63
7.11.2	Connection of the fuel lines at the tank	64
7.11.3	Position of the pre-filter with water separator	65
7.12	Ventilating air from the fuel system.....	65
7.13	Generator DC system installation	65
7.13.1	Connection of the starter battery block	65
7.13.2	Connection of the xControl panel - see separate xControl manual	69
7.14	Connection Box – Generator xControl – CB-G	69
7.14.1	xControl ECU	69
7.14.2	FP CAN-Bus for internal use	70
7.14.3	Boostrelay (optional)	70
7.14.4	Line Relay (optional)	70
7.14.5	Autostart (optional)	70
7.14.6	Emergency Stop (optional)	70
7.14.7	Fuel pump	70
7.14.8	Optional DC-OUT	70
7.14.9	FP CAN-Bus RJ45	70
7.15	Generator AC System Installation	71
7.15.1	3-Phase Generator	71
7.15.2	Electronic voltage control xControl	71
7.15.3	Connection to the AC on-board power supply	72
7.15.3.1	Protective conductor	72
7.15.3.2	Electrical fuse.....	72
7.15.3.3	Required cable crosssections	72
7.15.3.4	Disconnecter - power source selector (three way cam switch)	72
7.16	Special recommendations	73
7.16.1	Instructions on prevention of galvanic corrosion	73
7.16.2	Instructions and measures on prevention of galvanic corrosion	73
7.16.3	Isolation test	73
7.17	Initial operation	74
8	Generator operation instruction	75
8.1	Personal requirements.....	75
8.2	Hazard notes for the operation	75
8.3	General operating instruction.....	75
8.3.1	Operation at low temperatures	75
8.3.1.1	Pre-heating the diesel motor	76

Inhalt / Contents

8.3.1.2	Tips regarding starter battery	76
8.3.2	Light load operation and engine idle	76
8.3.2.1	The soot of the generator is due to the fact that:.....	76
8.3.2.2	To prevent the soot of the generator following steps should be observed:	76
8.3.3	Generator load for a longer period and overload	76
8.3.4	Protection conductor:	77
8.3.5	Operating control system on the Fischer Panda generator	77
8.4	Instructions for capacitors - not present at all models.....	77
8.5	Checks before start, starting and stopping the generator	77
8.6	78
9	Maintenance Instructions	79
9.1	Personal requirements	79
9.2	Hazard notes for the maintenance and failure	79
9.3	Environmental protection	81
9.4	Maintenance interval.....	81
9.5	General maintenance instructions	81
9.5.1	Checks before each start	81
9.5.2	Check of Hoses and rubber parts in the sound insulated capsule	81
9.6	Oil Change Intervals	82
9.7	Checking oil-level.....	82
9.7.1	Refilling oil	83
9.7.2	After the oil level check and refilling the oil	83
9.8	Replacement of engine oil and engine oil filter	84
9.8.1	After the oil change	86
9.9	Verifying the starter battery and (if necessary) the battery bank.....	87
9.9.1	Battery	87
9.9.1.1	Check battery and cable connections	87
9.9.1.2	Check electrolyte level	87
9.9.1.3	Check electrolyte density	88
9.10	Checking the water separator in the fuel supply	89
9.10.1	Replace the air filter mat	89
9.10.2	Alternative replacement of the air filter mat with pull out holder	90
9.10.3	Alternative replacement of the air filter at housing with snap fasteners	92
9.10.4	Ventilation of the coolant circuit / freshwater	93
9.10.5	V-belt replacement for the internal cooling water pump	95
9.11	The raw water circuit.....	96
9.11.1	Clean raw water filter	96
9.12	Causes with frequent impeller waste	97
9.12.1	Replacement of the impeller	98
10	Generator Faults	101
10.1	Personal requirements.....	101
10.2	Hazard notes for the troubleshooting.....	101
10.3	Tools and Measuring Instruments	103
10.4	Troubleshooting Table	103
10.4.1	Generator output voltage too low	103
10.4.2	Generator voltage too high (more than 240 V - 50 Hz)	103

Inhalt / Contents

10.4.3	Generator voltage fluctuates	103
10.4.4	Generator not able to start electric motor	103
10.4.5	Diesel motor fails to start	104
10.4.6	Starter is turning motor, but fails to start	104
10.4.7	Motor does not achieve enough speed during starting process	104
10.4.8	Motor runs unsteady	104
10.4.9	Motor speed drops	105
10.4.10	Motor runs in off position	105
10.4.11	Motor stops by itself	105
10.4.12	Sooty, black exhaust	105
10.4.13	Generator must be shut off immediately if:	106
10.5	Overloading the generator	106
10.5.1	Monitoring the Generator Voltage	107
10.5.2	Automatic voltage monitoring and auto-shut down	107
10.6	Generator-Output Voltage is too low	108
10.7	Generator provides no voltage	108
10.7.1	Rotor Magnetism Loss and „Re-magnetising“	108
10.8	Engine Starting Problems	108
10.8.1	Lifting solenoid for motor stop - optional	108
11	Tables.....	111
11.1	Technical data	111
11.2	Fuel.....	111
11.3	Engine oil.....	111
11.3.1	Engine oil classification	111
11.3.1.1	Operating range:	111
11.3.1.2	Quality of oil:	111
11.4	Coolant specifications.....	112
11.4.1	Coolant mixture ratio	113
11.5	Diameter of conduits.....	113
11.6	114
	Panda xControl Manual	115
	Current revision status.....	116
	12 Panda xControl Safety Instructions	117
12.1	Personnel.....	117
12.2	Safety instructions	117
	13 Panda xControl	119
13.1	Components of the xControl	119
13.1.1	xControl - CP-G	119
13.1.2	xControl - GC-S	119
13.1.3	xControl - CB-G	119
13.2	Installation.....	120
13.2.1	Installation of the Electronic Control Unit (ECU) xControl - GC-S	120
13.2.2	Installation of the Connection Box xControl - CB-G	120
13.2.3	Installation of the xControl - CP-G	120
13.3	Operation.....	121

Inhalt / Contents

13.3.1	Switching on the generator	121
13.3.1.1	Overview page with Autostart activated	122
13.3.2	The overview pages	122
13.3.3	Symbols used in overview pages	123
13.4	Starting up the generator	125
13.4.1	Preparations for starting up / Checks (daily) for marine version	125
13.4.2	Preparations for starting up / Checks (daily) for vehicle version	125
13.4.3	Starting up the generator	126
13.4.4	Stopping the generator	127
13.5	The Menu	128
13.5.1	Main Menu	128
13.5.2	Sub-menu: "Panel"	129
13.5.2.1	Setting the illumination of the CP-G	129
13.5.2.2	Setting the contrast of the CP-G	130
13.5.2.3	Setting the standby time of the CP-G	130
13.5.2.4	Setting the standby illumination of the CP-G	130
13.5.2.5	Setting the display mode of the CP-G overview page	130
13.5.2.6	Setting the language of the text pages of the CP-G	131
13.5.2.7	Setting the Temperature Unit	131
13.5.2.8	Setting the Aural Alarm	131
13.5.2.9	Setting the display to flash in the event of a fault	132
13.5.2.10	Setting the Panel Heating	132
13.5.2.11	Setting the display of the optional measurement data	132
13.5.2.12	Resetting all values of the Panel sub-menu to default values	133
13.5.2.13	Return to Main Menu	133
13.5.3	Sub-menu: "Generator"	133
13.5.3.1	Setting the Autostart of the CP-G	134
13.5.3.2	Setting the optional DC output of the CP-G	135
13.5.3.3	Switching the switching outputs of the CP-G	135
13.5.3.4	Reading out the Event Log of the CP-G	136
13.5.3.5	Resetting all values of the Generator sub-menu to the default values	136
13.5.3.6	Returning the Main Menu	136
13.5.4	Resetting the panel language to the default (English)	136
13.5.4.1	How to set the panel language after a reset	137
13.6	Faults	137
13.6.1	Symbols and messages on the display	137
13.6.1.1	Example of message - "Sensor defective"	137
13.6.1.2	Example of message - "Sensor/Cable break"	137
13.6.2	Error code	137
13.6.2.1	Table of Faults	138
13.6.2.2	Description of the symbols	140
13.7	Accessories:	141
13.7.1	Dimensional drawing	142

Inhalt / Contens

Dear Customer,

Thank you for purchasing a Fischer Panda Generator and choosing Fischer Panda as your partner for mobile power on board. With your generator, you now have the means to produce your own power – wherever you are - and experience even greater independence. Not only do you have a Fischer Panda generator on board, you also have worldwide support from the Fischer Panda Team. Please take the time to read this and find how we can support you further.

Installation Approval and Warranty

Every generator has a worldwide warranty. You can apply for this warranty through your dealer when the installation is approved. If you have purchased an extended warranty, please ensure that it is kept in a safe place and that the dealer has your current address. Consult your dealer about warranty options especially if you have purchased a used generator. He will be able to advise about authorised Fischer Panda Services worldwide.

Service and Support

To ensure that your generator operates reliably, regular maintenance checks and tasks as specified in this manual must be carried out. Fischer Panda can supply Service Kits which are ideal for regular servicing tasks. We only supply the highest quality components which are guaranteed to be the RIGHT parts for your generator. Service “Plus” Kits are also available and ideal for longer trips where more than one service interval may be required.

If you require assistance – please contact your Fischer Panda Dealer. Please do not attempt to undertake any repair work yourself, as this may affect your generator warranty. Your dealer will also be able to assist in finding your nearest Fischer Panda service station. Your nearest service station can also be found in our Global Service Network which can be downloaded from our homepage.

Product Registration

Please take the time to register your Fischer Panda Generator on our website at

<http://www.fischerpanda.de/mypanda>

By registering, you will ensure that you will be kept up to date on any technical upgrades or specific information on the operation or servicing of your generator. We can even let you know about new Fischer Panda products – especially helpful if you are planning to upgrade or expand your installation at a later date.

Fischer Panda Quality - Tried and Tested

DIN-certified according DIN ISO 9001

Thank you for purchasing a Fischer Panda Generator.

Your Fischer Panda Team

3. General Instructions and Regulations

3.1 Safety first!

These symbols are used throughout this manual and on labels on the machine itself to warn of the possibility of personal injury or lethal danger during certain maintenance work or operations. Read these instructions carefully.

Can cause acute or chronic health impairments or death even in very small quantities if inhaled, swallowed, or absorbed through the skin.

WARNING: Hazardous materials



This warning symbol draws attention to special warnings, instructions or procedures which, if not strictly observed, may result in damage or destruction of equipment.

WARNING: Important information!



Warning of materials that may ignite in the presence of an ignition source (cigarettes, hot surfaces, sparks, etc.).

WARNING: Fire hazard



In the environment described / during the work specified, smoking is prohibited.

PROHIBITED: No smoking



Fire and naked light are ignition sources that must be avoided.

PROHIBITED: No fire or naked light



The equipment shall not be activated or started up while work is in progress.

PROHIBITED: Do not activate/start up



Touching of the corresponding parts and systems is prohibited.

PROHIBITED: Do not touch



Danger for life! Working at a running generator can result in severe personal injury.

DANGER: Automatic start-up



The generator can be equipped with a automatic start device. This means, an external signal may trigger an automatic start-up. To avoid an unexpected starting of the generator, the starter battery must be disconnected before working at the generator.

This danger symbol refers to the danger of electric shock and draws attention to special warnings, instructions or procedures which, if not strictly observed, may result in severe personal injury or loss of life due to electric shock.

WARNING: Hazardous electric voltage



General warning of a hazard area

WARNING: General warning



Can cause acute or chronic health impairments or death even in very small quantities if inhaled or ingested.

WARNING: Danger due to inhalation and/or ingestion



Warning of live parts that may cause electric shock upon contact. Especially dangerous for persons with heart problems or pacemakers.

WARNING: Risk of electric shock upon contact



Danger of injury due to being pulled into equipment. Bruising and torn off body parts possible. Risk of being pulled in when touching with body part, loose-fitting clothing, scarf, tie, etc.

WARNING: Danger due to rotating parts



Warning of substances that may cause an explosion under certain conditions, e.g. presence of heat or ignition sources.

WARNING: Explosion hazard



Warning of hot surfaces and liquids. Burn/scalding hazard.

WARNING: Hot surface



Warning of substances that cause chemical burns upon contact. These substances can act as contaminants if introduced into the body.

WARNING: Danger due to corrosive substances, potential contamination of person



When the system is opened, the pressure can be relieved abruptly and expel hot gases and fluids. Risk of injury due to parts flying about, burn hazard due to liquids and gases.

WARNING: System may be pressurised!



Warning of hearing damages.

WARNING: Hearing damage



Warning of magnetic field.

WARNING: Magnetic field



Warning of overpressure.

WARNING: Overpressure



Wearing the applicable snugly fitting protective clothing provides protection from hazards and can prevent damage to your health.

MANDATORY INSTRUCTION: Wear snugly fitting protective clothing (PPE).



Wearing hearing protection provides protection from acute and gradual hearing loss.

MANDATORY INSTRUCTION: Wear hearing protection (PPE).



Wearing safety goggles protects the eyes from damage. Optical spectacles are not a replacement for the corresponding safety goggles.

MANDATORY INSTRUCTION: Wear safety goggles (PPE).



Wearing protective gloves provides the hands from hazards like friction, graze, punctures or deep cuts and protects them from contact with hot surfaces.

MANDATORY INSTRUCTION: Wear protective gloves (PPE).



Compliance with the instructions in the manual can avert danger and prevent accidents. This will protect you and the generator.

MANDATORY INSTRUCTION: Observe the instructions in the manual.







Environmental protection saves our living environment. For you and for your children.





MANDATORY INSTRUCTION: Comply with environmental protection requirements.



3.2 Tools

These symbols are used throughout this manual to show which tool must be used for maintenance or installation.

	Spanners W.A.F X = width across flats of X mm
	Hook wrench for oil filter
	Screw driver, for slotted head screws and for Phillips head screws
	Multimeter, multimeter with capacitor measuring unit

	<p>Socket wrench set</p>
	<p>Hexagon socket wrench set</p>
	<p>Clamp-on ammeter (DC for synchronous generators; AC for asynchronous generators)</p>
	<p>Torque wrench</p>

3.3 Manufacturer declaration in accordance with the Machinery Directive 2006/42/EC

Manufacturer declaration in accordance with the Machinery Directive 2006/42/EC

The generator was designed in such a way that all assemblies correspond with the CE guidelines. If Machinery Directive 2006/42/EC is applied, then it is forbidden to start the generator until it has been ascertained that the system into which the generator is to be integrated also complies with the Machinery Directive 2006/42/EC. This includes the exhaust system, cooling system and electrical installations.

The evaluation of "protection against contact" must be carried out when installed, in conjunction with the respective system. This also includes correct electrical connections, a safe ground wire connection, foreign body and humidity protection, protection against moisture due to excessive condensation, as well as overheating through appropriate and inappropriate use of the equipment in its installed state. The responsibility for implementing these measures lies with those who undertake the installation of the generator in the final system.

3.4 Customer registration and guarantee

Use the advantages of registering your product:

- you will receive a Guarantee Certificate after approval of your installation data
- you will receive extended product information that may be relevant to safety.
- You will receive free upgrades as necessary.

Additional advantages:

Based on your complete data record, Fischer Panda technicians can provide you with fast assistance, since 90 % of the disturbances result from defects in the periphery.

Problems due to installation errors can be recognized in advance.

3.4.1 Technical support

Technical Support via the Internet: info@fischerpanda.de

3.4.2 Caution, important information for start-up!

1. The commissioning log shall be filled in immediately after initial operation and shall be confirmed by signature.
2. The commissioning log must be received by Fischer Panda GmbH at Paderborn within 4 weeks of initial operation.
3. After receiving the commissioning log, Fischer Panda will make out the official guarantee certificate and send it to the customer.
4. If warranty claims are made, the document with the guarantee certification must be submitted.

If the above requirements are not or only partly fulfilled, the warranty claim shall become void.

3.5 Safety Instructions - Safety First!

3.5.1 Safe operation

Careful handling of the equipment is the best insurance against an accident. Read the manual diligently, and make sure you understand it before starting up the equipment. All operators, regardless of their experience level, shall read this manual and additional pertinent manuals before commissioning the equipment or installing an attachment. The owner shall be responsible for ensuring that all operators receive this information and are instructed on safe handling practices.



3.5.2 Observe safety instructions!

Read and understand this manual and the safety instructions on the generator before trying to start up and operate the generator. Learn the operating practices and ensure work safety. Familiarise yourself with the equipment and its limits. Keep the generator in good condition.

3.5.3 Personal protective clothing (PPE)

For maintenance and repair work on the equipment, **do not** wear loose, torn, or ill-fitting clothing that may catch on protruding parts or come into contact with pulleys, cooling disks, or other rotating parts, which can cause severe injury.



Wear appropriate safety and protective clothing during work.

Do not operate the generator while under the influence of alcohol, medications, or drugs.



Do not wear head phones or ear buds while operating, servicing, or repairing the equipment.



3.5.4 Cleanliness ensures safety

Keep the generator and its environment clean.

Before cleaning the generator, shut down the equipment and secure it against accidental start-up. Keep the generator free from dirt, grease, and waste. Store flammable liquids in suitable containers only and ensure adequate distance to the generator. Check the lines regularly for leakage and eliminate leaks immediately as applicable.



3.5.5 Safe handling of fuels and lubricants

Keep fuels and lubricants away from naked fire.

Before filling up the tank and/or applying lubricant, always shut down the generator and secure it against accidental start-up.



Do not smoke and avoid naked flame and sparking near fuels and the generator. Fuel is highly flammable and may explode under certain conditions.

Refuel in well-ventilated open spaces only. If fuel/lubricant was spilled, eliminate fluids immediately.

Do not mix diesel fuel with petrol or alcohol. Such a mixture can cause fire and will damage the generator.



Use only approved fuel containers and tank systems. Old bottles and canisters are not adequate.

3.5.6 Exhaust fumes and fire protection

Engine fumes can be hazardous to your health if they accumulate. Ensure that the generator exhaust fumes are vented appropriately (leak-proof system), and that an adequate fresh air supply is available for the generator and the operator (forced ventilation).



Check the system regularly for leakage and eliminate leaks as applicable.

Exhaust gases and parts containing such fumes are very hot; they may cause burns under certain circumstances. Always keep flammable parts away from the generator and the exhaust system.

To prevent fire, ensure that electrical connections are not short-circuited. Check regularly that all lines and cables are in good condition and that there is no chafing. Bare wires, open chafing spots, frayed insulation, and loose cable connections can cause dangerous electric shocks, short-circuit, and fire.



The generator shall be integrated in the existing fire safety system by the operating company.

CALIFORNIA

Proposition 65 Warning

Diesel engine exhaust and some of its constituents are known to the State of California to cause cancer, birth defects, and other reproductive harm.



3.5.7 Safety precautions against burns and battery explosions

The generator and its cooling agents and lubricants as well as the fuel can get hot while the generator is operated. Use caution around hot components such as parts containing exhaust fumes, radiator, hoses, and engine block during operation and after the generator was shut down.



The cooling system may be pressurised. Open the cooling system only after letting the engine and the coolant cool down. Wear appropriate protective clothing (e.g. safety goggles, gloves).



Prior to operation, ensure that the cooling system is sealed and that all hose clamps are tightened.

The battery represents an explosion hazard, this applies both to the starter battery and the battery bank of the AGT generators. While batteries are being charged, a hydrogen-oxygen mixture is generated, which is highly explosive (electrolytic gas).



Do not use or charge batteries if the fluid level is below the MINIMUM marking. The life span of the battery is significantly reduced, and the risk of explosion increases. Refill to a fluid level between maximum and minimum level without delay.

Especially during charging, keep sparks and naked fire away from the batteries. Ensure that the battery terminals are tightly connected and not corroded to avoid sparking. Use an appropriate terminal grease.



Check the charge level with an adequate voltmeter or acid siphon. Contact of a metal object across the terminals will result in short-circuiting, battery damage, and high explosion risk.

Do not charge frozen batteries. Heat the batteries to +16 °C (61 °F) prior to charging.

3.5.8 Protect your hands and body from rotating parts!

Always keep the capsule closed while operating the generator.

To check the V-belt tension, always shut down the generator.



Keep your hands and body away from rotating parts such as V-belt, fans, pulleys, and flywheel. Contact can cause severe injury.

Do not run the engine without the safety devices in place. Prior to start-up, mount all safety devices securely and check for proper attachment and function.

3.5.9 Anti-freeze and disposal of fluids

Anti-freeze contains toxic substances. To prevent injury, wear rubber gloves and wash off any anti-freeze immediately in case of skin contact. Do not mix different anti-freeze agents. The mixture may cause a chemical reaction generating harmful substances. Use only anti-freeze that was approved by Fischer Panda.



Protect the environment. Collect drained fluids (lubricants, anti-freeze, fuel), and dispose of them properly. Observe the local regulations for the respective country. Ensure that no fluids (not even very small quantities) can drain into the soil, sewers, or bodies of water.



3.5.10 Implementation of safety inspections and maintenance

Disconnect the battery from the engine before performing service work. Affix a sign to the control panel - both the main and the corresponding slave panel - with the instruction "DO NOT START UP - MAINTENANCE IN PROGRESS" to prevent unintentional start-up.



To prevent sparking due to accidental short-circuiting, always remove the earthing cable (-) first and reconnect it last. Do not start work until the generator and all fluids and exhaust system parts have cooled down.

Use only suitable tooling and appliances and familiarise yourself with their functions to prevent secondary damage and/or injury.



Always keep a fire extinguisher and a first aid box handy while performing maintenance work.

3.6 Warning and instruction signs

Keep warning and instruction signs clean and legible.

Clean the signs with water and soap and dry them with a soft cloth.

Immediately replace damaged or missing warning and instruction signs. This also applies to the installation of spare parts.

3.6.1 Special instructions and hazards of generators

The electrical installations may only be carried out by trained and qualified personnel!



The generator must not be operated with the cover removed.

If the generator is being installed without a sound insulation capsule, it must be ensured that all rotating parts (belt-pulley, belts etc.) are covered and protected so that there is no danger to life and body!



If a sound insulation covering will be produced at the place of installation, then easily visible signs must show that the generator must only be switched on while the capsule is closed.



All servicing, maintenance, or repair work may only be carried out when the motor is not running.

Electrical voltages above 50 volts are always dangerous to life. The rules of the respective regional authority must be adhered to during installation. For safety reasons, only an electrician may carry out the installation of the electrical connections of the generator.

3.6.1.1 Protective conductor and potential equalisation:

Electric voltage above 50 V may be life-threatening. For this reason systems are grounded with a protective conductor. In connection with a RCD the current supply will be disconnected in case of a failure.

Appropriate safety precautions like the RCD and corresponding fuses have to be provided by the customer to guarantee a safe operation of the generator.

3.6.1.2 Protective conductor for Panda AC generators:

The generator is „earthed“ as a standard (centre and ground are interconnected in the generator terminal box by a shunt). This is a basic first-level safety measure, which offers protection as long as no other measures are installed. Above all, it is designed for delivery and a possible test run.



This „neutralisation“ (Protective Earthing Neutral - PEN) is only effective if all parts of the electrical system are jointly „earthed“ to a common potential. The shunt can be removed if this is necessary for technical reasons and another protective system has been set up instead.

While the generator is being operated, the full voltage is applied to the AC control box, as well. Therefore, it is essential to ensure that the control box is closed and secured against touch while the generator is running.



The battery must always be disconnected if work on the generator or electrical system is to be carried out, so that the generator cannot be started up unintentionally.

3.6.1.3 Switch off all loads while working on the generator

All loads must be disconnected prior to working on the generator to avoid damage to the devices. In addition, the semiconductor relays in the AC control box must be disconnected in order to avoid the booster capacitors being activated during set-up. The negative terminal of the battery must be disconnected.

Capacitors are required to run the generator. These have two varying functions:

- A) The working capacitors
- B) The booster capacitors

Both groups are located in a separate AC control box.

Capacitors store electrical energy. High voltages may remain across the capacitor contacts even after they have been disconnected from the mains. As a safety precaution, do not touch the contacts. If the capacitors must be replaced or inspected, the contacts shall be short-circuited by connecting an electrical conductor to discharge potentially remaining potential differences.

If the generator is switched off normally, the working capacitors are automatically discharged via the winding of the generator. The booster capacitors are discharged by means of internal discharge resistors.

For safety reasons, all capacitors must be discharged through short-circuiting before work is carried out on the AC control box.

3.6.1.4 Potential equalisation for Panda AGT DC generators

For further information specific to your generator, see the chapter installation.

3.6.1.5 Safety instructions concerning cables

Cable types

It is recommended to use cables that are in compliance with the standard UL 1426 (BC-5W2) with type 3 (ABYC section E-11).

Cable cross-section







The cable shall be selected taking into account the amperage, cable type, and conductor length (from the positive power source connection to the electrical device and back to the negative power source connection).

Cable installation


It is recommended to install a self-draining cable conduit classified as V-2 or higher in compliance with UL 94 in the area of the cable guide inside the capsule. It must be ensured that the cable guide is not routed along hot surfaces such as the exhaust manifold or the engine oil drain screw but instead is installed free from any influence due to friction and crushing.

3.6.2 General safety instructions for handling batteries

These instructions shall apply in addition to the instructions of the battery manufacturer:

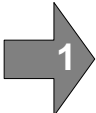
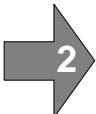
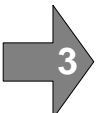

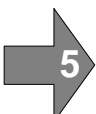
- While you are working on the batteries, a second person should be within earshot to help you if necessary. 
- Keep water and soap ready in case battery acid is burning your skin.
- Wear eye protection and protective clothing. Do not touch your eyes while handling batteries.
- If you have acid splashes on the skin or clothing, wash them out with lots of water and soap.
- If acid sprays into your eyes, immediately flush them with clean water until no more burning is felt. Immediately seek medical assistance. 
- Do not smoke near the batteries. Avoid naked fire. The area around batteries is a potentially explosive atmosphere.
- Ensure that no tools are dropped on the battery terminals; cover them as necessary.
- Do not wear jewellery or watches on your arms during installation that might short-circuit the battery. Otherwise, there is a risk of skin burns. 
- Protect all battery contacts against accidental contact.
- For battery banks: Use only deep cycle batteries. Starter batteries are not suitable. Lead-acid gel batteries are recommended. They are maintenance-free, cycle stable, and do not release gases. 
- Never charge a frozen battery.
- Avoid battery short-circuits.
- Ensure proper ventilation of the battery to vent gases that may be released.
- Battery connection terminals must be checked for proper seating before operation. 
- Battery connection cables shall be installed with utmost care and shall be checked for excessive heating under load. Check the battery near vibrating components regularly for chafing and insulation defects. 

ATTENTION! For battery charger generators (Fischer Panda AGT-DC)!

Prior to installation, verify that the voltage of the battery bank complies with the output voltage of the generator. 

4. In case of Emergency First Aid / Im Notfall - Erste Hilfe



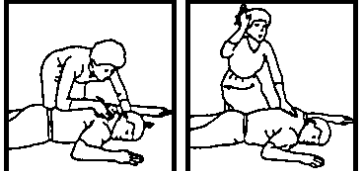
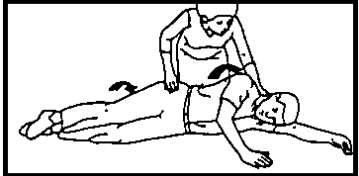
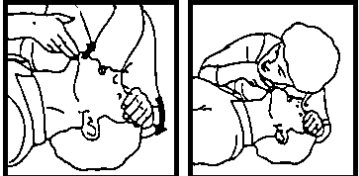


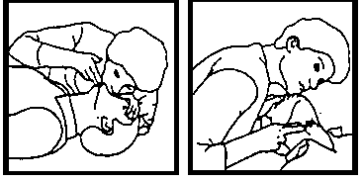
	<p>First Aid in case of accidents by electrical shocks</p> <p>5 Safety steps to follow if someone is the victim of electrical shock</p>	
	Do not touch the injured person while the generator is running.	
	Switch off the generator immediately.	
	If you cannot switch off the generator, pull, push, or lift the person to safety using a wooden pole, rope or some nonconducting material.	
	Call an emergency doctor as soon as possible.	
	Immediately start necessary first aid procedures.	

4.1 WHEN AN ADULT STOPS BREATHING

DO NOT attempt to perform the rescue breathing techniques provided on this page, unless certified. Performance of these techniques by uncertified personnel could result in further injury or death to the victim.

Warning:



<p>1 Does the Person Respond? Tap or gently shake victim. Shout, "Are you OK?"</p>		<p>2 Shout, "Help!" Call people who can phone for help.</p>
<p>3 Roll Person onto Back. Roll victim towards you by pulling slowly.</p>		
<p>4 Open Airway. Tilt head back, and lift chin. Shout, "Are you OK?"</p>		<p>5 Check for Breathing. Look, listen, and feel for breathing for 3 to 5 seconds.</p>
<p>6 Give 2 Full Breaths. Keep head tilted back. Pinch nose shut. Seal your lips tight around victim's mouth. Give 2 full breaths for 1 to 1½ seconds each.</p>		
<p>7 Check for Pulse at side of Neck. Feel for pulse for 5 to 10 seconds.</p>		<p>8 Phone EMS for Help. Send someone to call an ambulance.</p>
<p>9 Begin Rescue Breathing. Keep head tilted back. Lift chin. Pinch nose shut. Give 1 full breath every 5 seconds. Look, listen, and feel for breathing between breaths.</p>		<p>10 Recheck Pulse Every Minute. Keep head tilted back. Feel for pulse for 5 to 10 seconds. If victim has pulse, not breathing, continue rescue breathing. If no pulse, begin CPR.</p>

5. Basics

5.1 Intended use of the machine

The Fischer Panda generator is made to produce electrical energy out of diesel fuel.

The diesel fuel is converted to mechanical energy by the diesel engine. This mechanical energy drives the generator. In the genset, the mechanical energy is converted to electrical energy. This process is controlled by (sometimes external) components, the remote control panel and the voltage control system.

Sufficient amount of fuel and combustion air is necessary for this process. Arising exhaust and heat must be conducted according to the specification.

If the electrical power is fed to a local net, the regulations and installation instructions of the system operator and the regional authorities with reference to the power network/shipboard power supply system must be respected. Safety applications and safety devices (including lightening conductor, personal protection switch, ect.) have to be installed.

Misapplication of the product can damage and destroy the product and the electrical net inclusive all load which is attached to the net, and contain hazards like short circuit, ect. It is not allowed to modify the product in any case. Never open the sound cover during operation! The safety and hazard notes of the manual must be respected!

5.2 Purpose of the manual and description of the definitions of the trained persons/operators/users

This manual contains the working instructions and operating guidelines for the owner and user of Fischer Panda generators.

The manual is the base and the guideline for the correct installation and maintenance of Fischer Panda generators. It does not substitute the technical evaluation and should be used as an example guide only. The installation must be undertaken and proved by a suitable qualified/trained person and should be in accordance with the law as required by the country and special situation. All work has to be undertaken according to the state of the technology.

5.2.1 Trained persons

Qualified persons for the mechanical components are motor mechanics or persons with similar qualification and training.

Trained persons for the electrical components are electricians or persons with similar qualification and training.

After the installation the trained person has to instruct the operator/owner about the operation and maintenance of the generator. This must include the hazards of the generator use.

5.2.2 Operator/Owner

The operator is responsible for the operation of the generator.

After the installation, the operator/owner must be instructed concerning the operation and maintenance of the generator. This has to include the hazards during operation of the generator, different operating conditions, and instructions for the maintenance.

The operator/owner must read and follow the manual and must respect the hazard notes and safety instructions.

5.2.3 User

Users are persons, established by the operator/owner, to operate the generator.

The operator/owner has to ensure that the user has read and understood the manual and that all hazard notes and safety instructions are respected. The user must be instructed by the operator/owner regarding his activity at the generator, especially concerning the maintenance.

5.3 Components of the xGenerator

1. Panda xGenerator

representative picture

Fig. 5.3-1: Panda xGenerator



2. Control Panel Panda xControl

representative picture

Fig. 5.3-2: xControl panel

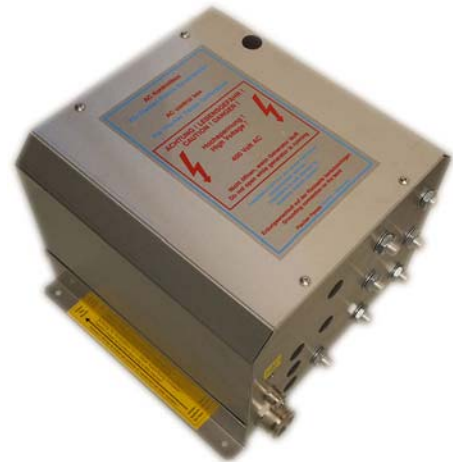


3. AC-Control Box

representative picture

Not present at all models

Fig. 5.3-3: AC-Control box



4. FP- Bus cable 15 mtr

Fig. 5.3-4: FP- Bus cable 15 mtr



5. Termination resistor

Fig. 5.3-5: Termination resistor



6. Fischer Panda manual

The Fischer Panda manual comprises the following components:

- a.- Transparent envelope with general information, warranty terms, installation certificates, and service list.
- b.- Generator manual
- c.- Spare parts catalogue „Installation & Service Guide“
- d.- Engine manual from the engine manufacturer
- e.- Generator circuit diagram

representative picture

Fig. 5.3-6: Manual



5.4 Range of operation

Reliable power supply on vehicles.

5.5 Panda transport box

5.5.1 Bolted Fischer Panda transport box

1. Remove the bolts for cover / sidewalls
2. Remove the cover
3. Remove the loose accessories
4. Remove the bolts for sidewalls / floor pallet
5. Remove the sidewalls
6. Open the generator attachment

5.5.2 Fischer Panda transport box with metal tab closure

1. Bend up the metal tab closures on the transport box lid
2. Remove the cover
3. Remove the loose
4. Bend open the metal tab closures at the bottom of the transport box
5. Remove the sidewalls
6. Open the generator attachment

5.6 Opening the MPL sound insulation capsule

To open the sound insulation capsule, the closures must be rotated roughly 180° counter-clockwise. Use a flat head screwdriver. Pull the sidewalls out by gripping into the slots.



Closure locked

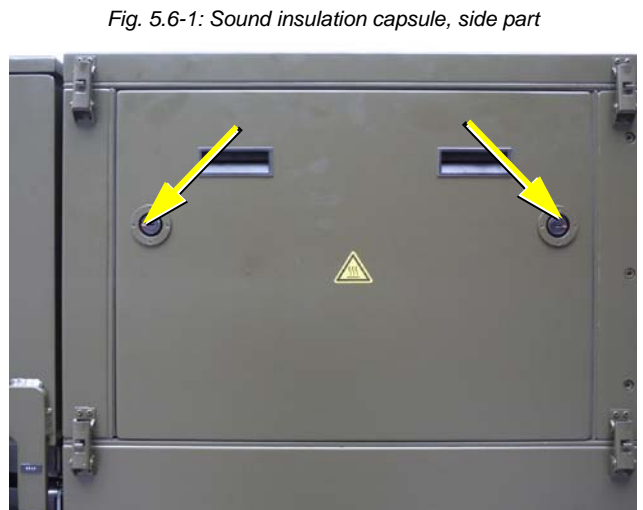


Fig. 5.6-1: Sound insulation capsule, side part

Fig. 5.6-2: Closure locked



Closure open

Fig. 5.6-3: Closure open



5.6.1 Opening the GFK sound insulation capsule

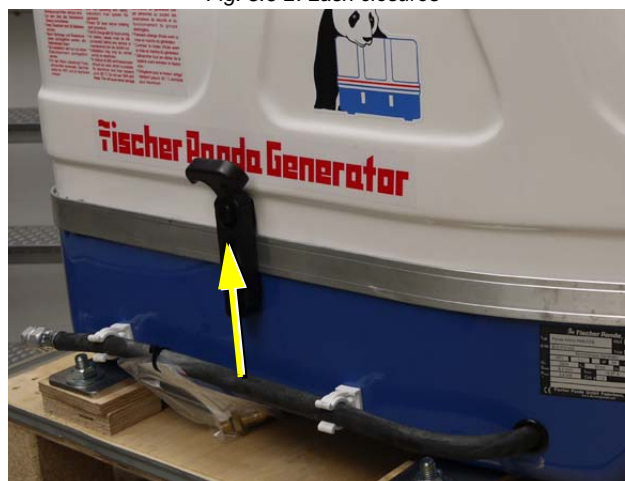
GFK sound insulation capsule with lash closures

Fig. 5.6-1: Lash closures



To open the lash closures pull the handle in arrow direction and lift the lash of the closure pin. After lifting off the lashes, the sound isolation cover upper part can be removed.

Fig. 5.6-2: Lash closures



5.7 Transport and loading/unloading

5.7.1 Transporting the generator

- The generator must always be upright for transport.
- For transport, the Fischer Panda transport box shall be used for the generator. The generator shall be securely attached to the bottom of the box.
- For loading/unloading, an adequate industrial truck shall be used.
- Depending on the transport distance (e.g. air cargo), the generator fluids (coolant, engine oil, fuel) may have to be drained. The corresponding instructions and warnings must be fitted to the transport packaging.

5.7.2 Loading/unloading of the generator

For loading/unloading the generator, appropriate ring eye bolts shall be installed in the holes in the support rails. The load bearing capacity of each ring eye bolt must at least equal the generator weight.

An adequate lifting yoke shall be used for transport/ loading.

Fig. 5.7.2-1: Lifting yoke (example)



5.8 Special service instructions and measures for extended machine downtimes and decommissioning

The decommissioning and storage must be undertaken and proved regarding the operation and storage situation.

Note:



Fischer Panda takes no responsibility for damages through wrong decommissioning and storage.

Downtimes are categorised in the following groups:

- Short downtime (1 to 3 months)
- Medium term downtime / hibernation (3 to 6 months)
- Extended downtime / decommissioning (more than 6 months)

5.8.1 Instructions for the starter battery for extended downtimes

Starter batteries

Note: Information starter battery

Self-discharge of batteries is a physical and chemical process and cannot be avoided even if the battery is disconnected



- For extended downtimes, the battery shall be disconnected from the genset.
- Charge battery regularly. Observe instructions of the battery manufacturer.

Depending on the battery type, check the acid level before charging and refill each cell up to the marking using distilled water as necessary.

Modern starter batteries are typically maintenance-free.

Deep discharge will damage the battery and can render it unusable.

Keep battery clean and dry. Clean battery poles (+ and -) and terminals regularly and coat with acid-free and acid-resistant grease. During assembly, ensure good contact of the terminal connections.

General limits for lead-acid batteries:

2.1 V / cell corresponds with full battery (charged).

1.95 V / cell corresponds with empty battery - recharge.

For a 12 V battery, the following applies:

- 11.7 V lower open-circuit voltage (battery empty), recharge battery.
- 12.6 V upper open-circuit voltage (full battery) - trickle charge full battery at 13.2 V.

For a 24 V battery, the following applies:

- 23.4 V lower open-circuit voltage (battery empty), recharge battery.
- 25.2 V upper open-circuit voltage (full battery) - trickle charge full battery at 26.4 V.

These values are based on a battery temperature of 20-25 °C. Observe the instructions from the battery manufacturer.

Fischer Panda recommends:

- Install battery circuit breaker and switch to OFF on the machine. (Cutting the battery circuit.)
- Secure the battery plus terminal close to the battery.
- Regularly check contacts for corrosion.

Note: Starter battery recommendation



5.8.2 Measures for short downtimes

Short downtime (1 to 3 months)

- Measure battery charge status based on open-circuit voltage.
- During downtimes >7 days, disconnect battery (e.g. battery main switch to position 0).
- Check the battery within 2 months and allow the engine to warm up for min. 10 min.
- Fill fuel tank to 100% (level to full).

5.8.3 Measures for medium term downtimes / hibernation

Medium term downtimes (3 to 6 months)

5.8.3.1 Courses for preservation:

- Check battery charge status and recharge regularly, roughly every 2 months, as necessary. Observe instructions of the battery manufacturer.
- Check cooling water anti-freeze level and refill as necessary.

The anti-freeze agent must not be older than 2 years. The anti-freeze content shall be between 40 % and 60 % to ensure corrosion protection of the cooling water circuit. Top off coolant if necessary.

If the cooling water is drained, e.g. after engine surface protection is applied, no water may remain inside the engine during the downtime. The control unit must be marked accordingly with a note specifying "NO COOLING WATER".

- Drain engine oil as specified. Refill engine with preservative oil to the max. level on the oil dipstick.
- Drain diesel from tank and refill with a protective mixture (90 % diesel and 10 % preservative oil) (level to full).

Crank engine without start.

- Dismount V-belt as specified, wrap and store in a dry location. Protect against UV radiation.

Cover alternator apertures.

Attention!

Cleaning fluids and preservatives must not enter the alternator. Risk of destroying the alternator.



- Clean engine as per manufacturer's instructions.

- Spray engine parts and V-belt disks with preservative.
- Clean air filter housing and spray with preservative (metal housing only).
- Close off intake and exhaust apertures (e.g. with tape or end caps).

Before recommissioning, remove preservatives and protective measures.

Attention!



5.8.3.2 Measures for removing surface protection after medium term downtimes (3 to 6 months).

- Check battery charge status and recharge if necessary. Observe instructions of the battery manufacturer.
- Check cooling water anti-freeze level and cooling water level and refill as necessary.
- Drain engine oil. Replace oil filter and engine oil as per the specification.
- Remove preservatives from the engine with petroleum spirit.
- Degrease V-belt disks and mount V-belt according to instructions. Check V-belt tension!
- If applicable, open turbocharger oil pressure line and fill clean engine oil into channel.
- Hold engine stop lever in zero delivery position and crank engine manually several times.
- Clean air filter housing with petroleum spirit, check air filter and replace if necessary.
- Remove covers from exhaust aperture and intake apertures.
- Connect battery. Close battery main switch.
- Hold stop lever on generator motor in neutral position and crank starter for approx. 10 seconds. Then, pause for 10 seconds. Repeat this procedure 2 times.
- Perform visual check of the generator similar to initial commissioning and start up generator.

5.8.4 Measures for extended downtimes / decommissioning

Downtimes (more than 6 months)

5.8.4.1 Courses for preservation:

- Check battery charge status and recharge regularly, roughly every 2 months, as necessary. Observe instructions of the battery manufacturer.
- Check cooling water anti-freeze level and refill as necessary.

The anti-freeze agent must not be older than 2 years. The anti-freeze content shall be between 40 % and 60 % to ensure corrosion protection of the cooling water circuit. Top off coolant if necessary.

If the cooling water is drained, e.g. after engine surface protection is applied, no water may remain inside the engine during the downtime. The control unit must be marked accordingly with a note specifying "NO COOLING WATER".

- Drain engine oil as specified. Refill engine with preservative oil to the max. level on the oil dipstick.
- Drain diesel from tank and refill with a protective mixture (90 % diesel and 10 % preservative oil) (level to full).

Crank engine without start.

- Dismount V-belt as specified, wrap and store in a dry location. Protect against UV radiation.
- Disconnect battery. Coat terminals with acid-free grease.

Cover alternator apertures.

Cleaning fluids and preservatives must not enter the alternator. Risk of destroying the alternator.

Attention!



- Clean engine as per manufacturer's instructions.
- Spray engine parts and V-belt disks with preservative.
- Clean air filter housing and spray with preservative (metal housing only).
- Spray preservative on intake and exhaust side of exhaust turbocharger (where applicable) and reconnect the lines.
- Remove valve cover and spray inside of valve cover, valve stems, springs, rocker, etc. with preservative oil.
- Remove injection nozzle and coat cylinder surface with preservative oil. Hold stop lever in zero delivery position and crank engine manually several times. Refit injection nozzles with new seals (at an operation hour of min. 100 hours after the last change). Observe torque values.
- Spray radiator cover and tank cover or radiator cover on expansion tank lightly with preservative oil and refit.
- Close off intake and exhaust apertures (e.g. with tape or end caps).

For storage for more than 12 months, the preservation measures shall be checked annually and supplemented as necessary.

Note:



Before recommissioning, remove preservatives and protective measures.

Attention!



5.8.4.2 Measures for removing surface protection after extended downtimes / recommissioning (over 6 months):

- Check battery charge status and recharge if necessary. Observe instructions of the battery manufacturer.
- Check cooling water anti-freeze level and cooling water level and refill as necessary.
- Drain engine oil. Replace oil filter and oil as per the specification.
- Remove preservatives from the engine with petroleum spirit.
- Degrease V-belt disks and mount V-belt according to instructions. Check V-belt tension!
- If applicable, open turbocharger oil pressure line and fill clean engine oil into channel.
- Hold engine stop lever in zero delivery position and crank engine manually several times.
- Clean air filter housing with petroleum spirit, check air filter and replace if necessary.
- Remove covers from exhaust aperture and intake apertures.
- Connect battery. Close battery main switch.
- Hold stop lever on generator motor in neutral position and crank starter for approx. 10 seconds. Then, pause for 10 seconds. Repeat this procedure 2 times.
- Perform visual check of the generator similar to initial commissioning and start up generator.

Fischer Panda recommends:

Note:

After extended downtimes, a full 150 h inspection as per the inspection list should be performed.



5.9

6. The Panda xGenerator

6.1 Type plate at the xGenerator

Fig. 6.1-1: Type plate at the xGenerator

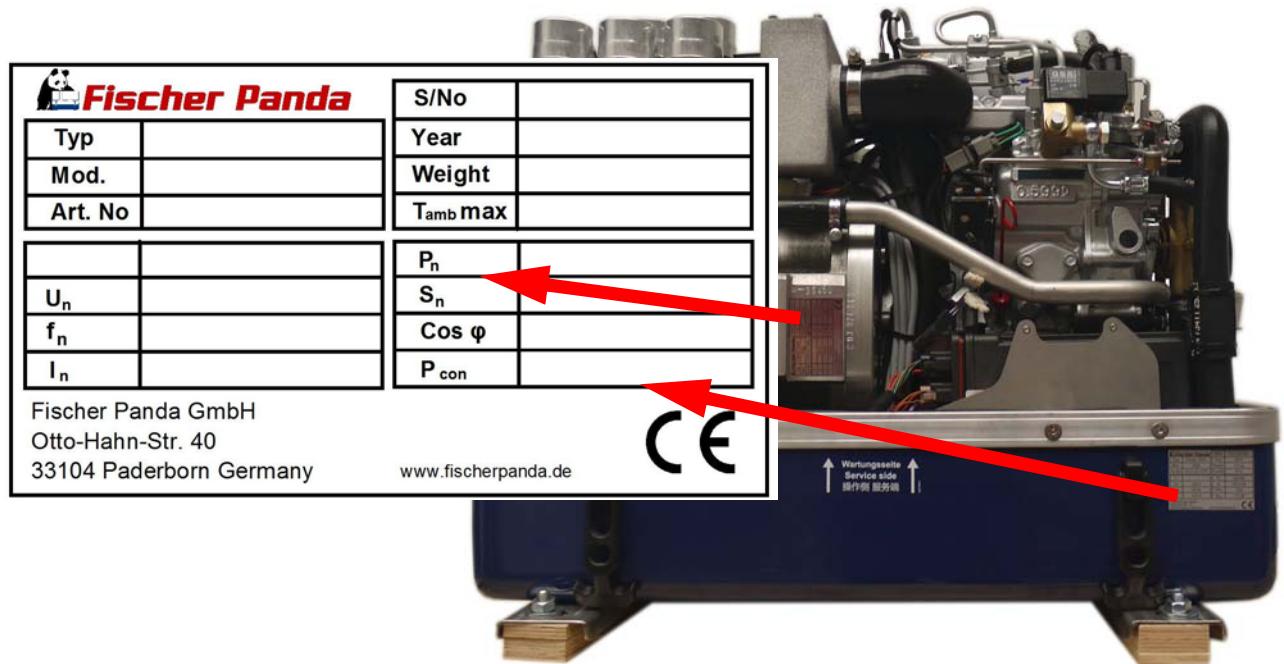




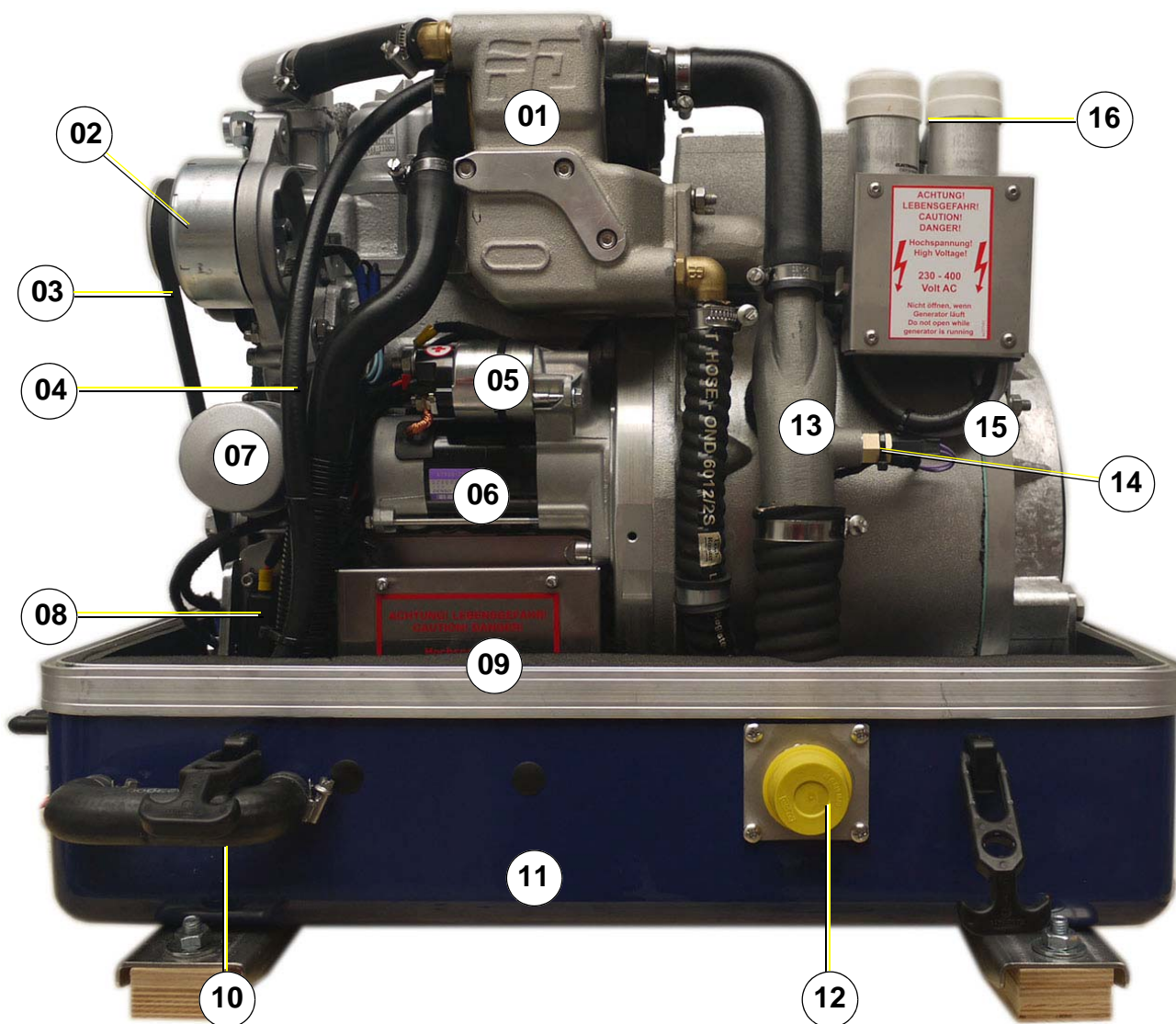
Fig. 6.1-2: Description type plate

		S/No		Serial number
Type description	Typ	Year		Year of manufacture
Model	Mod.	Weight		Weight
Articel number	Art. No	Tamb max		Ambient temperature
Interlinking		P _n		Nominal real power
Nominal voltage	U _n	S _n		Nominal apparent power
Nominal frequency	f _n	Cos φ		Nominal power factor
Nominal current	I _n	P _{con}		Electrical continuous power
Fischer Panda GmbH Otto-Hahn-Str. 40 33104 Paderborn Germany		www.fischerpanda.de		

6.2 Description of the Generator

6.2.1 Right Side View

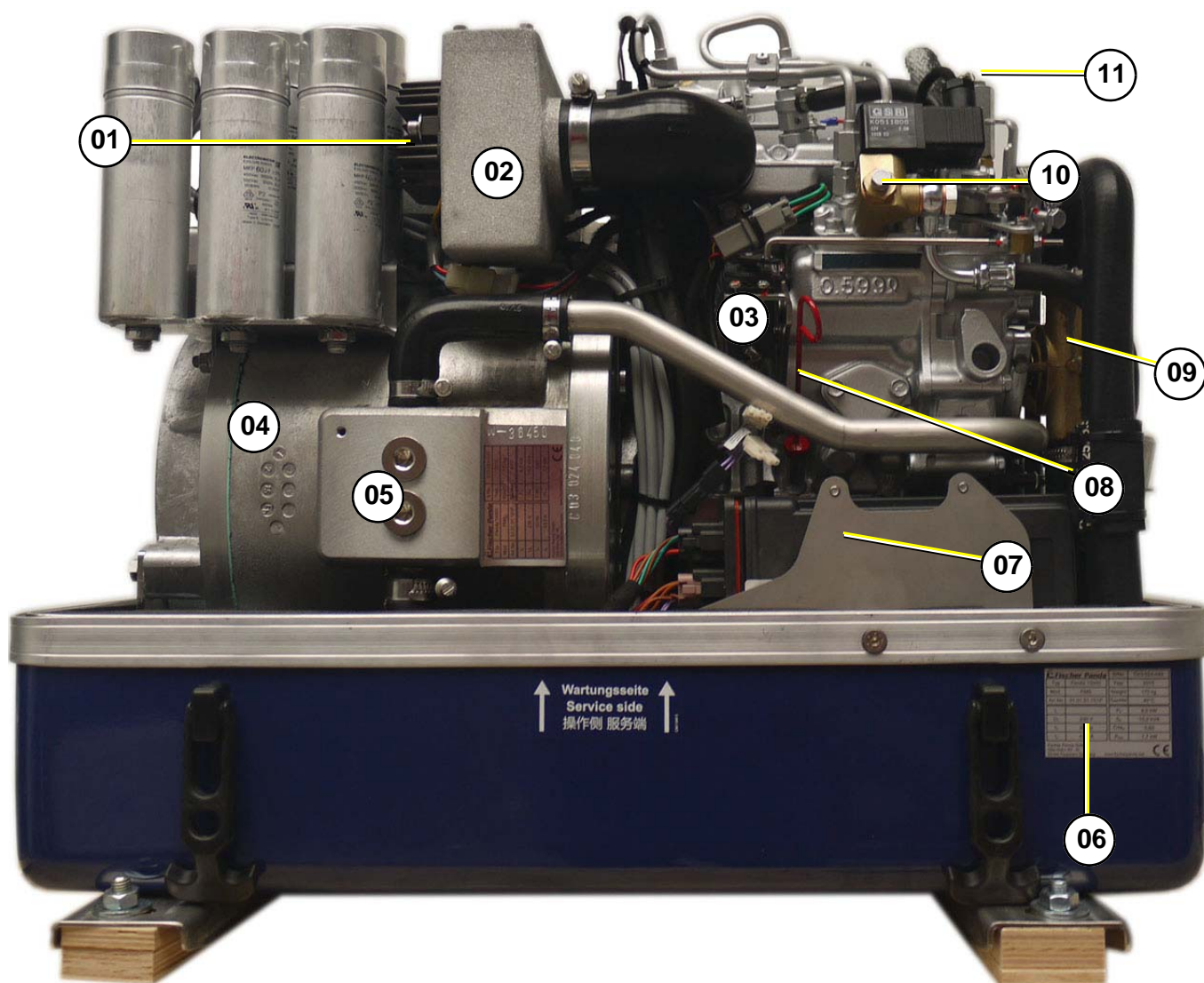
Fig. 6.2.1-1: Right Side View



- | | | | |
|------|---|-----|---|
| 01. | Water-cooled exhaust manifold / Heat exchanger (inside) | 09. | Generator power terminal box |
| 02. | DC-alternator | 10. | Connection point external ventilation valve |
| 03. | V-belt for DC-alternator and cooling water pump | 11. | Sound-cover base part |
| 04. | Oil pressure switch | 12. | Exhaust connection |
| 05. | Magnetic switch for starter motor | 13. | Raw water injection point |
| 06. | Starter Motor | 14. | Thermoswitch for cooling water injection |
| 07. | Engine oil filter | 15. | Generator housing with winding |
| 08.) | Flat fuse | 16. | Capacitors |

6.2.2 Left Side View

Fig. 6.2.2-1: Left Side View

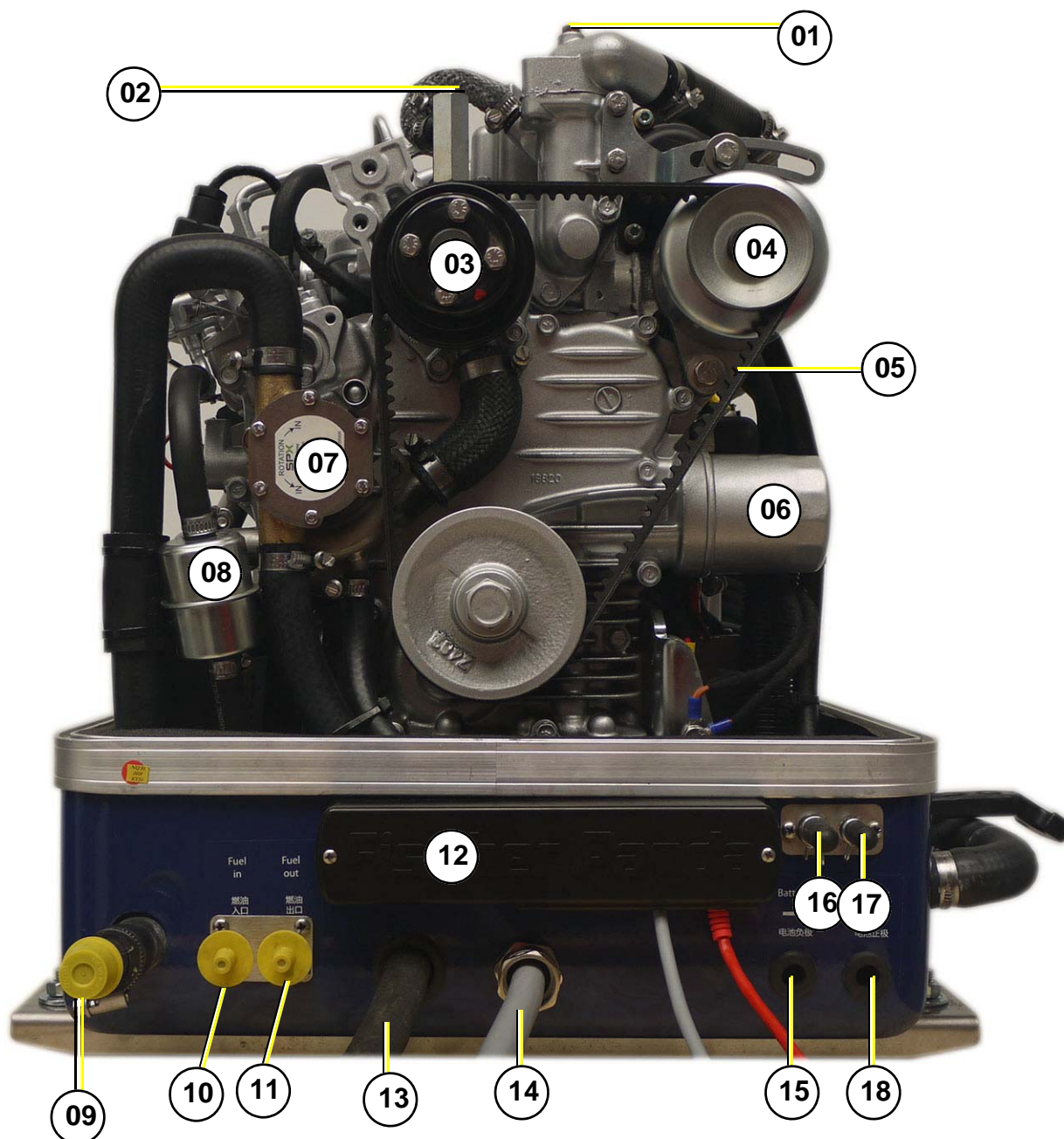


- 01) Charge control for DC-alternator
- 02) Air suction housing with air filter
- 03) Actuator for speed control
- 04) Generator housing with winding
- 05) Cooling water connection block
- 06) Sound cover base part

- 07) xControl ECU
- 08) Oil dipstick
- 09) Seawater pump
- 10) Fuel solenoid valve
- 11) Internal cooling water pump
- 12) Ventilation screw thermostat housing

6.2.3 Font View

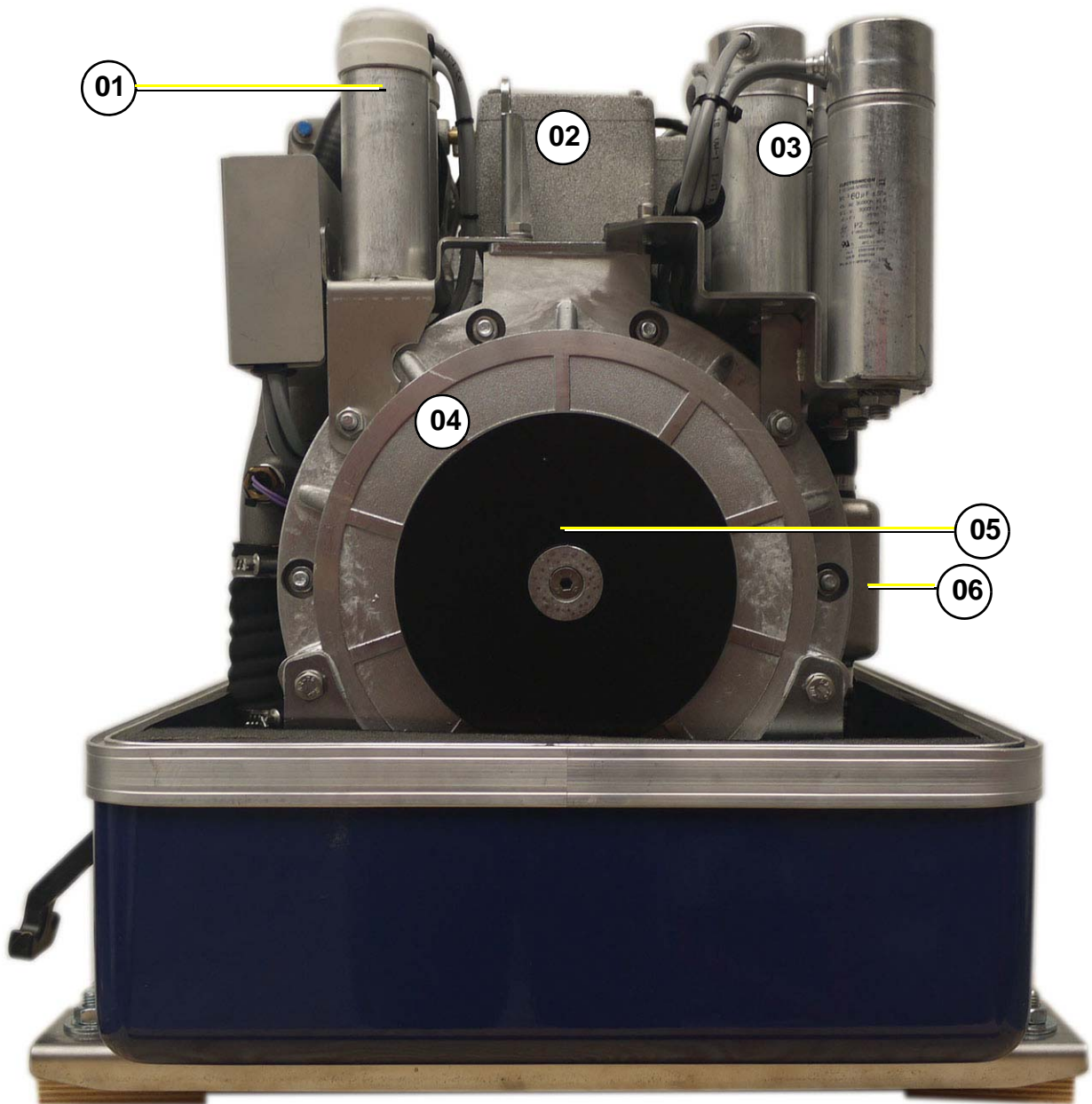
Fig. 6.2.3-1: Front View



- | | | | |
|-----|--|-----|---|
| 01) | Ventilation screw thermostat housing | 10) | Fuel intake connection (feed line) |
| 02) | Ventilation screw internal cooling water pump | 11) | Fuel backflow connection (return line) |
| 03) | Internal cooling water pump | 12) | xControl connection panel |
| 04) | Alternator 12 V | 13) | Oil drain hose |
| 05) | V-belt for DC-alternator and internal cooling water pump | 14) | Power out |
| 06) | Engine oil filter | 15) | Passage for battery cable - (negative pole) |
| 07) | Seawater pump | 16) | Intake external cooling water expansion tank |
| 08) | Fuel fine filter | 17) | Back flow external cooling water expansion tank |
| 09) | Seawater inlet | 18) | Passage for battery cable + (positive pole) |

6.2.4 Back View

Fig. 6.2.4-1: Back View

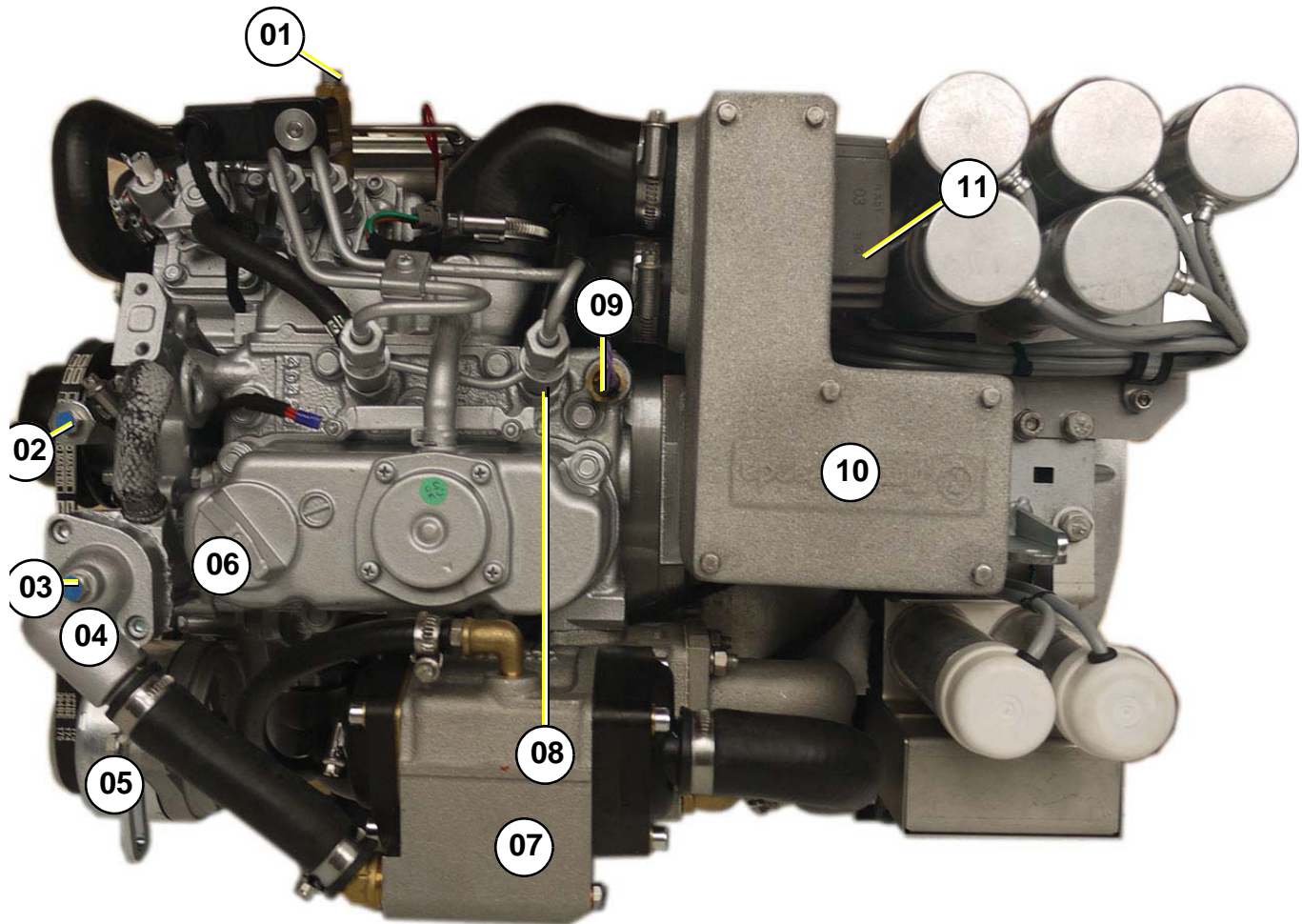


- 01. Capacitor (boost) (at generators with boost option only)
- 02) Air suction housing with air filter
- 03) Capacitor (excitation)

- 04) Generator front plate
- 05) Cooling plate
- 06) Cooling water connection block

6.2.5 View from above

Fig. 6.2.5-1: View from above



- | | |
|---|--|
| 01) Ventilation screw fuel | 07) Water cooled exhaust manifold / Heat exchange (inside) |
| 02) Ventilation screw internal cooling water pump | 08) Injection nozzle |
| 03) Ventilation screw thermostat housing | 09) Cylinder head thermosensor |
| 04) Thermostat housing with thermostat set | 10) Air suction housing with air filter |
| 05) DC-alternator/Dynamo | 11) Charge control for DC-Alternator |
| 06) Oil filler neck | |

6.3 Details of functional units

6.3.1 xControl panel

The control panel is fitted with various monitoring functions, which increase functional reliability and operating safety of the generator. Various parts of the generator are monitored with sensors which, when triggered, generate an error message and can shut down generator operation under certain circumstances to prevent damage.

Fig. 6.3-1: xControl CP-G Front Side



Fig. 6.3.1-2: xControl CP-G Reverse Sidel



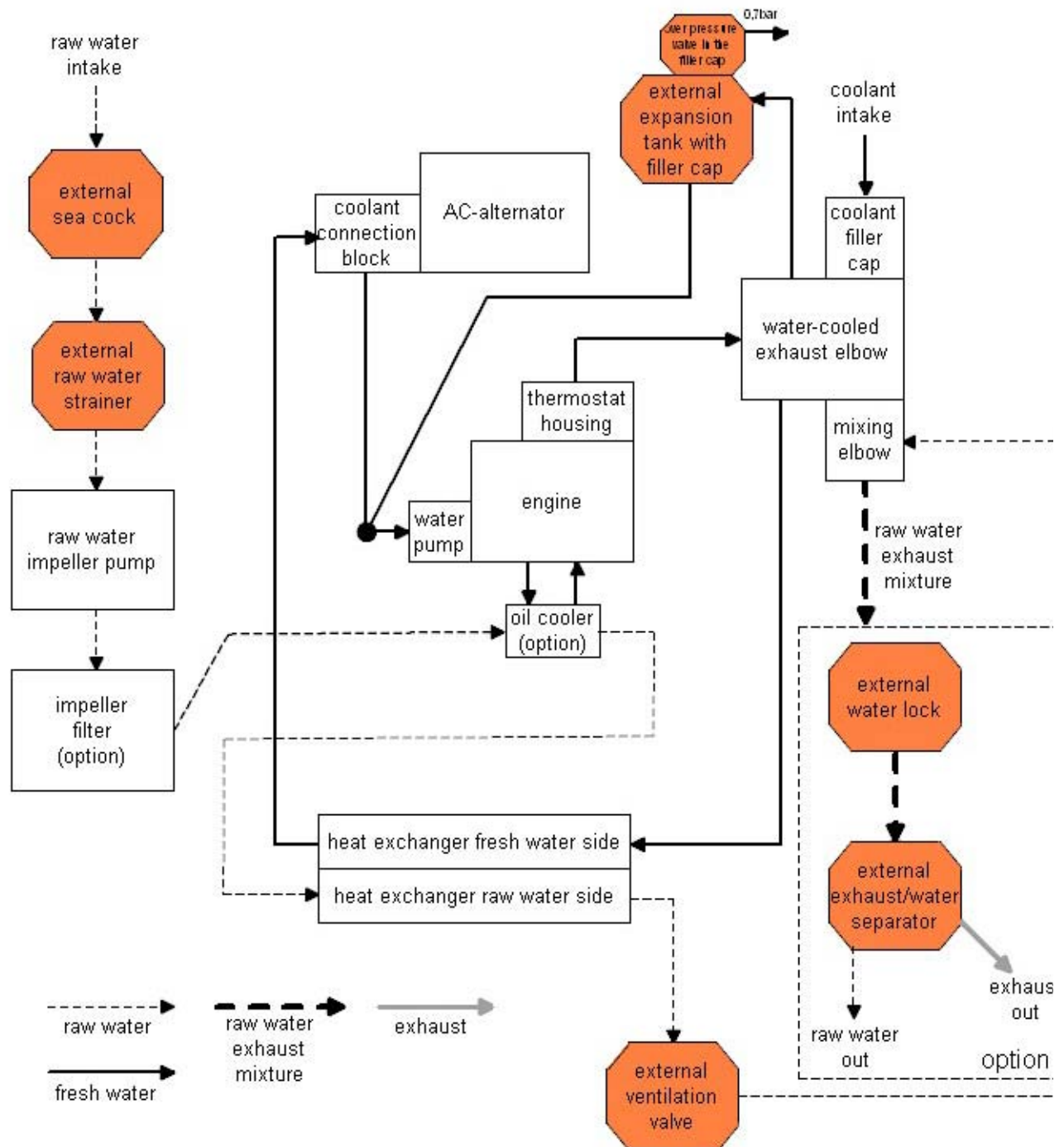
See xControl manual for details!

Notice!:



6.3.2 The Cooling System - Scheme

Fig. 6.3.2-1: The Cooling System - Scheme



6.3.3 The Fuel System - Scheme

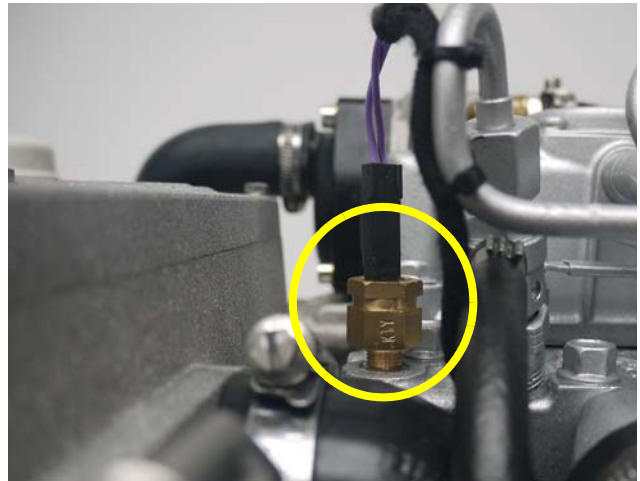
Fig. 6.3.3-1: The Fuel System - Scheme

6.3.4 The operation surveillance system

Thermo-sensor at cylinder head

The thermo-sensor at the cylinder head serves to monitor the generator temperature.

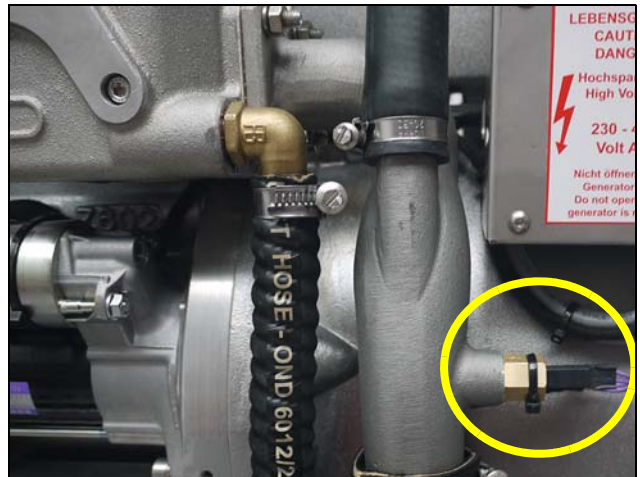
Fig. 6.3.4-1: Thermo-sensor at cylinder head



Thermo-sensor at exhaust connection

If the impeller pump stops and delivers no more raw water, the exhaust connection becomes extremely hot.

Fig. 6.3.4-2: Thermo-sensor at exhaust connection

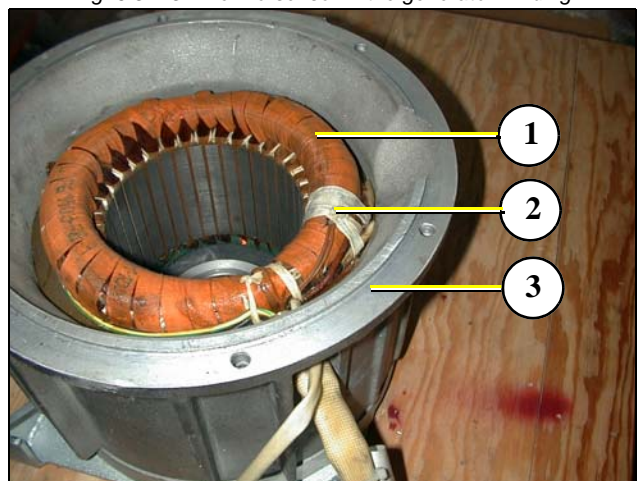


Thermo-sensor in the generator winding

1. Generator winding
2. Thermo-sensor
3. Housing

A thermo-sensor inside the windings to protect the generator winding, is installed.

Fig. 6.3.4-3: Thermo-sensor in the generator winding

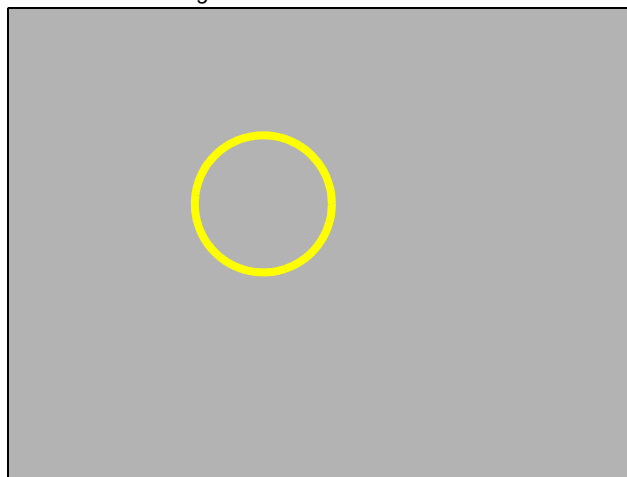


Thermo-switch at the front plate (Models with oil cooled bearing only)

The generator bearing is equipped with an oil thermo-switch, which switches the engine off, if the oil temperature becomes too high.

At generators with xControl the thermo switch is for service only

Fig. 6.3.4-4: Oil thermo-switch



Oil pressure switch

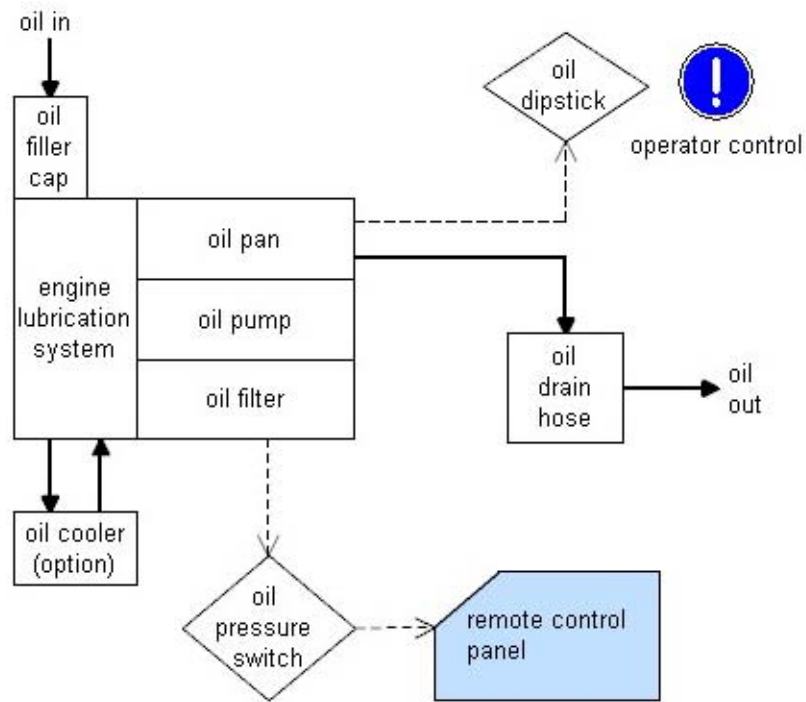
In order to be able to monitor the lubricating oil system, an oil pressure switch is built into the system. The oil pressure switch is at the rear of the engine (In front of the electrical starter).

Fig. 6.3.4-5: Oil pressure switch



6.3.5 The Oil Circuit - Scheme

Fig. 6.3.5-1: The Oil Circuit - Scheme



6.4 Remote Control Panel - see separate Control Panel Manual

6.4.1 Starting the Generator - see separate Control Panel Manual

6.4.2 Stopping the Generator - see separate Control Panel Manual

7. Installation Instructions

All connections (hoses, wires etc) and installation instructions are designed and suited for "standard" installation situations.

In situations where Fischer Panda has no detailed information concerning certain installation requirements (such as vehicle specifications, maximum vehicle speed -and all other conditions concerning special operating situations) the installation instructions should be used as an example guide only.

The installation must be undertaken and proved by a suitable qualified/trained person and may in accordance with the law as required by the country and special situation.

Damages caused by faulty or incorrect installation are not covered by the warranty.

7.1 Personal requirements

The described installation must be done by a technical trained person or a Fischer Panda service point.

7.1.1 Hazard notes for the installation

see "Safety first!" on Page 12.

Follow the general safety instruction at the front of this manual.

Working at a running generator can result in severe personal injury. Therefore before starting work at the generator:

Make sure that the generator is stopped and the starter battery is decanted to guarantee that the generator cannot be inadvertently started.

Do not run the generator with removed sound isolation cover

Improper installation can result in severe personal injuries or material damage.

- Always undertake installation work when the generator is switched off.
- Ensure there is sufficient installation clearance before start working.
- Ensure tidiness and cleanliness at the workplace. Loose components and tools lying around or on top of each other are sources of accidents.
- Only perform installation work using commercially available tools and special tools. incorrect or damaged tools can result injuries.

Oil and fuel vapours can ignite on contact with ignition sources. Therefore:

- No open flames during work on the generator.
- Do not smoke.
- Remove oil and fuel residues from the generator and floor.

Notice!:



Warning!: Risk of injury



Warning!: Risk of injury



Warning!: Danger of fire



Contact with engine oil, antifreeze and fuel can result in damage to health. Therefore:

- Avoid skin contact with engine oil, fuel and antifreeze.
- Remove oil and fuel splashes and antifreeze from the skin immediately.
- Do not inhale oil and fuel vapours.

Danger for Life. Improper handling, operation, installation and maintenance can result in severe personal injury and/or material damage.

Electrical voltages above 48 volts (battery chargers greater than 36 volts) are always dangerous to life). The rules of the respective regional authority must be adhered to. Only an electrician may carry out installation of the electrical connections for safety reasons.

Generator, oil and antifreeze can be hot during/after operation. Risk of severe burns.

During Installation/maintenance personal protective equipment is required to minimize the health hazards.

- Protective clothing
- safety boots
- protective gloves
- Ear defender
- safety glasses

Disconnect all load during the work at the generator to avoid damages at the load.

Danger!: Danger of poisoning



ATTENTION!: Danger to Life - High voltage



Warning!: Hot surface/material



Instruction!: protective equipment necessary.



Attention!: disconnect all load



7.2 Place of installation

7.2.1 Preliminary remark

- There must be sufficient fresh air supply for the combustion air.
- It has to be ensured that the cooling air supply from underneath or sidewise is sufficient.
- During operation the sea cock has to be opened.
- The generator may only be opened by a technical trained person.
- The generator may only be operated by a trained person.

7.2.2 Preparing the base - placement

Since Panda generators have extremely compact dimensions, they can be installed in tight locations. Attempts are sometimes made to install them in almost inaccessible places. Please consider that even almost maintenance-free

machinery must still remain accessible at least at the front (drive belt, water pump) and the service-side (actuator, dipstick). Please also note that in spite of the automatic oil-pressure sensor it is still essential that the oil level has to be checked regularly.

The generator should not be placed in the proximity of light walls or floors, which can have resonance vibrations because of airborne sounds. If this should be unavoidable, then it is recommended that this surface is lined with 1 mm lead foil, which will change the mass and the vibration behaviour.

You should avoid fixing the generator on a slippery surface with little mass (i.e. plywood). This acts as an amplifier of airborne sounds in the most unreasonable case. An improvement can be achieved by reinforcing these surfaces with ribs. In addition, the breakthroughs, which interrupt these surfaces, should be sawed off. The lining of the surrounding walls with a heavy layer (i.e. lead) and foam additionally improve the conditions.

As the generator sucks in its combustion air via several drill holes in the capsule base, the capsule base must be installed with sufficient space to the basement so that the air supply is guaranteed (at least 12 mm/½“)

The generator sucks its air from the surrounding engine room. Therefore it must be ensured that sufficient ventilation openings are present, so that the generator cannot overheat.

The Power out of the generator based on the following data:

Ambient temperature: 20 °C

Air pressure: 1000 mbar (100 m above normal Zero)

Raw water temperature: 20 °C

Rel. air moisture: 30 % reg. the ambient temperature

Fuel temperature: bis zu 20 °C

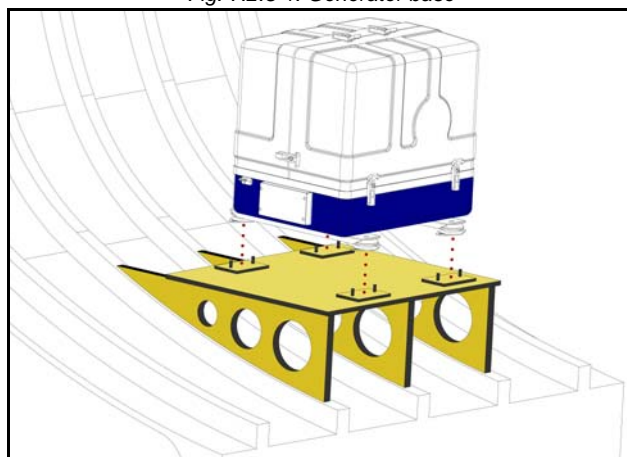
Exhaust backpressure: 80 mbar (at the exhaust out of the sound isolation cover)

Any differences to this data, for example an ambient temperature of 40 °C because of the build inside a machine room/vehicle with a bad ventilation, will cause in a lower Power out (Derating).

7.2.3 Advice for optimal sound insulation

The convenient base consists of a stable framework, on which the generator is fastened by means of shock-mounts. Since the aggregate is „free“ downwards, the combustion air can be sucked in unhindered. In addition the vibrations are void which would arise with a closed capsule base.

Fig. 7.2.3-1: Generator base



7.3 Generator Connections

Connect all electrical wires within the capsule tightly to the motor and the generator. This is also the case for fuel lines and cooling water lines.

The electrical connections MUST be carried out according to the respective valid regulations. This also concerns used cable materials. The cable supplied is meant for laying „protected“ (i.e. in pipe) at a temperature up to a max. of 70 °C (160 °F). The on-board circuit must also be fitted with all essential fuses.

Before working (installation) on the System read the section „Safety Instructions“ in this Manual.

ATTENTION!



7.4 Installation of the cooling system - raw water

7.4.1 General information

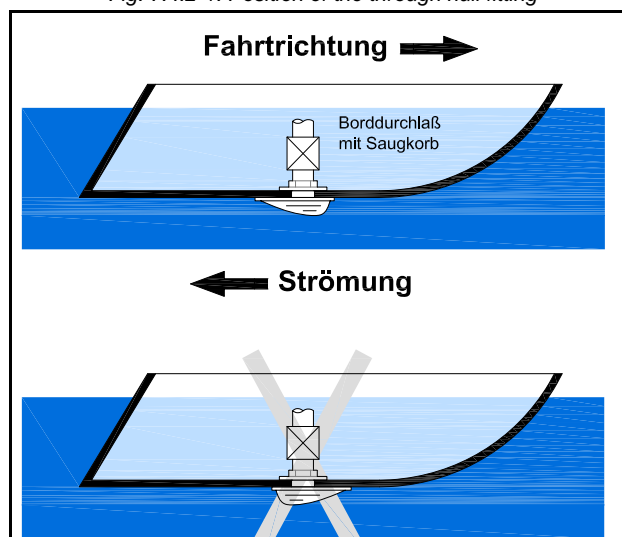
The genset should have its own raw water (coolant water) inlet and should not be connected to any other engine systems. Ensure that the following installation instructions are complied with:

7.4.2 Installation of the through hull fitting in Yachts - scheme

It is good practice for yachts to use a through hull fitting with an integrated strainer. The through hull fitting (raw water intake) is often mounted against the sailing direction to induce more water intake for cooling.

For Panda generators, the through hull inlet should NOT point in the sailing direction! When sailing at higher speeds more water will be forced into the inlet than the pump can handle and your generator will flood.

Fig. 7.4.2-1: Position of the through hull fitting



7.4.3 Quality of the raw water sucking in line

In order to keep the suction resistance in the line at a minimum, the raw water intake system must have a minimum inner diameter of the raw water intake connection. This applies also to installation components such as through-hull fitting, sea cock, raw water filter etc.

The intake suction line should be kept as short as possible. Install the raw water inlet in close proximity to the genset.

After start-up the cooling water quantity must be measured (e.g. by catching at the exhaust). For the needed flow rate see chapter tables.

7.4.4 Generator installation above waterline

The Panda is equipped with a water intake pump mounted on the motor. Since the intake pump is an impeller pump there are wearing parts which are likely to require replacement after a period of time. Ensure that the genset is installed so that the intake pump can be easily accessed. If this is not possible, an external intake pump could be installed in an easily accessible location

If the generator is installed above the waterline, it is possible that the impeller will wear out faster, because after starting, the pump runs dry for some seconds. The raw water hose should form a loop as near as possible to the raw

water inlet of the generator (see picture below). This ensures the pump only sucks in air for a short time. The impeller pump will be lubricated by raw water and the impeller life span will be increased. With the installation of a non return valve in the raw water inlet line, which is under the waterline, this problem can be restricted.

When starting the generator you should always consider when raw water runs out of the exhaust system. If this takes longer than 5 seconds you should replace the impeller pump because it sucks in air for too long before it delivers raw water. The impeller has lost its effect and cannot suck in raw water anymore. This results to an overheating of the motor. If the impeller is not exchanged early enough the impeller blades may break into pieces and plugging the cooling water cycle. It is very important to exchange the impeller after a couple of months.

If the raw water line is too long for the impeller pump or the generator installed too high above the water line a electrical pump can be installed into the raw water line. In this case the impeller should be removed out of the impeller pump.

NOTE:



Contact Fischer Panda for further information.

Never change the impeller for many years, without exchanging the old pump. If the sealing ring is defective within the pump, raw water runs into the sound cover of the genset. A repair is then very expensive.

NOTE:



Replacement impeller and also a spare pump should always be on board. The old pump can be sent back to Fischer Panda for cost-effective repair.

7.4.5 Generator installation below waterline

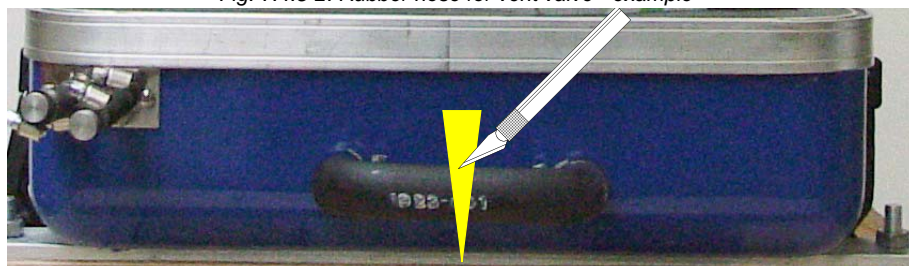
If the generator cannot be attached at least 600 mm above the waterline, a vent valve must be installed at the raw water line.

Fig. 7.4.5-1: Vent valve



Possible heeling must be taken into consideration if installed at the "mid-ship line"! The water hose for the external vent valve is located at the back of the sound insulated capsule. This hose is split in the middle and extended respectively at each end by an additional hose and a connecting nipple. Both hose ends must be led outside of the sound cover, if possible 600 mm over the waterline in the mid-ship line. The valve is connected at the highest place to the two hose ends. If the valve jams the cool water line cannot be de-aerated after stopping the generator, the water column is not discontinued and water can penetrate into the combustion chamber of the engine. This will lead to damage the engine in a short term!

Fig. 7.4.5-2: Rubber hose for vent valve - example

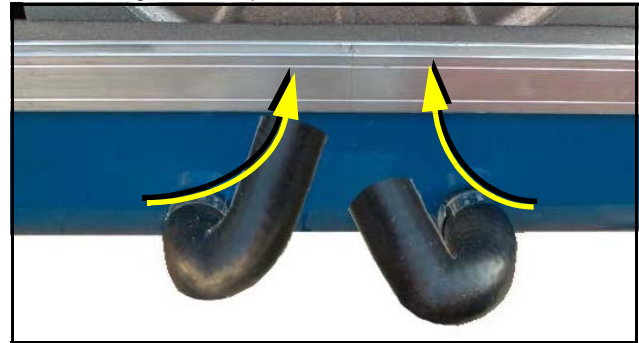


The rubber hose for the external vent valve will be cut...
 ...and bend upwards.

Both hose ends will be extended respectively with a hose and connected with a vent valve 600 mm over the waterline.

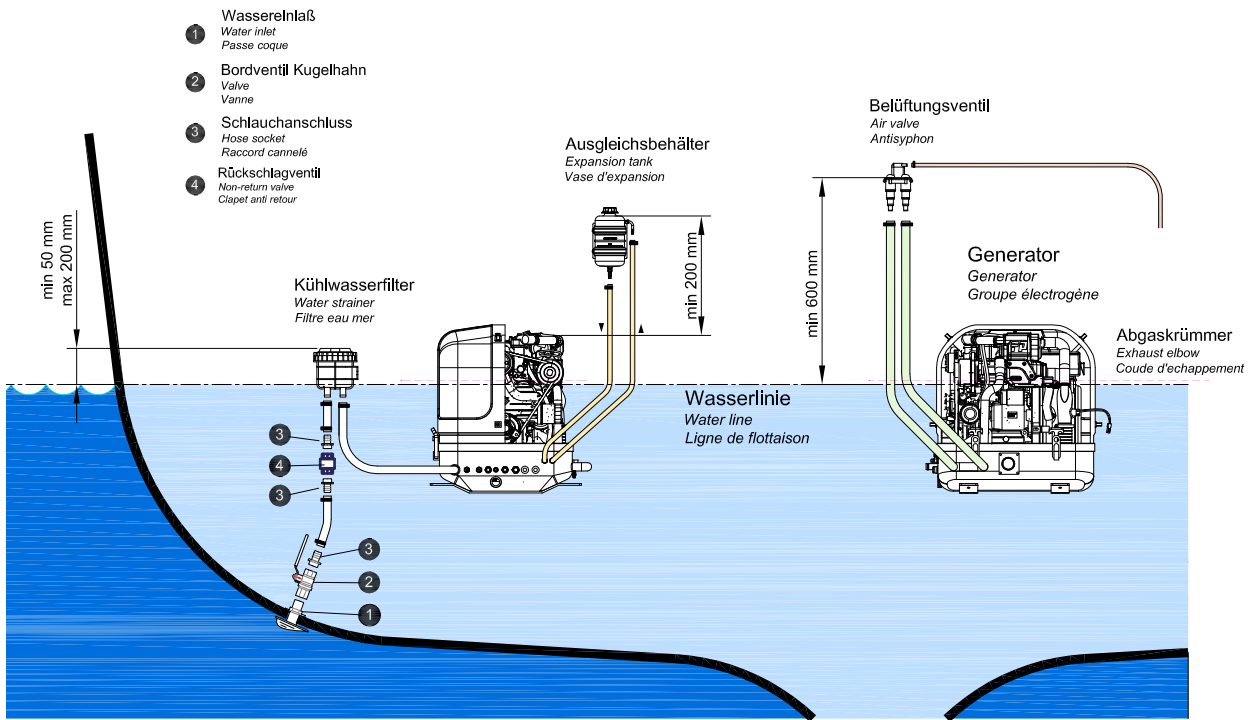
Example

Fig. 7.4.5-3: Split rubber hose for vent valve



7.4.5.1 Raw water installation scheme

Fig. 7.4.5.1-1: Raw water installation scheme



7.5 Installation of the cooling system - fresh water

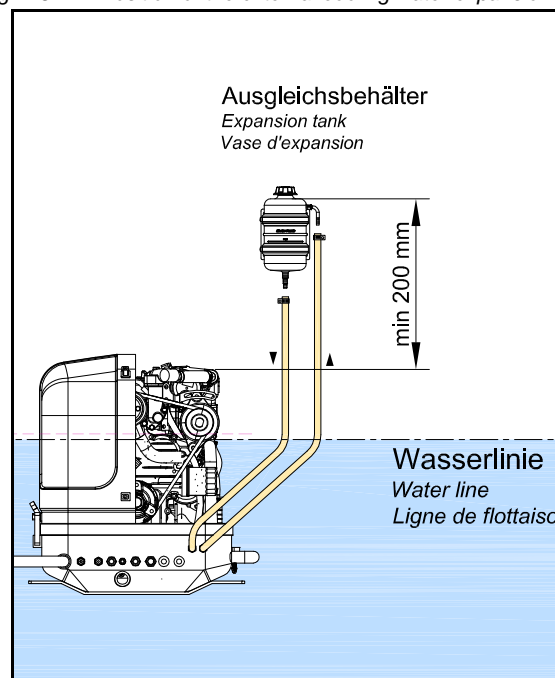
7.5.1 Position of the external cooling water expansion tank

Position of the external cooling water expansion tank

The Panda generator is normally supplied with an additional, external cooling water expansion tank. This tank must be installed in such a way that its lower edge is at least 200 mm more highly arranged than the highest point of the Generator.

If this 200 mm should be fallen below, i.e. the cooling water expansion tank is lower installed, very large problems can occur with filling and ventilating. Extend and displace the hose lines to the outside or possibly even up to the deck.

Fig. 7.5.1-1: Position of the external cooling water expansion tank



The external cooling water expansion tank may be filled only up to the lower edge of the lower tension tape (see note „max“) in the maximum filling level in cold condition.

ATTENTION!



7.6 Ventilation of the coolant circuit / freshwater

Special notes for the ventilation of the cooling system

Attention

If the cooling water is drained, or if other air has entered the cooling system, it is necessary to ventilate the cooling system.



This ventilating procedure must be repeated several times:

The generator must be switched off before opening the ventilating points!

Pay attention that the external coolant expansion tank is connected with the generator by the intended connection point.

Further it should be guaranteed that the expansion tank is attached in sufficient height (200 m) over the level of the generator highest point.

Expansion tank

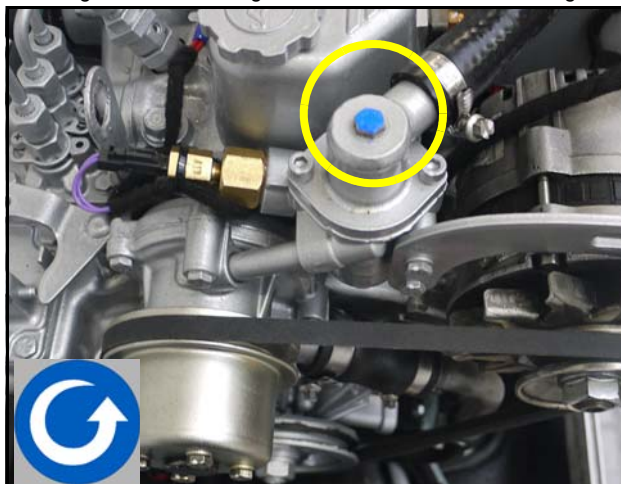
Fig. 7.6-1: Expansion tank



8. Open the ventilating screw on the thermostat housing.
Use spanner size 10 mm.

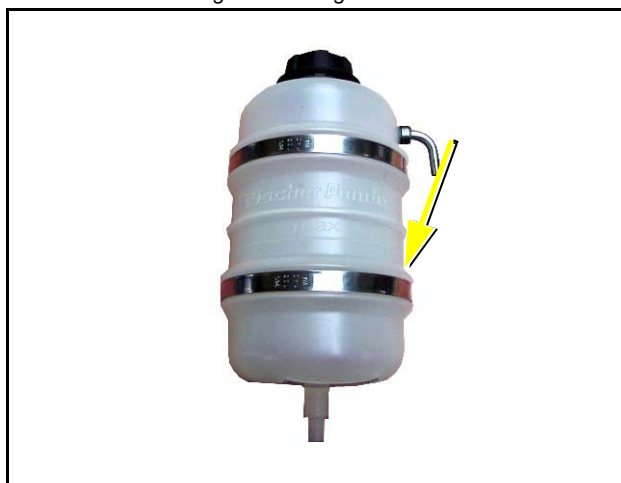


Fig. 7.6-2: Ventilating screw on the thermostat housing



9. Pour cooling water into the external expansion tank.
10. If the cooling water level no longer drops (the cooling water level in cold waters must cover the tin in the exhaust elbow), close the filler cover and the cooling water screws and then start the generator.
11. Run the generator for approx. 60 Seconds, then switch off
12. Refill cooling water via the external expansion tank.
13. The expansion tank is connected to the generator by two hoses.

Fig. 7.6-3: filling level 20%



The external expansion tank should be filled to a max 20 % in a cold state. It is very important that a larger expansion area is maintained above the cooling water level.

14. Repeat this procedure 1 - 5 times.

If there is no change to the state of the cooling water level, the generator is re-started for 5 minutes. Thereafter the de-aeration must be repeated two to three times.

Also after the first implementing a small amount of air can be reside in the cooling circuit. To ensure an immaculate and actual operating of the cooling system the ventilating process must be repeated casual in the next few days (weeks, if necessary). Small amount of air will still exit out of the ventilating openings, especially if the generator

stood still for a long time.

During the ventilating process repeated checks must be made to check the cooling water is indeed circulating. If there are air bubbles in the internal cooling water pump, it could be that the cooling water is not circulating. The generator will heat up very quickly and switch off, because of overheating.

ATTENTION!



Anti-freeze

In the interest of safety, the freezing point of the closed circuit coolant should be checked on a regular basis. Be sure that the coolant/antifreeze mixture is good for at least -15°C (5 ° F) and if it is possible that your genset experiences lower temperatures, for example during storage or transportation, then the entire cooling system should be drained and purged

7.6.1 Pressure Test for Controlling the Cooling Water Circuit

Check if a temperature difference exists between cooling water in-flow and cooling water return flow by use of the hand.

Feel the cooling water in-flow line at the internal cooling water pump.

Feel the cooling water return pipe either at the outlet of the water-cooled exhaust elbow union or at the side, where this pipe exits at the heat exchanger.

The temperature difference between in-flow and return should be approximately 10 degrees.

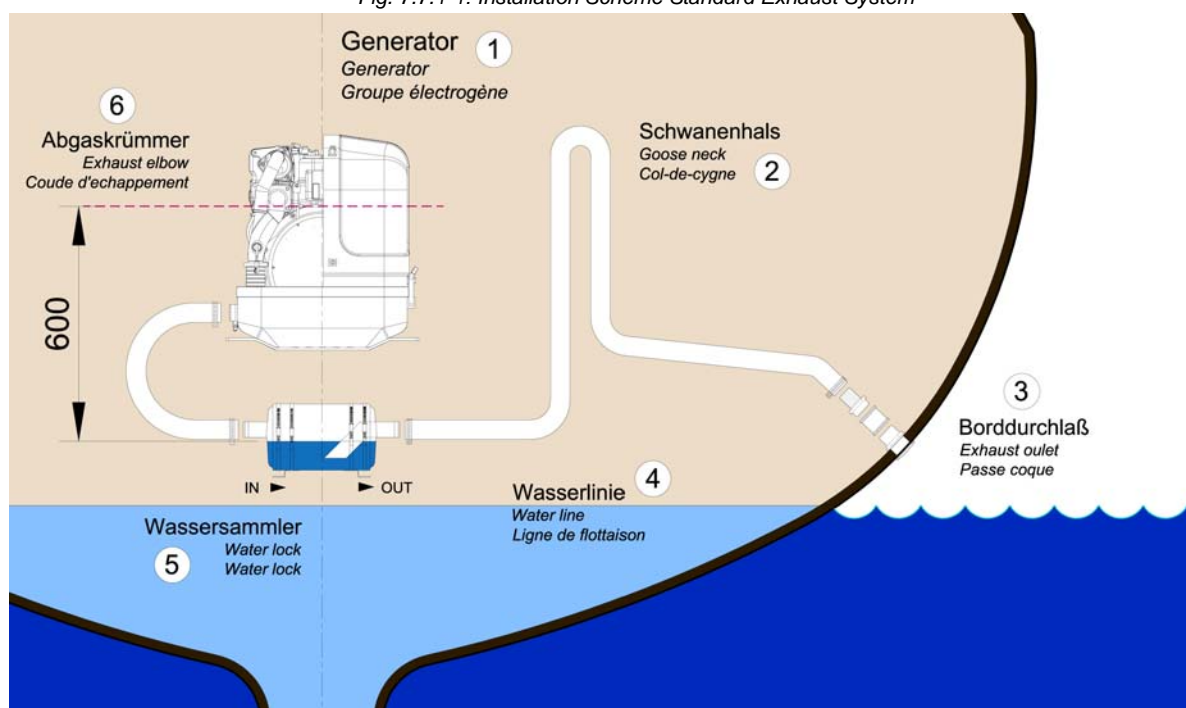
7.7 Installation of the water cooled exhaust system

7.7.1 Installation of the standard exhaust system

The generator exhaust system must remain completely independent and separate from the exhaust system of any other unit(s) on board. The water lock must be installed at the lowest point of the exhaust system. An optional noise insulated water lock can also be installed. The exhaust hose descends from the capsule to the water lock. Then the hose rises via the „goose neck“ to the silencer (see drawing). The goose neck must be vertical and sit preferably along the ship's keel centre line. In order that the back pressure inside the exhaust is not too high, the total length of the exhaust system should not exceed 6,3 m.

By injecting the outlet raw water into the exhaust manifold, the exhaust gases are cooled and the noise emissions from the exhaust system are reduced.

Fig. 7.7.1-1: Installation Scheme Standard Exhaust System



7.8 Installation of the waterlock

Pay attention to the right flow direction through the waterlock.

Note!:



Unfortunately, it can occasionally occur that, because of an disadvantageous mounting position of the waterlock, sea water gets into the diesel engines' combustion chamber. This disables the diesel engine by irreversible damages. Quite frequently, this leads to discussions during which the parties involved in the yachts' construction or the installation of the generator have to explain themselves.

One point in this situation can be clarified definitely:

If sea water gets into the inner section of the engine, this is not possible due to constructional defects of the generator or to malfunctions on the engine itself. It can only reach the combustion chamber via the exhaust hose and thus get into the engine.

Thereby, the position of the generator and the waterlock, as well as the arrangement of the cooling water and exhaust hoses play the decisive role.

If the waterlock is arranged in an unfavourable position, the cooling water flowing back in the exhaust hose can rise so high, that it reaches the exhaust stack. Since at least one discharge valve is always open when the engine is shut off, the sea water has free access to the combustion chamber. By capillary action, this sea water then flows past the cocks and even reaches the engine oil in that way. (In fact, a surprisingly high oil level is a first indication of an upcoming catastrophe).

If an usual high oil level can be detected and/or the oil is of a greyish colour, the engine must not be used anymore. This is a certain sign for cooling water that got into the oil pan. If the engine is started under these conditions, the water and the oil are mixed into an emulsion. The oil will quickly become so viscous that one will have to call it a paste. In this phase the fine oil hoses are blocked and a few moments later the machine gets destroyed because of insufficient lubrication. Before this happens, an immediate oil change should be made. Since the water can only reach the engine via the combustion chamber, it can be assumed that the compression rings will start to corrode. These effects have to be discussed with an engine expert. It will certainly be reasonable to immediately inject plenty penetrating oil through the intake stack and to slowly turn the engine with the starter motor.

The cooling water can reach the exhaust area via the exhaust hose as well as via the cooling water feed.

7.8.1 Possible cause for water in the exhaust hose

7.8.1.1 Possible cause: exhaust hose

If the cause is the exhaust hose itself, the following points are to be checked at the hose:

- a) Position of the waterlock is too high. The water reaches the exhaust hose.
- b) Position of the waterlock is too far away from the middle of the generator. The water reaches the exhaust hose in tilted position.
- c) The waterlock is too small relating to the length of the exhaust hose.

7.8.1.2 Possible cause: cooling water hose

If the generator is not clearly installed 600 mm over the water line, the cooling water feed must be equipped with a „venting valve“ which is at least led out 600 mm over the water line. (This position must also be assured in every tilted position. Therefore, the venting valve should be located in the ships' center line, so that it cannot move in tilted position).

- a) Position of the venting valve is too low. The water flows into the exhaust area when the ship is tilted.
- b) Position of the venting valve is too far from the ships' center line. The water reaches the exhaust area when the ship is tilted.
- c) The venting valve does not work, because it jams or it is clotted. (The venting valve's function needs to be checked regularly.)

As it consistently happens that functioning risks are not realised during the laying of the exhaust hose, the following explanations refer explicitly to the exhaust hose. Here, the location, the size and the position of the „waterlock“ play a very decisive role:

7.8.2 Installation area of the waterlock

Concerning a water-cooled exhaust system, it must be regarded that - under no circumstances - cooling water from the exhaust hose can get into the exhaust elbow area at the engine. If this happens, the cooling water can get into the combustion chamber via an open discharge valve. This would lead to irreparable damage at the engine.

In addition to that, one has to reckon with possible tilted positions of sailing yachts, which makes the position of the waterlock even more important. In general one could say that:

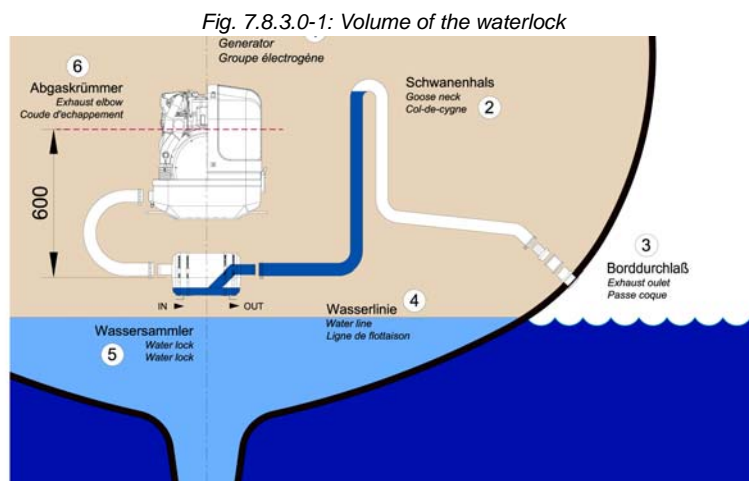
The deeper the waterlock is located underneath the generator, the better the protection from entering water into the combustion chamber.

The picture below shows that the distance between the critical point at the exhaust elbow and the maximum permissible water level in the exhaust hose is stated with 600 mm. This distance should be understood as a minimum distance.

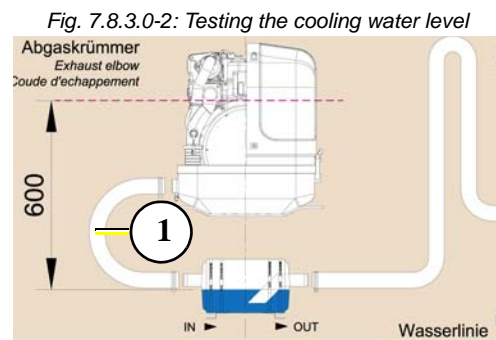
7.8.3 The volume of the waterlock

The waterlock must be measured so large, that it can take the entire amount of water flowing back from the exhaust hose. The amount of water depends on the hoses' length (L) and its cross section. While the diesel engine is running, cooling water is continuously injected into the exhaust system and is carted outside with the emissions by the exhaust gas pressure. When the engine is turned off, the number of revolutions sinks quite fast. By doing so, the point is reached where the exhaust gas pressure does not suffice anymore to cart the cooling water out. All cooling water remaining in the hose at that point flows back into the waterlock. At the same time, the diesel engine itself continues to cart cooling water through the cooling water pump, as long as it keeps on rotating.

The waterlock must necessarily be measured large enough that it can take the entire amount of cooling water and, at the same time, does not exceed the prescribed vertical height of 600 mm up to the critical point at the exhaust elbow.



If there are any doubts, a verification can easily be made by temporarily using a clear-sighted hose (1) as exhaust hose. In that way, the cooling water level can be checked very easily.



7.8.3.1 Ideal position of the waterlock

The ideal position of the waterlock would be in center underneath the generator.

Only in this position it is assured that the water level cannot change drastically in tilted position by the waterlock moving out of the center line.

See the following pictures:

Important Note!



In Fig. 7.8.3.1-1, the waterlock is mounted in center underneath the generator.

When the ship tilts, the position of the waterlock related to the critical point at the exhaust hose, changes only slightly.

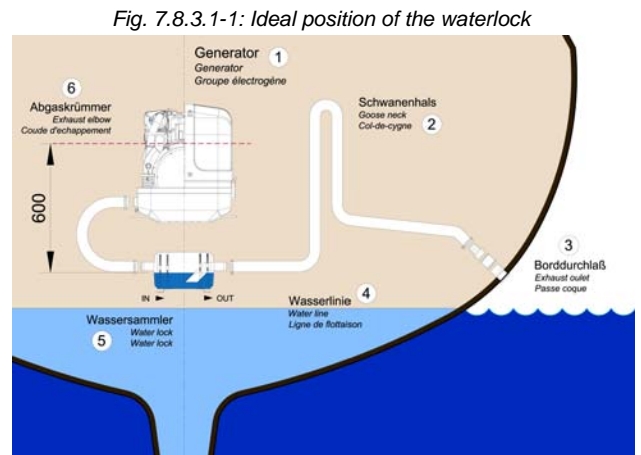


Fig. 7.8.3.1-1: Ideal position of the waterlock

Tilted position 15 degrees - Fig. 7.8.3.1-2

The distance from the exhaust elbow to the hydrostatic head has derated to 540 mm.

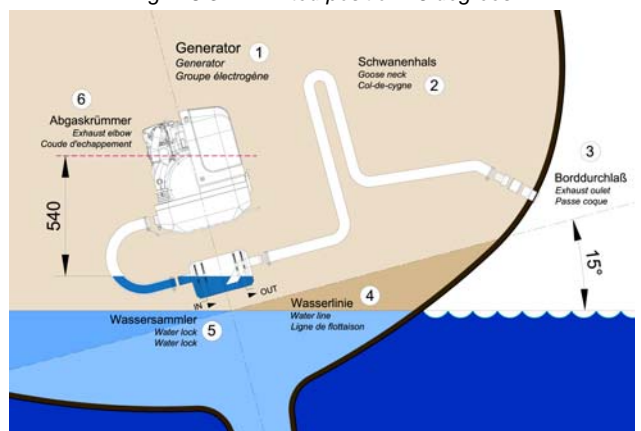


Fig. 7.8.3.1-2: Tilted position 15 degrees

Tilted position 30 degrees - Fig. 7.8.3.1-3

The distance of the water level, even in ideal position, changes that only 458 mm distance remain. So the critical distance is under-run already.

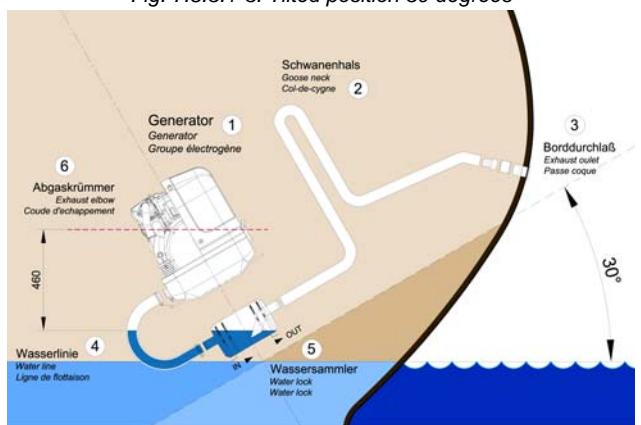


Fig. 7.8.3.1-3: Tilted position 30 degrees

Tilted position 45 degrees - Fig. 7.8.3.1-4

In this case the water level rise so high, that the distance constitutes only 325 mm.

Even when the water lock is mounted in the ideal spot, at an extremely tilted position of 45 degrees there is still the risk that water can get straight into the discharge stack area through strong rocking motions („sloshing“). This shows that the distance of 600 mm represents a minimum size at which, even when installed ideally, the water can slosh into the exhaust elbow when the ship is very tilted or rocks very hard.

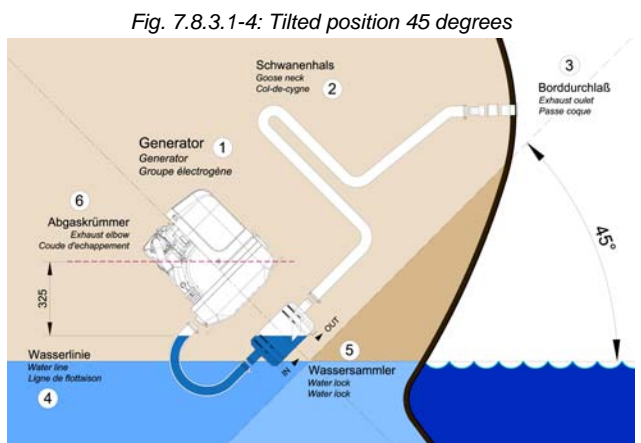


Fig. 7.8.3.1-4: Tilted position 45 degrees

Summary:

The preset minimum height of 600 mm must be regarded unconditionally and is only valid if the waterlock is mounted in its ideal position in center underneath the generator. A higher position is highly recommended if it has to be reckoned with tilted positions of 45 degrees.

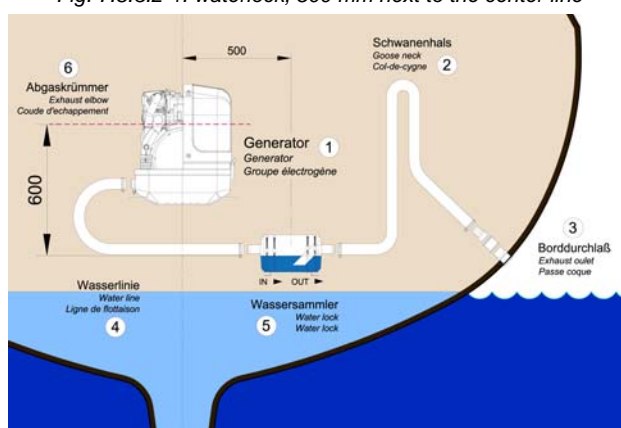
7.8.3.2 Example of the installation of the waterlock off-center and possible effects:

The following pictures are primarily relevant for an installation of the generator with the waterlock on sailing yachts. A change in the mounting position caused by tilted position does not have to be reckoned concerning motor yachts. Here it is only necessary to regard that the volume of the waterlock is measured so large that it can take the entire amount of water flowing back, and at the same time, maintains the minimum distance of 600 mm.

A) Installation of the waterlock 500 mm next to the generator's center line:

Installation of the waterlock 500 mm next to the generator's center line

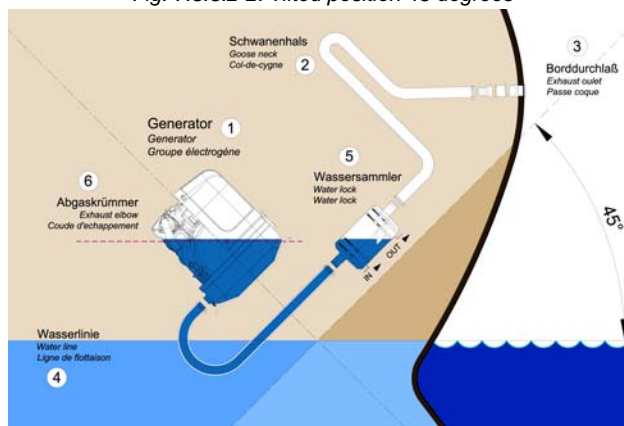
Fig. 7.8.3.2-1: waterlock, 500 mm next to the center line



Tilted position 45 degrees - Fig. 7.8.3.2-2

The water level is now at the same height as the critical point at the exhaust elbow. If the ship is sailed in a tilted position of 45 degrees with an installation like this, the ingress of cooling water into the combustion chamber is inevitable. Irreparable damages are pre-programmed.

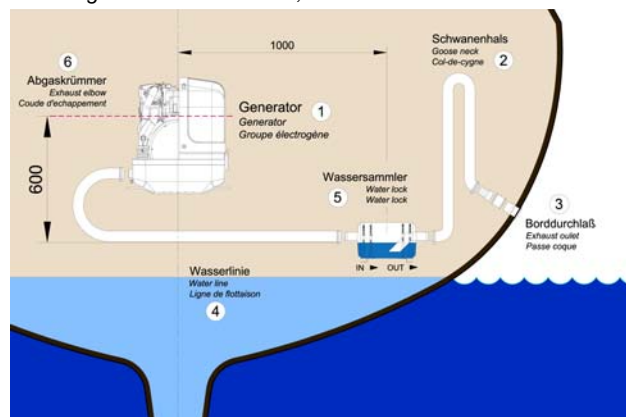
Fig. 7.8.3.2-2: Tilted position 45 degrees



B) Installation distance between waterlock and the generator's center line 1000 mm

Installation distance between waterlock and the generator's center line 1000 mm

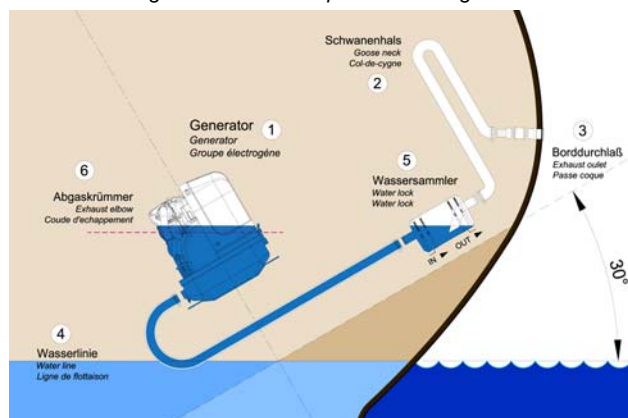
Fig. 7.8.3.2-3: waterlock, 1000 mm next to center line



Tilted position 30 degrees - Fig. 7.8.3.2-4

The water level and the critical point at the exhaust elbow are at the same level now. If the ship is sailed in a tilted position of 30 degrees with an installation like that, the infiltration of cooling water into the combustion chamber is inevitable. Irreparable damages are pre-programmed.

Fig. 7.8.3.2-4: Tilted position 30 degrees



Summary:

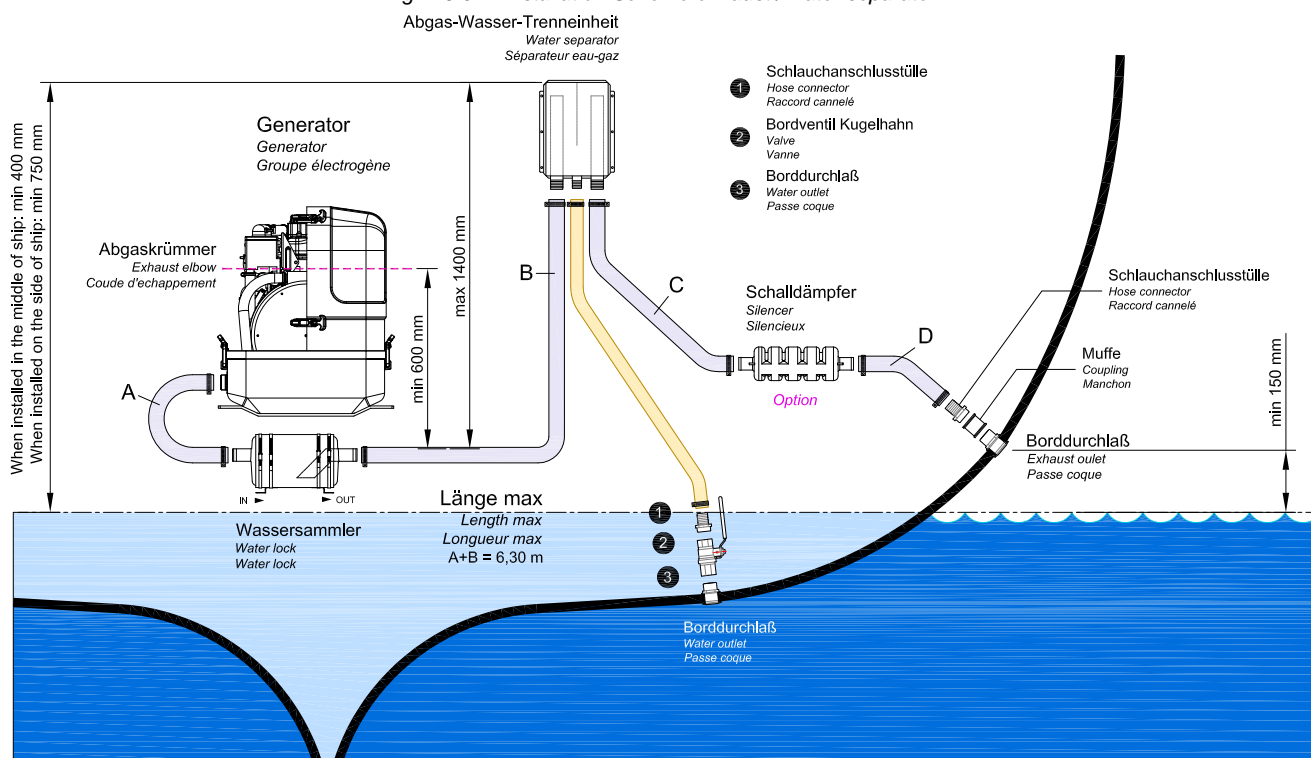
Concerning sailing yachts it must be regarded, that the waterlock is mounted in center underneath the generator, at least in reference to the ships' center line. Thus the waterlock is prevented from „leaking“ very strongly when the ship is tilted.

The „leaking“ of the waterlock leads to a rise of the water level which then gets too close to the exhaust elbow's critical point.

7.9 Exhaust / water separator

In order to reduce the noise level of the generator unit to a minimum, an optional exhaust outlet muffler can be mounted next to the through-hull fitting. Additionally there is a component at Fischer Panda, which acts as both an „exhaust goose neck“, and water separator. With this „exhaust/water separator“ the cooling water is derived over a separate pipe. The exhaust noises emanating from the exterior of the yacht are strongly decreased. Particularly the „water splash“.

Fig. 7.9.0-1: Installation Scheme exhaust / water separator

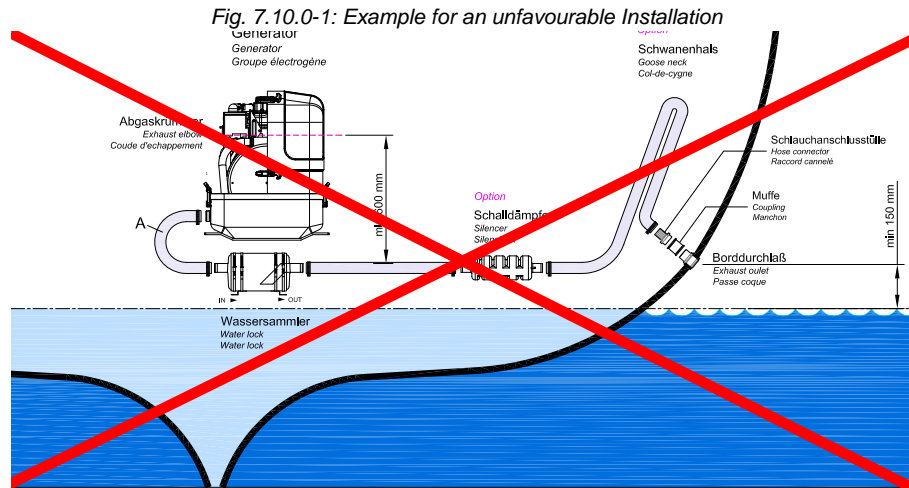


7.10 Installation exhaust water separator

If the exhaust water separator was sufficiently highly installed, a goose neck is no longer necessary. The exhaust/water separator fulfils the same function. If the „Super silent“ exhaust system were installed correctly, the generator will not disturb your boat neighbour. The exhaust noise should be nearly inaudible. The best result is reached, if the hose line, which derive the cooling water, is relocate on a short way „falling“ directly to the outlet and this outlet is under the waterline.

If the through-hull exhaust outlet has to be mounted far from the generator, an exhaust-water separator must definitely be installed. The raw water from the separator must then run along the shortest possible path in the through-hull outlet. For such long exhaust routes, the exhaust hose diameter should also be increased, f.e. from NW40mm to NW50mm in order to reduce the back-pressure. The exhaust may have a length of over 10 m (32 ft.) if the exhaust hose diameter is increased. An additional outlet exhaust muffler close to the hull outlet will help further to reduce noise emissions.

The generator will not disturb your boat neighbours, if the „Super silent exhaust system has been correctly installed. The exhaust noise should be almost inaudible.



Example of an unfavourable installation:

- Water lock not far enough below the lowest level of the generator
- Distance water lock to gooseneck too large

7.11 Fuel system installation

7.11.1 The following items need to be installed:

- Fuel supply pump (DC)
- Pre-filter with water separator (not part of the delivery)
- Fine particle fuel filter
- Non return valve
- Return fuel line to fuel tank (unpressurized)

The external Fuel pump should be installed near the tank.

Electrical fuel pump

With the Fischer Panda generator is usually supplied an external, electrical fuel pump (DC). The fuel pump must be installed close at the fuel tank. The electrical connections is prepared at the generator.

Some generators (f.e. with Deutz diesel engine) has an engine driven internal fuel pump. At these generators the electrical fuel pump is optional.

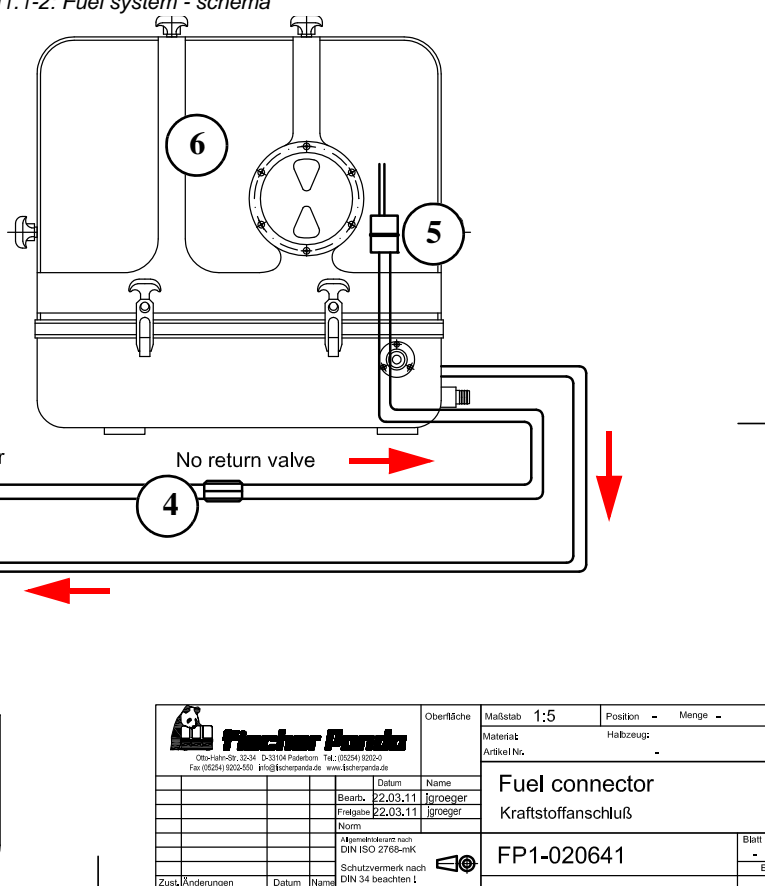
Fig. 7.11.1-1: electrical fuel pump



Fig. 7.11.1-2: Fuel system - schema

Achtung:
Kraftstoffpumpe so tief wie möglich installieren
maximale Saughöhe der Pumpe beträgt: 500mm
maximale Förderhöhe der Pumpe beträgt: 2500mm

Note:
Fuel pump installed as deep as possible
maximum suction lift of the pump is: 500mm
maximum pump head is: 2500mm



 Obi-Hall-Str. 3234 D-33104 Padborg Tel.: 05254 92020 Fax: 05254 9202550 info@fischerpanda.de www.fischerpanda.de		Oberfläche	Maßstab 1:5	Position - Menge -
		Materiale	Halbzeug:	
		Artikel Nr.		
		Fuel connector		
		Kraftstoffanschluß		
		FP1-020641		
		Blatt - BI		
Zust.	Änderungen	Datum	Name	
			Bearb. 22.03.11 jgroeger	
			Freigebe 22.03.11 jgroeger	
			Norm	
			Abnormitätsort nach DIN ISO 2768-mK	
			Schutzvermerk nach DIN 34 beachten I	

- 1. Fuel tank
- 2. external fuel pump
- 3. external fuel prefilter with water separator
- 4. Non return valve
- 5. Fuel fine filter
- 6. Generator

External fine filter

At generators with Kubota EA 300 or Farymann engines, the fine filter is delivered with the generator. This fine filter should be installed in the fuel feed line next to the generator.

representative picture

Fig. 7.11-3: externer Feinfilter



7.11.2 Connection of the fuel lines at the tank

General fuel feed and return line must be connected to the tank at separate connection points.

Note:



Connection of the return pipe to the tank

The return pipe connected to the tank must be dropped to the same depth as the suction pipe, if the generator is mounted higher than the tank, in order to prevent fuel running back into the tank after the motor has been switched off, which can lead to enormous problems, if the generator is switched off for a long period.

Non-return valve in the suction pipe

A non-return valve must be fitted to the suction pipe, which prevents the fuel flowing back after the generator has

been switched off, if it is not possible to use the return flow pipe as a submerge pipe placed in the tank. The instructions „Bleeding Air from the Fuel System“ must be read after initial operation or after it has stood still for a long period, in order to preserve the starter battery.

Non-return valve for the fuel return pipe

ATTENTION!



If the fuel tank should be installed over the level of the generator (e.g. daily tank), then a non-return valve must be installed into the fuel return pipe to guarantee that through the return pipe no fuel is led into the injection pump.

7.11.3 Position of the pre-filter with water separator

Additional to the fuel fine filter a fuel pre filter (with water separator) must be mounted outside the capsule in easily accessible places in the fuel lines between the tank intake fuel pump and the diesel motor's fuel pump.

Additionally to the standard fine filter a pre-filter with water separator must be installed outside of the sound insulation capsule in the fuel system line (not included in the delivery).

Fig. 7.11.3-1: Pre-filter with water separator



representative picture

7.12 Ventilating air from the fuel system

See chapter maintenance

7.13 Generator DC system installation

The Panda generators from 6000 upwards have their own dynamo/DC alternator to charge a DC starter battery. It is recommended to install an additional starter battery for the generator.

The generator is then independent from the remaining battery set. This enables you to start the genset at any time with its own starter battery even if the other batteries are discharged. A further advantage of a separate starter battery is that it isolates the generator's electric system from the rest of the boat's DC system, i.e. minus pole (-) is not connected electrically to Earth/Ground.

The generator is then Earth/Ground free.

7.13.1 Connection of the starter battery block

IA own separate starter battery must be installed for the generator.

The positive cable (+) of the battery is attached directly at the solenoid switch of the starter motor (position 1). The negative cable (-) of the battery is attached underneath the starter motor at the engine mount (position 2).

Panda Generators Panda 6000 and higher normally provided with an alternator/dynamo to charge the starter battery. At generators without alternator/dynamo it is

NOTE:



needed to charge the starter battery with an external battery charger.

Make sure that the voltage of the starter battery fits to the start system voltage

f.e. 12 V starter battery for a 12 V start system

f.e. 24 V starter battery for a 24 V start system (2x12 V batteries in a row)

To avoid large voltage drops the battery should be installed as near as possible to the generator. The positive terminal of the battery is attached at the red cable, the negative pole at the blue cable.

It must be guaranteed that first the cables are attached at the generator and then at the battery.

Battery connection

Wrong connection of the battery bank can cause a short-circuit and fire.

Install an appropriate fuse and a battery circuit breaker in the plus pole cable of the battery, but with a distance to the battery of up to 300 mm (12 inch) at maximum.

The cable from the battery to the safety device must be secured with protective pipe/sleeve against chafing through.

For the connection use self-extinguishing and fire-protected cables, which are appropriate for temperatures up to 90 °C, 195 °F.

The batteries must be installed in such a way that they do not chafe through or other mechanical load can be stripped.

The battery poles must be secured against unintentional short-circuit.

The positive battery cable within the generator must be shifted in such a way that it is protected against heat and vibrations by appropriate sleeve/protective pipe. It must be shifted in such a way that it does not affect rotary parts or parts, that become hot in operation, e.g. wheel, exhaust elbow union, tail pipe and the engine. Do not lay the cable too tautly, since otherwise it could be damaged.

Make a test run after the installation and check the laying of the batteries during the test run and afterwards. If necessary, correct the laying.

Examine regularly the cable laying and the electrical connections.

ATTENTION!



NOTE:



ATTENTION!: Consider correct connection sequence



ATTENTION!: Right connection of the battery.



Positive battery cable

The positive (+) battery cable is connected directly to the solenoid switch of the starter.

Fig. 7.13.1-1: Positive battery cable



Negative battery cable

The negative (-) battery cable is connected to the engine foot.

Note! The battery negative pole may not be connected with the boat ground or with the protective grounding of the DC installation!

Fig. 7.13.1-2: Negative battery cable

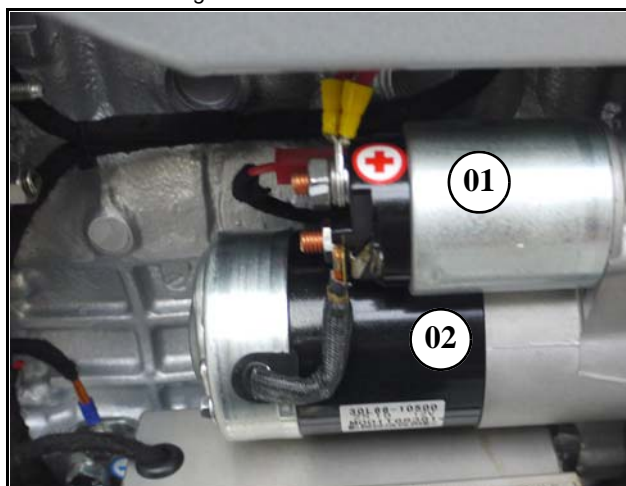


DC starter motor

All Panda generators are equipped with an independent DC starter motor.

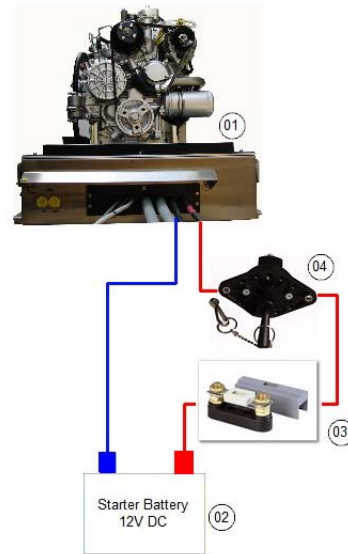
1. Solenoid switch for starter motor
2. Starter motor

Fig. 7.13.1-3: DC starter motor



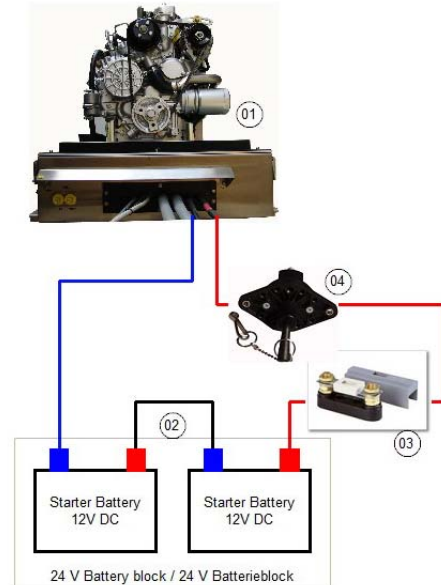
1. Generator
2. Battery block
3. Fuse
4. Battery main switch

Fig. 7.13.1-4: Connection starter battery 12 V - schema



1. Generator
2. Battery block
3. Fuse
4. Battery main switch

Fig. 7.13.1-5: Connection starter battery 24 V - schema



7.13.2 Connection of the xControl panel - see separate xControl manual

7.14 Connection Box – Generator xControl – CB-G

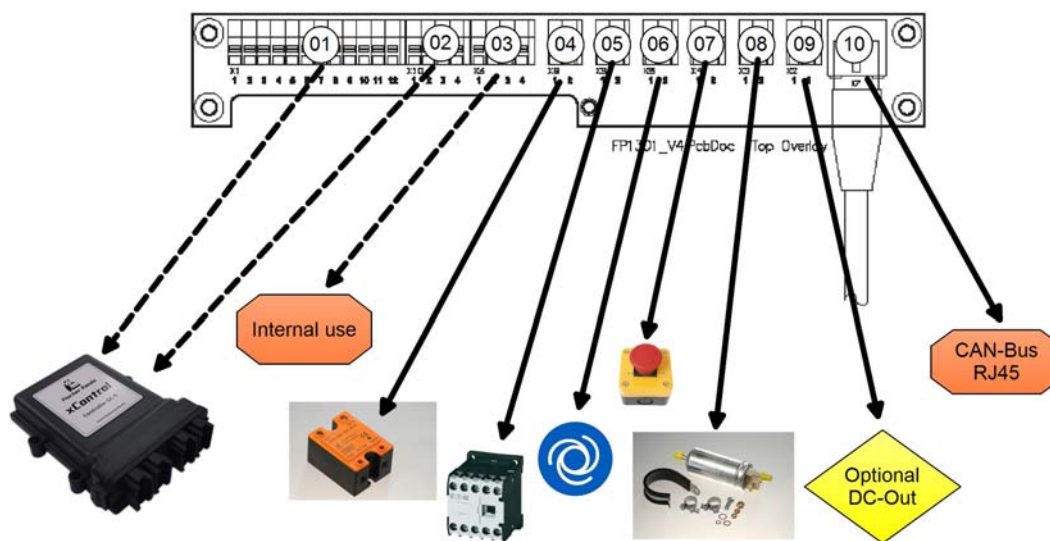
The xControl CB-G is the external interface of the generator equipped with a xControl System.

Fig. 7.14-1: CB-G

The panel and the fuel pump are connected at this interface. It is optionally possible to connect emergency stop, auto start, load contactor and boost.



Fig. 7.14-2: CB-G



- | | |
|---------------------------------|--|
| 01. Terminal xControl ECU | 06. Terminal automatic start |
| 02. Terminal xControl ECU | 07. Terminal emergency stop |
| 03. FP CAN-Bus for internal use | 08. Terminal Fuel pump |
| 04. Terminal boost relay | 09. Terminal optional DC-Out |
| 05. Terminal line relay | 10. Terminal FP CAN-Bus (external xControl components) |

7.14.1 xControl ECU

The xControl ECU is the main module of the xControl.

Installation and modification are only allowed by Fischer Panda or authorized service points.

7.14.2 FP CAN-Bus for internal use

The FP CAN-Bus terminal is for internal use only.

7.14.3 Boostrelay (optional)

The Boostrelay connect extra capacitors to the generator for a short time to compensate peak load.

7.14.4 Line Relay (optional)

The line relay protect the consumers against undervoltage and overvoltage. At standard following parameters are set:

Warning: +/- 6% generator nominal voltage.

Relay off: +/- 10% generator nominal voltage.

7.14.5 Autostart (optional)

With the autostart the generator can be started by an external signal (f.e. SPS).

7.14.6 Emergency Stop (optional)

With the emergency stop the generator will be stopped as soon as possible. All DC out will be disconnected (Line relay, fuel pump, optional DC out etc.).

If not used, the connection must be bridged.

7.14.7 Fuel pump

The fuel pump is controlled by the xControl ECU.

7.14.8 Optional DC-OUT

The optional DC out is pre configured.

At PMS generators for the external electrical water pump.

At vehicle generator for the fan control.

7.14.9 FP CAN-Bus RJ45

Connection for the external components of the xControl (Controlpanel, Paralleling Device etc.). At the end a termination resistor must be set in.

7.15 Generator AC System Installation

Before the electrical system is installed, READ the SAFETY INSTRUCTIONS of this manual FIRST!

Be sure that all electrical installations (including all safety systems) comply with all required regulations of the regional authorities. This includes lightning conductor, personal protection switch etc.

Warning!: Electrical Voltage



7.15.1 3-Phase Generator

At 3-Phase Generators (400V System) an extra 3-phase unit is installed. The 3-phase unit can be installed in the capsule, at the capsule or inside the AC-Box/cabinet.

in the 3 phase unit all datas of each phase are measured and sent to the xControl control unit. In the display the datas for each phase are shown.

Fig. 7.15.1-1: 3-Phase unit at the generator



7.15.2 Electronic voltage control xControl

The xControl controls the generator voltage and motor speed. An actuator/servo on the injection pump can increase the engine speed compared to the idle speed.

If the generator runs without load, the frequency should be approx. 48,5 - 49 Hz (50 Hz System) or 58,5 - 59 Hz (60 Hz System). The frequency (equates to the speed) can be increased by up to 8%. This ensures that the engine speed is increased when there is an extra load. The maximum speed is achieved when 80% load is reached.

The speed gauge is governed and limited by an adjusting screw, above and below. Adjustment of this screw may not occur without the expressive approval of the manufacturer.

All signals pass through the circuit board in the xControl box. The signal impulse for the Servo is passed to the electric motor.

7.15.3 Connection to the AC on-board power supply

7.15.3.1 Protective conductor

The generator is equipped with a PEN protective conductor system as standard. A Neutral and a PE line are separate on the power out cable.

If a separate protective conductor is necessary (i. e. according to national safety regulations), the bridge circuit at the generator and the AC-Control box between neutral and generator housing has to be removed. Afterwards a separate protective conductor has to be installed and connected to all the system's attached metallic housings.

It is recommended to provide a voltage indication (voltmeter) and also a power indication, if applicable, in the installation system. The voltmeter (and power indication, if applicable) has to be installed behind the selector switch so that the voltage for every possible voltage source may be indicated. A separate voltmeter for the generator itself, is therefore not required.

7.15.3.2 Electrical fuse

It is absolutely essential that the electrical system installation is inspected by a qualified electrical technician. The generator should have its own AC input electrical fuse. This fuse should be sized so that the rated current of the generator on each of the individual phases is not exceeded by more than 25%.

Data for gensets with power output greater than 30 kW on request!

The fuses must be of the slow type. A 3-way motor protection switch must be installed to protect the electrical motor.

Required fuse see section 9.2, "Rated current," on page 75.

7.15.3.3 Required cable crosssections

The following recommended electrical cable dimensions (cross sections) are the minimum required sizes for a safe installation (see section 9.3, "Cable cross section," on page 75).

7.15.3.4 Disconnecter - power source selector (three way cam switch)

A power source selector switch must be installed between the generator (or if applicable, AC-Control box) and the ship's electrical supply system. This switch must ensure that all AC consumers can be switched off at once. This switch should also be installed to keep the generator and shore (grid) power systems separate.

As disconnecter a cam switch should be used. This switch should have three positions: "Shore power" - "OFF" - "Generator". If an (DC-AC) inverter is used, a fourth position will be required.

0 Off

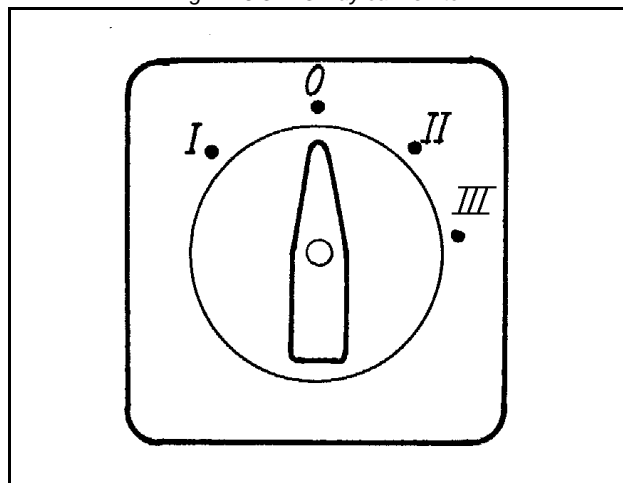
I Generator

II Shore power connection

III Inverter

Example

Fig. 7.15.3-1: 3-way cam switch



The cam-type switch must have 2 poles, so that "MP" and "phase" can be switched off.

If a 3-phase current system is also installed with the option of supplying from either the generator or shore power, an

additional switch must be installed to keep these systems separate.

An alternative to a manual rotating switch is an automatic power relay. When the generator is not running, the relay remains in the shore power position. As soon as the generator is running, the power relay switches automatically to the generator position.

It is necessary that the 3-phase AC and the single-AC have to be installed separately from each other.

7.16 Special recommendations

7.16.1 Instructions on prevention of galvanic corrosion

Galvanic corrosion

If several machines are connected by a common electrical potential (e.g. mass) and the system is also still in contact with other metal parts (e.g. the hull of a neighbour ship), always assume that the different components proceed different electrical voltage, which affect the entire system and the components. DC voltage causes an electric current, if in the environment of these parts electrically leading liquids (electrolyte) are available. This is called „galvanic process“. The electrical charge of the negatively charged fields (anode) is led to the positively charged field (cathode). The negatively charged part (anode) „is sacrificed“ thereby, i. e. that the electrical particles at the surface of the material caus decomposition with this chemical process. Since aluminium is an electrically negatively charged metal, aluminium will play the role of the anode compared with most remaining metals. This applies in particular to copper, brass, and also steel and stainless steel etc. These metals are positively charged.

7.16.2 Instructions and measures on prevention of galvanic corrosion

Several measures must be considered when making the installation so that galvanic corrosion can be avoided as much as possible:

- Separation of the water column (between raw water and generator) after shutdown. This can either be a stop vlave turned by hand (Attention! The valve must be closed after each operation) or by the installation of an automatic ventilation valve. In this case the valve opens and closes automatically.
- Connecting all components (hull outlet, generator, heat exchanger etc.) to a common potential. For this all elements of the installation are connected by a cable (earthed).
- Strict separation of the generator from the 12 V on-board power supply, that means potential free installation of the 12 V system (generator installation und general on-board power supply).

Please find more details in the information sheet „galvanic corrosion (electrolysis)“ which you can order at Fischer Panda free of charge.

7.16.3 Isolation test

After installation, before bringing into service and handover of the generator to the customer, an isolation test has to be accomplished as follows:

ATTENTION!



1. Switch off all electrical load.
2. Start the generator.
3. Measure the AC-voltage with a voltmeter (adjust to Volt/AC) between:
 - a) generator housing and AC-Control box
 - b) generator housing and ground.

The measured voltage must not exceed 50 mV (millivolt).

4. Once the safety systems have been installed, they must be checked. If a leakage current relay (RCD) has been installed, it also has to be tested in order to ensure that all contacts are connected properly. The individual phases have to be checked against each other, and between phase and ground. An additional 4th phase (L1') also needs to be checked at generators with DVS winding.
5. If the generator is protected by a ground connection, it has to be ensured that ALL electrical devices must also be connected to this „common“ ground (usually ground contacts are attached to the device's metallic housing).

The electrical system installation must also comply with the hook-up requirements of the shore current grid. Generally a leakage current relay (RCD) is sufficient for safe electrical operation; however, this must be confirmed by the electrical safety standard in the region where the system is attached to a main land power grid. The release current of the relay (RCD) has to meet the installation circumstances.

7.17 Initial operation

After successful installation an initial operation has to be performed.

For this purpose the initial operation record has to be completely filled out by the installing expert. The filled record has to be handed out to the owner.

The owner has to be instructed regarding handling, servicing and risks of the generator. This applies to the service steps and risks mentioned in the manual as well as further risks which may arise from the specific installation and the connected components.

The original initial operation record has to be sent to Fischer Panda to receive the complete guarantee. Please make a copy for your own documentation.

Note:



8. Generator operation instruction

8.1 Personal requirements

Only instructed persons are allowed to run the generator. Instructed Persons has read the manual of the generator and all ancillary components and external equipment. He must be acquaint with the specific risks and safety instructions.

Only persons who are expected to perform their tasks reliably are permitted as personnel. Persons whose reaction capability is impaired, e.g. through drugs, alcohol or medication are not permitted.

When selecting the personnel, the stipulations regarding age and occupation applying at the location must be observed.

8.2 Hazard notes for the operation

Please note the safety first instructions in front of this manual.

Notice!:



Danger for life! - The generator can be equipped with a automatic start device. This means the generator can be started by an external signal.

Warning!: Automatic start



To avoid an unexpected starting of the generator, the starter battery must be disconnected before start working at the generator.

Rotating parts inside of the generator

Attention!: Danger to life



Do not run the generator with removed sound cover. If it is necessary to test the generator without sound cover, pay special attention. Never do this work alone. Do all service, maintenance and repair with engine stopped.

Danger for Life. Improper handling, operation, installation and maintenance can result in severe personal injury and/or material damage.

Attention!: Danger to Life - High voltage



Electrical voltages above 48 volts (battery chargers greater than 36 volts) are always dangerous to life). The rules of the respective regional authority must be adhered to. Only an electrician may carry out installation of the electrical connections for safety reasons.

8.3 General operating instruction

8.3.1 Operation at low temperatures

The Generator can be started at temperatures down to - 20 °C, therefor the operation fluids like fuel, cooling water, lubricant oil ect. must be suitable for this temperatures. These should be checked before start. Cold start spray ect. are not allowed to use, or the warranty will be lost.

8.3.1.1 Pre-heating the diesel motor

Pre-chamber diesel engines are equipped with a quick glow plug. The maximum pre glow time should not exceed 20 sec. At 20 °C or more the pre glow time should be about 5-6 sec. Below 20 °C the pre glow time should be increased,

If the operation fluids have been drained and then filled with cold weather fluids, always run the generator for 10 minutes to ensure the new fuel is present throughout the system. **Note:**



8.3.1.2 Tips regarding starter battery

Fischer Panda recommends normal starter battery use. If a genset is required for extreme winter conditions, then the starter battery capacity should be doubled. It is recommended that the starter battery be regularly charged by a suitable battery-charging device (i.e., at least every 2 Months). A correctly charged starter battery is necessary for low temperatures.

8.3.2 Light load operation and engine idle

If an engine is operated on a load less than 25-30 % of its rated output, the soot of the generator will be observed which may give cause for concern. The usual results of this operation are heavier than normal lubricating oil consumption, and oil leaks from the air and exhaust manifolds. This condition is particularly evident on standby generator set applications.

8.3.2.1 The soot of the generator is due to the fact that:

The cylinder temperatures are too low to ensure complete burning of all the fuel delivered.

A further result is that of abnormal carbon build-up on the valves, piston crowns and exhaust ports. Fuel dilution of the lubricating oil will also occur.

8.3.2.2 To prevent the soot of the generator following steps should be observed:

Running on light load should be avoided or reduced to the minimum period.

In a period of 50 operation hours the engine or generator set should be run on full load for four hours, to burn off accumulations of carbon in the engine and exhaust system. This may require the use of a 'dummy load'. The load should be built up gradually from 30 % to 100 % within 3 hours and hold at 100 % for one hour.

8.3.3 Generator load for a longer period and overload

Ensure the generator is not overloaded. Overloading occurs when the electrical load is higher than the generator can provide. If this occur for a longer period, the engine may be damaged. Overloading may cause rough running, high oil and fuel consumption, increased emissions.

For a long engine life, the long term load should not exceed 80 % of the nominal load. Long term load is the load over several hours. It is harmless for the generator to deliver full nominal power for 2-3 hours.

The hole conception of the Fischer Panda generator make sure, that the full power operation at extreme condition will not increase the engine temperatures over. Please note that the emissions of the generator also increase at full power operation.

8.3.4 Protection conductor:

The standard Panda generator is grounded. The 3-phase connection (delta) centre point is bridged to earth in the AC output terminal box (mounted on the generator). This is the initial earth safety point and is sufficient to ensure safe operation however only as long as no other system is installed. This system is adapted to enable test running of the generator before delivery.

The bridge to ground (PEN) is only effective when all components in the electrical system share a common ground. The bridge to ground can be removed and reconnected to another ground system if required for other safety standards.

Full voltage connections are mounted in the electrical cabinet. It must be ensured that the electrical cabinet is secured and closed while the generator is running.

The starter battery cable should be disconnected when work is being done on either the generator or the electrical system in order to prevent accidental starting of the generator.

8.3.5 Operating control system on the Fischer Panda generator

Fischer Panda generators are equipped with various sensors/temperatures switches. The combustion engine is further equipped with a oil pressure control switch, which switches the motor off, if the oil pressure sinks to a particular level.

8.4 Instructions for capacitors - not present at all models

Danger to Life - High voltage

CAUTION!

Do not touch the capacitor contact terminals!



The generator's electrical system requires two different groups of capacitors:

- A) The booster capacitors
- B) The operating capacitors

Both types are mounted in the electrical cabinet. (At some models direct on the generator)

Capacitors store an electrical charge. It is possible that even after they have been disconnected stored energy is still held. Therefore it is essential that the connectors are not touched.

Should it be necessary to check or test the capacitors, they should be shorted out by using an insulated screw driver.

The operating capacitors are automatically discharged when the generator is stopped in the normal way. The booster capacitors will be discharged through internal resistors.

For safety however, the capacitors have to be discharged (short circuited) prior to carrying out any work on the AC-Control box.

8.5 Checks before start, starting and stopping the generator

See remote control panel data sheet/manual

The instructions and regulations of the remote control panel data sheet/manual must be respected. **Note:**

Respect the safety instruction in front of this manual.



8.6

Leere Seite / Intentionally blank

9. Maintenance Instructions

9.1 Personal requirements

All maintenance, if not special marked, can be done by the trained persons.

Further maintenance must be done by technical personal or Fischer Panda service points.

9.2 Hazard notes for the maintenance and failure

Follow the general safety instruction at the front of this manual.

Notice!



Danger for life! - The generator can be equipped with a automatic start device. This means the generator can be started by an external signal. To avoid an unexpected starting of the generator, the starter battery must be disconnected before start working at the generator.

Warning!: Automatic start



Working at a running generator can result in severe personal injury. Therefore before starting work at the generator:

Warning!: Risk of injury



Make sure that the generator is stopped and the starter battery is disconnected to guarantee that the generator cannot be inadvertently started.

Do not run the generator with removed sound isolation cover

Improper installation/maintenance can result in severe personal injuries or material damage.

Warning!: Risk of injury



- Always undertake installation/maintenance work when the generator is switched off.
- Ensure there is sufficient installation clearance before start working.
- Ensure tidiness and cleanliness at the workplace. Loose components and tools lying around or on top of each other are sources of accidents.
- Only perform installation work using commercially available tools and special tools. incorrect or damaged tools can result injuries.

Oil and fuel vapours can ignite on contact with ignition sources. Therefore:

Warning!: Danger of fire



- No open flames during work on the generator.
- Do not smoke.
- Remove oil and fuel residues from the generator and floor.

Contact with engine oil, antifreeze and fuel can result in damage to health. Therefore:

- Avoid skin contact with engine oil, fuel and antifreeze.
- Remove oil and fuel splashes and antifreeze from the skin immediately.
- Do not inhale oil and fuel vapours.

Danger for Life. Improper handling, operation, installation and maintenance can result in severe personal injury and/or material damage.

Electrical voltages above 60 volts are always dangerous to life). The rules of the respective regional authority must be adhered to. Only an electrician may carry out installation of the electrical connections for safety reasons.

Generator, oil and antifreeze can be hot during/after operation. Risk of severe burns.

During Installation/maintenance personal protective equipment is required to minimize the health hazards.

- Protective clothing
- safety boots
- protective gloves
- Ear defender
- safety glasses

Disconnect all load during the work at the generator to avoid damages at the load.

Batteries contains acid or alkalis.

Improper handling can result in battery explosion and leakage. Acid or alkalis can run out. An explosion of the battery is possible.

See the operation and safety instruction from your battery manufacturer.

Batteries contain corrosive acids and lyes.

Improper handling can cause the batteries to heat up and burst. Corrosive acid/lye may leak. Under unfavorable conditions, the battery may explode.

Observe the instructions from your battery manufacturer.

Danger!: Danger of poisoning



ATTENTION!: Danger to Life - High voltage



Warning!: Hot surface/material



Instruction!: Personal protective equipment necessary.



Attention!: disconnect all load



Warning!:



9.3 Environmental protection

Danger to the environment due to mishandling!

Significant environmental damage can occur, particularly for incorrect disposal, if environmentally hazardous operating materials are mishandled. Therefore:

- Always observe the instructions mentioned below.
- Take immediate action if environmentally hazardous materials reach the environment. Inform the responsible local authorities about the damage in the case of doubt.

The disposal must be performed by a specialist disposal company.

Environmental protection.



9.4 Maintenance interval

For the maintenance interval, please see the „General information for PMS generators“ which are attached to this manual.

At generator with dynamic operation hours (f.e. Generators with iControl2 system) the maintenance interval can may be extended.

With the dynamic operation hours the service interval can be raised up to 30 % (200 h max.). Make sure that the dynamic operation hours are not reset accidentally between the service interval.

Note:



9.5 General maintenance instructions

9.5.1 Checks before each start

- Oil level
- Leaks in the Cooling system
- Visual check for any changes, leaks in the oil drain system, v-belt, cable connections, hose clips, air filter, fuel lines

Once a month

- Grease/oil the servo motor - Trapezoid thread-spindle

Maintenance intervals - see separate data sheet

9.5.2 Check of Hoses and rubber parts in the sound insulated capsule

Check all hoses and hose connections for good condition. The rubber hoses are very sensitive to environmental influences. They wear out quickly in an environment of dry air, oil and fuel vapours, and high temperatures. The hoses must be checked regularly for elasticity. There are operating situations, when hoses must be renewed once a year.

Additionally to usual tasks of maintenance (oil level check, oil filter control etc.) further maintenance activities are to be accomplished for marine generators, such as control of the sacrificial anode (cooling water connection block) and the front seal cover at the generator.

9.6 Oil Change Intervals

The first oil change is to be accomplished after a period of operation from 35 to 50 hours. Afterwards the oil is to be changed after 150 hours. For this, the oil SAE30 for temperatures over 20°C and SAE20 for temperatures between 5°C and 20°C is to be used. At temperatures under 5°C oil of the viscosity SAE10W or 10W-30 is prescribed.

For filling quantity, see „Technical Data“ at page 107.

9.7 Checking oil-level

You require:

paper towels / cloth for the oil dipstick

The generator must be placed at level.

- with vehicular generators: Place the vehicle on a levelled surface.
- with PSC generators: Place the generator on a levelled surface.
- with marine generators: Measure the oil-level when the ship is not lop-sided.

Run the generator for about 10 minutes to ensure that the engine is warm. Wait for 3 minutes, so the oil can flow back into the oil pan.

Generator and coolant can be hot during and after operating.

Caution: Burn hazard!



Wear personal protective equipment. (Gloves, protective goggles, protective clothing and safety shoes)

- Assure generator against accidental start.
- Open the generator casing.
- Pull the oil dipstick out of the check rail.
- Clean oil dipstick.
- Put the oil dipstick back into the check rail and wait for 10 seconds.
- Pull the oil dipstick out of the check rail and read off the oil-level at the lower end of the stick.

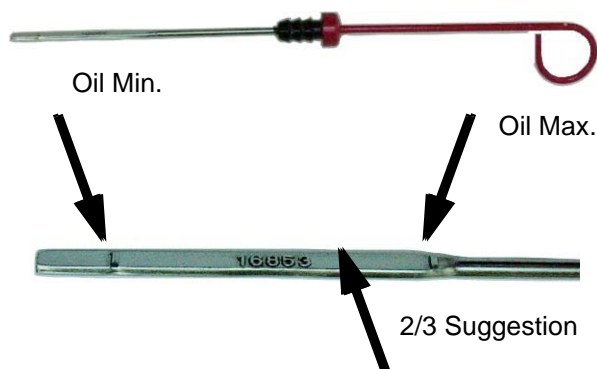
Oil dipstick

The oil-level is to be checked by means of the oil dipstick. The prescribed filling level must not cross the „Max“-mark.

We recommend an oil-level of 2/3.

Sample picture

Fig. 9.7-1: Oil dipstick - Sample



Oil dipstick EA 300 Engine

Fig. 9.7-2: Oil dipstick

The oil-level is to be checked by means of the oil dipstick. The prescribed filling level must not cross the „Max“-mark.

We recommend an oil-level of 2/3.

Sample picture



Oil should be refilled, if the oil-level is under 1/3 between the minimum and the maximum mark.

Fischer Panda recommends an oil-level of 2/3 between the minimum and the maximum mark.

If the oil-level is under the MIN-mark, check how many operating hours went by since the last oil change, by means of your service manual or an existing oil change tag. - with operating hours between 50 and 150 hours it is only necessary to refill oil. See „Refilling oil“ on page 2.

- with 150 operating hours or more the oil should be changed (See your generators' service table)
- if the oil-level is under the minimum mark by less than 50h, there might be a technical problem! In that case, we recommend going to a shop or a Fischer Panda service point.
- if the oil is cloudy or even „creamy“, coolant might have mixed with the oil. See a garage or a Fischer Panda service point immediately.

9.7.1 Refilling oil

You require:

Engine oil

1. Check oil-level as described under section 9.7, “Checking oil-level,” on page 82.
 2. Oil dipstick is pulled out of the check rail.
 3. Open the oil filler cap.
 4. Fill in oil (approx. 1/2 litre) and wait for about 2 min. so this it can flow into the oil pan.
 5. Wipe off the oil dipstick and put it into the check rail.
 6. Pull the oil dipstick out of the check rail and check the oil-level. See section 9.7, “Checking oil-level,” on page 82.
- If oil-level is still too low (under 2/3): repeat steps 4-6.

9.7.2 After the oil level check and refilling the oil

- Put the oil dipstick back into the check rail.
- Close the oil filling cap.
- Remove potential oil stains and splashes from the generator and surroundings.
- Close the generator casing.
- Remove lock against accidental generator start.

9.8 Replacement of engine oil and engine oil filter

You require:

- Engine oil. See attachment.
- New oil filter (not with generators with EA300 engines)
- Sealing for oil drain screw
- Personal protective gear
- Container to collect used oil (heat resistant and of sufficient size)
- Open-ended wrench for oil drain screw
- Paper towels and cloth
- Oil filter wrench
- Oil resistant mat, so prevent used oil from getting into underground water

The generator must be placed at level.

- with vehicular generators: Place the vehicle on a levelled surface.
- with PSC generators: Place the generator on a levelled surface.
- with marine generators: Change the oil when the ship is not lop-sided.

Run the generator for about 10 minutes to ensure that the engine is warm.

Wait for 3 minutes, so the oil can flow back into the oil pan.

Generator and coolant can be hot during and after operating.

Caution: Burn hazard!



Wear personal protective equipment. (Gloves, protective goggles, protective clothing and safety shoes)

1. Prepare generator.

- Assure generator against accidental start.
- Open the generator casing.
- with generators that have an external oil drain hose: Release the oil drain hose from the mounting.
- with generators that have an internal oil drain hose: Open the lead-through for the oil drain hose (left turn of the sealing). Pull out the sealing with the oil drain hose.

Place an oil resistant mat under the oil drain hose area and prepare the container.

2. Loosen oil filling cap

Unscrew the oil filling cap. This is necessary, because otherwise a vacuum will form and the oil can not completely drain off.

Sample picture

Fig. 9.8-1: Oil filling cap



3. Open oil drain screw.

Unscrew the oil drain screw by means of the open-ended wrench from the oil drain hose (rotating direction left). Use a second open-ended wrench to lock. Make sure to do this over the container.

Use spanner size 17 mm.



Fig. 9.8-2: Oil drain hose



4. Discharge used oil.

Let the entire amount of oil drain out of the engine. This can take several minutes.

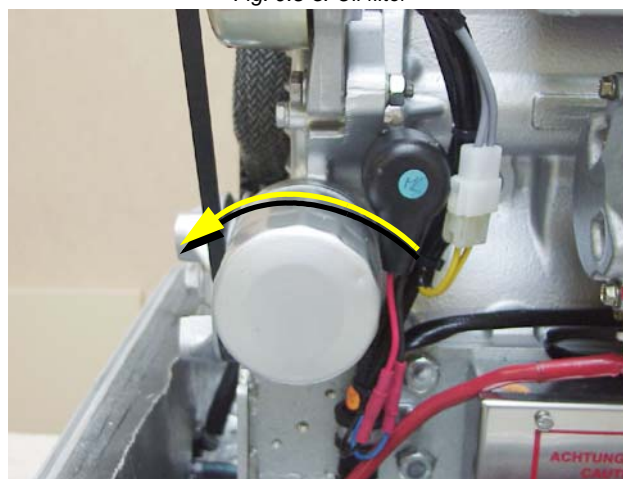
5. Remove used oil filter / clean oil screen

Release the oil filter by turning the filter wrench counterclockwise. The filter might be full of oil. Make sure to not spill anything and avoid skin contact.

Sample picture



Fig. 9.8-3: Oil filter



Oil screen with generators with EA300 engines

The oil screen should be cleaned every 500 operating hours: to do so follow the instructions in the engine manual.

Use spanner size 17 mm.



Sample picture

Fig. 9.8-4: Oil screen



6. Preparing a new filter

Clean the engines' filter holder brush a thin oil layer on the sealing of the new filter.

Fig. 9.8-5: Oil screen sealing ring



7. Mounting the new filter

Carefully screw in the new filter by hand. It must not be tightened too much. Screw in the oil drain screw again and tighten it with the wrench. Use a new sealing for the oil drain screw.

8. Fill in oil. (oil fill capacity: see attachment)

Fill the engine oil into the engine via feed hopper. Check oil-level after every 2 litres with the oil dipstick.

9. Check proper filling level. See section 9.7, "Checking oil-level," on page 82.

When the proper filling level is reached, screw in the oil cap again. Run the engine for 10 minutes and then turn it off. Check the oil-level once more after several minutes with the oil dipstick. If it is too low, refill some oil.

10. Clean up

Wipe off all oil splashes from the generator and make sure that the drain screw has no leak.

9.8.1 After the oil change

- Put the oil dipstick back into the check rail.
- Close the oil filling cap.
- Remove potential oil stains and splashes from the generator and surroundings.
- Close the generator casing.
- Remove lock against accidental generator start.
- Duly dispose of used oil and filter.

Used oil is very toxic and must not be disposed with domestic waste. It is prohibited to dispose used oil with waste water! Make sure that used oil is disposed properly (e.g.: where oil is bought or at collection stations).

9.9 Verifying the starter battery and (if necessary) the battery bank

Check the condition of the battery. Proceed here as prescribed by the battery manufacturer.

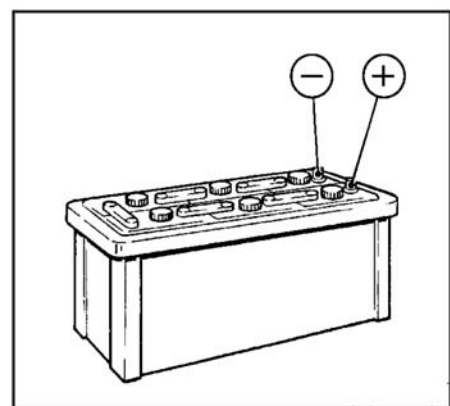
If from the battery manufacturer not otherwise mentioned.

9.9.1 Battery

9.9.1.1 Check battery and cable connections

- Keep battery clean and dry.
- Remove dirty clamps.
- Clean terminal posts (+ and -) and clamps of the battery, and grease with acid-free and acid-resistant grease.
- When reassembling, ensure that clamps make good contact. Tighten clamp bolts hand-tight.

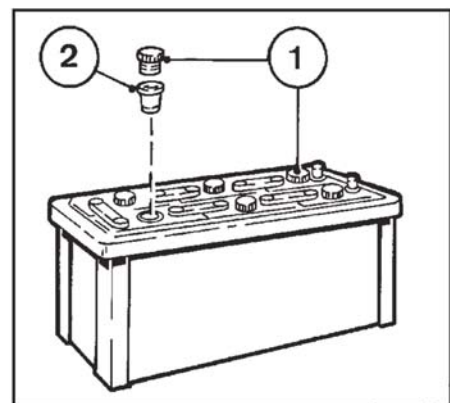
Fig. 9.9.1.1-1: Battery



9.9.1.2 Check electrolyte level

- Remove sealing caps 1.
- If testers 2 are present:
- Electrolyte level should reach the base of these.
- Without testers:
The electrolyte level should be 10-15 mm above the top of the plates.
- If necessary, top up with distilled water.
- Screw sealing caps back in.

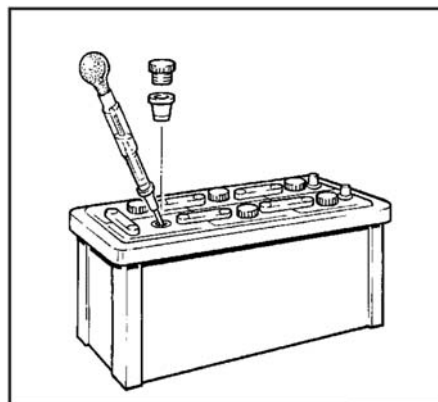
Fig. 9.9.1.2-1: Battery



9.9.1.3 Check electrolyte density

- Measure the electrolyte density of individual cells with a commercial hydrometer. The hydrometer reading (see table on following page) indicates the battery's state of charge. During measurement, the temperature of the electrolyte should preferably be 20 °C.

Fig. 9.9.1.3-1: Battery



Electrolyte density		
in [kg/ l]		Charge status
Normal	Tropical	
1.28	1.23	well charged
1.20	1.12	semi-charged, re-charge
1.12	1.08	discharged, immediately charge

The gases emitted by the battery are explosive! Keep sparks and naked flames away from the battery!

Attention



Do not allow battery acid to come into contact with skin or clothing!

Wear protective goggles!

Do not rest tools on the battery!

9.10 Checking the water separator in the fuel supply

The pre-filter with water separator has a cock underneath, by which means the water can be drained.

This water sinks to the bottom, due to the difference in the densities of water and fuel. Water is heavier than the diesel

Sample picture

Fig. 9.10-1: Pre-filter with water separator



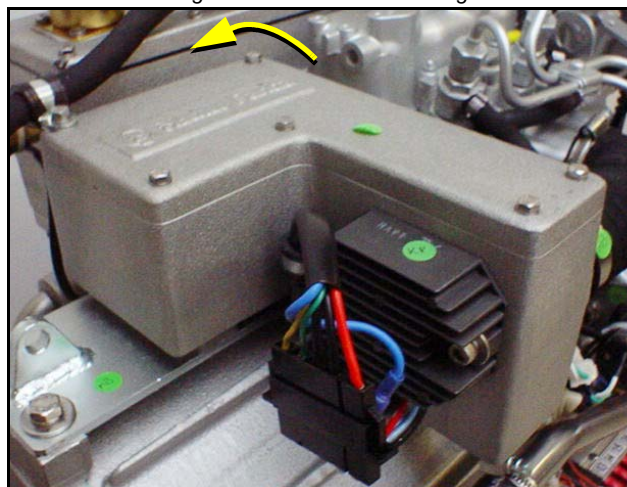
9.10.1 Replace the air filter mat

1. Open the air suction housing by loosen the six screws on the housing cover.

Use spanner size 8 mm.



Fig. 9.10-1: Air suction housing



2. Change the air filter mat.
3. Close the suction air housing.

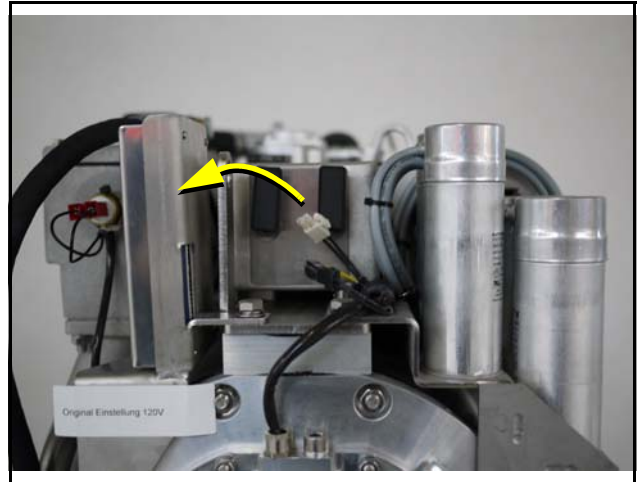
Fig. 9.10-2: Opened air suction housing



9.10.2 Alternative replacement of the air filter mat with pull out holder

1. Air filter housing with pull out holder.

Fig. 9.10.2-1: Air suction housing with pull out holder



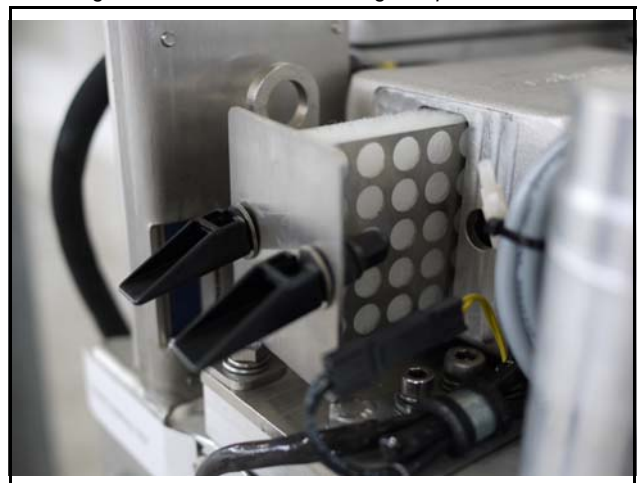
2. Tip the two fasteners 90°.

Fig. 9.10.2-2: Air suction housing with pull out holder



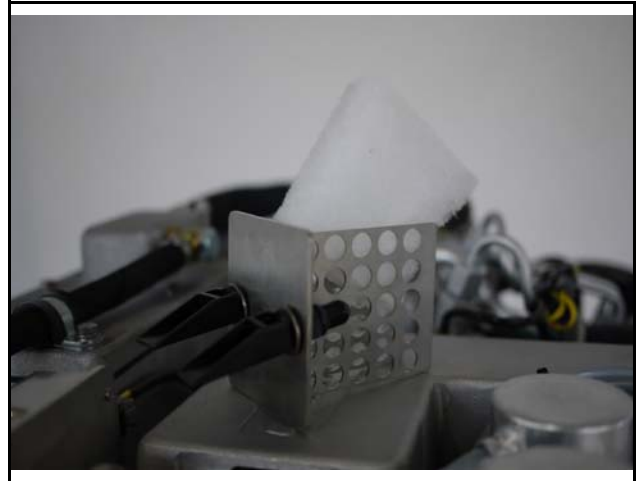
3. Pull the filter mat holder out.

Fig. 9.10.2-3: Air suction housing with pull out holder



4. Replace the air filter mat.
5. Re-assembly in reversed order.

Fig. 9.10.2-4: Air suction housing with pull out holder

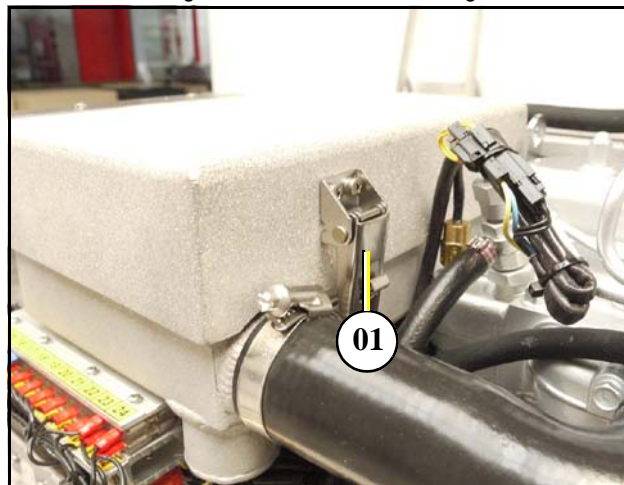


9.10.3 Alternative replacement of the air filter at housing with snap fasteners

1. Open the combustion air housing by loosening the closure on the right side of the housing.

01. Closure

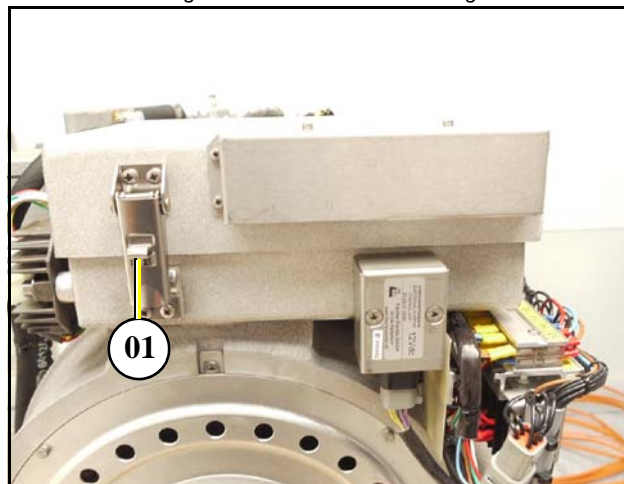
Fig. 9.10.3-1: Air suction housing



2. Open the combustion air housing by loosening the closure on the left side of the housing.

01. Closure

Fig. 9.10.3-2: Air suction housing

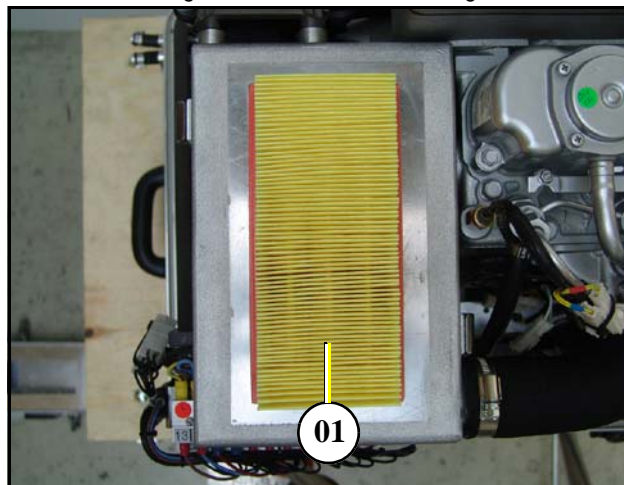


3. Open the air housing by pulling the cover.
4. Lift out the air filter element of the cover of the air filter housing.

01. Air filter

5. Replace cover in reverse procedure.

Fig. 9.10.3-3: Air suction housing



Sample picture

9.10.4 Ventilation of the coolant circuit / freshwater

Special notes for the ventilation of the cooling system

If the cooling water is drained, or if other air has entered the cooling system, it is necessary to ventilate the cooling system.

This ventilating procedure must be repeated several times:

The generator must be switched off before opening the ventilating points!

Pay attention that the external coolant expansion tank is connected with the generator by the intended connection point.

Further it should be guaranteed that the expansion tank is attached in sufficient height (200 m) over the level of the generator highest point.

Expansion tank

Attention



Fig. 9.10-1: Expansion tank



1. Open the ventilating screw above the cooling water pump casing. Not present at all models

Use spanner size 10 mm.



Not present at all models

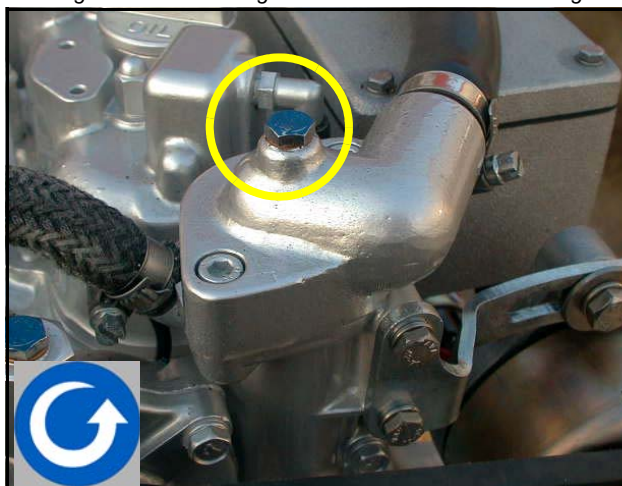
Fig. 9.10-2: Ventilating screw



- Open the ventilating screw on the thermostat casing.
Use spanner size 10 mm.



Fig. 9.10-3: Ventilating screw on the thermostat housing



- Pour cooling water into the cooling water filling necks.
(At generators without filler, The cooling water can be filled into the external expansion tank instead)
- If the cooling water level no longer drops (the cooling water level in cold waters must cover the tin in the exhaust elbow), close the filler cover and the cooling water screws and then start the generator.
- Run the generator for approx. 60 Seconds, then switch off
- Refill cooling water via the compensation tank.
- The compensation tank is connected to the generator by two hoses.

Fig. 9.10-4: Cooling water filler cap



The external compensation tank should be filled to a max 20 % in a cold state. It is very important that a larger expansion area is maintained above the cooling water level.

- Repeat this procedure 1 - 5 times.

If there is no change to the state of the cooling water level, the generator is re-started for 5 minutes. Thereafter the de-aeration must be repeated two to three times.

The ventilation screw above the cooling water pump casing may not be opened under any circumstances, whilst the generator is running. Air will be sucked through the opening, if this should happen by mistake. Venting the whole system afterwards is necessary and very difficult.



Fig. 9.10-5: Ventilation screw above the cooling water pump casing



9.10.5 V-belt replacement for the internal cooling water pump

The V-belt wears in a short time due to high ambient temperature within the closed capsule (approx. 85 °C). The air in the generator capsule is not only warm but also very dry. Therefore it is possible, that the „softener“ in the rubber compositers wear after a very short time of operation.

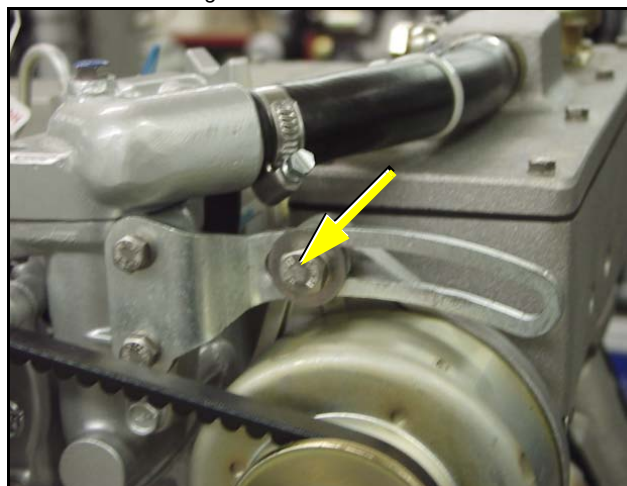
Therefore, the V-belt must be checked in short time distances. It may be possible, that the V-belt must be changed after a few weeks. Therefore the V-belt must be checked every 150 hours. The v-belt must be seen as a wearing part. Therefore it is necessary to have enough spare V-belts on board. We therefore recommend to have the Fischer Panda Service Kit on board.

1. Loose the screw on the upper alternator mounting.



Sample picture

Fig. 9.10-1: Alternator screw

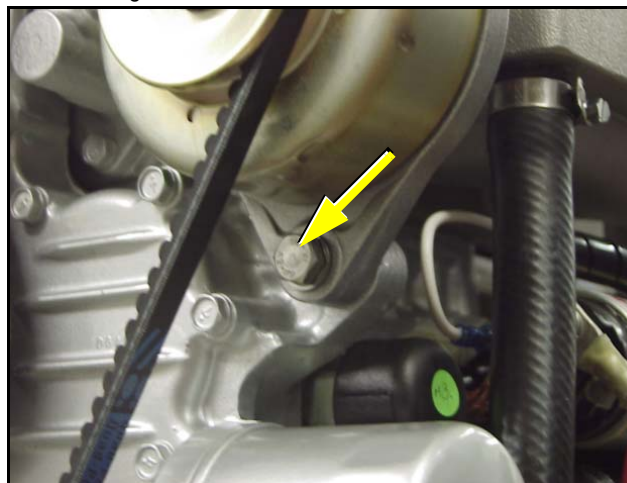


2. Loose the screw underneath the alternator.



Sample picture

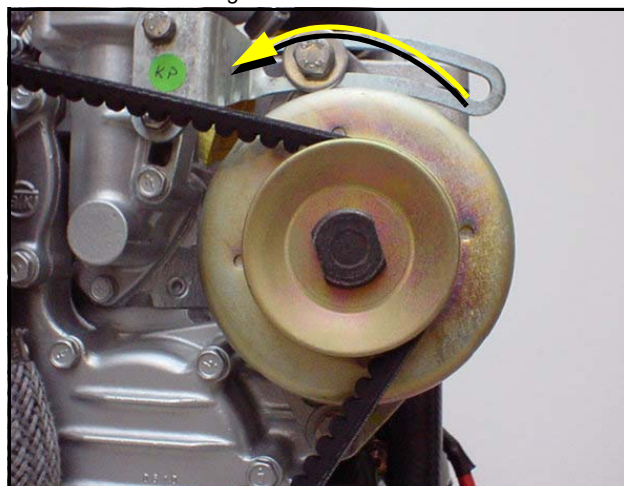
Fig. 9.10-2: Screw underneath the alternator



3. The alternator must be pressed in the direction of the thermostat housing.
4. Exchange the V-belt.

Sample Picture

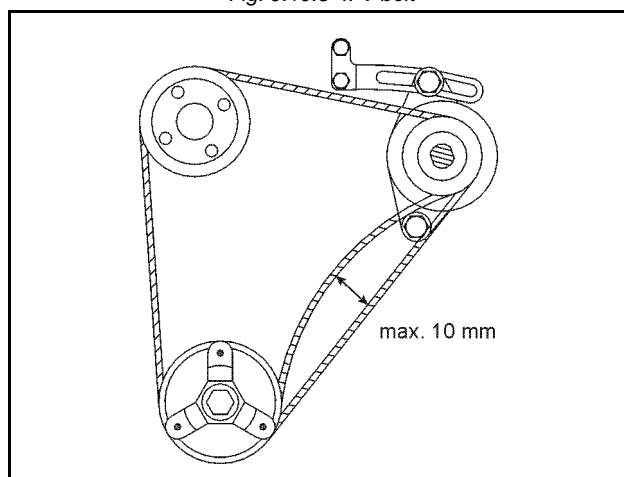
Fig. 9.10.5-3: Alternator



5. Afterwards, the V-belt must be tightened again.
6. The V-belt must be tightened in such a way, that it is possible to press it about approx. 10 mm.
7. Tighten the screws above and underneath the alternator.

Sample picture

Fig. 9.10.5-4: V-belt



9.11 The raw water circuit

9.11.1 Clean raw water filter

The raw water filter should be released regularly from arrears. In each case the water cock must be closed before. It is mostly sufficient to beat the filter punnet.

If water should seep through the cover of the raw water filter, this may be sealed in no case with adhesive or sealant. Rather must be searched for the cause for the leakage. In the simplest case the sealing ring between caps and filter holders must be exchanged.

Fig. 9.11.1-1: Raw water filter



9.12 Causes with frequent impeller waste

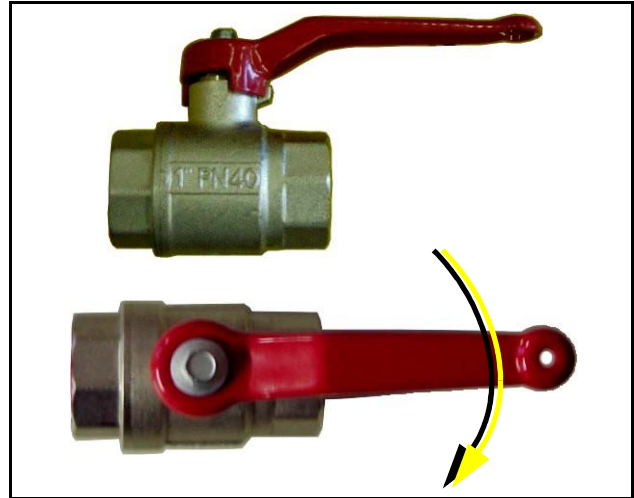
The impeller of the cooling water pump must be regarded as wearing part. The life span of the impeller can be extremely different and exclusively depends on the operating conditions. The cooling water pumps of the PANDA generators are laid out in such a way that the number of revolutions of the pump lies low compared with other gensets. This is for the life span of the pump a positive effect. Unfavourable affects the life span of the impeller, if the cooling water sucking in way is relatively long or the supply is handicapped, so that the cooling water sucking in range develops a negative pressure. This can reduce first of all the power of the cooling water pump extremely that the wings of the impeller are exposed to very strong loads. This can shorten the life span extremely. Further the operation of the impeller pump loaded in waters with a high portion of suspended matters. The use of the impeller pump is particularly critical in coral water bodies. Cases are well-known, which a impeller pump had so strongly run after 100 hours already that the lip seal on the wave was ground in. In these cases sharp crystal parts of the coral sand assess in the rubber seal and affect like an abrasive the high-grade steel shank of the impeller pump. If the generator were mounted over the water level it is particularly unfavourable for the impeller pump. After the first start some seconds will pass by, until the impeller can suck in cooling water. This short unlubricated operation time damages the impeller. The increased wear can lead after short time to the loss. (see special notes: "Effects on the impeller pump, if the generator is mounted over the waterline")

9.12.1 Replacement of the impeller

Close the raw water stop cock.

Representative picture

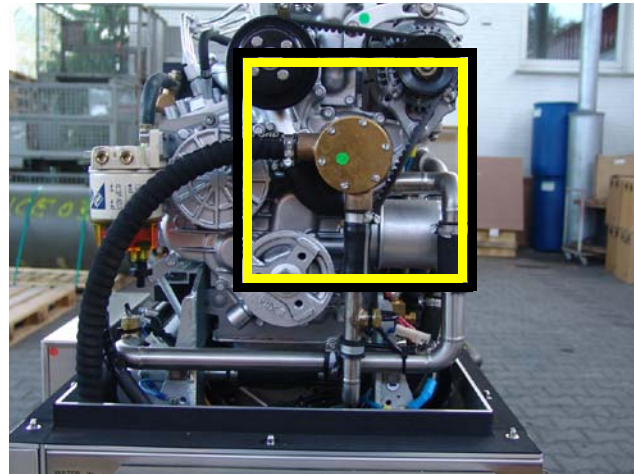
Fig. 9.12.1-1: Raw water cock



Raw water pump on the front side of the genset.

Representative picture

Fig. 9.12.1-2: Raw water pump



Remove the cover of the raw water pump by loosen the screws from the housing.



Representative picture

Fig. 9.12.1-3: Cover raw water pump

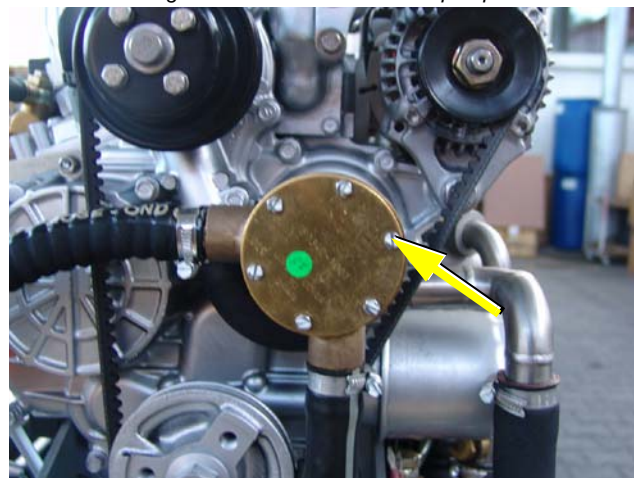
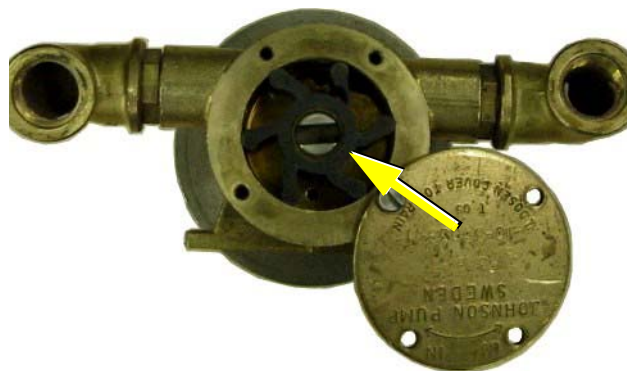


Fig. 9.12.1-4: Impeller pump

Pull to the impeller with a multigrip pliers of the wave.



Mark the impeller, to make sure that these is used in the correct position at re-installation.

Representative picture

Check to the impeller for damage and replace it if necessary.

Before the reinsertion into the housing the impeller should have been lubricated with glycerin or with a non-mineral oil based lubricant e.g. silicone spray.

The impeller is attached to the pump wave (if the old impeller is used, pay attention to the before attached marking).

Representative picture

Fig. 9.12.1-5: Impeller

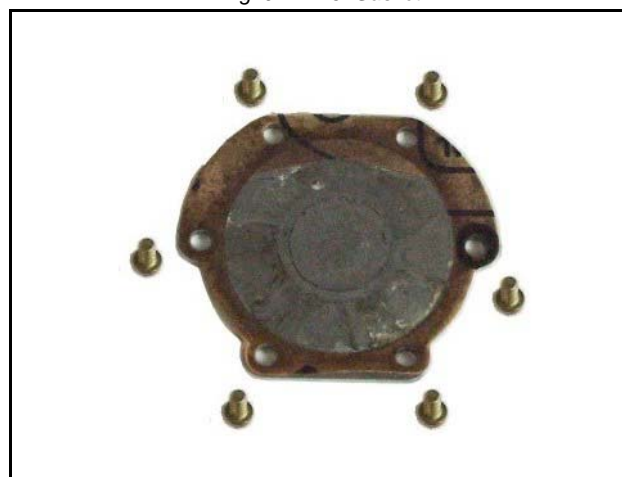


Fastening the cover and use a new seal.



Representative picture

Fig. 9.12.1-6: Gasket



Leere Seite / Intentionally blank

10. Generator Faults

10.1 Personal requirements

The work described here, unless otherwise indicated, are performed by the operator.

More repair work may be performed only by specially trained personnel or by authorized repair shops (Fischer Panda service points). This is especially for working on the valve timing, fuel injection system and the engine repair.

10.2 Hazard notes for the troubleshooting

Follow the general safety instruction at the front of this manual.

Notice!



Danger for life! - The generator can be equipped with an automatic start device. This means the generator can be started by an external signal. To avoid an unexpected starting of the generator, the starter battery must be disconnected before start working at the generator.

Warning!: Automatic start



Working at a running generator can result in severe personal injury. Therefore before starting work at the generator:

Warning!: Risk of injury



Make sure that the generator is stopped and the starter battery is disconnected to guarantee that the generator cannot be inadvertently started.

Do not run the generator with removed sound isolation cover.

Improper installation/maintenance can result in severe personal injuries or material damage.

Warning!: Risk of injury



- Always undertake installation/maintenance work when the generator is switched off.
- Ensure there is sufficient installation clearance before start working.
- Ensure tidiness and cleanliness at the workplace. Loose components and tools lying around or on top of each other are sources of accidents.
- Only perform installation work using commercially available tools and special tools. incorrect or damaged tools can result injuries.

Oil and fuel vapours can ignite on contact with ignition sources. Therefore:

Warning!: Danger of fire



- No open flames during work on the generator.
- Do not smoke.
- Remove oil and fuel residues from the generator and floor.

Contact with engine oil, antifreeze and fuel can result in damage to health. Therefore:

- Avoid skin contact with engine oil, fuel and antifreeze.
- Remove oil and fuel splashes and antifreeze from the skin immediately.
- Do not inhale oil and fuel vapours.

Danger for Life. Improper handling, operation, installation and maintenance can result in severe personal injury and/or material damage.

Electrical voltages above 48 volts (battery chargers greater than 36 volts) are always dangerous to life). The rules of the respective regional authority must be adhered to. Only an electrician may carry out installation of the electrical connections for safety reasons.

Generator, oil and antifreeze can be hot during/after operation. Risk of severe burns.

During Installation/maintenance personal protective equipment is required to minimize the health hazards.

- Protective clothing
- safety boots
- protective gloves
- Ear defender
- safety glasses

Disconnect all load during the work at the generator to avoid damages at the load.

Danger!: Danger of poisoning



ATTENTION!: Danger to Life - High voltage



Warning!: Hot surface/material



Instruction!: Personal protective equipment necessary.



Attention!: Disconnect all load



10.3 Tools and Measuring Instruments

In order to be able to manage disturbances while driving, the following tools and measuring instruments should belong to the equipment kept on board:

- Multimeter for voltage (AC), frequency and resistance
- Measuring instrument for inductance
- Measuring instrument for capacity
- Current absorbing clamps
- Thermometer (ideal is a infra-red thermometer)
- Pressure device (pincer) for coolant circuit

10.4 Troubleshooting Table

10.4.1 Generator output voltage too low

For 50 Hz versions: less than 200 V

Fig. 10.4.1-1: Generator output voltage too low

Cause	Solution
Generator is overloaded.	Reduce the electrical load (switch off load)
Motor is not reaching the rated rpm.	Refer to „motor faults“ section.
Defective capacitor(s).	Check capacitors and replace if necessary.

10.4.2 Generator voltage too high (more than 240 V - 50 Hz)

Fig. 10.4.2-1: Generator voltage too high (more than 240 V - 50 Hz)

Cause	Solution
Over-energizing due to wrong capacitors.	Check capacitors type and replace if necessary.

10.4.3 Generator voltage fluctuates

Fig. 10.4.3-1: Generator voltage fluctuates

Cause	Solution
1. Disturbances on the electrical system/user side. 2. Motor disturbances.	1. Check if electrical load is fluctuating. 2. Refer to section: „Motor runs irregular“.

10.4.4 Generator not able to start electric motor

Fig. 10.4.4-1: Generator not able to start electric motor

Cause	Solution
If the generator is unable to supply enough power to start an electric motor 1-phase, it is usually because the motor draws too much current during starting process.	Check the motor's current draw required for starting (switch to 3-phase, if possible). This could be remedied by providing stronger capacitors or installing an optional „Easy Start Booster Set“ (see Appendix). Enquire at your nearest Panda dealer or directly at the manufacturer.

10.4.5 Diesel motor fails to start

Fig. 10.4.5-1: Diesel motor fails to start

Cause	Solution
Starter battery switched „OFF“.	Check position of battery switch and switch „ON“ (if installed).
Starter battery voltage insufficient (battery too weak).	Inspect battery terminals and cables for a good electrical connection (Inspect against corrosion, tattered wires, etc.).
Starting current disrupted.	During the normal starting process, the battery voltage drops to 11V with a fully charged battery. If the voltage does not drop during starting, the electrical connection is faulty. If the battery voltage drops lower than 11V, then the battery has been discharged.

10.4.6 Starter is turning motor, but fails to start

Fig. 10.4.6-1: Starter is turning motor, but fails to start

Cause	Solution
Fuel inlet solenoid valve not opening.	Check wire connections and circuitry to solenoid valve. (ref. DC wiring diagram: Relay K2, Fuse)
Fuel pump not working.	Check fuel-filter and pump: clean if necessary.
Lack of fuel.	Check fuel supply.
Glow-plugs not working correctly.	Check glow plugs and heating time.
Too much air in fuel lines.	Test fuel system for leakage. Bleed air from fuel system (refer to section „Bleeding Air from Fuel System“).
Fuel-filter blocked.	Replace fuel filter.

10.4.7 Motor does not achieve enough speed during starting process

Fig. 10.4.7-1: Motor does not achieve enough speed during starting process

Cause	Solution
Starter battery voltage insufficient.	Check battery.
Damaged bearing(s) piston (seized).	Repairs need to be carried out by engine manufacturer service, or Fischer Panda representative.
Cooling water in combustion chamber.	<ol style="list-style-type: none"> 1. Turn generator „OFF“ at control panel. 2. Remove the glow plug 3. Rotate the motor by hand carefully. 4. Check if there is water in the oil and change both oil and filter if necessary. 5. Determine cause for excess water in the combustion chamber. The excess water can be caused by a defective air vent in the cooling water system, which should be checked and cleaned, or replaced if faulty.

10.4.8 Motor runs unsteady

Fig. 10.4.8-1: Motor runs unsteady

Cause	Solution
Disruption in the area of the injection systems' automatic advance.	Repair / Check the automatic advance via the motor service.
Air in the fuel system.	Ventilate the fuel system.

10.4.9 Motor speed drops

Fig. 10.4.9-1: Motor speed drops

Cause	Solution
Lack of fuel	Check fuel supply system: - fuel filter, renew if necessary - check fuel pump - check fuel lines (bleed if necessary)
Lack of intake air.	Check air intake paths. Check and clean air filter (and intake muffler if installed).
Generator overloaded by too many load.	Reduce the electrical load (switch off load).
Generator overloaded by over-energizing.	Check that the proper capacitor type is installed and that they are connected correctly.
Defective generator (windings, bearings, or other).	Generator must be sent to manufacturer for repair of damaged bearings or winding.
Damaged engine.	Repair of bearing damage, etc., by engine manufacturer service, or Fischer Panda representative.

10.4.10 Motor runs in off position

Fig. 10.4.10-1: Motor runs in off position

Cause	Solution
Fuel inlet solenoid valve or throttle shut solenoid is not switching off.	Check wire connections to solenoid. Check valve functions as in the „Fuel Solenoid Valve“ or in the throttle shut off solenoid sections. Replace if necessary.

10.4.11 Motor stops by itself

Fig. 10.4.11-1: Motor stops by itself

Cause	Solution
Lack of fuel.	Check fuel supply system.
Excess heat in cooling system (thermo switch tripped)-lack of cooling water. Is indicated on the remote control panel.	Check cooling water system flow: water pump, inlet water filter, extra heat exchanger coolant flow.
Lack of oil pressure sensor tripped). Is indicated on the remote control panel.	Check oil-level and if necessary top up. Check motor's oil-pressure and have repaired by engine manufacturer service, or Fischer Panda representative.

10.4.12 Sooty, black exhaust

Fig. 10.4.12-1: Sooty, black exhaust

Cause	Solution
Generator is overloaded.	Check electrical load and switch off unnecessary load.
Insufficient intake air.	Check intake air filter; clean if necessary.
Fuel injector faulty.	Replace injector.
Valve clearance incorrect.	Readjust valve clearance to correct value (refer to Farymann-manual).
Poor fuel quality.	Use better quality diesel (recommended: 2-D Diesel).
Poor combustion.	Incorrect AFR (air/fuel ratio) due to motor timing adjustment. Engine maintenance by engine manufacturer service, or Fischer Panda representative.

10.4.13 Generator must be shut off immediately if:

Fig. 10.4.13-1: Generator must be shut off immediately if:

Cause	Solution
<ul style="list-style-type: none"> - motor rpm suddenly rises or drops - unusual noise comes from genset - exhaust colour suddenly becomes dark - leakage in the cooling water system. 	<p>Refer to respective section of manual and if necessary, have repaired by engine manufacturer service, or Fischer Panda representative.</p>

10.5 Overloading the generator

Please ensure that the generator is not overloaded. This must be considered, especially with regards to multi power generators. In this case the extra load including the electrical performance can be considerably greater than the drive performance of the motor, which can eventually lead to a damaged motor.

The full nominal performance of the generator is fore-mostly for short term use. It is, however, required to start electric motors with high starting current or achieve special starting procedures at peak loads. 70% nominal load is ideal for a long motor life. (Continual use means uninterrupted use of the generator for many hours). This should be taken into consideration when connecting devices. This ensures extended motor life.

It is no problem for the motor to be run occasionally for 2 - 3 hours at full load. The complete conception of Panda Generator ensures that even during extreme conditions, an overheating of the motor will not occur. Accumulation of soot will occur if run for long periods at full load.

Effects of Short Circulating and Overloading on the Generator

The generator cannot be damaged by short-circuit or overloading. Short-circuit and overloading suppress the magnetic excitation of the generator, thus, no current is generated and the voltage will collapse. This condition is immediately offset, once the short circuit has been eliminated and/or the electrical overload removed.

Overloading the Generator with Electric Motors

With the operation of electric motors it must be considered that these take up a multiple of their rated output as starting current (six to tenfold).

If the power of the generator for the engine is not sufficient, the voltage in the generator breaks down after switching on the engine. For special approach problems the manufacturer can give recommendations regarding the accomplishment of the situation (e.g. amplified condensers, gradual start switch or extra developed starting unit for electric motors).

The system efficiency can be improved up to 50% and the starting current can be improved up to 100% by a professional adjustment of the engines. If the inductive load (electrical motors etc.) lies over 20% of the generator rated output compensation is appropriate (see in addition also the writing: „Operation Instructions for Generators with Inductive Loads“).

10.5.1 Monitoring the Generator Voltage

see “Safety first!” on Page 12.

ATTENTION!



The voltage range of the power stations normally lies between 200 and 240 V (100 - 130 V in the 60 Hz version). In some countries even substantially larger tension deviations are being called „normally“. The Fischer Panda generators are aligned that they keep these default values during normal load.

With high load or overload it can occur that the voltage drops on 190 V (95 V in the 60 Hz version) and partly still more deeply. That can become critical for certain devices (e.g. for electric motors, cooling compressors and possibly for electronic devices). It must be paid attention that the voltage for such consumers are sufficient. This can be supervised by a voltmeter.

The voltmeter should be always installed behind the change over switch generator/land power, so that each voltage source is shown. No further voltmeter is provided for the generator itself.

If additional consumers are switched on, the voltage must be controlled in each case at the voltmeter. Sensitive devices must be switched off so long, until the voltage exceed the critical parameter.

Under certain circumstances the generator provides over voltage. This arises if the number of revolutions of the generator is increased. Changing the number of revolutions may be made only with a tachometer and/or a voltmeter.

If sensitive and/or valuable devices are used, which are to be protected against this risk, an automatic over voltage protection must be mounted (voltage control with disconnection).

10.5.2 Automatic voltage monitoring and auto-shut down

If air conditioning units (compressors) or other such valuable equipment is installed on-board, it is recommend that an automatic voltage monitoring unit be installed to protect this equipment from possible sharp voltage drops. The voltage monitoring system shuts down the entire system (and therefore all users) by means of a circuit breaker relay as soon as the voltage falls below a set value (the monitor will also shut down the on-board grid automatically when the generator is stopped). Such a relay with contactor can be obtained from the installation or as a complete unit from your Fischer Panda dealer.

10.6 Generator-Output Voltage is too low

If the AC generated is too low, then the consumers should be disconnected, one after the other, in order to reduce the load on the generator. Generally the problem is then solved. The frequency should be checked, if the output voltage is correct after the consumers have been disconnected. Should this be above the prescribed generator idling speed, it can be assumed that one or several capacitors are defective.

10.7 Generator provides no voltage

10.7.1 Rotor Magnetism Loss and „Re-magnetising“

See “Safety Instructions - Safety First!” on Page 17.

ATTENTION!



In the case of asynchronous generators, the generator cannot independently increase voltage after standing still, or, if it is switched off under full load. This is because the rotor has lost its remaining magnetism.

This remaining magnetism can be restored by Fischer Panda or service partner.

10.8 Engine Starting Problems

10.8.1 Lifting solenoid for motor stop - optional

There are two different versions of lifting solenoids:

A. Energized to stop

The lifting solenoid is furnished with voltage and pulled by pushing the „OFF“-button on the remote control panel. By doing that, the injection pump is set on zero lift and the generator stops.

B. Energized to run

This version is equipped with two solenoids, an operation- and a holding solenoid. After applying voltage, the operation solenoid pulls the adjusting lever of the injection pump, which gives way to the fuel. After reaching its end position, the operation magnet is switched off and the holding solenoid keeps that position as long as the generator is operating.

The „START“-button should not be pressed any longer than 5 sec. during the starting process, or the lifting solenoid draws too much current over the starter motor. Otherwise the lifting solenoid needs to be disconnected.

ATTENTION!



Lifting solenoid for motor stop

Sample Picture

Fig. 10.8.1-1: Lifting solenoid for motor stop



Damage to starter motor

The starter is fitted with a free wheel or axial rotating spring cog, which prevents the starter being driven externally by means of the motor. The free wheel will be heavily worn, if the starter still operates, thereby causing damage to the springs, roller bearings or cog teeth. This could lead to complete destruction of the starter.

It is important that every person who operates the generator is informed of this situation. This is practically the only handling error that can be made on board that can lead to fatal consequences for both generator and operator.

Leere Seite / Intentionally blank

11. Tables

11.1 Technical data

For the technical data of the engine, see engine manufacturer manual.

11.2 Fuel

Use a clean Diesel fuel oil according to DIN590:1999 or better. For Generators with common rail or particle filter use DIN590:2009 or better.

Do not use alternative fuel, because its quality is unknown or it may be inferior in quality. Kerosene, which is very low in cetane rating, adversely affects the engine.

11.3 Engine oil

11.3.1 Engine oil classification

11.3.1.1 Operating range:

The operating range of an engine oil is determined by SAE class. „SAE“ is for the union of American auto engineers (Society of Automotives Engineers).

The SAE class of an engine oil only informs over the viscosity of the oil (larger number = more viscous, smaller number = more highly liquidly) e.g. to 0W, 10W, 15W, 20, 30, 40. The first number shows the liquid of the oil with cold weather, the second number refers to the fluidity with heat. Complete yearly oils have usually SAE classes of SAE 10W-40, SAE 15W-40 etc.

11.3.1.2 Quality of oil:

The quality of an engine oil is specified by the API standard („American Petroleum Institutes“).

The API designation is to be found on each engine oil bundle. The first letter is always a C.

API C for diesel engines

The second letter is for the quality of the oil. The more highly the letter in the alphabet, the better the quality.

API C for diesel engine

Examples for diesel engine oil:

API CC Engine oil for small demands

API CD Engine oil for suction- and turbo diesel engine

API CF Replace the specification API CD since 1994

API CG Engine oil for highest demands, turbo-tested

See technical data for the specified engine oil

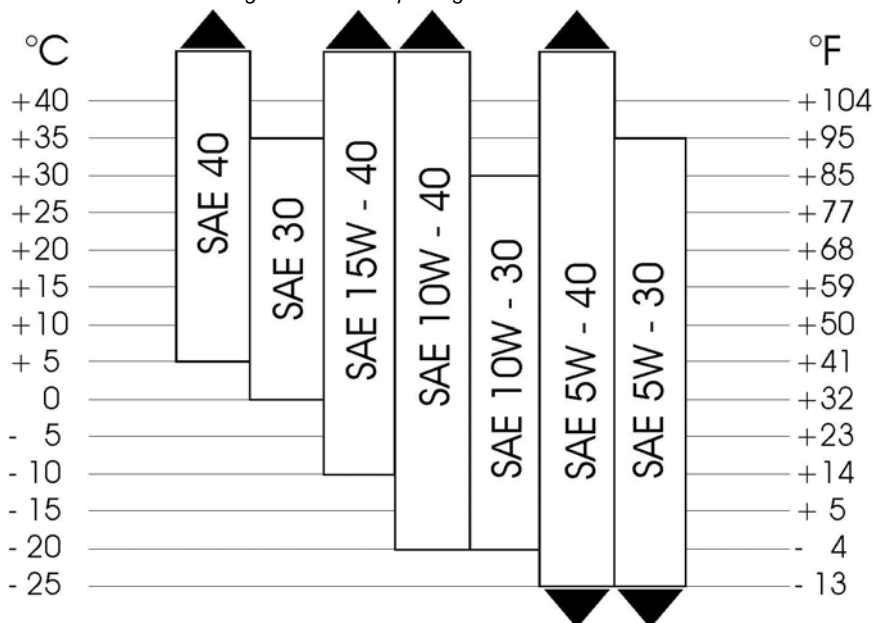
Notice!:



Fig. 11.3.1.2-1: Engine oil type.

Engine oil type	
over 25 °C	SAE30 or SAE10W-30; SAE10W-40
0 °C to 25 °C	SAE20 or SAE10W-30; SAE10W-40
below 0 °C	SAE10W or SAE10W-30; SAE10W-40

Fig. 11.3.1-2: Temp. range of the SAE classes



11.4 Coolant specifications

Use a mixture of water and antifreeze. The antifreeze needs to be suitable for aluminium. The antifreeze concentration must be regularly checked in the interests of safety.

Fischer Panda recommend to use the product: GLYSANTIN PROTECT PLUS/G 48

Engine coolant automotive industry Product description	
Product name	GLYSANTIN ® PROTECT PLUS / G48
Chemical nature	Monoethylenglycol with inhibitors
Physical form	Liquid

Chemical and physical properties		
Reserve alkalinity of 10ml	ASTM D 1121	13 – 15 ml HCl 01 mol/l
Density, 20 °C	DIN 51 757 procedure 4	1,121 – 1,123 g/cm ³
Water content	DIN 51 777 part 1	max. 3,5 %
pH-value undiluted		7,1 – 7,3

11.4.1 Coolant mixture ratio

Water/antifreeze	Temperature
70:30	-20 °C
65:35	-25 °C
60:40	-30 °C
55:45	-35 °C
50:50	-40 °C

11.5 Diameter of conduits

Fig. 11.5-1: Diameter of conduits

Generator type	Ø Cooling water conduit		Ø Exhaust conduit [mm]	Ø Fuel conduit	
	Freshwater [mm]	Seawater [mm]		Supply [mm]	Return [mm]
Panda PMS 3,8 ND	12	12	30	8	8
Panda PMS 4,5 ND	12	12	30	8	8
Panda PMS 4500 SCB	12	12	30	8	8
Panda PMS 5000 SCE	12	12	30	8	8
Panda PMS 4500 FCB	12	12	30	8	8
Panda PMS 5000 LPE	16	16	30	8	8
Panda PMS 6000 ND	20	20	40	8	8
Panda PMS 8000 NE (8 mini Digital)	20	20	40	8	8
Panda PMS 9000 ND	20	20	40	8	8
Panda PMS 12000 NE (12 mini Digital)	20	20	40	8	8
15 mini Digital	20	20	40	8	8
Panda PMS 14000 NE	20	20	40	8	8
Panda PMS 18 NE (16 Digital)	25	20	50	8	8
Panda PMS 24 NE (22/25 Digital)	25	20	50	8	8
Panda PMS 30 NE	25	20	50	8	8
Panda PMS 33 KU	30	25	50	8	8
Panda PMS 42 KU	30	30	50	8	8
Panda PMS 32 YA	30	30	50	8	8
Panda PMS 50 YA	30	30	60	8	8
Panda PMS 60 YA	-	-	60	8	8
Panda PMS 50 MB	40	30	60	8	8
Panda PMS 60 MB	40	40	60	8	8
Panda PMS 60 Hatz		30	76	13	13
Panda PMS 75 MB	40	30	60	8	8
Panda PMS-HD 7,5-4 KU	25	20	40	8	8
Panda PMS-HD 09-4 KU	25	20	50	8	8
Panda PMS-HD 12-4 KU	25	20	50	8	8
Panda PMS-HD 17-4 KU	25	25	60	8	8
Panda PMS-HD 22-4 KU	30	30	60	8	8
Panda PMS-HD 30-4 KU	30	30	60	8	8
Panda PMS-HD 40-4 KU	30	30	60	8	8
Panda PMS-HD 60-4 DZ	-	-	-	-	-

Generator type	Ø Cooling water conduit		Ø Exhaust conduit [mm]	Ø Fuel conduit	
	Freshwater [mm]	Seawater [mm]		Supply [mm]	Return [mm]
Panda PMS-HD 70-4 DZ	-	-	-	-	-
Panda PMS-HD 85-4 DZ	-	-	-	-	-
Panda PMS-HD 110-4 DZ	-	-	-	-	-
Panda PMS-HD 130-4 DZ	-	-	-	-	-

11.6



Fischer Panda®

Power
wherever
you are™



Panda xControl Manual

Current revision status

	Document
Current:	Panda_xControl_eng.R02_26.2.18
Replaces:	Panda_xControl_eng.R01.5

Revision	Page
Manual compiled on the basis of deu R02	

Created by

Fischer Panda GmbH - Head of Technical Documentation

Otto-Hahn-Str. 32-34

33104 Paderborn - Germany

Phone: +49 (0) 5254-9202-0

E-mail: info@fischerpanda.de

web: www.fischerpanda.de

Copyright

Reproduction of and changes to the manual are permitted only by agreement and with the permission of the manufacturer!

Fischer Panda GmbH, 33104 Paderborn, reserves all rights regarding text and graphics in this document. Details are given to the best of our knowledge. No liability is accepted for correctness. Please note: technical modifications aimed at improving the product may be implemented without prior notice. Therefore, it must be ensured prior to installation that the pictures, diagrams, and related material are applicable to the equipment supplied. In case of doubt, verify upon delivery that documentation and equipment match.



Fischer Panda GmbH
 Otto-Hahn-Str. 40
 D-33104 Paderborn
 Germany

Phone: : +49 (0)5254 9202-0
 Fax.: : +49 (0)5254 9202-550
 Hotline : +49 (0)5254 9202-767
 E-mail: : info@fischerpanda.de
 Web : www.fischerpanda.de



12. Panda xControl Safety Instructions

12.1 Personnel

The settings described here can be performed by the operator unless highlighted differently.

The installation should be implemented by specially trained technical personnel or by authorised workshops (Fischer Panda Service Points), only.

12.2 Safety instructions

Adhere to the safety instructions in the Fischer Panda generator manual.

If these instructions are not to hand, they can be requested from Fischer Panda GmbH, 33104 Paderborn, Germany.

Note!



An external signal may trigger an automatic start-up.

WARNING: Automatic start-up



The generator must not be operated with the cover removed.

Warning!



If the generator is being installed without a sound insulation capsule, it must be ensured that all rotating parts (belt pulley, belts etc.) are covered and protected so that there is no danger to life and body!

All service, maintenance, or repair work may only be carried out when the unit is not running.

Electric voltage - Deadly Danger!

WARNING: Electrical voltage

Electric voltages of more than 48 V are potentially lethal in any situation. The rules of the respective regional authority must be adhered to for installation and maintenance.



For safety reasons, only an electrician may carry out the installation of the electrical connections of the generator.

Disconnect battery before working on the generator

Attention!

The battery must always be disconnected (first the negative terminal, then the positive terminal) if work on the generator or electrical system is to be performed, so that the generator cannot be started inadvertently.



This applies in particular to systems with an automatic start-up function. The automatic start-up function shall be deactivated before starting work.

The flooding valve must be closed. (For PMS version only.)

Also observe the safety instructions for the other components of your system.

Note!



13. Panda xControl

The Panda xControl is a generator control system with three main components.

13.1 Components of the xControl

13.1.1 xControl - CP-G

(Control Panel – Generator) - Part No. 21.02.02.204P

Display and Control Element of the xControl

The xControl CP-G is the display and control element

Power is supplied via the bus cable. Multiple control elements can be installed in a single system.

Fig. 13.1.1-1: Control Panel - Generator



13.1.2 xControl - GC-S

(Generator Control - Servo) - Part.No. 21.02.08.019P

Main module of the xControl.

The module contains the control electronics

The xControl GC-S is usually installed in the generator capsule.

The xControl GC-S takes over the monitoring and control of the diesel engine of the Fischer Panda generator, as well as the control of the output voltage and frequency of the generator.

The xControl GC-S is suitable for 12V and 24 V starting systems. The connected actuators are supplied with power via switching outputs with input voltage.

Current measurement is single-phase and can be done directly. A voltage sensor is not necessary. Current measurement takes place via an external current sensor. An additional three-phase module can be used for three-phase generators.

Fig. 13.1.2-1: Generator Control - Servo



13.1.3 xControl - CB-G

(Connection Box - Generator)

The xControl GC-S is usually installed in the generator capsule (externally).

The xControl CB-G is the external terminal block for the xControl generator.

The control element and the fuel pump are connected here.

Fig. 13.1.3-1: Connection Box - Generator



An emergency stop device, auto-start, load relays and boosters can be connected as options.

Only electricians may work on the xControl CB-G

Note:



13.2 Installation

13.2.1 Installation of the Electronic Control Unit (ECU) xControl - GC-S

The ECU xControl - GC-S is pre-installed. The ECU can be exchanged easily. All connections are mechanically coded and prevent the risk of confusion.

13.2.2 Installation of the Connection Box xControl - CB-G

The connection box is pre-installed. External components are connected in accordance with the installation manual and the circuit diagram of the xControl generator.

13.2.3 Installation of the xControl - CP-G

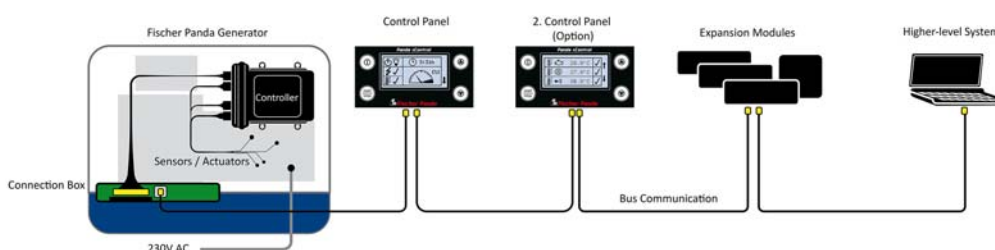
The xControl - CP-G is a CAN Bus module. All Fischer Panda CAN bus modules have two RJ45 ports. One for connection to the module on the CAN bus, the second to relay the CAN bus. The last module on the CAN bus must have a terminating resistor in the RJ45 port.

Connection by means of the Fischer Panda bus cable is mandatory.

Fig. 13.2-1: xControl CP-G rear



Fig. 13.2-2: Connection Diagram



13.3 Operation

The xControl is operated by means of the xControl CP-G panel.

Fig. 13.3-1: xControl CP-G front



13.3.1 Switching on the generator

Press the "ON/OFF" switch to switch on the control system of the generator.

The xControl Generator thereby switches to "standby mode".

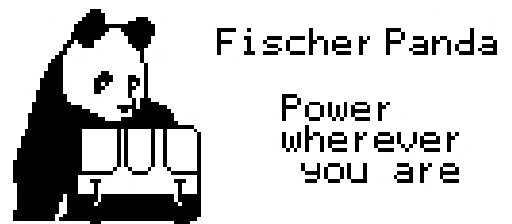
If automatic starting is activated at the menu, the generator can henceforth be started by means of an external signal.

Fig. 13.3.1-1: Switching on the generator



The CP-G Panel displays the home page for two seconds.

Fig. 13.3.1-2: Home Page



The CP-G then displays the address page for one second

Fig. 13.3.1-3: Address Page

```

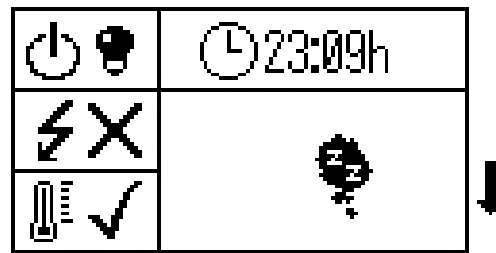
■ addr.: 7
  vers.: V3rff
  serial: 00000.00177
-----
*** addr.: 15
   vers.: V4r27
   serial: 00000.00013
    
```

At the end of the power-on routine, the CP-G displays the first overview page.

The language as well as the display mode can be set in the menu.

Overview Page 1 is the same in all display modes/languages.

Fig. 13.3.1-4: Overview Page 1



13.3.1.1 Overview page with Autostart activated

Deadly danger! - The generator can be equipped with an Autostart function. This means that the generator is started by an external signal. In order to prevent an inadvertent start-up, the starter battery must be disconnected before work on the generator may commence.

WARNING: Autostart



The "Autostart" also remains active if the xControl CP-G is switched off and then on again.

If a fault should arise when the generator is started or is already operating, it is stopped and the Autostart is set to "off".

If the generator is operated by Autostart and is stopped manually, the Autostart is set to "off".

Once the system has been switched off and then on again, the Autostart is active once more.

The first overview page shows if the Autostart is active.

Fig. 13.3.1-1: Overview Page 1 with Autostart

Overview Page 1 with Autostart function activated.



13.3.2 The overview pages

The display mode/language of the display can be set in the menu.

13.3.3 Symbols used in overview pages

Overview Page 1:

- 01. Generator Status (on/off)
- 02. AC OK
- 03. Temperature of the generator (OK/Error)
- 04. Operating hours of the generator
- 05. Info screen

Overview Page 1 is the same in all languages.

Overview Page 2 (Generator):

- 06. Output voltage [V]
- 07. Generator current [A]
- 08. Generator apparent power [kVA]

Fig. 13.3.3-1: Symbols used in Overview Page 1

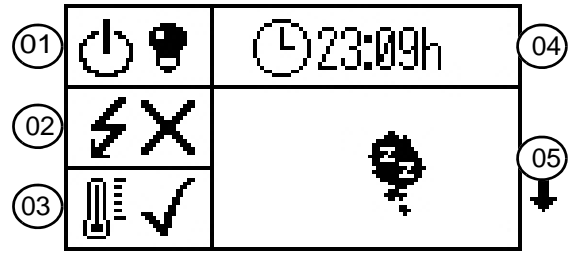
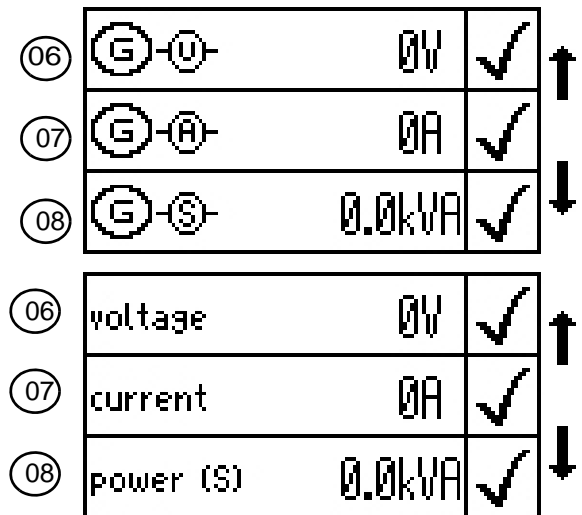


Fig. 13.3.3-2: Overview Page 2 Symbols/English



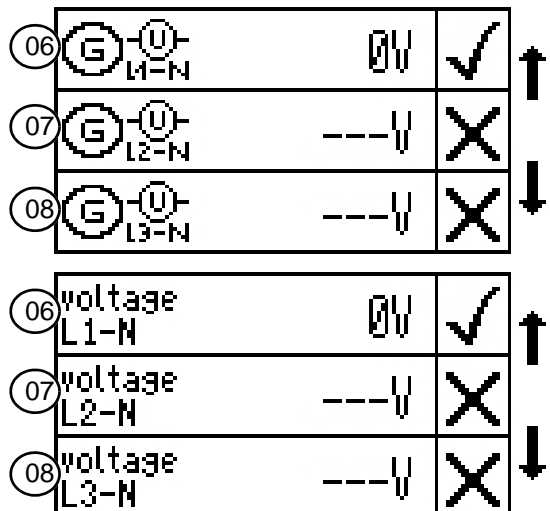
In the case of three-phase generators, the voltage, the current and the electrical power are shown on separate pages. Each page shows the value of the three phases one below the other.

Example of the voltage display of a 3-phase generator.

Note:






Fig. 13.3.3-3: Voltage display 3-P Symbols/English



Overview Page 3:

- 09. Frequency of the generator [Hz]
- 10. Generator speed (r.p.m.)
- 11. Voltage of the starter battery [V]




Fig. 13.3.3-4: Overview Page 3 Symbols/English

09		0.0Hz	✓	↑ ↓
10		0rpm	✓	
11		13.2V	✓	
09	frequency	0.0Hz	✓	↑ ↓
10	rotational speed	0rpm	✓	
11	bat.-volt.	13.1V	✓	

Overview Page 4:

- 12. Temperature of the cylinder head
- 13. Temperature of the generator winding
- 14. Temperature at exhaust manifold

Fig. 13.3.3-5: Overview Page 4 Symbols/English

12		---°C	✗	↑ ↓
13		---°C	✗	
14		---°C	✗	
12	engine temperature	---°C	✗	↑ ↓
13	winding temperature	---°C	✗	
14	exhaust temperature	---°C	✗	

If the information pages of optional components (e.g. fuel gauge, oil pressure) are available, then these pages are inserted after Overview Page 4.

Whether these pages are displayed automatically, always or not at all can be set in the Panel menu.

Final Overview Page:

Proceed to this menu by pressing the Start/Stop - Enter key

Overview Page 5 is the same in all display modes/languages.

Note!:



Fig. 13.3.3-6: Final overview page



13.4 Starting up the generator

13.4.1 Preparations for starting up / Checks (daily) for marine version

1. Oil level check (ideal level: 2/3 Max).

The level should be about 2/3 of the maximum level when the engine is cold.

Further, if installed, the oil level of the oil-cooled bearing must be checked before each start - see sight glass on generator front cover!.

2. Check cooling water level.

The external expansion tank should be filled to 1/3 in a cold state. It is very important that there is sufficient volume for expansion of the coolant.

3. Check if the raw water intake valve is open.

For safety reasons, the raw water intake valve must be shut after the generator has been switched off. It should be re-opened before starting the generator.

4. Check raw water filter.

The raw water filter must be regularly checked and cleaned. If the raw water intake is restricted by detached residue, this increases wear on the impeller.

5. Visual inspection

Control fixing bolts, check hose connectors for leaks, check electrical connections. Check electrical lines for damage/chafing.

6. Switch off loads.

The generator should only be started without a load.

7. Open fuel valve, if installed.

8. Close main battery switch (switch on).

13.4.2 Preparations for starting up / Checks (daily) for vehicle version

1. Oil level check (ideal level: 2/3 Max).

The level should be about 2/3 of the maximum level when the engine is cold.

Further, if installed, the oil level of the oil-cooled bearing must be checked before each start - see sight glass on generator front cover!.

2. Check cooling water level.

The external expansion tank should be at 1/3 in a cold state. It is very important that there is sufficient volume available for expansion of the coolant.

3. Visual inspection

Control fixing bolts, check hose connectors for leaks, check electrical connections. Check electrical lines for damage/chafing.

4. Switch off loads.

The generator should only be started without a load.

5. Open fuel valve, if installed.

6. Close main battery switch (switch on).

13.4.3 Starting up the generator

Deadly danger! - The generator can be equipped with an Autostart function. This means that the generator is started by an external signal. In order to prevent an inadvertent start-up, the starter battery must be disconnected before work on the generator may commence.

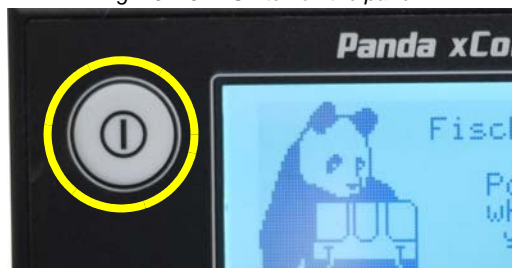
WARNING: Automatic start-up



1. Switch on the xControl CP-G

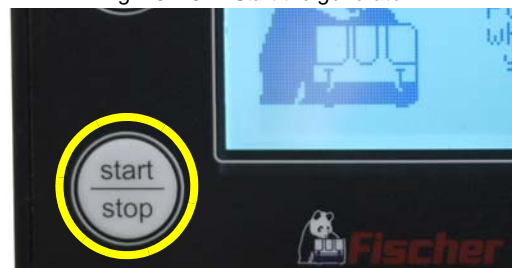
The remote control panel is started by pressing the On/Off button. The On/Off button must be pressed until the Home page is displayed.

Fig. 13.4.3-1: Switch on the panel



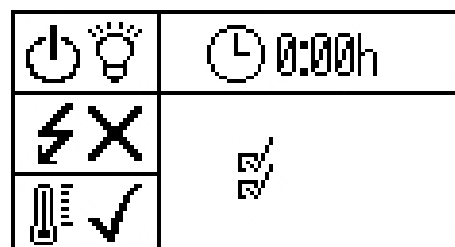
2. Press the Start/Stop - Enter key

Fig. 13.4.3-2: Start the generator.



3. The xControl performs a self-test.

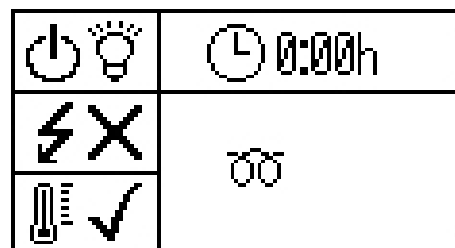
Fig. 13.4.3-3: Self-test



4. The xControl preheats the diesel engine.

Fig. 13.4.3-4: Preheating

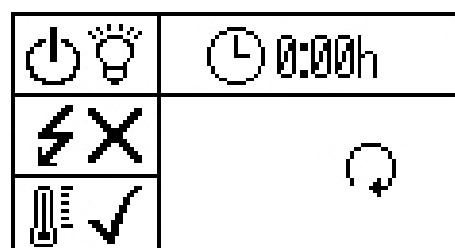
After preheating, the generator is started by the xControl system.



5. Starter on.

Fig. 13.4.3-5: Electric starter

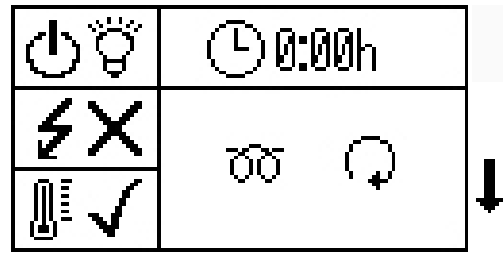
In order to minimise current consumption, preheating is interrupted briefly when the starter is operated.



6. Starter and preheater

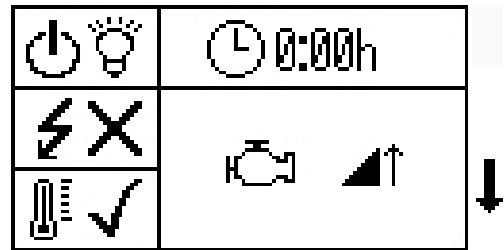
As soon as the high inrush current of the starter has dropped, preheating is switched on again.

Fig. 13.4.3-6: Preheating



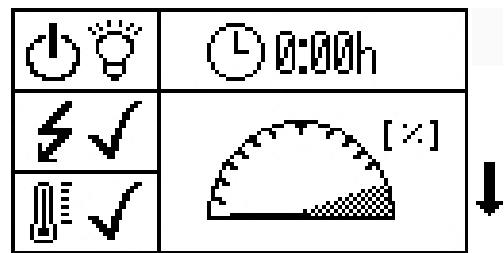
The engine idles for the first few seconds. Thereafter, the xControl increases the speed to the operating speed and indicates this in the display.

Fig. 13.4.3-7: Increase revolutions



As soon as the AC voltage is within the limits (200-250V) (normal operating mode), the load can be connected.

Fig. 13.4.3-8: AC OK



Close the raw water intake valve in the event start-up problems (Panda Marine generators only)

ATTENTION:



If multiple attempts to start up are required (e.g. to bleed the fuel lines), then the raw water intake valve must definitely be shut while the attempts are being made. The cooling water impeller turns during the starting process and feeds cooling water. As long as the engine has not started up, the exhaust gas pressure is insufficient to discharge the coolant water that has been introduced. This protracted start-up process would flood the exhaust system with water. This can damage/destroy the generator/engine.

Re-open the raw water intake valve as soon as the generator has started.

13.4.4 Stopping the generator

1. Switch off loads.
2. Recommendation: With turbo engines and under a load that exceeds 70 % of the rated output, allow the generator temperature to stabilise for at least 5 minutes with load switched off.

At higher ambient temperatures (greater than 25 °C) the generator should always run for at least 5 minutes without load before it is switched off, regardless of the load having been switched off.

3. Press "Start/Stop" button (switching off).

Fig. 13.4.4-1: Stopping



NOTE: Never switch off the main battery until the generator has stopped, shut the fuel valve if necessary!

ATTENTION:



13.5 The Menu

One can access the menu from the final overview page.

Fig. 13.5-1: Menu entry symbols

Switch on the CP-G and scroll down to "Enter Menu Page".

Press the Start/Stop - Enter key to enter the menu.



13.5.1 Main Menu

You can choose from the following sub-menus in the main menu:

Fig. 13.5.1-1: Main Menu



1. "Panel" sub-menu - The display of the of the panel can be adapted in the "Panel" sub-menu (e.g. brightness, language, etc.).
2. "Generator" sub-menu - All settings related to the generator can be made in the "Generator" sub-menu, e.g. bleeding the fuel pump etc.
3. The "Service" sub-menu is blocked and can only be accessed by trained personnel and Fischer Panda employees.
4. Back - back to the overview pages

13.5.2 Sub-menu: "Panel"

The following items can be selected in the Panel sub-menu:

1. Lighting
 - changes the brightness of the display in normal mode.
 2. Contrast
 - changes the contrast of the display.
 3. Standby Time
 - to set the time until the panel switches to standby mode.
 4. Standby Lighting
 - changes the brightness of the display in standby mode.
 5. Display Mode
 - changes the display mode of the overview pages.
 6. Language selection
 - changes the language of the panel
 7. Temperature Unit
 - to set the temperature unit to °C or °F
 8. Audible alarm
 - to activate the audible alarm in the event of a fault
 9. Flashing when faulty
 - to activate panel flashing in the event of a fault
 10. Panel heating
 - activates panel heating at temperatures $<+10^{\circ}\text{C}$
 11. Reset to standard
- The "Panel" sub-menu
12. is reset to the factory settings
 - Switching from the "Panel" sub-menu to the Main Menu

Fig. 13.5.2-1: Sub-menu: Panel

```

brightness
contrast
standby-timeout
standby-brightness
way of illustration
choose language
temperature unit

acoustic alert
blink on error
panel-heater
opt. measured data
reset to standard
back
-----

```

13.5.2.1 Setting the illumination of the CP-G

The menu item is selected by using the "Step-up"/"Step-down" keys confirmed with the "Start/Stop - Enter" key. The respective menu item opens.

The value is changed by using the "Step-up"/"Step-down" keys and the setting is confirmed with the "Start/Stop - Enter" key.

"Cancel" or "Confirm" can be selected by using the "Step-up"/"Step-down" keys and then confirmed with the "Start/Stop - Enter" key.

Fig. 13.5.2.1-1: Sub-menu: Illumination

```

minimum value      0%
brightness         89%
maximum value     100%

cancel
confirm
    
```

13.5.2.2 Setting the contrast of the CP-G

The menu item is selected by using the "Step-up"/"Step-down" keys confirmed with the "Start/Stop - Enter" key. The respective menu item opens.

The value is changed by using the "Step-up"/"Step-down" keys and the setting is confirmed with the "Start/Stop - Enter" key.

"Cancel" or "Confirm" can be selected by using the "Step-up"/"Step-down" keys and then confirmed with the "Start/Stop - Enter" key.

Fig. 13.5.2.2-1: Sub-menu: Contrast

```

minimum value      0%
contrast           24%
maximum value     100%

cancel
confirm
    
```

13.5.2.3 Setting the standby time of the CP-G

The menu item is selected by using the "Step-up"/"Step-down" keys confirmed with the "Start/Stop - Enter" key. The respective menu item opens.

The value is changed by using the "Step-up"/"Step-down" keys and the setting is confirmed with the "Start/Stop - Enter" key.

"Cancel" or "Confirm" can be selected by using the "Step-up"/"Step-down" keys and then confirmed with the "Start/Stop - Enter" key.

Fig. 13.5.2.3-1: Sub-menu: Standby Time

```

minimum value      1min
standby in         60min
maximum value     60min

cancel
confirm
    
```

13.5.2.4 Setting the standby illumination of the CP-G

The menu item is selected by using the "Step-up"/"Step-down" keys confirmed with the "Start/Stop - Enter" key. The respective menu item opens.

The value is changed by using the "Step-up"/"Step-down" keys and the setting is confirmed with the "Start/Stop - Enter" key.

"Cancel" or "Confirm" can be selected by using the "Step-up"/"Step-down" keys and then confirmed with the "Start/Stop - Enter" key.

Fig. 13.5.2.4-1: Sub-menu: Standby Illumination

```

minimum value      0%
stb. bright.      10%
maximum value     100%

cancel
confirm
    
```

13.5.2.5 Setting the display mode of the CP-G overview page

The menu item is selected by using the "Step-up"/"Step-down" keys confirmed with the "Start/Stop - Enter" key. The

respective menu item opens.

"Symbolic View" or "Text View" can be selected by using the "Step-up"/"Step-down" keys and then confirmed with the "Start/Stop - Enter" key.

The "Back" item returns you to the "Panel" sub-menu.

"Cancel" or "Confirm" can be selected by using the "Step-up"/"Step-down" keys and then confirmed with the "Start/Stop - Enter" key.

Fig. 13.5.2.5-1: Sub-menu: Display Mode

```
-----
>symbolic view
text-view
back
-----
```

```
cancel
confirm
```

13.5.2.6 Setting the language of the text pages of the CP-G

The menu item is selected by using the "Step-up"/"Step-down" keys confirmed with the "Start/Stop - Enter" key. The respective menu item opens.

Select the corresponding language by using the "Step-up"/"Step-down" keys and then confirm with the "Start/Stop - Enter" key.

"Cancel" or "Confirm" can be selected by using the "Step-up"/"Step-down" keys and then confirmed with the "Start/Stop - Enter" key.

Fig. 13.5.2.6-1: Sub-menu: Language Selection

```
Deutsch
>English
chinese
back
-----
```

```
cancel
confirm
```

13.5.2.7 Setting the Temperature Unit

The menu item is selected by using the "Step-up"/"Step-down" keys confirmed with the "Start/Stop - Enter" key. The respective menu item opens.

"°C" for "degrees Celsius" or "°F" for "degrees Fahrenheit" can be selected by using the "Step-up"/"Step-down" keys and then confirmed with the "Start/Stop - Enter" key.

The "Back" item returns you to the Panel sub-menu.

"Cancel" or "Confirm" can be selected by using the "Step-up"/"Step-down" keys and then confirmed with the "Start/Stop - Enter" key.

Fig. 13.5.2.7-1: Sub-menu: Temperature Unit

```
-----
>°C
°F
back
-----
```

```
cancel
confirm
```

13.5.2.8 Setting the Aural Alarm

The menu item is selected by using the "Step-up"/"Step-down" keys confirmed with the "Start/Stop - Enter" key. The respective menu item opens.

"Off" or "On" can be selected by using the "Step-up"/"Step-down" keys and then confirmed with the "Start/Stop - Enter" key.

The "Back" item returns you to the Panel sub-menu.

"Cancel" or "Confirm" can be selected by using the "Step-up"/"Step-down" keys and then confirmed with the "Start/Stop - Enter" key.

Fig. 13.5.2.8-1: Sub-menu: Aural Alarm

```
-----
>off
on
back
-----
cancel
confirm
```

13.5.2.9 Setting the display to flash in the event of a fault

The menu item is selected by using the "Step-up"/"Step-down" keys confirmed with the "Start/Stop - Enter" key. The respective menu item opens.

"Off" or "Error" or "Warning and Error" can be selected by using the "Step-up"/"Step-down" keys and then confirmed with the "Start/Stop - Enter" key.

The "Back" item returns you to the Panel sub-menu.

"Cancel" or "Confirm" can be selected by using the "Step-up"/"Step-down" keys and then confirmed with the "Start/Stop - Enter" key.

Fig. 13.5.2.9-1: Sub-menu: Flashing when Faulty

```
-----
>off
Errors
warnings & errors
back
-----
cancel
confirm
```

13.5.2.10 Setting the Panel Heating

The menu item is selected by using the "Step-up"/"Step-down" keys confirmed with the "Start/Stop - Enter" key. The respective menu item opens.

"Off" or "On" can be selected by using the "Step-up"/"Step-down" keys and then confirmed with the "Start/Stop - Enter" key.

The "Back" item returns you to the Panel sub-menu.

"Cancel" or "Confirm" can be selected by using the "Step-up"/"Step-down" keys and then confirmed with the "Start/Stop - Enter" key.

Fig. 13.5.2.10-1: Sub-menu: Panel Heating

```
-----
>off
on
back
-----
cancel
confirm
```

13.5.2.11 Setting the display of the optional measurement data

The menu item is selected by using the "Step-up"/"Step-down" keys confirmed with the "Start/Stop - Enter" key. The respective menu item opens.

The desired optional measurement data is changed by using the "Step-up"/"Step-down" keys and the setting is confirmed with the "Start/Stop - Enter" key.

The desired option is selected by using the "Step-up"/"Step-down" keys and the setting is confirmed with the "Start/Stop - Enter" key.

The "Back" item returns you to the Panel sub-menu.

"Cancel" or "Confirm" can be selected by using the "Step-up"/"Step-down" keys and then confirmed with the "Start/Stop - Enter" key.

Fig. 13.5.2.11-1: Sub-menu: Optional Measurement Data

```

-----
extra phase-data
AGT-data
fuel-level
3 phases
oil-/air-pressure
back

cancel
confirm
  
```

13.5.2.12 Resetting all values of the Panel sub-menu to default values

The menu item is selected by using the "Step-up"/"Step-down" keys confirmed with the "Start/Stop - Enter" key. The respective menu item opens.

"Cancel" or "Confirm" can be selected by using the "Step-up"/"Step-down" keys and then confirmed with the "Start/Stop - Enter" key.

Fig. 13.5.2.12-1: Resetting all values

```

cancel
confirm
  
```

13.5.2.13 Return to Main Menu

The menu item is selected by using the "Step-up"/"Step-down" keys confirmed with the "Start/Stop - Enter" key. The respective menu item opens.

13.5.3 Sub-menu: "Generator"

The following items can be selected in the Generator sub-menu:

1. Autostart
 - configuring the Autostart function
2. Optional DC Output
 - setting the optional DC output
3. Switch Outputs
 - manual switching of the individual digital outputs
4. Event Memory
 - displaying the event memory
5. Display System Devices
 - displaying the detected system devices
6. Reset to standard
 - all parameters of the "Generator" sub-menu are reset to

Fig. 13.5.3-1: Generator Sub-Menu

```

autostart
opt. DC-output
switch outputs
event-log
show system-devices
reset to standard
back
  
```

the factory settings

7. Back

- Switching from the "Generator" sub-menu to the Main Menu

13.5.3.1 Setting the Autostart of the CP-G

The menu item is selected by using the "Step-up"/"Step-down" keys confirmed with the "Start/Stop - Enter" key. The respective menu item opens.

A choice can be made between "Switch on/off" and "Number of start-up attempts" in in the "Autostart" sub-menu.

Fig. 13.5.3.1-1: Autostart

```
-----
turn on / off
amount of restarts
back
-----
```

Switching On / Off

"Off" for deactivated or "On" for activated can be selected by using the "Step-up"/"Step-down" keys and then confirmed with the "Start/Stop - Enter" key.

Fig. 13.5.3.1-2: Autostart

```
-----
>off
on
back
-----
```

"Cancel" or "Confirm" can be selected by using the "Step-up"/"Step-down" keys and then confirmed with the "Start/Stop - Enter" key.

```
-----
cancel
confirm
-----
```

Number of start-up attempts

The value is changed by using the "Step-up"/"Step-down" keys and the setting is confirmed with the "Start/Stop - Enter" key.

Fig. 13.5.3.1-3: Autostart

```
-----
minimum value      1
autorestarts      1
maximum value      5
-----
```

"Cancel" or "Confirm" can be selected by using the "Step-up"/"Step-down" keys and then confirmed with the "Start/Stop - Enter" key.

```
-----
cancel
confirm
-----
```

For safety reasons, the number of start-up attempts is limited to one in the case of marine (PMS) generators.

Deadly danger! - The generator can be equipped with an Autostart function. This means that the generator is started by an external signal. In order to prevent an inadvertent start-up, the starter battery must be disconnected before work on the generator may commence.

Warning! Automatic start-up



The "Autostart" also remains active if the xControl CP-G is switched off and then on again.

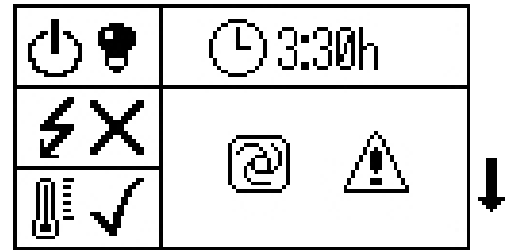
If a fault should arise when the generator is started or is already operating, it is stopped and the Autostart is set to "off".

If the generator is operated by Autostart and is stopped manually, the Autostart is set to "off".

Once the system has been switched off and then on again, the Autostart is active once more.

The first overview page shows if the Autostart is active.

Fig. 13.5.3-4: Overview Page 1 with Autostart



13.5.3.2 Setting the optional DC output of the CP-G

The menu item is selected by using the "Step-up"/"Step-down" keys confirmed with the "Start/Stop - Enter" key. The respective menu item opens.

"Operating Mode" or "Follow-up Time" can be selected by using the "Step-up"/"Step-down" keys and then confirmed with the "Start/Stop - Enter" key.

The "Back" item returns you to the "Generator" sub-menu.

Select cancel or confirm by using the "Step-up"/"Step-down" keys and then confirm with the "Start/Stop - Enter" key.

Setting the "Operating Mode" for the opt. DC Output (DP) of the CP-G

An option can be selected by using the "Step-up"/"Step-down" keys and the setting is confirmed with the "Start/Stop - Enter" key.

"Cancel" or "Confirm" can be selected by using the "Step-up"/"Step-down" keys and then confirmed with the "Start/Stop - Enter" key.

Setting the follow-up time of the optional DP Output of the CP-G

The value is changed by using the "Step-up"/"Step-down" keys and the setting is confirmed with the "Start/Stop - Enter" key.

"Cancel" or "Confirm" can be selected by using the "Step-up"/"Step-down" keys and then confirmed with the "Start/Stop - Enter" key.

13.5.3.3 Switching the switching outputs of the CP-G

The menu item is selected by using the "Step-up"/"Step-down" keys confirmed with the "Start/Stop - Enter" key. The respective menu item opens.

Fig. 13.5.3.2-1: Sub-menu: Optional DC Output

```
-----
operating mode
follow-up time
back
```

Fig. 13.5.3.2-2: Sub-menu: Operating Mode

```
off
always on
gen run
gen run & overrun
>depending on temp.
back
-----
```

```
cancel
confirm
```

Fig. 13.5.3.2-3: Sub-menu: Follow-up Time

```
minimum value    0.1s
time              0.0s
maximum value    60.0s
```

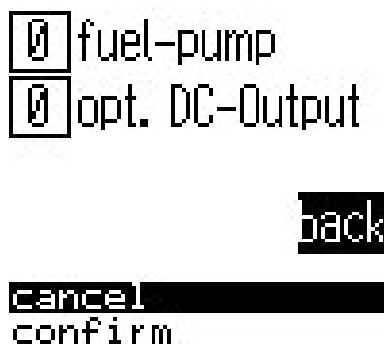
```
cancel
confirm
```

Select the "Fuel Pump" or "Opt. DC Outputs" by using the "Step-up"/"Step-down" keys and then confirm with the "Start/Stop - Enter" key.

The "Back" item returns you to the "Generator" sub-menu.

The value of the output can be set to "0" for deactivated or "1" for activated by using the "Step-up"/"Step-down" keys. Confirm with the "Start/Stop - Enter" key.

Fig. 13.5.3.3-1: Sub-menu: Switching Outputs



13.5.3.4 Reading out the Event Log of the CP-G

The menu item is selected by using the "Step-up"/"Step-down" keys and confirmed with the "Start/Stop - Enter" key. The respective menu item opens.

See "Table of Faults" on page 138. See "Description of the symbols" on page 140.

Fig. 13.5.3.4-1: Event Memory



One can scroll through the event memory by using the "Step-up"/"Step-down" keys and then return to the Generator menu with the "Start/Stop - Enter" key.

13.5.3.5 Resetting all values of the Generator sub-menu to the default values

The menu item is selected by using the "Step-up"/"Step-down" keys confirmed with the "Start/Stop - Enter" key. The respective menu item opens.

"Cancel" or "Confirm" can be selected by using the "Step-up"/"Step-down" keys and then confirmed with the "Start/Stop - Enter" key.

Fig. 13.5.3.5-1: Resetting all values



13.5.3.6 Returning the Main Menu

The menu item is selected by using the "Step-up"/"Step-down" keys confirmed with the "Start/Stop - Enter" key. The respective menu item opens.

13.5.4 Resetting the panel language to the default (English)

1. Press and hold the "Step down" key with the panel switched off.
2. Switch on the panel and hold down the "Step down" key until the first overview screen is displayed.
3. The panel language has now been reset. All other settings are retained.

13.5.4.1 How to set the panel language after a reset.

1. Switching on the xControl Panel CP-G
2. Wait until the first overview screen appears.
3. Scroll to the last overview screen.
4. Press the "Start/Stop - Enter" key to access the menu.
5. Scroll down to the "Panel" menu item.
6. Press the "Start/Stop - Enter" key to access the "Panel" sub-menu.
7. Scroll down to the "Choose language" menu item.
8. Press the Start/Stop - Enter key to access the "Language Selection" sub-menu.
9. Scroll to the desired language and confirm with the "Start/Stop - Enter" key.
10. Scroll down to the "Confirm" menu item and press the "Start/Stop - Enter" key.

The menu text is now set to the selected language.

13.6 Faults








13.6.1 Symbols and messages on the display

13.6.1.1 Example of message - "Sensor defective"

As soon as a defective sensor is detected, the xControl reports this on the display.



Fig. 13.6.1.1-1: Sensor defective







		26°C	✓
		---°C	
		25°C	✓

13.6.1.2 Example of message - "Sensor/Cable break"

If the sensor has failed or the cable is broken, the following report is displayed:



Fig. 13.6.1.2-1: Sensor/Cable break

		24°C	✓
		---°C	X
		23°C	✓

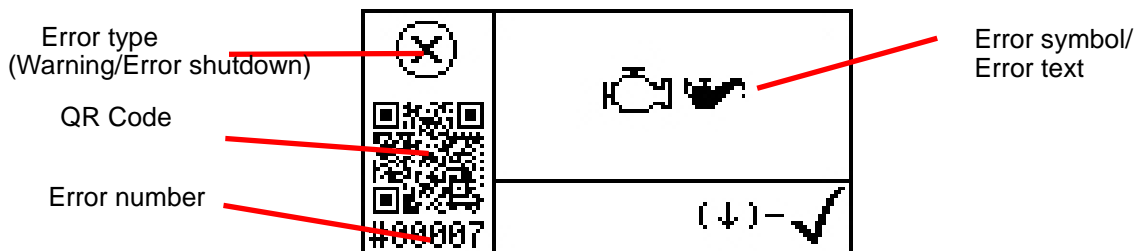
13.6.2 Error code

An error code is displayed if a parameter lies beyond its operating limits.

See "Table of Faults" on page 138. See "Description of the symbols" on page 140.

Example: Error No. 7 - Oil pressure too low -Fault led to emergency shutdown

Fig. 13.6.2.0-1: Sub-menu: "Event Log"



13.6.2.1 Table of Faults

See also the "Faults" chapter in the manual of the generator.













Fig. 13.6-1: Table of faults

No.	Description	Cause	Explanation	Warning	Gen.Stop	Info
1	AC Voltage	Voltage too low		yes	yes	n.a.
2	AC Frequency	Frequency too low		yes	yes	n.a.
5	Emergency	Emergency button pushed	"Emergency" contact open	n.a.	yes	n.a.
7	Oil pressure	Oil pressure too low	Failure oil pressure switch	n.a.	yes	n.a.
13	Starter power	Starter failure	Short circuit starter defect	yes	n.a.	n.a.
14	Glow circuit	Glow circuit failure	Short circuit defect	yes	n.a.	n.a.
16	Fuel supply	Failure fuel supply	Short circuit defect	yes	n.a.	n.a.
17	Stop solenoid - Hold	Failure stop solenoid hold coil	Short circuit	yes	n.a.	n.a.
18	Stop solenoid - Pull	Failure stop solenoid pull coil	Short circuit	yes	n.a.	n.a.
19	Optional DC out	Failure optional DC out	Short circuit	yes	n.a.	n.a.
20	Current sensor	No voltage on supply current sensor	Short circuit defect		yes	
25	Battery voltage	Battery voltage too low		yes	yes	
26	RPM failure	RPM out of range	Failure fuel supply Fuel empty	n.a.	yes	
29	Power out relay	Failure power out relay	Short circuit	n.a.	n.a.	
30	AC Voltage L2	Voltage too low L2		yes	yes	
31	AC Frequency L2	Frequency too low L2		yes	yes	
34	AC Voltage L3	Voltage too low L3		yes	yes	
35	AC Frequency L3	Frequency too low L3		yes	yes	
63	Fuel level	Fuel level to low		yes	no	
65	AC Voltage	Voltage too high		yes	yes	
66	AC Frequency	Frequency to high		yes	yes	
67	AC Current	Current too high		yes	n.a.	
68	AC Power	Load too high		yes	n.a.	
70	Servo Power	Power too high	Mechanically blocked. Power consumption too high, short circuit	yes	yes	
72	Temperature Cylinder head	Temp. value too high		yes	yes	
73	Temperature Winding	Temp. value too high		yes	yes	
74	Temperature Exhaust	Temp. value too high		yes	yes	
75	Temperature Electronics	Temp. value too high		yes	n.a.	
77	Starter power	Starter failure	Short circuit starter defect	yes	n.a.	
78	Glow circuit	Glow circuit failure	Short circuit defect	yes	n.a.	
80	Fuel supply	Failure fuel supply	Short circuit defect	yes	n.a.	
81	Stop solenoid - Hold	Failure stop solenoid hold coil	Short circuit	yes	n.a.	

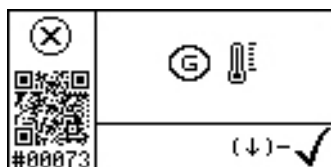
No.	Description	Cause	Explanation	Warning	Gen.Stop	Info
82	Stop solenoid - Pull	Failure stop solenoid pull coil	Short circuit	yes	n.a.	
83	Optional DC out	Failure optional DC out	Short circuit	yes	n.a.	
84	Power Supply	Current Sensor Current too high	Short circuit defect	yes	yes	
85	Boost Relay	Failure Boost relay	short circuit or too many modules	yes	yes	
86	Bus Power	Bus Power Consumption high	Short circuit	yes	no	
89	Battery voltage	Battery voltage too high		yes	yes	
93	Power out relay	Failure power out relay	Short circuit or defect	yes	yes	
94	AC Voltage L2	Voltage too high L2		yes	yes	
95	AC Frequency L2	Frequency too high L2		yes	yes	
96	AC Current L2	Current too high L2		yes	n.a.	
97	AC Power L2	Power too high L2		yes	n.a.	
98	AC Voltage L3	Voltage too high L3		yes	yes	
99	AC Frequency L3	Frequency too high L3		yes	yes	
100	AC Current L3	Current too high L3		yes	n.a.	
101	AC Power L3	Power too high L3		yes	n.a.	
126	Temperature Fuel	Fuel Temperature too high		yes	n.a.	
130	No Panel found	Wrong patch cable/wrong contact	check cable/harness	n.a.	yes	n.a.
131	Communication FP BUS	Communication failure	lost communication with Panel	n.a.	yes	
132	Service interval	Service due		yes	n.a.	
133	BUS Module lost (3ph-measurement)			yes	n.a.	
134	BUS Module lost (DC-measurement)			n.a.	yes	
135	Sync failure	generators cannot be synced	second generator cannot be switched to the running generator		yes	
136	Communication motor controller	No data from motor controller	Short circuit defect		yes	
137	Air filter	Error Air filter	Bad air filter		yes	
139	Sync module	No data from sync module	Short circuit defect		yes	
140	load balancing	Generator takes less load	Generator produces insufficient power		yes	
141	Configuration sync module	Sync module available but not selected	Crippled mode only		no	
246	Service done	user	Service interval reset	n.a.	n.a.	yes
251	Admin Param changed	user	Parameter changed at Admin level	n.a.	n.a.	yes
255	Reserved			n.a.	n.a.	yes

13.6.2.2 Description of the symbols

Fig. 13.6-1: Description of the symbols

Symbol	Description		Symbol	Description	
	WARNING			Current	Generator output
	Error shutdown			Frequency	Generator output
	Faults	No contact		Voltage	Generator output
	Broken	Short circuit		(%)/Load	
	OK			Generator runs	
	AC Voltage			Generator off	
	Run-up phase/Over-ride	Generator start-up		Temperature	
	Standby			Engine	
	Automatic start-up.			Exhaust system	
	Starter battery			Winding	
	Operating hours			Preheating	
	Oil pressure			Speed/RPM	
	Self test			Tank gauge %	
	Apparent power			Starter turns	

Example:



Error73: Error shutdown due to winding temperature

13.7 Accessories:

FP Bus Cable (15 m): 34.02.02.131H

Fig. 13.7-1: FP Bus Cable (15 m): 34.02.02.131H



Terminating resistor:34.02.02.133H

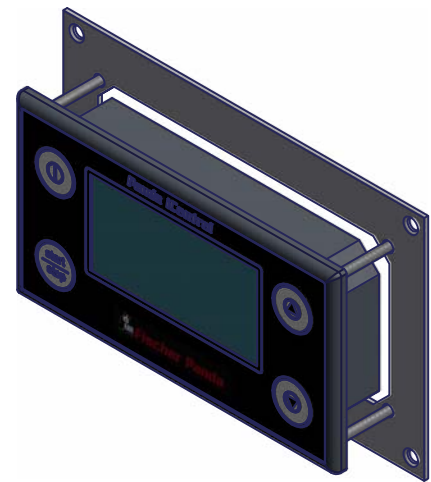
Fig. 13.7-2: Terminating resistor:34.02.02.133H



Adapter Frame: 31.03.20.263H

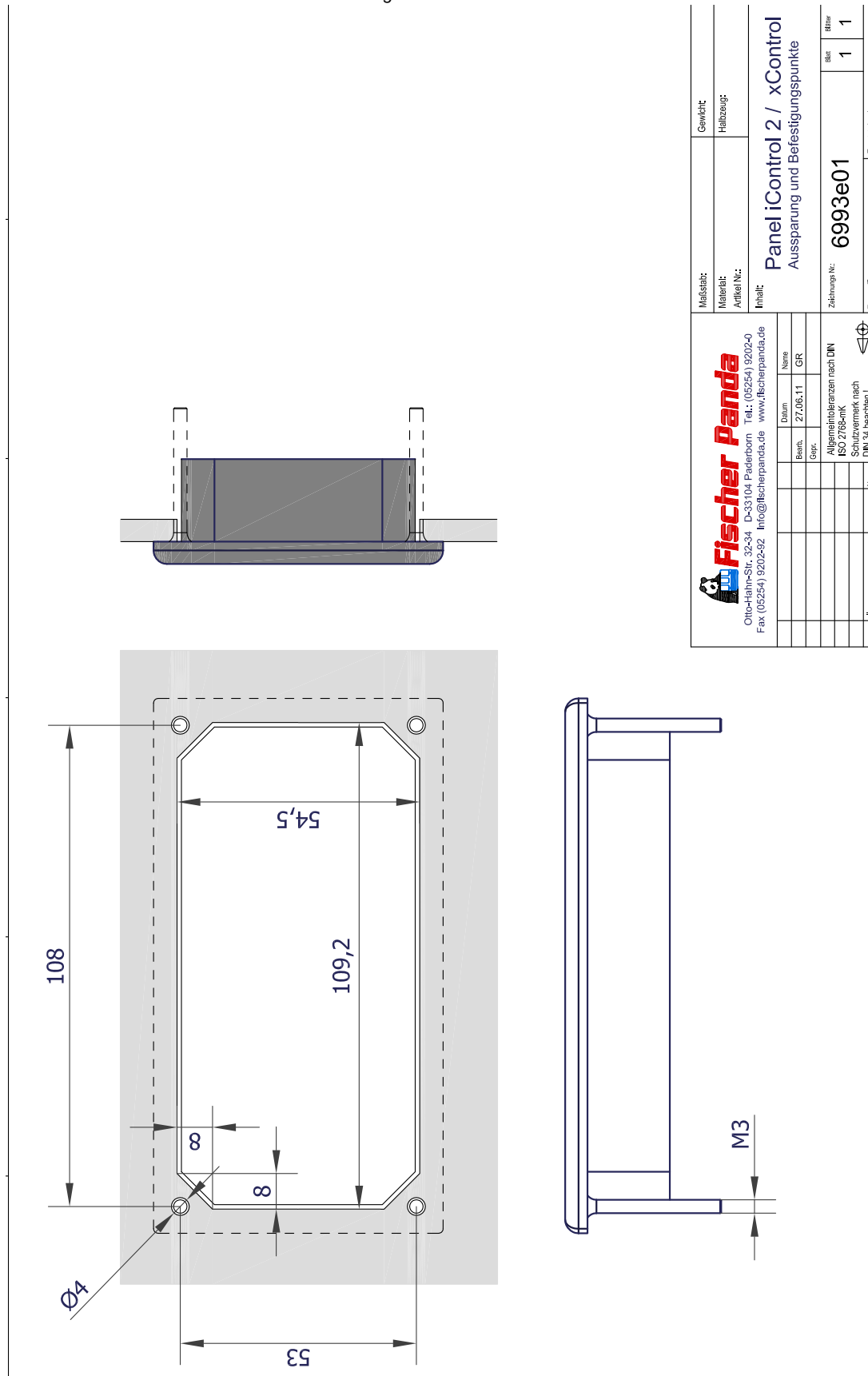
Fig. 13.7-3: Adapter Frame: 31.03.20.263H


xContol CP-G in a Generator Control (P6+) section



13.7.1 Dimensional drawing

Fig. 13.7.1-1: CP-G



 Fischer Panda Otto-Hahn-Str. 32-34 D-33104 Paderborn Tel.: (05254) 9202-0 Fax (05254) 9202-92 Info@fischerpanda.de www.fischerpanda.de		Maßstab: Material: Artikel Nr.: Inhalt:	Gewicht: Halbzeug:
Bearb. Datum: 27.06.11 Entw. Name: GR	Name:	Panel iControl 2 / xControl Ausstattung und Befestigungspunkte	
Allgemeine Toleranzen nach DIN ISO 2768-mK Schutzmerk nach DIN 34 beachten!	Zeichnungs Nr.: Blatt:	6993e01 1	Blatt:
Ziel:	Anmerkungen:	Ersatz durch:	1