



# Fischer Panda®

Power  
wherever  
you are™



## Vehicles Generator Manual

Panda 8000x PVMV-N 8 kVA

Panda 10000x PVMV-N 10k VA

230 V - 50 Hz

400 V - 50 Hz

Super silent technology

Panda\_8000x-10000x\_PVMV-N\_eng.R01.1

10.6.16



## Current revision status

	Document
Actual:	Panda_8000x-10000x_PVMV-N_eng.R01.1.10.6.16
Replace:	Panda_8000x-10000x_PVMV-N_eng.R01

Revision	Page
DC Installation überarbeitet	

### Erstellt durch / created by

Fischer Panda GmbH - Leiter Technische Dokumentation

Otto-Hahn-Str. 32-34

33104 Paderborn - Germany

Tel.: +49 (0) 5254-9202-0

email: [info@fischerpanda.de](mailto:info@fischerpanda.de)

web: [www.fischerpanda.de](http://www.fischerpanda.de)

### Copyright

**Duplication and change of the manual is permitted only in consultation with the manufacturer!**

Fischer Panda GmbH, 33104 Paderborn, reserves all rights regarding text and graphics. Details are given to the best of our knowledge. No liability is accepted for correctness. Technical modifications for improving the product without previous notice may be undertaken without notice. Before installation, it must be ensured that the pictures, diagrams and related material are applicable to the genset supplied. Enquiries must be made in case of doubt.



**Fischer Panda GmbH**  
 Otto-Hahn-Str. 40  
 D-33104 Paderborn  
 Germany

Tel. : +49 (0)5254 9202-0  
 Fax. : +49 (0)5254 9202-550  
 Hotline : +49 (0)5254 9202-767  
 Email : [info@fischerpanda.de](mailto:info@fischerpanda.de)  
 Web : [www.fischerpanda.de](http://www.fischerpanda.de)



# Inhalt / Contents

<b>Current revision status</b> .....	<b>2</b>
<b>1 General Instructions and Regulations</b> .....	<b>12</b>
1.1 Safety first!.....	12
1.2 Tools .....	14
1.3 Manufacturer declaration in accordance with the Machinery Directive 2006/42/EC .....	16
1.4 Customer registration and guarantee .....	16
1.4.1 Technical support .....	16
1.4.2 Caution, important information for start-up! .....	16
1.5 Safety Instructions - Safety First! .....	17
1.5.1 Safe operation .....	17
1.5.2 Observe safety instructions! .....	17
1.5.3 Personal protective clothing (PPE) .....	17
1.5.4 Cleanliness ensures safety .....	17
1.5.5 Safe handling of fuels and lubricants .....	18
1.5.6 Exhaust fumes and fire protection .....	18
1.5.7 Safety precautions against burns and battery explosions .....	19
1.5.8 Protect your hands and body from rotating parts! .....	19
1.5.9 Anti-freeze and disposal of fluids .....	19
1.5.10 Implementation of safety inspections and maintenance .....	20
1.6 Warning and instruction signs.....	20
1.6.1 Special instructions and hazards of generators .....	20
1.6.1.1 Protective conductor and potential equalisation:.....	21
1.6.1.2 Protective conductor for Panda AC generators:.....	21
1.6.1.3 Switch off all loads while working on the generator .....	21
1.6.1.4 Potential equalisation for Panda AGT DC generators.....	21
1.6.1.5 Safety instructions concerning cables.....	22
1.6.2 General safety instructions for handling batteries .....	22
<b>2 In case of Emergency First Aid / Im Notfall - Erste Hilfe</b> .....	<b>23</b>
2.7 WHEN AN ADULT STOPS BREATHING .....	24
<b>3 Basics</b> .....	<b>25</b>
3.1 Intended use of the machine .....	25
3.2 Purpose of the manual and description of the definitions of the trained persons/operators/users . ....	25
3.2.1 Trained persons .....	25
3.2.2 Operator/Owner .....	25
3.2.3 User .....	26
3.3 Components of the xGenerator .....	26
3.4 Range of operation .....	28
3.5 Panda transport box .....	28
3.5.1 Bolted Fischer Panda transport box .....	28
3.5.2 Fischer Panda transport box with metal tab closure .....	28
3.6 Opening the MPL sound insulation capsule .....	29
3.6.1 Opening the GFK sound insulation capsule .....	30
3.7 Transport and loading/unloading .....	30
3.7.1 Transporting the generator .....	30
3.7.2 Loading/unloading of the generator .....	30
3.8 Special service instructions and measures for extended machine downtimes and decommissioning	31



## Inhalt / Contents

3.8.1	Instructions for the starter battery for extended downtimes .....	31
3.8.2	Measures for short downtimes .....	32
3.8.3	Measures for medium term downtimes / hibernation .....	32
3.8.3.1	Courses for preservation: .....	32
3.8.3.2	Measures for removing surface protection after medium term downtimes (3 to 6 months). 33	
3.8.4	Measures for extended downtimes / decommissioning .....	33
3.8.4.1	Courses for preservation: .....	33
3.8.4.2	Measures for removing surface protection after extended downtimes / recommissioning (over 6 months): 34	
<b>4</b>	<b>The Panda Generator .....</b>	<b>35</b>
4.1	Type plate at the Generator .....	35
4.2	Description of the Generator .....	36
4.2.1	Right Side View .....	36
4.2.2	Left Side View .....	37
4.2.3	Front View .....	38
4.2.4	Back View .....	39
4.3	Details of functional units .....	40
4.3.1	xControl panel .....	40
4.3.2	The cooling system .....	41
4.3.3	The fuel and combustion air system .....	42
4.3.4	Components of electrical system .....	43
4.3.5	Sensors and switches for operating surveillance .....	43
4.3.6	The oil circuit - Schema .....	45
<b>5</b>	<b>Installation Instructions .....</b>	<b>47</b>
5.1	Personal requirements .....	47
5.1.1	Hazard notes for the installation .....	47
5.2	Environmental protection .....	49
5.3	Placement .....	50
5.3.1	General instructions .....	50
5.3.2	Preparing the base - Placement .....	50
5.3.3	Advice for optimal sound insulation .....	50
5.4	Air suction filter as a source of noise .....	52
5.5	Generator Connections .....	52
5.6	Fuel system installation .....	52
5.6.0.1	The following items need to be installed: .....	52
5.6.1	Connection of the fuel lines at the tank .....	54
5.6.2	Position of the pre-filter with water separator .....	54
5.7	Ventilating the Fuel System .....	55
5.8	Installation of the cooling system .....	55
5.8.1	The cooling system / general instructions .....	55
5.9	Radiator baseplate .....	55
5.9.1	Determining the size of the radiator .....	56
5.9.2	Radiator design .....	56
5.9.3	Radiator types .....	56
5.9.3.1	Installation location for radiators for roof, side, or underfloor mounting on the vehicle 57	
5.9.3.2	Roof installation .....	57

## Inhalt / Contents

5.9.3.3	Installation on the vehicle wall.....	59
5.9.3.4	Underfloor installation of radiator .....	60
5.9.3.5	Installation location for radiator in the vehicle wall or cabin wall .....	61
5.9.3.6	Installation location for radiator in a tunnel.....	62
5.9.3.7	Installation location for generators of the PVK-UK series .....	63
5.9.4	Coolant hoses .....	63
5.9.5	Connection of the external radiator .....	63
5.9.6	Coolant expansion tank .....	64
5.9.7	Installation of a coolant temperature indicator .....	64
5.9.8	Permissible coolant temperatures .....	64
5.9.9	Coolant pump .....	64
5.9.10	Radiator fan .....	65
5.9.11	Anti-freeze and corrosion protection .....	65
5.9.12	Logging the temperature values during initial start-up .....	65
5.10	Custom installations.....	66
5.10.1	External heat exchangers .....	66
5.10.2	External engine pre-heater .....	66
5.10.3	Keel cooling .....	66
5.11	Installation schematics .....	67
5.11.1	Installation for vertical radiator installation .....	67
5.11.2	Installation for mounting the radiator under the vehicle .....	68
5.11.3	Installation schematic for roof mounted radiator with expansion tank .....	69
5.11.4	Installation Radiator with Intercooler -Schematic sample vertical Radiator .....	69
5.12	Exhaust installation.....	70
5.12.1	Exhaust connection for roof outlet .....	70
5.12.2	Exhaust connection for mounting below the vehicle .....	70
5.13	Connection of the Electrical Components.....	71
5.14	Generator AC System Installation .....	72
5.15	AC-Control box .....	72
5.15.1	Installation with looped-in AC-Control box .....	75
5.15.2	Installation AC-Box / Distribution panel connected separately .....	75
5.15.3	Electronic voltage control xControl .....	76
5.15.4	Connection to the AC on-board power supply .....	76
5.15.4.1	Protective conductor .....	76
5.15.4.2	Electrical fuse.....	76
5.15.4.3	Required cable crosssections .....	76
5.16	Generator DC system installation .....	76
5.16.1	Connection of the starter battery block .....	77
5.16.2	Connection of the remote control panel - see separate control panel manual .....	79
5.16.3	Connection Box – Generator xControl – CB-G .....	79
5.16.3.1	xControl ECU .....	79
5.16.3.2	FP CAN-Bus for internal use.....	80
5.16.3.3	Boostrelay (optional) .....	80
5.16.3.4	Line Relay (optional) .....	80
5.16.3.5	Autostart (optional).....	80
5.16.3.6	Emergency Stop (optional).....	80
5.16.3.7	Fuel pump .....	80
5.16.3.8	Optional DC-OUT.....	80
5.16.3.9	FP CAN-Bus RJ45 .....	80
5.17	Radiator fan control / electronic fan control .....	80
5.18	Standard fan control for 1-phase and 3-phase generators.....	81



## Inhalt / Contents

5.19	Electronic fan control for DC fans RE 0201 .....	83
5.20	Brief description .....	83
5.20.1	Function .....	83
5.20.2	Master - Slave - Operation .....	84
5.20.3	Function of the clamps for the Master-Slave-Operation .....	85
5.20.4	Remote controlled switching on and off of the fan controller .....	85
5.20.5	12 V / 24 V - Operation .....	85
5.21	Technical Data .....	86
5.22	Electronic fan control for single phase fans PKE-2.5V_Ziehl Abegg .....	88
5.22.1	Preset for the use with Fischer Panda generators .....	88
5.22.2	Connection of the sensor (Ziehl Abegg KTY) .....	89
5.23	Electronic fan control for single phase fans PXET6Q_Ziehl Abegg .....	90
5.23.1	Preset for the use with Fischer Panda generators .....	90
5.23.2	Connection of the sensor (Ziehl Abegg KTY) .....	91
5.24	Electronic fan control for 3 phase fans PKD T5/PKD M10 Ziehl Abegg.....	92
5.24.1	Configuration of the electronic fan control PKD T5 for Fischer Panda Generators .....	93
5.25	Configuration of the electronic fan control PKD M10 for Fischer Panda Generators.....	94
5.26	Insulation test .....	95
5.27	Set into operation.....	95
<b>6</b>	<b>Generator operation instruction .....</b>	<b>97</b>
6.1	Personal requirements.....	97
6.2	Hazard notes for the operation .....	97
6.3	General operating instruction.....	97
6.3.1	Operation at low temperatures .....	97
6.3.1.1	Pre-heating the diesel motor .....	98
6.3.1.2	Tips regarding starter battery .....	98
6.3.2	Light load operation and engine idle .....	98
6.3.2.1	The soot of the generator is due to the fact that:.....	98
6.3.2.2	To prevent the soot of the generator following steps should be observed: .....	98
6.3.3	Generator load for a longer period and overload .....	98
6.3.4	Protection conductor: .....	99
6.3.5	Operating control system on the Fischer Panda generator .....	99
6.4	Instructions for capacitors - not present at all models.....	99
6.5	Checks before start, starting and stopping the generator.....	99
6.6	Instructions for capacitors - not present at all models.....	100
<b>7</b>	<b>Maintenance Instructions .....</b>	<b>101</b>
7.1	Personal requirements.....	101
7.2	Hazard notes for the maintenance and failure .....	101
7.3	Environmental protection .....	103
7.4	Maintenance Requirements .....	103
7.5	Maintenance interval.....	103
7.6	De-aerating of the coolant circuit .....	103
7.7	Replacing the air filter .....	106
7.8	Checking oil-level .....	107
7.8.1	Refilling oil .....	108

## Inhalt / Contents

7.8.2	After the oil level check and refilling the oil .....	108
7.9	Replacement of engine oil and engine oil filter .....	109
7.9.1	After the oil change .....	111
7.10	Verifying the starter battery and (if necessary) the battery bank .....	112
7.10.1	Battery .....	112
7.10.1.1	Check battery and cable connections .....	112
7.10.1.2	Check electrolyte level .....	112
7.10.1.3	Check electrolyte density .....	113
<b>8</b>	<b>Generator Failure .....</b>	<b>115</b>
8.1	Personal requirements.....	115
8.2	Hazard notes for the troubleshooting.....	115
8.3	Tools and measuring instruments .....	117
8.4	Overloading the Generator .....	117
8.4.1	Effects of Short Circuiting and Overloading on the Generator .....	117
8.4.2	Overloading the Generator with Electric Motors .....	117
8.4.3	Generator Voltage Fluctuations and Monitoring .....	118
8.4.4	Automatic Voltage Monitoring and Auto-Shut Down .....	118
8.5	Low Generator-Output Voltage.....	118
8.5.1	Discharge the capacitors .....	118
8.5.2	Checking the Capacitors .....	119
8.6	Testing generator stator windings .....	121
8.6.1	Checking the generator voltage .....	121
8.6.2	Measuring the coil resistance .....	121
8.6.3	Checking the coil(s) to short-circuit .....	121
8.6.4	Measuring the inductive resistance .....	122
8.6.5	Testing generator stator winding for „shorts“ to ground .....	122
8.6.6	Coil Resistance Measurements in Stator Windings .....	128
8.6.6.1	Checking windings .....	128
8.7	Measuring the Coil Inductive Resistance.....	129
8.8	Generator provides no Voltage.....	129
8.8.1	Rotor Magnetism Loss and „Re-magnetizing“ .....	129
8.8.2	Stop solenoid .....	130
8.8.3	Damage to starter motor .....	131
8.9	Troubleshooting Table .....	132
8.9.1	Generator faults .....	132
8.9.1.1	Generator output to low. For 50 Hz versions: less than 200 V. For 60 Hz versions: less than 100 V. 132	
8.9.1.2	Generator voltage to high (more then 240 V-50 Hz / 135 V-60 Hz). If the generator is providing excessively high voltage, the following potential causes should be investigated: 132	
8.9.1.3	Generator voltage fluctuates. ....	132
8.9.1.4	Generator is not able to start a electric motor. ....	132
8.9.1.5	Diesel motor fails to start.....	132
8.9.1.6	Starter motor is turning the engine, but generator fails to start. ....	133
8.9.1.7	Motor does not achieves enough speed during starting process. ....	133
8.9.1.8	Motor runs irregular.....	133
8.9.1.9	Motor speed drops. ....	133
8.9.1.10	Motor runs in off position. ....	134
8.9.1.11	Motor stops by itself. ....	134
8.9.1.12	Sooty black exhaust. ....	134

## Inhalt / Contents

8.9.1.13	Generator must be shut off immediately if:.....	134
<b>9</b>	<b>Appendix.....</b>	<b>135</b>
9.1	Engine oil.....	135
9.1.1	Engine oil classification.....	135
9.1.1.1	Operating range:.....	135
9.1.1.2	Quality of oil:.....	135
9.2	Coolant specifications.....	136
9.2.1	Coolant mixture ratio.....	136
9.3	Fuel.....	136
9.4	Technical data coil.....	137
9.5	Diameter of conduits vehicle generators.....	138
9.6	Rated current.....	141
9.7	Cable cross-section.....	141
9.8	Technical data.....	141
	<b>Current revision status.....</b>	<b>150</b>
<b>10</b>	<b>Safety Instructions Panda xControl.....</b>	<b>151</b>
10.1	Personal requirements.....	151
10.2	Safety instructions.....	151
<b>11</b>	<b>Panda xControl.....</b>	<b>153</b>
11	Components of the xControl.....	153
11.0.1	xControl – CP-G.....	153
11.0.2	xControl – GC-S.....	153
11.0.3	xControl - CB-G.....	154
11.0.3-1	Installation.....	154
11.0.4	Installation of the Electronic Control Unit (ECU) xControl - GC-S.....	154
11.0.5	Installation of the Connection Box xControl - CB-G.....	154
11.0.6	Installation of the xControl - CP-G.....	154
11.0-2	Operation.....	155
11.0.7	Switching on the generator.....	156
11.0.7.1	Overview screen with activated autostart.....	157
11.0.8	The Overview Screens.....	159
11.0.9	Overview Screens Symbolic.....	159
11.0.10	Overview Screens English Text.....	160
11.0.11	Overview Screens German Text.....	161
11.1	Start of the Generator.....	163
11.1.1	Marine version starting preparation / Checks (daily).....	163
11.1.2	Vehicle version starting preparation / Checks (daily).....	163
11.1.3	Starting the generator.....	164
11.1.4	Stopping the generator.....	165
<b>3</b>	<b>The Menu.....</b>	<b>166</b>
11.1.5	Main Menu.....	167
11.1.6	Submenu „Panel“.....	168
11.1.7	Submenu „Generator“.....	168
11.1.7.1	Set up the brightness of the CP-G.....	168
11.1.7.2	Set up the contrast of the CP-G.....	169
11.1.7.3	Set up the standby time out of the CP-G.....	169



## Inhalt / Contents

11.1.7.4	Set up the standby brightness of the CP-G.....	170
11.1.7.5	Set up the way of illustration of the overview screens of the CP-G .....	170
11.1.7.6	Choose the language of the text screens of the CP-G.....	171
11.1.7.7	Set up temperature unit.....	171
11.1.7.8	Reset all values of the panel submenu to standard .....	172
11.1.7.9	Back to the main menu .....	172
11.1.8	Submenu „Generator“ .....	173
11.1.8.1	Set up the autostart of the CP-G.....	173
11.1.8.2	Set up the optional DC output of the CP-G .....	175
11.1.8.3	Set up the operation mode for the opt. DC-Power (DP) output of the CP-G....	176
11.1.8.4	Set up the follow-up time for the opt. DP output of the CP-G .....	176
11.1.8.5	Switch the outputs of the CP-G.....	176
11.1.8.6	Check the event log of the CP-G .....	177
11.1.8.7	Reset all values of the generator submenu to standard.....	177
11.1.8.8	Back to the main menu .....	178
11.1.9	How to change the menu text from german to english .....	178
11.2	Failure .....	179
11.2.1	Symbols and Messages in the Display .....	179
11.2.1.1	Message sample „Sensor defect“ .....	179
11.2.1.2	Message sample sensor/cable broken.....	179
11.2.1.3	Failure code .....	180
11.2.2	Failuretable .....	180
11.2.3	Description of Symbols .....	183
11.2-1Zubehör:	.....	185
11.2.3.1	Dimensionszeichnung .....	186
11.2.3-3.....	.....	188

Leere Seite / Intentionally blank

## **Dear Customer,**

Thank you for purchasing a Fischer Panda Generator and choosing Fischer Panda as your partner for mobile power on board. With your generator, you now have the means to produce your own power – wherever you are - and experience even greater independence. Not only do you have a Fischer Panda generator on board, you also have worldwide support from the Fischer Panda Team. Please take the time to read this and find how we can support you further.

### **Installation Approval and Warranty**

Every generator has a worldwide warranty. You can apply for this warranty through your dealer when the installation is approved. If you have purchased an extended warranty, please ensure that it is kept in a safe place and that the dealer has your current address. Consult your dealer about warranty options especially if you have purchased a used generator. He will be able to advise about authorised Fischer Panda Services worldwide.

### **Service and Support**

To ensure that your generator operates reliably, regular maintenance checks and tasks as specified in this manual must be carried out. Fischer Panda can supply Service Kits which are ideal for regular servicing tasks. We only supply the highest quality components which are guaranteed to be the RIGHT parts for your generator. Service “Plus” Kits are also available and ideal for longer trips where more than one service interval may be required.

If you require assistance – please contact your Fischer Panda Dealer. Please do not attempt to undertake any repair work yourself, as this may affect your generator warranty. Your dealer will also be able to assist in finding your nearest Fischer Panda service station. Your nearest service station can also be found in our Global Service Network which can be downloaded from our homepage.

### **Product Registration**

Please take the time to register your Fischer Panda Generator on our website at

<http://www.fischerpanda.de/mypanda>

By registering, you will ensure that you will be kept up to date on any technical upgrades or specific information on the operation or servicing of your generator. We can even let you know about new Fischer Panda products – especially helpful if you are planning to upgrade or expand your installation at a later date.

### **Fischer Panda Quality - Tried and Tested**

DIN-certified according DIN ISO 9001

**Thank you for purchasing a Fischer Panda Generator.**

**Your Fischer Panda Team**

# 1. General Instructions and Regulations

## 1.1 Safety first!

---

These symbols are used throughout this manual and on labels on the machine itself to warn of the possibility of personal injury or lethal danger during certain maintenance work or operations. Read these instructions carefully.

Can cause acute or chronic health impairments or death even in very small quantities if inhaled, swallowed, or absorbed through the skin.

**WARNING: Hazardous materials**



This warning symbol draws attention to special warnings, instructions or procedures which, if not strictly observed, may result in damage or destruction of equipment.

**WARNING: Important information!**



Warning of materials that may ignite in the presence of an ignition source (cigarettes, hot surfaces, sparks, etc.).

**WARNING: Fire hazard**



In the environment described / during the work specified, smoking is prohibited.

**PROHIBITED: No smoking**



Fire and naked light are ignition sources that must be avoided.

**PROHIBITED: No fire or naked light**



The equipment shall not be activated or started up while work is in progress.

**PROHIBITED: Do not activate/start up**



Touching of the corresponding parts and systems is prohibited.

**PROHIBITED: Do not touch**



**Danger for life! Working at a running generator can result in severe personal injury.**

**DANGER: Automatic start-up**



The generator can be equipped with a automatic start device. This means, an external signal may trigger an automatic start-up. To avoid an unexpected starting of the generator, the starter battery must be disconnected before working at the generator.

This danger symbol refers to the danger of electric shock and draws attention to special warnings, instructions or procedures which, if not strictly observed, may result in severe personal injury or loss of life due to electric shock.

**WARNING: Hazardous electric voltage**



General warning of a hazard area

**WARNING: General warning**



Can cause acute or chronic health impairments or death even in very small quantities if inhaled or ingested.

**WARNING: Danger due to inhalation and/or ingestion**



Warning of live parts that may cause electric shock upon contact. Especially dangerous for persons with heart problems or pacemakers.

**WARNING: Risk of electric shock upon contact**



Danger of injury due to being pulled into equipment. Bruising and torn off body parts possible. Risk of being pulled in when touching with body part, loose-fitting clothing, scarf, tie, etc.

**WARNING: Danger due to rotating parts**



Warning of substances that may cause an explosion under certain conditions, e.g. presence of heat or ignition sources.

**WARNING: Explosion hazard**



Warning of hot surfaces and liquids. Burn/scalding hazard.

**WARNING: Hot surface**



Warning of substances that cause chemical burns upon contact. These substances can act as contaminants if introduced into the body.

**WARNING: Danger due to corrosive substances, potential contamination of person**



When the system is opened, the pressure can be relieved abruptly and expel hot gases and fluids. Risk of injury due to parts flying about, burn hazard due to liquids and gases.

**WARNING: System may be pressurised!**



Warning of hearing damages.

**WARNING: Hearing damage**



Warning of magnetic field.

**WARNING: Magnetic field**



Warning of overpressure.

**WARNING: Overpressure**



Wearing the applicable snugly fitting protective clothing provides protection from hazards and can prevent damage to your health.

**MANDATORY INSTRUCTION: Wear snugly fitting protective clothing (PPE).**



Wearing hearing protection provides protection from acute and gradual hearing loss.

**MANDATORY INSTRUCTION: Wear hearing protection (PPE).**



Wearing safety goggles protects the eyes from damage. Optical spectacles are not a replacement for the corresponding safety goggles.

**MANDATORY INSTRUCTION: Wear safety goggles (PPE).**



Wearing protective gloves provides the hands from hazards like friction, graze, punctures or deep cuts and protects them from contact with hot surfaces.

**MANDATORY INSTRUCTION: Wear protective gloves (PPE).**



Compliance with the instructions in the manual can avert danger and prevent accidents. This will protect you and the generator.

**MANDATORY INSTRUCTION: Observe the instructions in the manual.**







Environmental protection saves our living environment. For you and for your children.





**MANDATORY INSTRUCTION: Comply with environmental protection requirements.**



## 1.2 Tools

These symbols are used throughout this manual to show which tool must be used for maintenance or installation.

	Spanners W.A.F X = width across flats of X mm
	Hook wrench for oil filter
	Screw driver, for slotted head screws and for Phillips head screws
	Multimeter, multimeter with capacitor measuring unit

	<p>Socket wrench set</p>
	<p>Hexagon socket wrench set</p>
	<p>Clamp-on ammeter (DC for synchronous generators; AC for asynchronous generators)</p>
	<p>Torque wrench</p>

### **1.3 Manufacturer declaration in accordance with the Machinery Directive 2006/42/EC**

---

---

Manufacturer declaration in accordance with the Machinery Directive 2006/42/EC

The generator was designed in such a way that all assemblies correspond with the CE guidelines. If Machinery Directive 2006/42/EC is applied, then it is forbidden to start the generator until it has been ascertained that the system into which the generator is to be integrated also complies with the Machinery Directive 2006/42/EC. This includes the exhaust system, cooling system and electrical installations.

The evaluation of "protection against contact" must be carried out when installed, in conjunction with the respective system. This also includes correct electrical connections, a safe ground wire connection, foreign body and humidity protection, protection against moisture due to excessive condensation, as well as overheating through appropriate and inappropriate use of the equipment in its installed state. The responsibility for implementing these measures lies with those who undertake the installation of the generator in the final system.

### **1.4 Customer registration and guarantee**

---

---

Use the advantages of registering your product:

- you will receive a Guarantee Certificate after approval of your installation data
- you will receive extended product information that may be relevant to safety.
- You will receive free upgrades as necessary.

Additional advantages:

Based on your complete data record, Fischer Panda technicians can provide you with fast assistance, since 90 % of the disturbances result from defects in the periphery.

Problems due to installation errors can be recognized in advance.

#### **1.4.1 Technical support**

---

Technical Support via the Internet: [info@fischerpanda.de](mailto:info@fischerpanda.de)

#### **1.4.2 Caution, important information for start-up!**

---

1. The commissioning log shall be filled in immediately after initial operation and shall be confirmed by signature.
2. The commissioning log must be received by Fischer Panda GmbH at Paderborn within 4 weeks of initial operation.
3. After receiving the commissioning log, Fischer Panda will make out the official guarantee certificate and send it to the customer.
4. If warranty claims are made, the document with the guarantee certification must be submitted.

If the above requirements are not or only partly fulfilled, the warranty claim shall become void.



## 1.5 Safety Instructions - Safety First!

---

### 1.5.1 Safe operation

---

Careful handling of the equipment is the best insurance against an accident. Read the manual diligently, and make sure you understand it before starting up the equipment. All operators, regardless of their experience level, shall read this manual and additional pertinent manuals before commissioning the equipment or installing an attachment. The owner shall be responsible for ensuring that all operators receive this information and are instructed on safe handling practices.



### 1.5.2 Observe safety instructions!

---

Read and understand this manual and the safety instructions on the generator before trying to start up and operate the generator. Learn the operating practices and ensure work safety. Familiarise yourself with the equipment and its limits. Keep the generator in good condition.

### 1.5.3 Personal protective clothing (PPE)

---

For maintenance and repair work on the equipment, **do not** wear loose, torn, or ill-fitting clothing that may catch on protruding parts or come into contact with pulleys, cooling disks, or other rotating parts, which can cause severe injury.



Wear appropriate safety and protective clothing during work.

Do not operate the generator while under the influence of alcohol, medications, or drugs.



Do not wear head phones or ear buds while operating, servicing, or repairing the equipment.



### 1.5.4 Cleanliness ensures safety

---

Keep the generator and its environment clean.

Before cleaning the generator, shut down the equipment and secure it against accidental start-up. Keep the generator free from dirt, grease, and waste. Store flammable liquids in suitable containers only and ensure adequate distance to the generator. Check the lines regularly for leakage and eliminate leaks immediately as applicable.



### 1.5.5 Safe handling of fuels and lubricants

Keep fuels and lubricants away from naked fire.

Before filling up the tank and/or applying lubricant, always shut down the generator and secure it against accidental start-up.



Do not smoke and avoid naked flame and sparking near fuels and the generator. Fuel is highly flammable and may explode under certain conditions.

Refuel in well-ventilated open spaces only. If fuel/lubricant was spilled, eliminate fluids immediately.

Do not mix diesel fuel with petrol or alcohol. Such a mixture can cause fire and will damage the generator.



Use only approved fuel containers and tank systems. Old bottles and canisters are not adequate.

### 1.5.6 Exhaust fumes and fire protection

Engine fumes can be hazardous to your health if they accumulate. Ensure that the generator exhaust fumes are vented appropriately (leak-proof system), and that an adequate fresh air supply is available for the generator and the operator (forced ventilation).



Check the system regularly for leakage and eliminate leaks as applicable.

Exhaust gases and parts containing such fumes are very hot; they may cause burns under certain circumstances. Always keep flammable parts away from the generator and the exhaust system.

To prevent fire, ensure that electrical connections are not short-circuited. Check regularly that all lines and cables are in good condition and that there is no chafing. Bare wires, open chafing spots, frayed insulation, and loose cable connections can cause dangerous electric shocks, short-circuit, and fire.



The generator shall be integrated in the existing fire safety system by the operating company.

## CALIFORNIA

### Proposition 65 Warning

Diesel engine exhaust and some of its constituents are known to the State of California to cause cancer, birth defects, and other reproductive harm.



### 1.5.7 Safety precautions against burns and battery explosions

The generator and its cooling agents and lubricants as well as the fuel can get hot while the generator is operated. Use caution around hot components such as parts containing exhaust fumes, radiator, hoses, and engine block during operation and after the generator was shut down.



The cooling system may be pressurised. Open the cooling system only after letting the engine and the coolant cool down. Wear appropriate protective clothing (e.g. safety goggles, gloves).



Prior to operation, ensure that the cooling system is sealed and that all hose clamps are tightened.

The battery represents an explosion hazard, this applies both to the starter battery and the battery bank of the AGT generators. While batteries are being charged, a hydrogen-oxygen mixture is generated, which is highly explosive (electrolytic gas).



Do not use or charge batteries if the fluid level is below the MINIMUM marking. The life span of the battery is significantly reduced, and the risk of explosion increases. Refill to a fluid level between maximum and minimum level without delay.

Especially during charging, keep sparks and naked fire away from the batteries. Ensure that the battery terminals are tightly connected and not corroded to avoid sparking. Use an appropriate terminal grease.



Check the charge level with an adequate voltmeter or acid siphon. Contact of a metal object across the terminals will result in short-circuiting, battery damage, and high explosion risk.

Do not charge frozen batteries. Heat the batteries to +16 °C (61 °F) prior to charging.

### 1.5.8 Protect your hands and body from rotating parts!

Always keep the capsule closed while operating the generator.

To check the V-belt tension, always shut down the generator.



Keep your hands and body away from rotating parts such as V-belt, fans, pulleys, and flywheel. Contact can cause severe injury.

Do not run the engine without the safety devices in place. Prior to start-up, mount all safety devices securely and check for proper attachment and function.

### 1.5.9 Anti-freeze and disposal of fluids

Anti-freeze contains toxic substances. To prevent injury, wear rubber gloves and wash off any anti-freeze immediately in case of skin contact. Do not mix different anti-freeze agents. The mixture may cause a chemical reaction generating harmful substances. Use only anti-freeze that was approved by Fischer Panda.



Protect the environment. Collect drained fluids (lubricants, anti-freeze, fuel), and dispose of them properly. Observe the local regulations for the respective country. Ensure that no fluids (not even very small quantities) can drain into the soil, sewers, or bodies of water.



### 1.5.10 Implementation of safety inspections and maintenance

---

Disconnect the battery from the engine before performing service work. Affix a sign to the control panel - both the main and the corresponding slave panel - with the instruction "DO NOT START UP - MAINTENANCE IN PROGRESS" to prevent unintentional start-up.



To prevent sparking due to accidental short-circuiting, always remove the earthing cable (-) first and reconnect it last. Do not start work until the generator and all fluids and exhaust system parts have cooled down.

Use only suitable tooling and appliances and familiarise yourself with their functions to prevent secondary damage and/or injury.



Always keep a fire extinguisher and a first aid box handy while performing maintenance work.

## 1.6 Warning and instruction signs

---

---

Keep warning and instruction signs clean and legible.

Clean the signs with water and soap and dry them with a soft cloth.

Immediately replace damaged or missing warning and instruction signs. This also applies to the installation of spare parts.

### 1.6.1 Special instructions and hazards of generators

---

The electrical installations may only be carried out by trained and qualified personnel!



**The generator must not be operated with the cover removed.**

If the generator is being installed without a sound insulation capsule, it must be ensured that all rotating parts (belt-pulley, belts etc.) are covered and protected so that there is no danger to life and body!



If a sound insulation covering will be produced at the place of installation, then easily visible signs must show that the generator must only be switched on while the capsule is closed.



All servicing, maintenance, or repair work may only be carried out when the motor is not running.

Electrical voltages above 60 volts are always dangerous to life. The rules of the respective regional authority must be adhered to during installation. For safety reasons, only an electrician may carry out the installation of the electrical connections of the generator.

### 1.6.1.1 Protective conductor and potential equalisation:

Electric voltage above 60 V may be life-threatening. For this reason systems are grounded with a protective conductor. In connection with a RCD the current supply will be disconnected in case of a failure.

Appropriate safety precautions like the RCD and corresponding fuses have to be provided by the customer to guarantee a safe operation of the generator.

### 1.6.1.2 Protective conductor for Panda AC generators:

The generator is „earthed“ as a standard (centre and ground are interconnected in the generator terminal box by a shunt). This is a basic first-level safety measure, which offers protection as long as no other measures are installed. Above all, it is designed for delivery and a possible test run.



This „neutralisation“ (Protective Earthing Neutral - PEN) is only effective if all parts of the electrical system are jointly „earthed“ to a common potential. The shunt can be removed if this is necessary for technical reasons and another protective system has been set up instead.

**While the generator is being operated, the full voltage is applied to the AC control box, as well. Therefore, it is essential to ensure that the control box is closed and secured against touch while the generator is running.**



**The battery must always be disconnected if work on the generator or electrical system is to be carried out, so that the generator cannot be started up unintentionally.**

### 1.6.1.3 Switch off all loads while working on the generator

All loads must be disconnected prior to working on the generator to avoid damage to the devices. In addition, the semiconductor relays in the AC control box must be disconnected in order to avoid the booster capacitors being activated during set-up. The negative terminal of the battery must be disconnected.

Capacitors are required to run the generator. These have two varying functions:

- A) The working capacitors
- B) The booster capacitors

Both groups are located in a separate AC control box.

Capacitors store electrical energy. High voltages may remain across the capacitor contacts even after they have been disconnected from the mains. As a safety precaution, do not touch the contacts. If the capacitors must be replaced or inspected, the contacts shall be short-circuited by connecting an electrical conductor to discharge potentially remaining potential differences.

If the generator is switched off normally, the working capacitors are automatically discharged via the winding of the generator. The booster capacitors are discharged by means of internal discharge resistors.

For safety reasons, all capacitors must be discharged through short-circuiting before work is carried out on the AC control box.

### 1.6.1.4 Potential equalisation for Panda AGT DC generators

For further information specific to your generator, see the chapter installation.

### 1.6.1.5 Safety instructions concerning cables

#### Cable types

It is recommended to use cables that are in compliance with the standard UL 1426 (BC-5W2) with type 3 (ABYC section E-11).

#### Cable cross-section

The cable shall be selected taking into account the amperage, cable type, and conductor length (from the positive power source connection to the electrical device and back to the negative power source connection).







#### Cable installation

It is recommended to install a self-draining cable conduit classified as V-2 or higher in compliance with UL 94 in the area of the cable guide inside the capsule. It must be ensured that the cable guide is not routed along hot surfaces such as the exhaust manifold or the engine oil drain screw but instead is installed free from any influence due to friction and crushing.


## 1.6.2 General safety instructions for handling batteries

---

**These instructions shall apply in addition to the instructions of the battery manufacturer:**

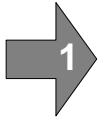
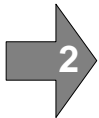
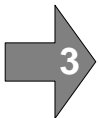

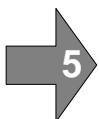
- While you are working on the batteries, a second person should be within earshot to help you if necessary. 
- Keep water and soap ready in case battery acid is burning your skin.
- Wear eye protection and protective clothing. Do not touch your eyes while handling batteries.
- If you have acid splashes on the skin or clothing, wash them out with lots of water and soap.
- If acid sprays into your eyes, immediately flush them with clean water until no more burning is felt. Immediately seek medical assistance. 
- Do not smoke near the batteries. Avoid naked fire. The area around batteries is a potentially explosive atmosphere.
- Ensure that no tools are dropped on the battery terminals; cover them as necessary.
- Do not wear jewellery or watches on your arms during installation that might short-circuit the battery. Otherwise, there is a risk of skin burns. 
- Protect all battery contacts against accidental contact.
- For battery banks: Use only deep cycle batteries. Starter batteries are not suitable. Lead-acid gel batteries are recommended. They are maintenance-free, cycle stable, and do not release gases. 
- Never charge a frozen battery.
- Avoid battery short-circuits.
- Ensure proper ventilation of the battery to vent gases that may be released.
- Battery connection terminals must be checked for proper seating before operation. 
- Battery connection cables shall be installed with utmost care and shall be checked for excessive heating under load. Check the battery near vibrating components regularly for chafing and insulation defects. 

**ATTENTION! For battery charger generators (Fischer Panda AGT-DC)!**

**Prior to installation, verify that the voltage of the battery bank complies with the output voltage of the generator.** 

## 2. In case of Emergency First Aid / Im Notfall - Erste Hilfe



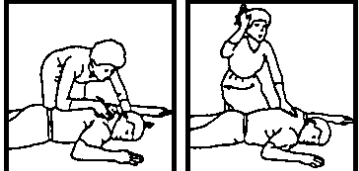
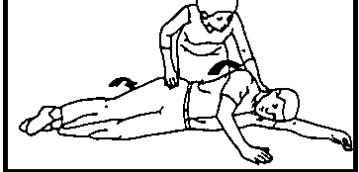
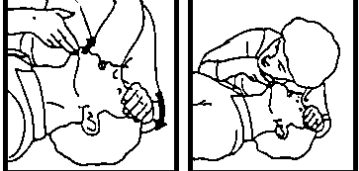



	<p>First Aid in case of accidents by electrical shocks</p> <p>5 Safety steps to follow if someone is the victim of electrical shock</p>	
	Do not touch the injured person while the generator is running.	
	Switch off the generator immediately.	
	If you cannot switch off the generator, pull, push, or lift the person to safety using a wooden pole, rope or some nonconducting material.	
	Call an emergency doctor as soon as possible.	
	Immediately start necessary first aid procedures.	

## 2.7 WHEN AN ADULT STOPS BREATHING

**DO NOT attempt to perform the rescue breathing techniques provided on this page, unless certified. Performance of these techniques by uncertified personnel could result in further injury or death to the victim.**

**Warning:**



<p><b>1</b> Does the Person Respond? Tap or gently shake victim. Shout, "Are you OK?"</p>		<p><b>2</b> Shout, "Help!" Call people who can phone for help.</p>
<p><b>3</b> Roll Person onto Back. Roll victim towards you by pulling slowly.</p>		
<p><b>4</b> Open Airway. Tilt head back, and lift chin. Shout, "Are you OK?"</p>		<p><b>5</b> Check for Breathing. Look, listen, and feel for breathing for 3 to 5 seconds.</p>
<p><b>6</b> Give 2 Full Breaths. Keep head tilted back. Pinch nose shut. Seal your lips tight around victim's mouth. Give 2 full breaths for 1 to 1½ seconds each.</p>		
<p><b>7</b> Check for Pulse at side of Neck. Feel for pulse for 5 to 10 seconds.</p>		<p><b>8</b> Phone EMS for Help. Send someone to call an ambulance.</p>
<p><b>9</b> Begin Rescue Breathing. Keep head tilted back. Lift chin. Pinch nose shut. Give 1 full breath every 5 seconds. Look, listen, and feel for breathing between breaths.</p>		<p><b>10</b> Recheck Pulse Every Minute. Keep head tilted back. Feel for pulse for 5 to 10 seconds. If victim has pulse, not breathing, continue rescue breathing. If no pulse, begin CPR.</p>



## 3. Basics

### 3.1 Intended use of the machine

---

---

The Fischer Panda generator is made to produce electrical energy out of diesel fuel.

The diesel fuel is converted to mechanical energy by the diesel engine. This mechanical energy drives the generator. In the genset, the mechanical energy is converted to electrical energy. This process is controlled by (sometimes external) components, the remote control panel and the VCS (voltage control system).

Sufficient amount of fuel and combustion air is necessary for this process. Arising exhaust and heat must be conducted according to the specification.

If the electrical power is fed to a local net, the regulations and installation instructions of the system operator and the regional authorities with reference to the power network/shipboard power supply system must be respected. Safety applications and safety devices (including lightening conductor, personal protection switch, ect.) have to be installed.

Misapplication of the product can damage and destroy the product and the electrical net inclusive all load which is attached to the net, and contain hazards like short circuit, ect. It is not allowed to modify the product in any case. Never open the sound cover during operation! The safety and hazard notes of the manual must be respected!

### 3.2 Purpose of the manual and description of the definitions of the trained persons/operators/users

---

---

This manual contains the working instructions and operating guidelines for the owner and user of Fischer Panda generators.

The manual is the base and the guideline for the correct installation and maintenance of Fischer Panda generators. It does not substitute the technical evaluation and should be used as an example guide only. The installation must be undertaken and proved by a suitable qualified/trained person and should be in accordance with the law as required by the country and special situation. All work has to be undertaken according to the state of the technology.

#### 3.2.1 Trained persons

---

**Qualified persons for the mechanical components are motor mechanics or persons with similar qualification and training.**

**Trained persons for the electrical components are electricians or persons with similar qualification and training.**

After the installation the trained person has to instruct the operator/owner about the operation and maintenance of the generator. This must include the hazards of the generator use.

#### 3.2.2 Operator/Owner

---

**The operator is responsible for the operation of the generator.**

After the installation, the operator/owner must be instructed concerning the operation and maintenance of the generator. This has to include the hazards during operation of the generator, different operating conditions, and instructions for the maintenance.

The operator/owner must read and follow the manual and must respect the hazard notes and safety instructions.

### 3.2.3 User

---

**Users are persons, established by the operator/owner, to operate the generator.**

The operator/owner has to ensure that the user has read and understood the manual and that all hazard notes and safety instructions are respected. The user must be instructed by the operator/owner regarding his activity at the generator, especially concerning the maintenance.

## 3.3 Components of the xGenerator

---

### 1. Panda xGenerator

*representative picture*

Fig. 3.3-1: Panda xGenerator



### 2. Control Panel Panda xControl

*representative picture*

Fig. 3.3-2: xControl panel

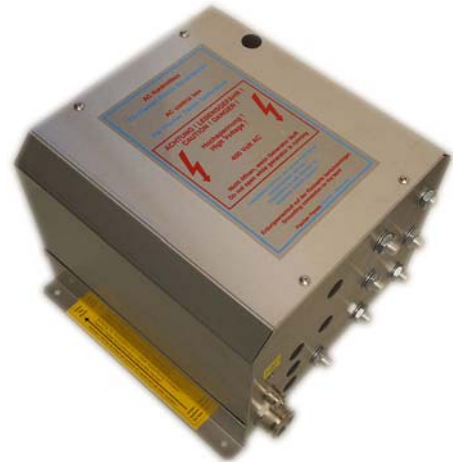


3. AC-Control Box

*representative picture*

*Not present at all models*

Fig. 3.3-3: AC-Control box



4. FP- Bus cable 15 mtr

Fig. 3.3-4: FP- Bus cable 15 mtr



5. Termination resistor

Fig. 3.3-5: Termination resistor



## 6. Fischer Panda manual

The Fischer Panda manual comprises the following components:

- a.- Transparent envelope with general information, warranty terms, installation certificates, and service list.
- b.- Generator manual
- c.- Spare parts catalogue „Installation & Service Guide“
- d.- Engine manual from the engine manufacturer
- e.- Generator circuit diagram

*representative picture*

Fig. 3.3-6: Manual



## 3.4 Range of operation

---

Reliable power supply on vehicles.

## 3.5 Panda transport box

---

### 3.5.1 Bolted Fischer Panda transport box

---

1. Remove the bolts for cover / sidewalls
2. Remove the cover
3. Remove the loose accessories
4. Remove the bolts for sidewalls / floor pallet
5. Remove the sidewalls
6. Open the generator attachment

### 3.5.2 Fischer Panda transport box with metal tab closure

---

1. Bend up the metal tab closures on the transport box lid
2. Remove the cover
3. Remove the loose
4. Bend open the metal tab closures at the bottom of the transport box
5. Remove the sidewalls
6. Open the generator attachment

### 3.6 Opening the MPL sound insulation capsule

To open the sound insulation capsule, the closures must be rotated roughly 180° counter-clockwise. Use a flat head screwdriver. Pull the sidewalls out by gripping into the slots.



Closure locked

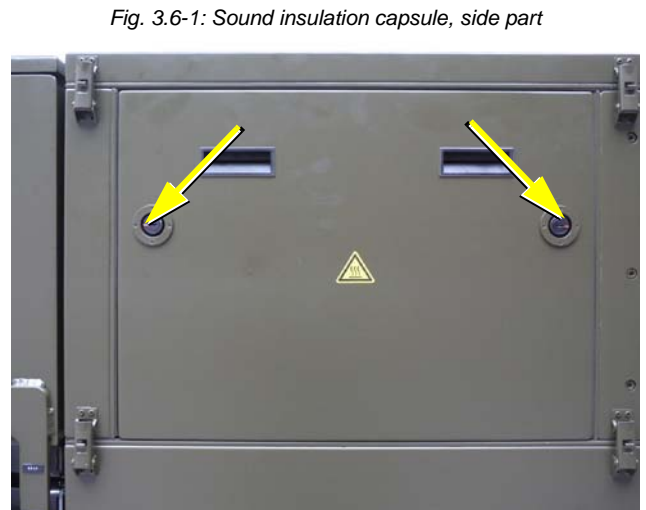


Fig. 3.6-1: Sound insulation capsule, side part

Fig. 3.6-2: Closure locked



Closure open

Fig. 3.6-3: Closure open



### 3.6.1 Opening the GFK sound insulation capsule

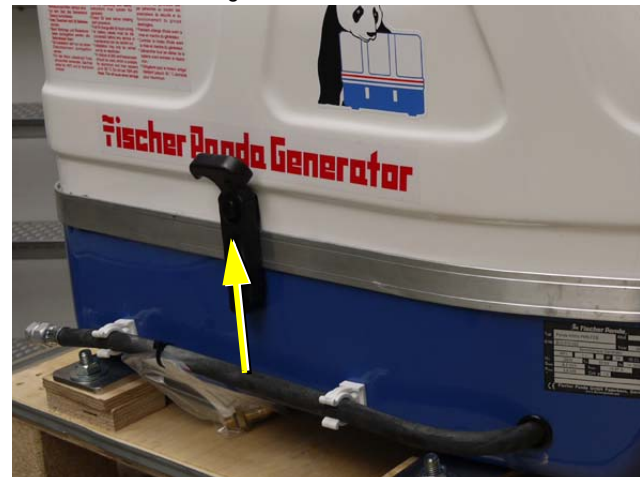
#### GFK sound insulation capsule with lash closures

Fig. 3.6-1: Lash closures



To open the lash closures pull the handle in arrow direction and lift the lash of the closure pin. After lifting off the lashes, the sound isolation cover upper part can be removed.

Fig. 3.6-2: Lash closures



## 3.7 Transport and loading/unloading

### 3.7.1 Transporting the generator

- The generator must always be upright for transport.
- For transport, the Fischer Panda transport box shall be used for the generator. The generator shall be securely attached to the bottom of the box.
- For loading/unloading, an adequate industrial truck shall be used.
- Depending on the transport distance (e.g. air cargo), the generator fluids (coolant, engine oil, fuel) may have to be drained. The corresponding instructions and warnings must be fitted to the transport packaging.

### 3.7.2 Loading/unloading of the generator

For loading/unloading the generator, appropriate ring eye bolts shall be installed in the holes in the support rails. The load bearing capacity of each ring eye bolt must at least equal the generator weight.

An adequate lifting yoke shall be used for transport/loading.

Fig. 3.7.2-1: Lifting yoke (example)



### 3.8 Special service instructions and measures for extended machine downtimes and decommissioning

The decommissioning and storage must be undertaken and proved regarding the operation and storage situation. **Note:**



**Fischer Panda takes no responsibility for damages through wrong decommissioning and storage.**

Downtimes are categorised in the following groups:

- Short downtime (1 to 3 months)
- Medium term downtime / hibernation (3 to 6 months)
- Extended downtime / decommissioning (more than 6 months)

#### 3.8.1 Instructions for the starter battery for extended downtimes

##### Starter batteries

**Note: Information starter battery**

Self-discharge of batteries is a physical and chemical process and cannot be avoided even if the battery is disconnected



- For extended downtimes, the battery shall be disconnected from the genset.
- Charge battery regularly. Observe instructions of the battery manufacturer.

Depending on the battery type, check the acid level before charging and refill each cell up to the marking using distilled water as necessary.

Modern starter batteries are typically maintenance-free.

**Deep discharge will damage the battery and can render it unusable.**

Keep battery clean and dry. Clean battery poles (+ and -) and terminals regularly and coat with acid-free and acid-resistant grease. During assembly, ensure good contact of the terminal connections.

General limits for lead-acid batteries:

2.1 V / cell corresponds with full battery (charged).

1.95 V / cell corresponds with empty battery - recharge.

For a 12 V battery, the following applies:

- 11.7 V lower open-circuit voltage (battery empty), recharge battery.
- 12.6 V upper open-circuit voltage (full battery) - trickle charge full battery at 13.2 V.

For a 24 V battery, the following applies:

- 23.4 V lower open-circuit voltage (battery empty), recharge battery.
- 25.2 V upper open-circuit voltage (full battery) - trickle charge full battery at 26.4 V.

*These values are based on a battery temperature of 20-25°C. Observe the instructions from the battery manufacturer.*

**Fischer Panda recommends:**

- Install battery circuit breaker and switch to OFF on the machine. (Cutting the battery circuit.)
- Secure the battery plus terminal close to the battery.
- Regularly check contacts for corrosion.

**Note: Starter battery recommendation**



### 3.8.2 Measures for short downtimes

---

Short downtime (1 to 3 months)

- Measure battery charge status based on open-circuit voltage.
- During downtimes >7 days, disconnect battery (e.g. battery main switch to position 0).
- Check the battery within 2 months and allow the engine to warm up for min. 10 min.
- Fill fuel tank to 100% (level to full).

### 3.8.3 Measures for medium term downtimes / hibernation

---

Medium term downtimes (3 to 6 months)

#### 3.8.3.1 Courses for preservation:

- Check battery charge status and recharge regularly, roughly every 2 months, as necessary. Observe instructions of the battery manufacturer.
- Check cooling water anti-freeze level and refill as necessary.

The anti-freeze agent must not be older than 2 years. The anti-freeze content shall be between 40 % and 60 % to ensure corrosion protection of the cooling water circuit. Top off coolant if necessary.

If the cooling water is drained, e.g. after engine surface protection is applied, no water may remain inside the engine during the downtime. The control unit must be marked accordingly with a note specifying "NO COOLING WATER".

- Drain engine oil as specified. Refill engine with preservative oil to the max. level on the oil dipstick.
- Drain diesel from tank and refill with a protective mixture (90 % diesel and 10 % preservative oil) (level to full).

**Crank engine without start.**

- Dismount V-belt as specified, wrap and store in a dry location. Protect against UV radiation.

**Cover alternator apertures.**

**Attention!**

Cleaning fluids and preservatives must not enter the alternator. Risk of destroying the alternator.



- Clean engine as per manufacturer's instructions.



- Spray engine parts and V-belt disks with preservative.
- Clean air filter housing and spray with preservative (metal housing only).
- Close off intake and exhaust apertures (e.g. with tape or end caps).

**Before recommissioning, remove preservatives and protective measures.**

**Attention!**



### **3.8.3.2 Measures for removing surface protection after medium term downtimes (3 to 6 months).**

- Check battery charge status and recharge if necessary. Observe instructions of the battery manufacturer.
- Check cooling water anti-freeze level and cooling water level and refill as necessary.
- Drain engine oil. Replace oil filter and engine oil as per the specification.
- Remove preservatives from the engine with petroleum spirit.
- Degrease V-belt disks and mount V-belt according to instructions. Check V-belt tension!
- If applicable, open turbocharger oil pressure line and fill clean engine oil into channel.
- Hold engine stop lever in zero delivery position and crank engine manually several times.
- Clean air filter housing with petroleum spirit, check air filter and replace if necessary.
- Remove covers from exhaust aperture and intake apertures.
- Connect battery. Close battery main switch.
- Hold stop lever on generator motor in neutral position and crank starter for approx. 10 seconds. Then, pause for 10 seconds. Repeat this procedure 2 times.
- Perform visual check of the generator similar to initial commissioning and start up generator.

## **3.8.4 Measures for extended downtimes / decommissioning**

---

Downtimes (more than 6 months)

### **3.8.4.1 Courses for preservation:**

- Check battery charge status and recharge regularly, roughly every 3 months, as necessary. Observe instructions of the battery manufacturer.
- Check cooling water anti-freeze level and refill as necessary.

The anti-freeze agent must not be older than 2 years. The anti-freeze content shall be between 40 % and 60 % to ensure corrosion protection of the cooling water circuit. Top off coolant if necessary.

If the cooling water is drained, e.g. after engine surface protection is applied, no water may remain inside the engine during the downtime. The control unit must be marked accordingly with a note specifying "NO COOLING WATER".

- Drain engine oil as specified. Refill engine with preservative oil to the max. level on the oil dipstick.
- Drain diesel from tank and refill with a protective mixture (90 % diesel and 10 % preservative oil) (level to full).

#### **Crank engine without start.**

- Dismount V-belt as specified, wrap and store in a dry location. Protect against UV radiation.
- Disconnect battery. Coat terminals with acid-free grease.

**Cover alternator apertures.**

Cleaning fluids and preservatives must not enter the alternator. Risk of destroying the alternator.

- Clean engine as per manufacturer's instructions.
- Spray engine parts and V-belt disks with preservative.
- Clean air filter housing and spray with preservative (metal housing only).
- Spray preservative on intake and exhaust side of exhaust turbocharger (where applicable) and reconnect the lines.
- Remove valve cover and spray inside of valve cover, valve stems, springs, rocker, etc. with preservative oil.
- Remove injection nozzle and coat cylinder surface with preservative oil. Hold stop lever in zero delivery position and crank engine manually several times. Refit injection nozzles with new seals (at an operation hour of min. 100 hours after the last change). Observe torque values.
- Spray radiator cover and tank cover or radiator cover on expansion tank lightly with preservative oil and refit.
- Close off intake and exhaust apertures (e.g. with tape or end caps).

**Attention!**



**For storage for more than 12 months, the preservation measures shall be checked annually and supplemented as necessary.**

**Note:**



**Before recommissioning, remove preservatives and protective measures.**

**Attention!**



**3.8.4.2 Measures for removing surface protection after extended downtimes / recommissioning (over 6 months):**

- Check battery charge status and recharge if necessary. Observe instructions of the battery manufacturer.
- Check cooling water anti-freeze level and cooling water level and refill as necessary.
- Drain engine oil. Replace oil filter and oil as per the specification.
- Remove preservatives from the engine with petroleum spirit.
- Degrease V-belt disks and mount V-belt according to instructions. Check V-belt tension!
- If applicable, open turbocharger oil pressure line and fill clean engine oil into channel.
- Hold engine stop lever in zero delivery position and crank engine manually several times.
- Clean air filter housing with petroleum spirit, check air filter and replace if necessary.
- Remove covers from exhaust aperture and intake apertures.
- Connect battery. Close battery main switch.
- Hold stop lever on generator motor in neutral position and crank starter for approx. 10 seconds. Then, pause for 10 seconds. Repeat this procedure 2 times.
- Perform visual check of the generator similar to initial commissioning and start up generator.

**Fischer Panda recommends:**

After extended downtimes, a full 150 h inspection as per the inspection list should be performed.

**Note:**



## 4. The Panda Generator

### 4.1 Type plate at the Generator

Fig. 4.1-1: Type plate

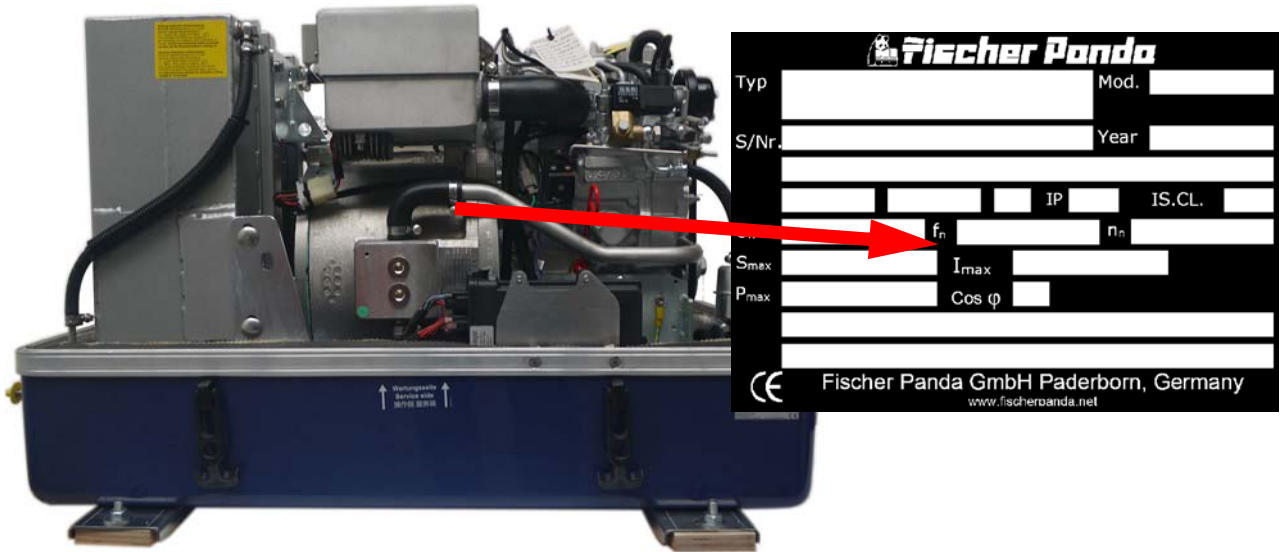
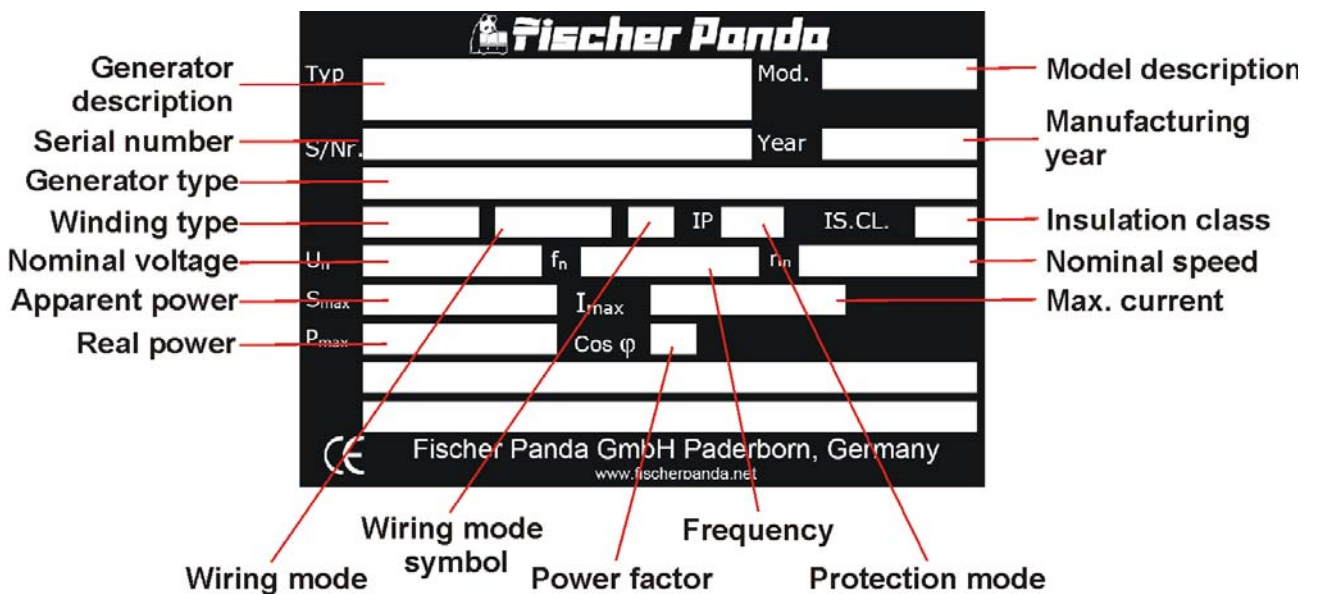


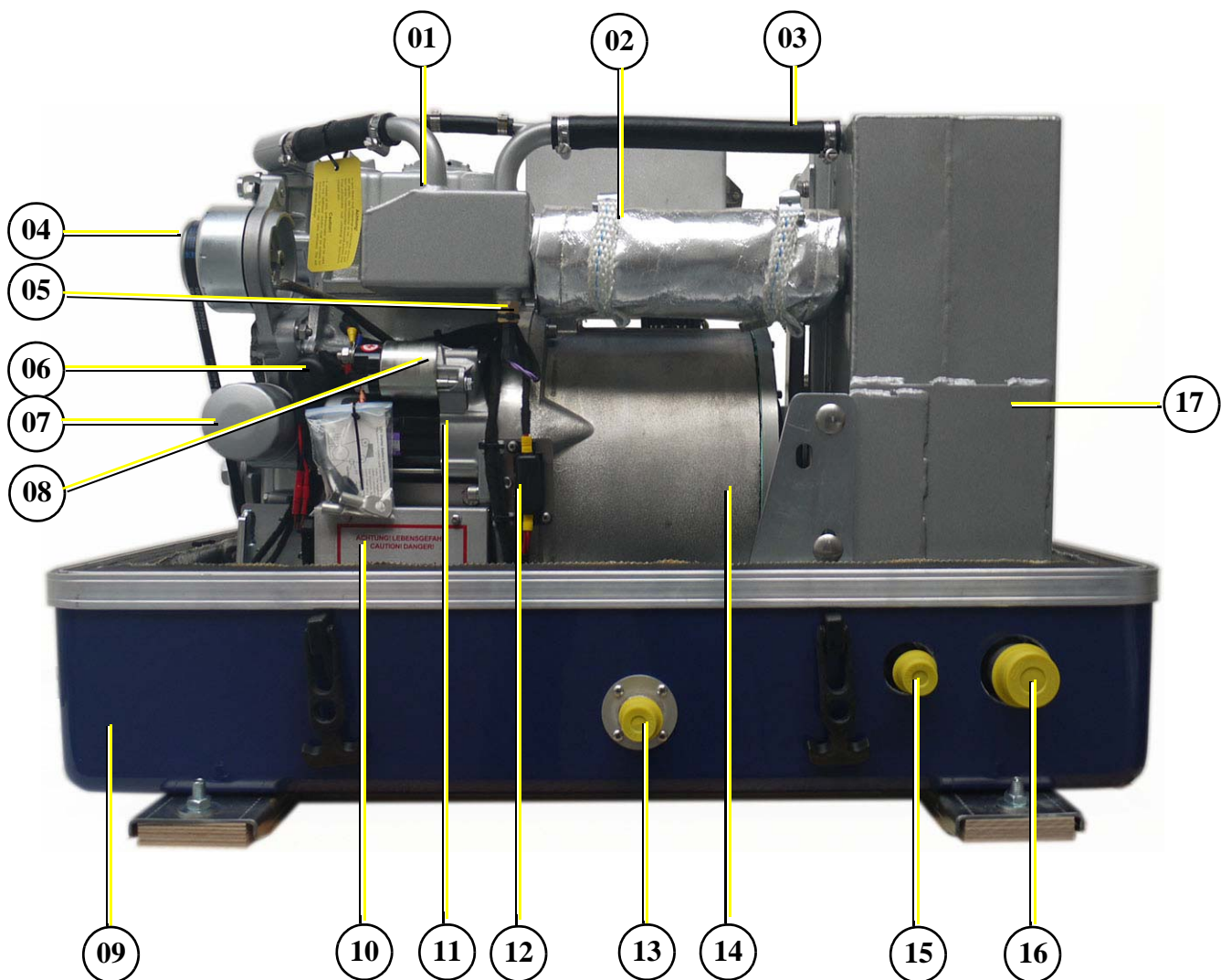
Fig. 4.1-2: Discription type plate



## 4.2 Description of the Generator

### 4.2.1 Right Side View

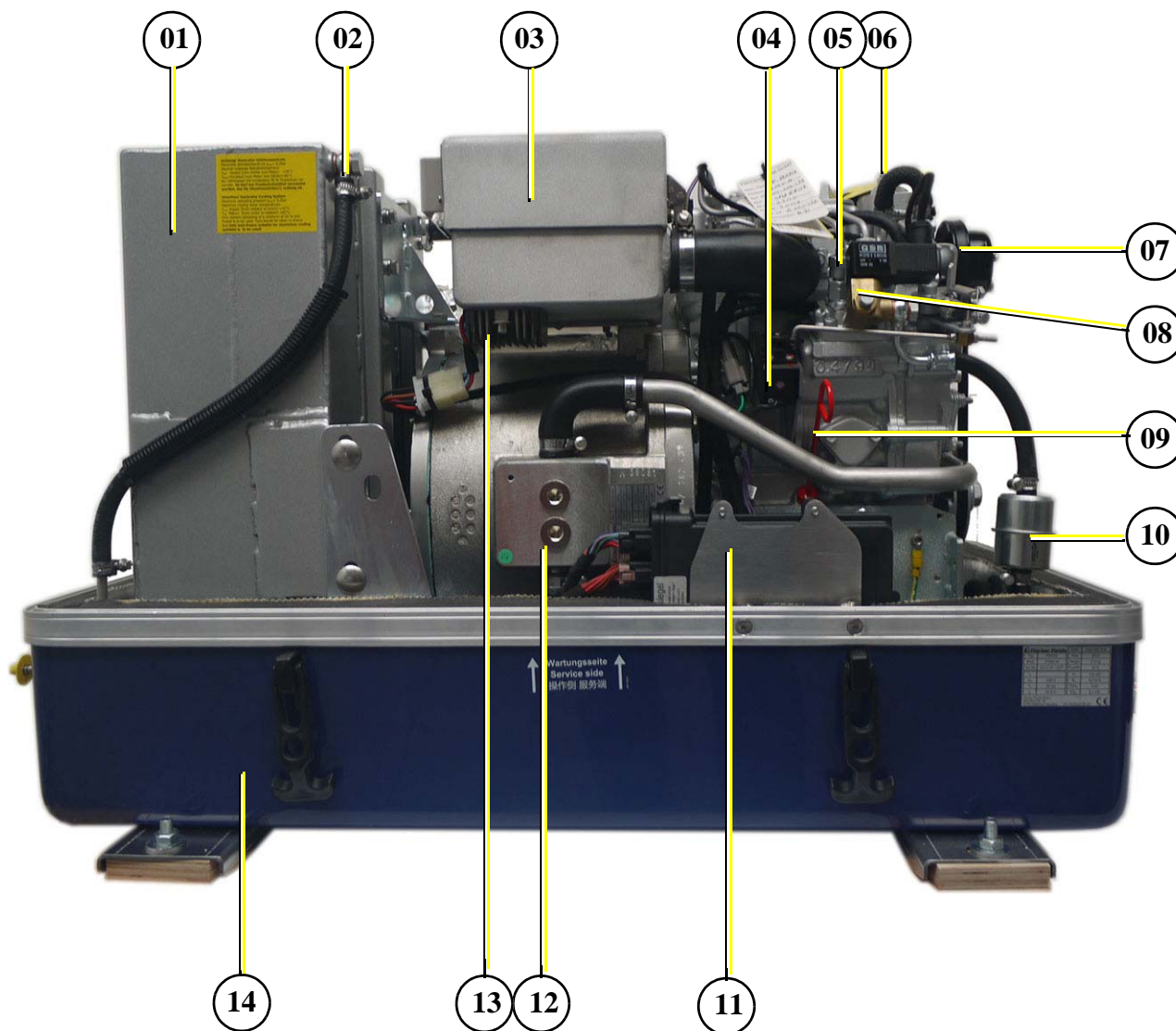
Fig. 4.2.1-1: Right Side View



- |  |                                     |
|--|-------------------------------------|
| 01. Water-cooled exhaust elbow             | 10. Generator power terminal box    |
| 02. Compensator under heat isolation       | 11. Starter motor                   |
| 03. Coolant pipe, exhaust elbow - silencer | 12. DC fuse                         |
| 04. DC-alternator                          | 13. Connection cooling water inlet  |
| 05. Thermo-sensor exhaust elbow            | 14. Generator housing with coil     |
| 06. Oil pressure switch                    | 15. Connection cooling water output |
| 07. Oil filter                             | 16. Connection exhaust hose         |
| 08. Solenoid for starter motor             | 17. Water-cooled silencer           |
| 09. Sound cover base part                  |                                     |

## 4.2.2 Left Side View

Fig. 4.2.2-1: Left side View



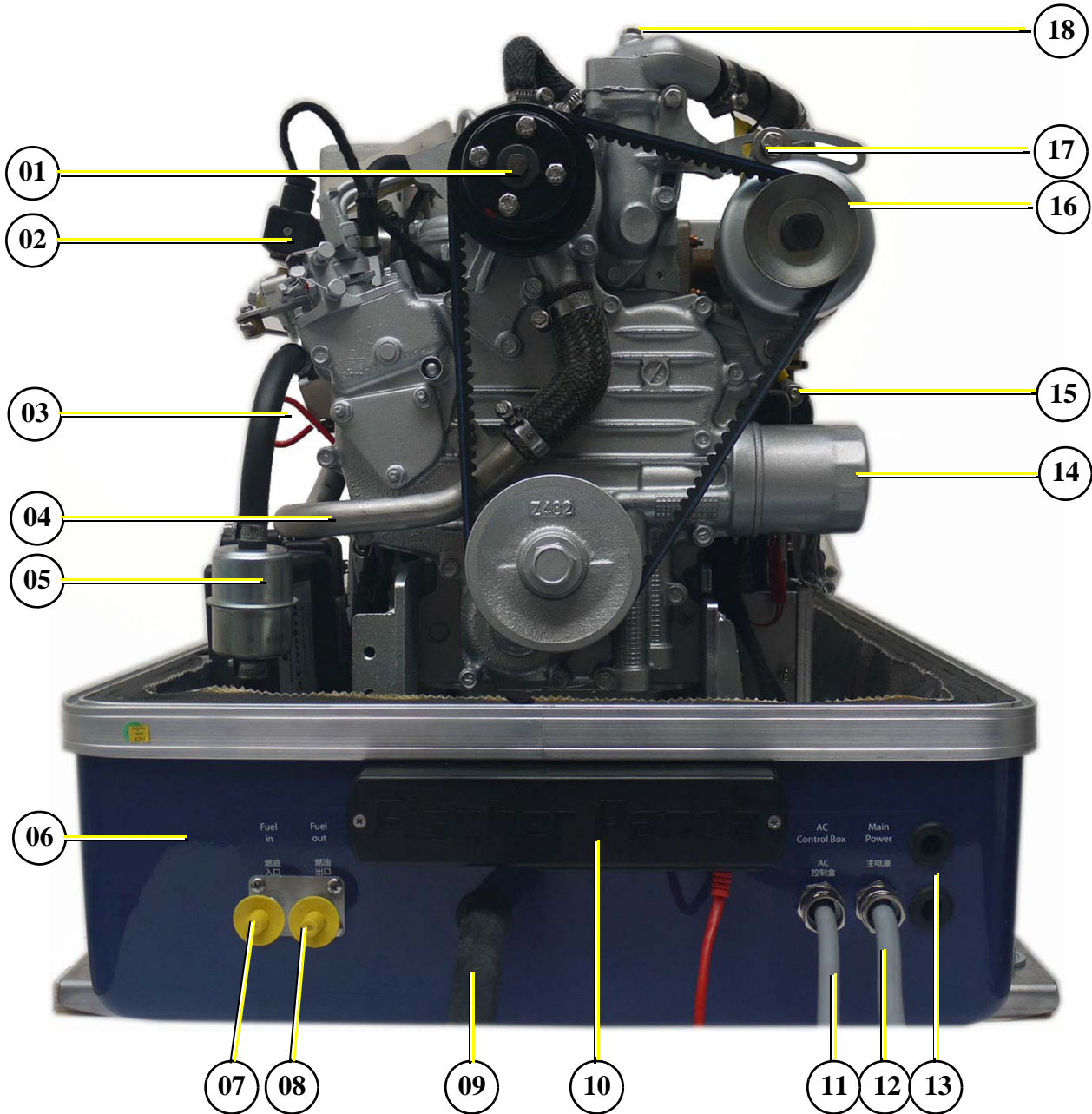
- 01. Water-cooled silencer
- 02. Ventilation screw silencer
- 03. Air suction housing with air filter
- 04. Actuator for rpm-regulation
- 05. Injection nozzle
- 06. Ventilation screw thermostat housing
- 07. Pulley for internal cooling water pump

- 08. Fuel solenoid valve
- 09. Oil dipstick
- 10. Fuel filter
- 11. xControl ECU
- 12. Dynamo controller
- 13. Cooling water connection block
- 14. Sound cover base part



### 4.2.3 Front View

Fig. 4.2.3-1: Front view

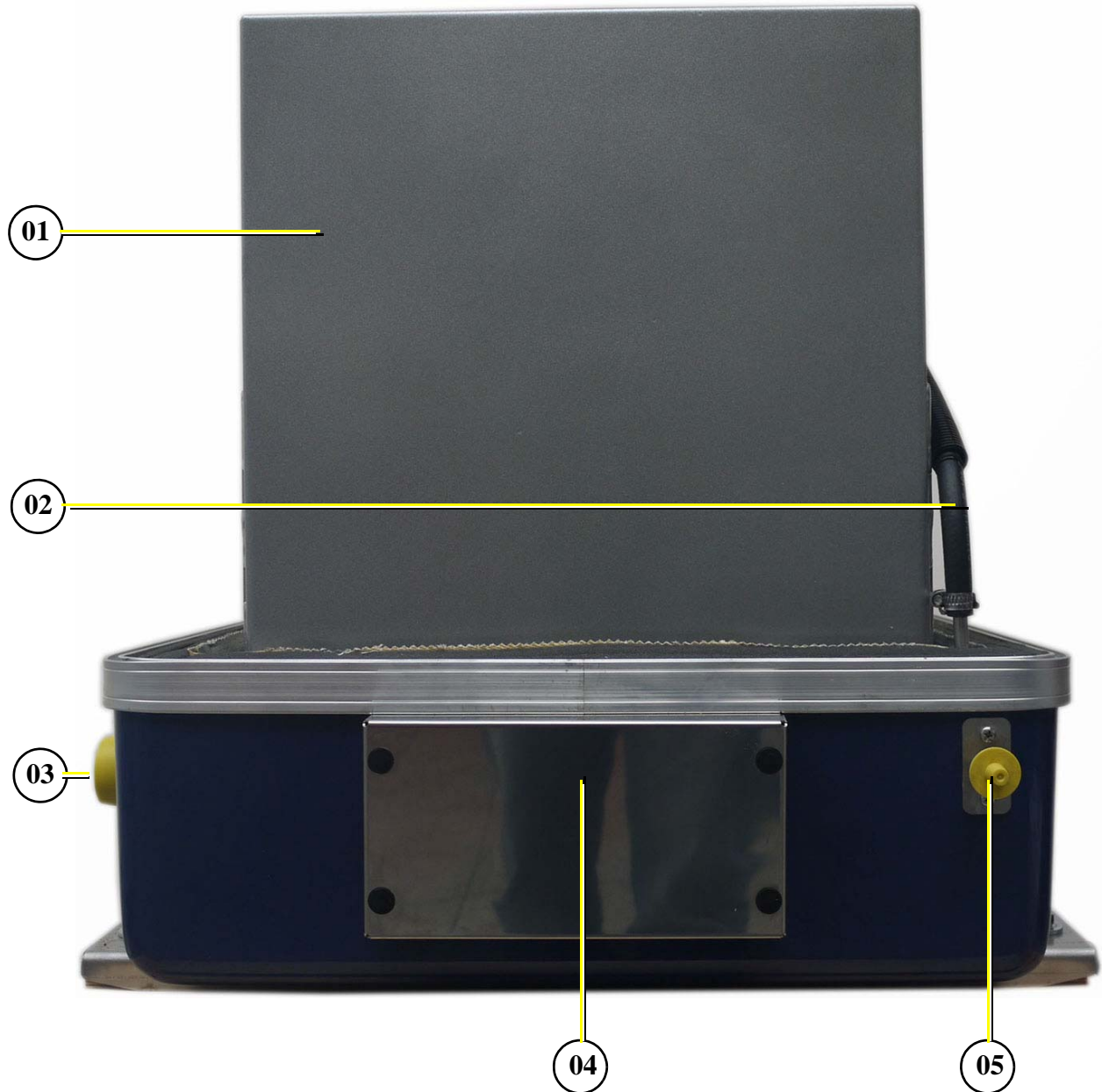


- 01. Pulley for internal cooling water pump
- 02. Fuel solenoid valve
- 03. Oil dipstick
- 04. Cooling water intake pipe
- 05. Fuel filter
- 06. Sound cover base part
- 07. Connection fuel in
- 08. Connection fuel out
- 09. Oil drain hose

- 10. xControl connection panel
- 11. Cable AC-Control box
- 12. Cable Load
- 13. Passage for starter battery minus (-) and plus (+)
- 14. Oil filter
- 15. V-belt for DC-alternator and internal cooling water pump
- 16. DC-alternator
- 17. Clamp device for DC-alternator
- 18. Ventilation screw thermostat housing

#### 4.2.4 Back View

Fig. 4.2.4-1: Back view



- 01. Water-cooled silencer
- 02. Return-flow external expansion tank
- 03. Connection exhaust hose

- 04. Air intake
- 05. Connection external expansion tank

## 4.3 Details of functional units

### 4.3.1 xControl panel

The control panel is fitted with various monitoring functions, which increase functional reliability and operating safety of the generator. Various parts of the generator are monitored with sensors which, when triggered, generate an error message and can shut down generator operation under certain circumstances to prevent damage.

Fig. 4.3-1: xControl CP-G Front Side



Fig. 4.3.1-2: xControl CP-G Reverse Side



See xControl manual for details!

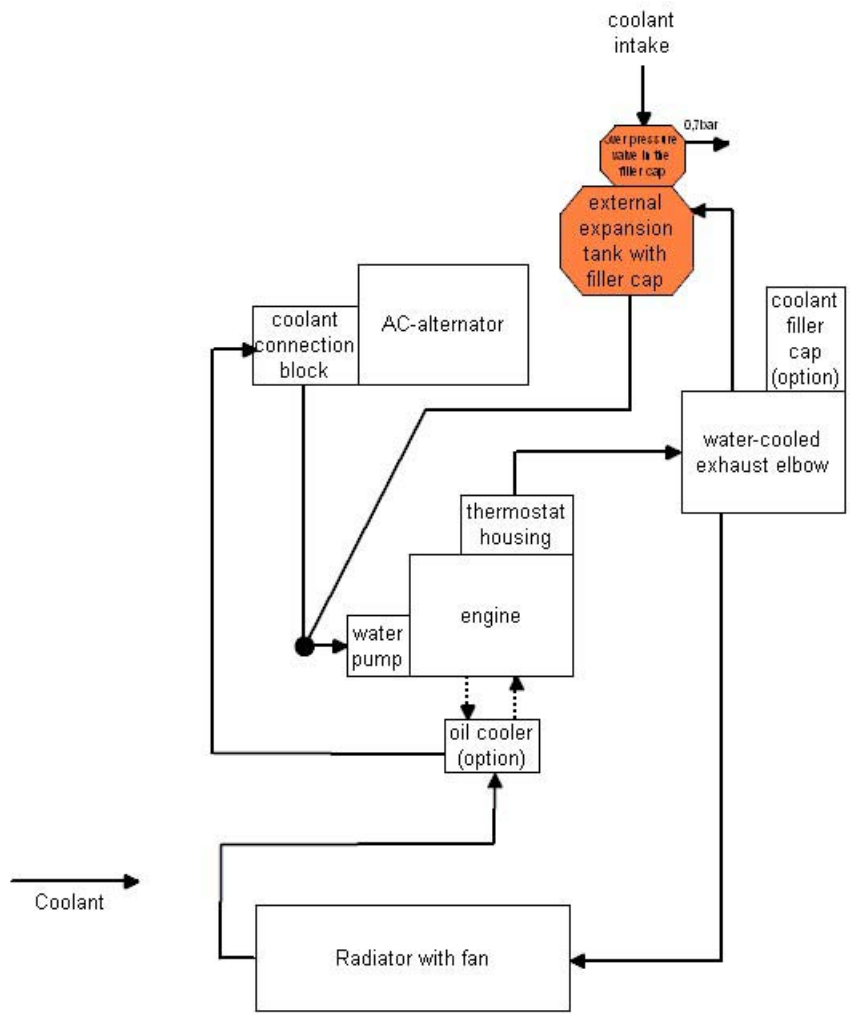
Notice!:





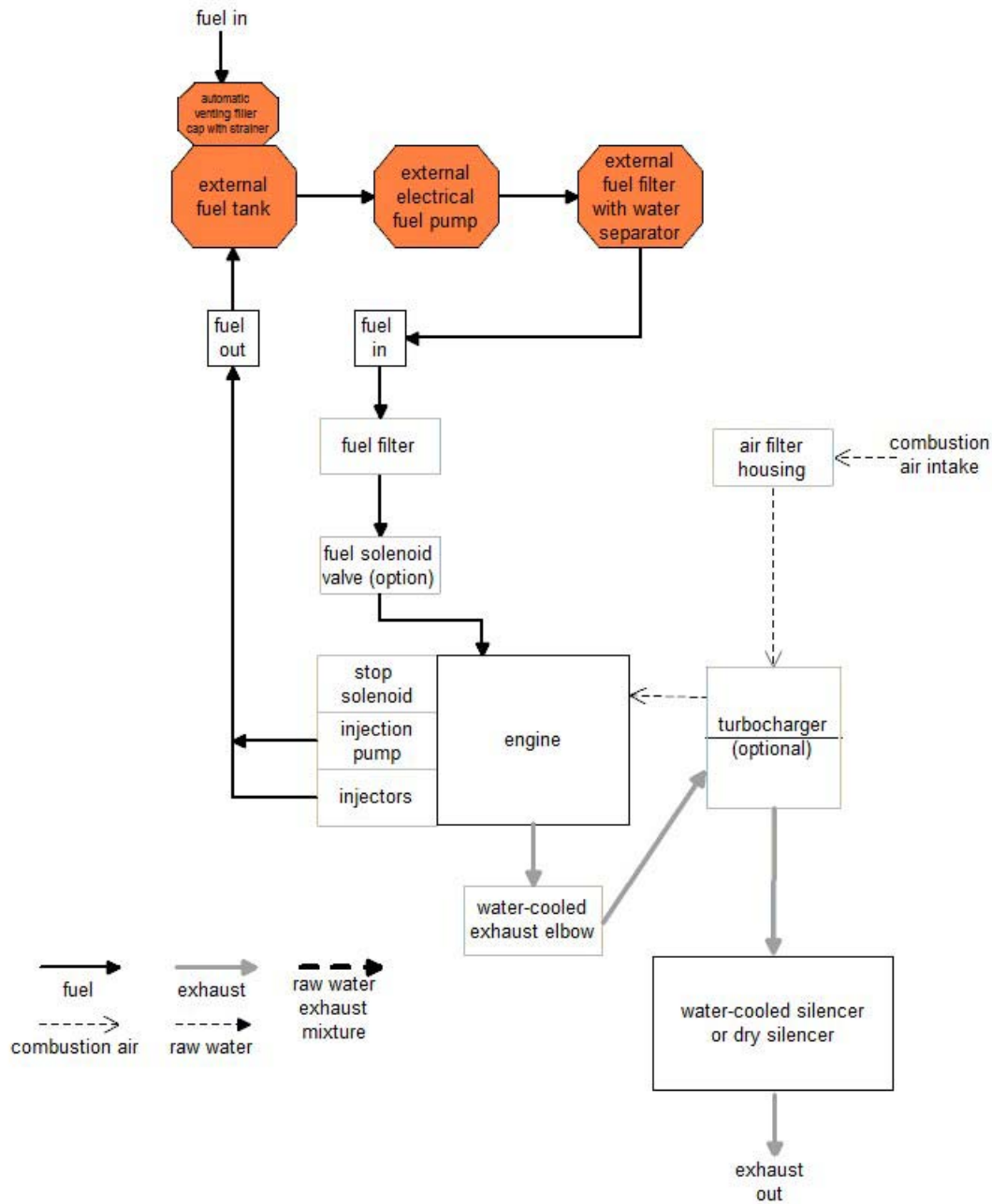
### 4.3.2 The cooling system

Fig. 4.3.2-1: The cooling system



### 4.3.3 The fuel and combustion air system

Fig. 4.3.3-1: The fuel and combustion air system



#### 4.3.4 Components of electrical system

#### 4.3.5 Sensors and switches for operating surveillance

##### Thermo-sensor at cylinder head

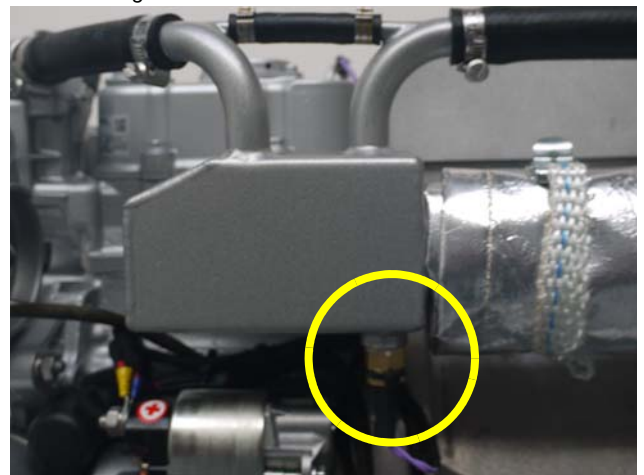
The thermo-sensor at the cylinder head serves the monitoring of the generator temperature.

Fig. 4.3.5-1: Thermo-switch cylinder head



##### Thermo-sensor at water-cooled exhaust elbow

Fig. 4.3.5-2: Thermo-switch at exhaust elbow

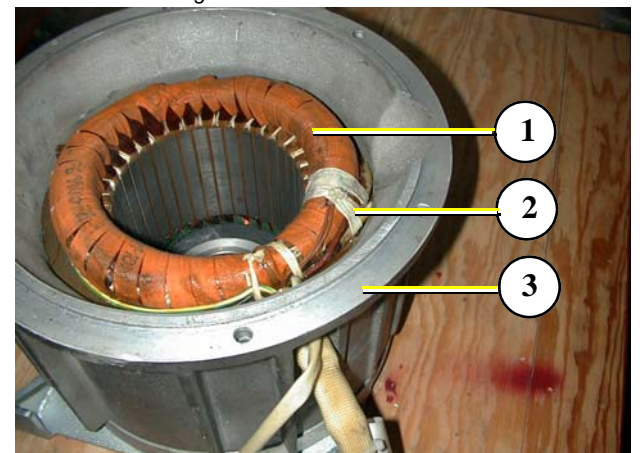


##### Thermo-switch in the generator coil

1. Generator coil
2. Thermo-sensor
3. Housing

For the protection of the generator coil there are two thermo-switches inside the coil, which are inserted parallel and safety's sake independently from each other.

Fig. 4.3.5-3: Coil thermo-switch



### Oil pressure switch

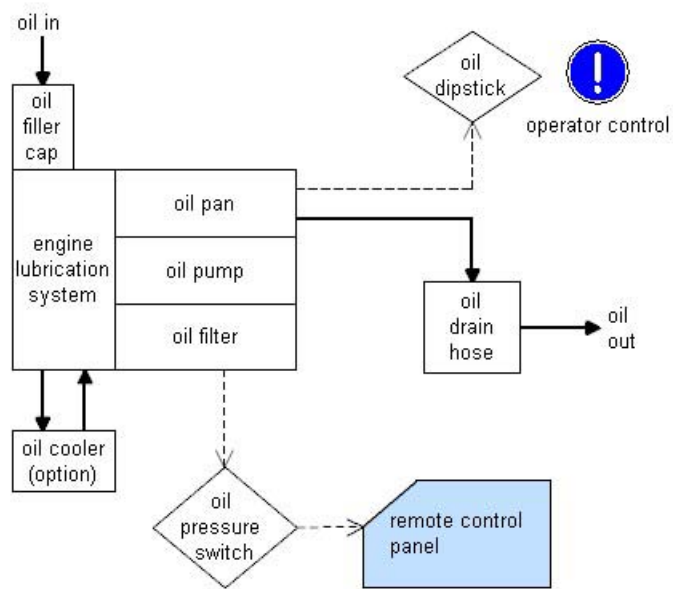
In order to be able to monitor the lubricating oil system, an oil pressure switch is built into the system. The oil pressure switch is on the back of the engine (before the electrical starter).

*Fig. 4.3.5-4: Oil pressure switch*



### 4.3.6 The oil circuit - Schema

Fig. 4.3.6-1: The oil circuit - Schema



Leere Seite / Intentionally blank

## 5. Installation Instructions

**All connections (hoses, wires etc) and installation instructions are designed and suited for “standard” installation situations.**

**Attention!**



In situations where Fischer Panda has no detailed information concerning certain installation requirements (such as vehicle specifications, maximum vehicle speed -and all other conditions concerning special operating situations) the installation instructions should be used as an example guide only.

The installation must be undertaken and proved by a suitable qualified/trained person and may in accordance with the law as required by the country and special situation.

Damages caused by faulty or incorrect installation are not covered by the warranty.

### 5.1 Personal requirements

The described installation must be done by a technical trained person or a Fischer Panda service point.

#### 5.1.1 Hazard notes for the installation

see “Safety first!” on Page 12.

*Follow the general safety instruction at the front of this manual.*

**Notice!:**



**Danger for life! Working at a running generator can result in severe personal injury.**

**DANGER: Automatic start-up**



The generator can be equipped with a automatic start device. This means, an external signal may trigger an automatic start-up. To avoid an unexpected starting of the generator, the starter battery must be disconnected before working at the generator.

**Improper installation can result in severe personal injuries or material damage.**

**Warning!: Risk of injury**



- Always undertake installation work when the generator is switched off.
- Ensure there is sufficient installation clearance before start working.
- Ensure tidiness and cleanliness at the workplace. Loose components and tools lying around or on top of each other are sources of accidents.
- Only perform installation work using commercially available tools and special tools. incorrect or damaged tools can result injuries.

**Oil and fuel vapours can ignite on contact with ignition sources. Therefore:**

- No open flames during work on the generator.
- Do not smoke.
- Remove oil and fuel residues from the generator and floor.

**Contact with engine oil, antifreeze and fuel can result in damage to health. Therefore:**

- Avoid skin contact with engine oil, fuel and antifreeze.
- Remove oil and fuel splashes and antifreeze from the skin immediately.
- Do not inhale oil and fuel vapours.

**Danger for Life. Improper handling, operation, installation and maintenance can result in severe personal injury and/or material damage.**

*Electrical voltages above 48 volts (battery chargers greater than 36 volts) are always dangerous to life). The rules of the respective regional authority must be adhered to. Only an electrician may carry out installation of the electrical connections for safety reasons.*

**Generator, oil and antifreeze can be hot during/after operation. Risk of severe burns.**

**Batteries contain diluted sulphuric acids and bases**

Incorrect use can warm up and burst the batteries. Diluted sulphuric acid / base can escape. Under unfavourable conditions there is a risk of explosion

*Observe the instructions from your battery manufacturer.*

**During Installation/maintenance personal protective equipment is required to minimize the health hazards.**

- Protective clothing
- safety boots
- protective gloves
- Ear defender
- safety glasses

**Disconnect all load during the work at the generator to avoid damages at the load.**

**-Warning!: Danger of fire**



**Danger!: Danger of poisoning**



**ATTENTION!: Danger to Life - High voltage**



**Warning!: Hot surface/material**



**Warning:**



**Instruction!: Personal protective equipment necessary.**



**Attention!: disconnect all load**





## 5.2 Environmental protection

---

---

**Engine liquids/batteries are harmful for the environment. Environmental protection.**

Collect discharged engine liquids and dispose it properly.

Batteries should be disposed properly.



## 5.3 Placement

---

### 5.3.1 General instructions

---

- It is important to pay attention to the fresh air intake.
- Sufficient space must be available below/next to the generator, in order to allow flow of cooling air. (Underside and side: Underneath is not sufficient!)
- The radiator may not be covered.
- Untrained personnel should never open the generator.

### 5.3.2 Preparing the base - Placement

---

Since Panda generators have extremely compact dimensions, they can be installed in tight locations. Attempts are sometimes made to install them in almost inaccessible places. Please consider that even almost maintenance-free machinery must still remain accessible at least at the front (drive belt, water pump) and the service-side (actuator, dipstick). Please also note that in spite of the automatic oil-pressure sensor it is still essential that the oil level has to be checked regularly.

The generator should not be placed in the proximity of light walls or floors, which can have resonance vibrations because of airborne sounds. If this should be unavoidable, then it is recommended that this surface is lined with 1 mm lead foil, which will change the mass and the vibration behaviour.

You should avoid fixing the generator on a slippery surface with little mass (i.e.). This acts as an amplifier of airborne sounds in the most unreasonable case. An improvement can be achieved by reinforcing these surfaces with ribs. In addition, the breakthroughs, which interrupt these surfaces, should be sawed off. The lining of the surrounding walls with a heavy layer (i.e. lead) and foam additionally improve the conditions.

The generator sucks its air from the surrounding engine room. Therefore it must be ensured that sufficient ventilation openings are present, so that the generator cannot overheat.

The Power out of the generator based on the following data:

Ambient temperature: 20°C

Air pressure: 1000mbar (100m above normal Zero)

Rel. air moisture: 30% rel. the ambient temperature

Fuel temperature: bis zu 20°C

Exhaust backpressure: 80mbar (at the exhaust out of the sound isolation cover)

Any differences to this data, for example an ambient temperature of 40°C because of the build inside a machine room/vehicle with a bad ventilation, will cause in a lower Power out (Derating).

### 5.3.3 Advice for optimal sound insulation

---

**The convenient base consists of a stable framework, on which the generator is fastened by means of shockmounts. The combustion air can be sucked in unhindered.**

**Fischer Panda recommend captive shock mount!**

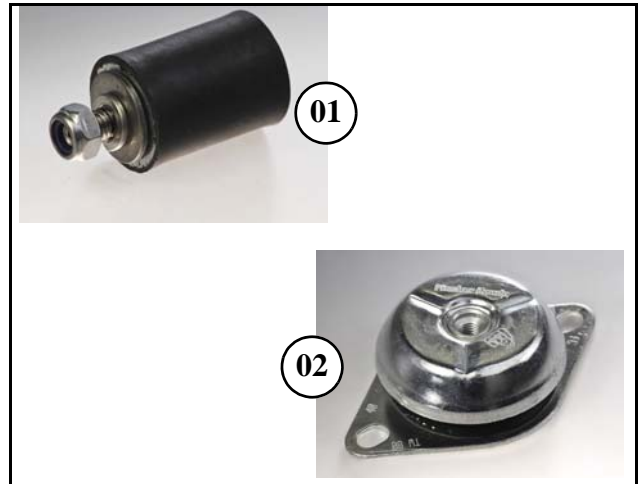
**01. Shock mount**

*representative picture*

**02. Captive shock mount**

*representative picture*

Fig. 5.3.3-1: Shock mount



## 5.4 Air suction filter as a source of noise

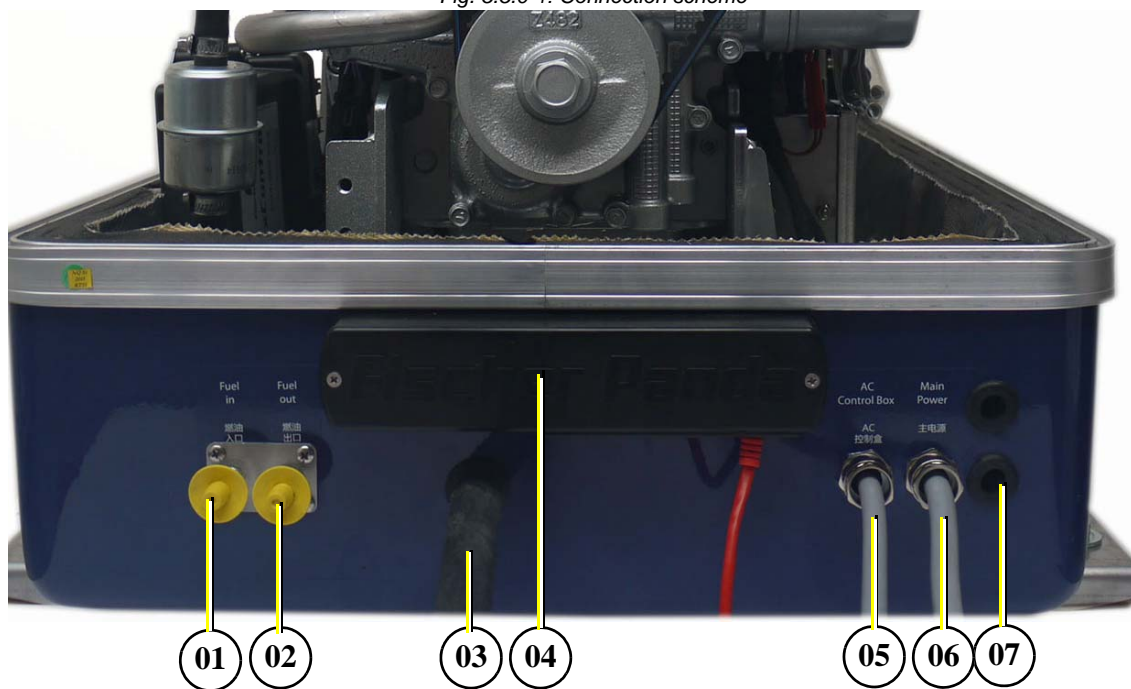
The external suction filter (not included on delivery) must always be used if the generator is to be used in a dust-free environment. This filter is connected by means of a hose with a connecting piece to the generator housing. The filter can be the source of considerable noise. If this is the case, an air intake muffler with the appropriate nominal width should be ordered from Fischer Panda. This is a cylinder, which takes up relatively large amount of room (Total length approx 700mm, Diameter 100mm).

## 5.5 Generator Connections

The position of the connections can differ, depending on the generator type. The appropriate cables and connections are described at the generator.

**The electrical connections MUST be carried out according to the respective valid regulations. This also concerns used cable materials. The cable supplied is meant for laying „protected“ (i.e. in pipe) at a temperature up to a max of 70 ° C (160 ° F). The on-board circuit must also be fitted with all essential fuses.**

Fig. 5.5.0-1: Connection scheme



- 01. Connection fuel IN
- 02. Connection fuel OUT
- 03. Oil drain hose
- 04. xControl connection panel

- 05. Cable for AC-Control box (not all models)
- 06. Load
- 07. Passage for starter battery cable positive (+) and negativ (-)

## 5.6 Fuel system installation

### 5.6.0.1 The following items need to be installed:

- Fuel supply pump (DC)
- Pre-filter with water separator (not part of the delivery)
- Fine particle fuel filter

- Return fuel line to fuel tank (unpressurized)

The external Fuel pump should be installed near the tank

**Electrical fuel pump**

With the Fischer Panda generator is usually supplied an external, electrical fuel pump (DC). The fuel pump must be installed close at the fuel tank. The electrical connections is prepared at the generator.

Some generators (f.e. with Deutz diesel engine) has an engine driven internal fuel pump. At these generators the electrical fuel pump is optional.

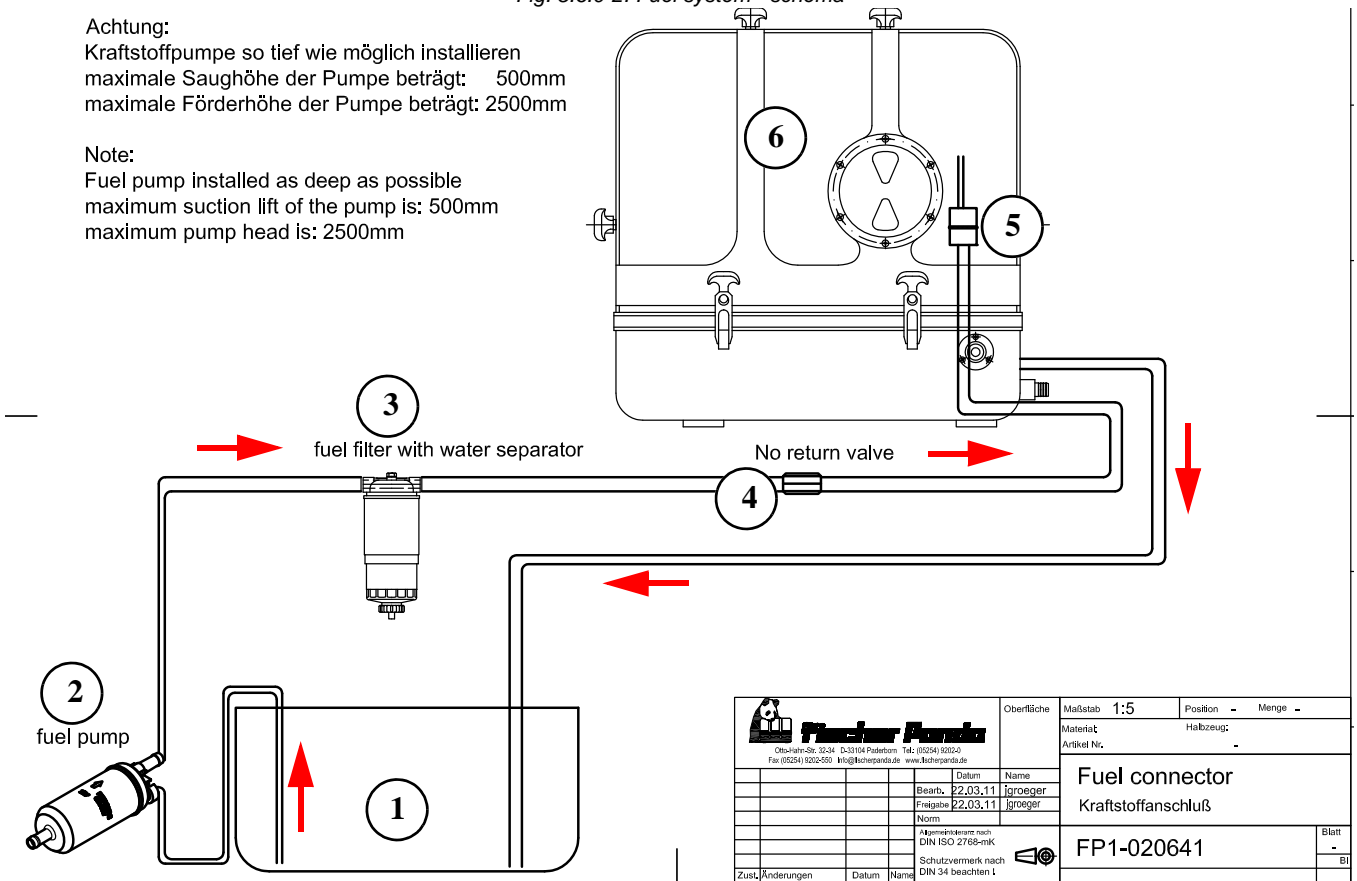
Fig. 5.6.0-1: electrical fuel pump



Fig. 5.6.0-2: Fuel system - schema


Achtung:  
Kraftstoffpumpe so tief wie möglich installieren  
maximale Saughöhe der Pumpe beträgt: 500mm  
maximale Förderhöhe der Pumpe beträgt: 2500mm

Note:  
Fuel pump installed as deep as possible  
maximum suction lift of the pump is: 500mm  
maximum pump head is: 2500mm



- 1. Fuel tank
- 2. external fuel pump
- 3. external fuel prefilter with water separator

- 4. Non return valve
- 5. Fuel fine filter
- 6. Generator

 Oberfläcche Material Artikel Nr.		Maßstab 1:5	Position -	Menge -
		Halbzeug		
Datum Name Bearb. 22.03.11 jgroeger Freigabe 22.03.11 jgroeger Norm Allgemeine Anmerkung nach DIN ISO 2768-mK Schutzvermerk nach DIN 34 beachten!		Fuel connector		
		Kraftstoffanschluß		
Zust. Änderungen Datum Name		FP1-020641	Blatt -	Bl

### External fine filter

At generators with Kubota EA 300 or Farymann engines, the fine filter is delivered with the generator. This fine filter should be installed in the fuel feed line next to the generator.

*representative picture*

Fig. 5.6-3: externer Feinfilter



## 5.6.1 Connection of the fuel lines at the tank

General fuel feed and return line must be connected to the tank at separate connection points.

**Note:**



### Connection of the return pipe to the tank

The return pipe connected to the tank must be dropped to the same depth as the suction pipe, if the generator is mounted higher than the tank, in order to prevent fuel running back into the tank after the motor has been switched off, which can lead to enormous problems, if the generator is switched off for a long period.

### Non-return valve in the suction pipe

A non-return valve must be fitted to the suction pipe, which prevents the fuel flowing back after the generator has been switched off, if it is not possible to use the return flow pipe as a submerge pipe placed in the tank. The instructions „Bleeding Air from the Fuel System“ must be read after initial operation or after it has stood still for a long period, in order to preserve the starter battery.

### Non-return valve for the fuel return pipe

**If the fuel tank should be installed over the level of the generator (e.g. daily tank), then a non-return valve must be installed into the fuel return pipe to guarantee that through the return pipe no fuel is led into the injection pump.**

**ATTENTION!**



## 5.6.2 Position of the pre-filter with water separator

Inside the generator capsule itself, there is the fuel filter installed (exception: Panda 4500). Additional fuel filters (with water separator) must be mounted outside the capsule in easily accessible places in the fuel lines between the tank intake fuel pump and the diesel motor's fuel pump.

**Additionally to the standard fine filter a pre-filter with water separator must be installed outside of the sound insulation capsule in the fuel system line (not included in the delivery).**

*representative picture*

Fig. 5.6.2-1: Pre-filter with water separator



## 5.7 Ventilating the Fuel System

Normally, the fuel system is designed to ventilate air itself i.e. as soon as the electric starter motor starts operation the fuel pump starts working and the fuel system will be de-aerated after some time automatically. It is nevertheless essential to ventilate the system as follows prior to the first operation (as all hoses are empty):

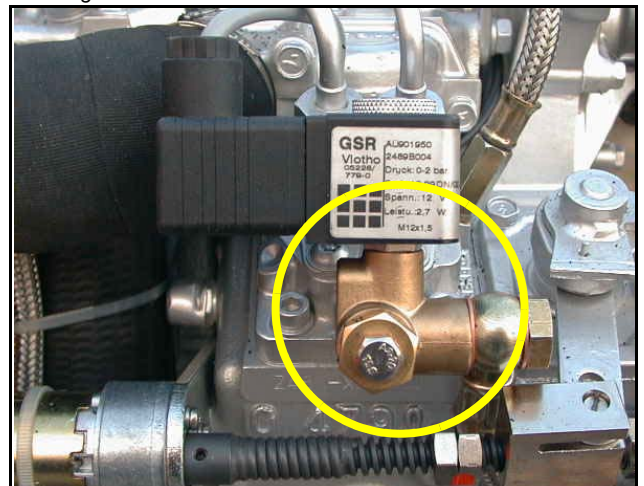
1. Press switch „ON“. All functional elements must light up.
2. Press failure bypass switch and keep firmly pressed. The electrical fuel pump must be audible. Switching on and off the solenoid valve at the generator will be audible by pressing the failure bypass switch (if capsule removed). Pressing the failure bypass switch for approx 3 - 4 minutes will loosen the ventilation screw located at the fuel solenoid valve. The button must continue to be pressed, whilst opening the screw. A large cloth or Kleenex tissue must be laid beneath the connection to prevent escaping fuel running into the capsule. If the fuel runs out without air bubbles, then the ventilation screw can be closed. Only then may the button be released.
3. Pressing the starter button can now start the machine. The machine should start after a short period. If this does not occur, then a connecting nut fitted to the injection line must be loosened and starting procedure repeated. Retighten the washers after successfully starting!

### Ventilation screw at the fuel solenoid valve

Not all generator models are equipped with a fuel solenoid valve. At generators without a fuel solenoid valve, a single ventilation screw is installed.

Sample picture

Fig. 5.7.0-1: Ventilation screw at the fuel solenoid valve



## 5.8 Installation of the cooling system

### 5.8.1 The cooling system / general instructions

The Fischer Panda vehicle generator is delivered without a radiator, with the exception of generators with permanently installed radiators such as the PVK-UK or the PSC series.

Depending on the purpose and installation situation, a wide variety of Fischer Panda radiators are available for the optimum customization of the system. Operation with a commercially available vehicle radiator is possible. The corresponding dimensioning must be implemented by the installer.

**For generators with a permanently installed radiator (e.g. PVK-UK series), the radiator dimensioning and the installation are not necessary.** **Note:**



## 5.9 Radiator baseplate

The radiator baseplate shall be dimensioned in accordance with the purpose. The corresponding checks and entries in the vehicle papers shall be implemented by the operator.

### 5.9.1 Determining the size of the radiator

---

The size of the radiator must be dimensioned in accordance with the total thermal load, the operating conditions, and the installation situation.

**In principle, the thermal load of the generator equals 1.8 times the electrical rated power (1.8 times with a water-cooled silencer, 1.2 times with a dry silencer) in kW. This means that e.g. a Panda 12000 PVMV-N generator with a rated power of 10 kW has a thermal load of 18 kW.** **Note:**



**The radiator must always be dimensioned taking into account a safety margin adjusted for the operating conditions. Undersized radiators will result in an emergency shut-down. This may damage other equipment that is connected to them.**

**Warning: Include safety margin in the calculation.**



### 5.9.2 Radiator design

---

The radiator consists in 3 main components:

1. Radiator. Depending on the version, includes an integrated expansion tank or an external expansion tank.
2. Fan. Depending on the generator, as a DC fan (e.g. 12 V-24 V) or as an AC fan (e.g. 230 V 50 Hz) with respective input voltage.
3. Cover (optional).

### 5.9.3 Radiator types

---

In principle, the following radiator types are differentiated.

1. Flange-mounted radiator for installation on top of, on the side of, or under the vehicle - Siehe "Installation location for radiators for roof, side, or underfloor mounting on the vehicle" auf Seite 57.
2. Built-in radiator for installation in the vehicle wall or cabin wall - Siehe "Installation location for radiator in the vehicle wall or cabin wall" auf Seite 61.
3. Permanently installed radiators for the PVK-UK series
4. Permanently installed radiators for the PSC series for operation inside containers or for tunnel installation - Siehe "Installation location for radiator in a tunnel" auf Seite 62.

The radiator must be installed away from the generator in a well ventilated area. In doing so, it must be ensured that the air outflow of the radiator is completely uninhibited. Turbulence and thermal short-circuiting must be avoided.

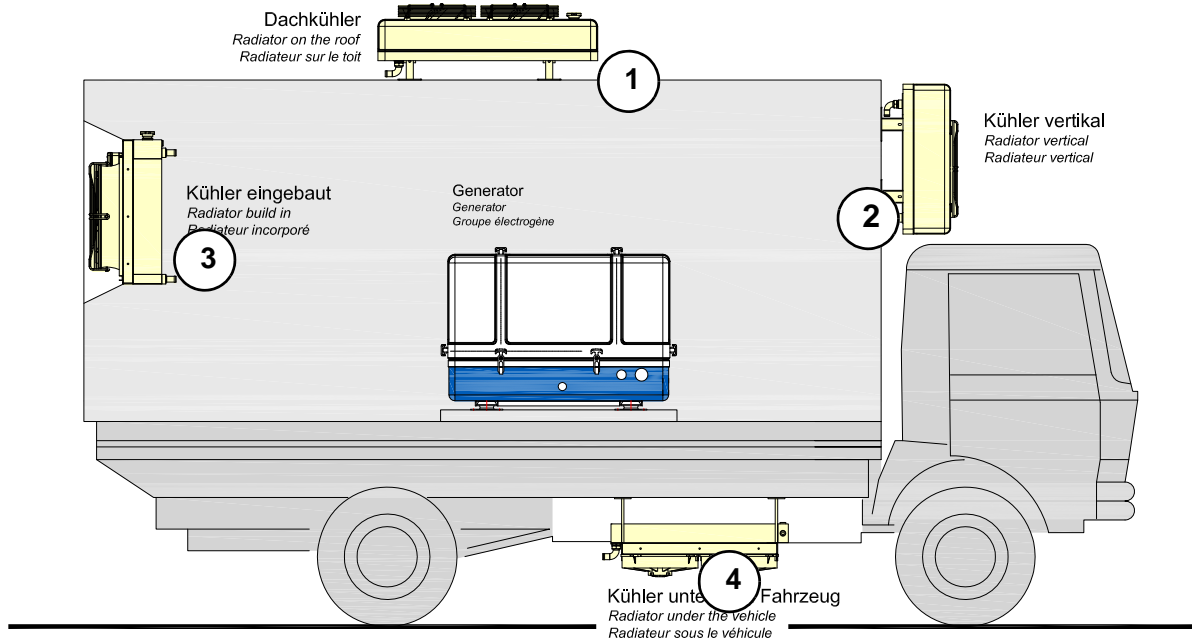
The radiator can be installed in a vertical or a horizontal position. It must be taken into account that the air intake is located above the fan motor.

The best results will be achieved if the radiator can be mounted horizontally on the vehicle roof.



### 5.9.3.1 Installation location for radiators for roof, side, or underfloor mounting on the vehicle

Fig. 5.9.3-1: Radiator installation - example



#### Panda PVMV-N

mögl. Positionen des externen Kühlers

Possible positioning of the external radiator  
Positions possibles de radiateurs externes

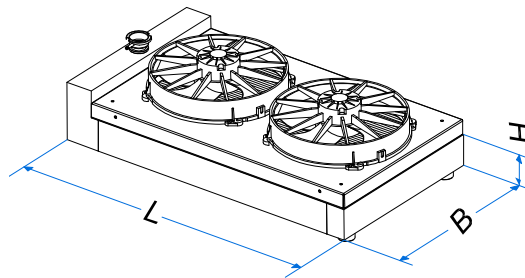


Otto-Hahn-Str. 32-34 D-33104 Paderborn Tel.: (05254) 9202-0  
fax (05254) 9202-92 Info@fischerpanda.de www.fischerpanda.de

WG.1087e00

- |  |   |
|--|---|
| 1. Radiator mounted on the roof          | 3. Radiator build into the vehicle wall |
| 2. Radiator mounted in vertical position | 4. Radiator mounted under the vehicle   |

Fig. 5.9.3.1-2: Radiator dimensions



### 5.9.3.2 Roof installation

**Please note:**

- Minimum distance to vehicle roof: 100 mm.
- Minimum distance to next vertical wall: 1/2 radiator width.
- Min. distance to gas exhaust (heat and dirt source): 500 mm.
- The max. permissible vehicle height must not be exceeded.
- Install warnings stating new vehicle height inside driver's cab.
- During operation, the exhaust flow must be uninhibited for at least 3 meters.



Fig. 5.9.3.2-1: Schematic: radiator, roof installation

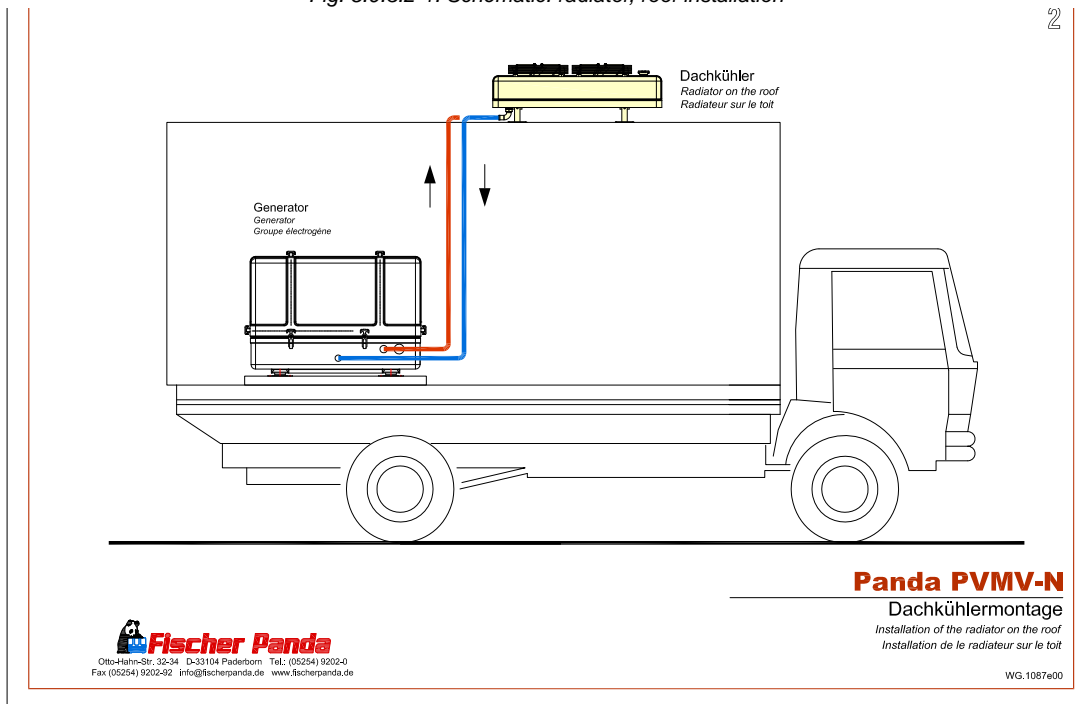
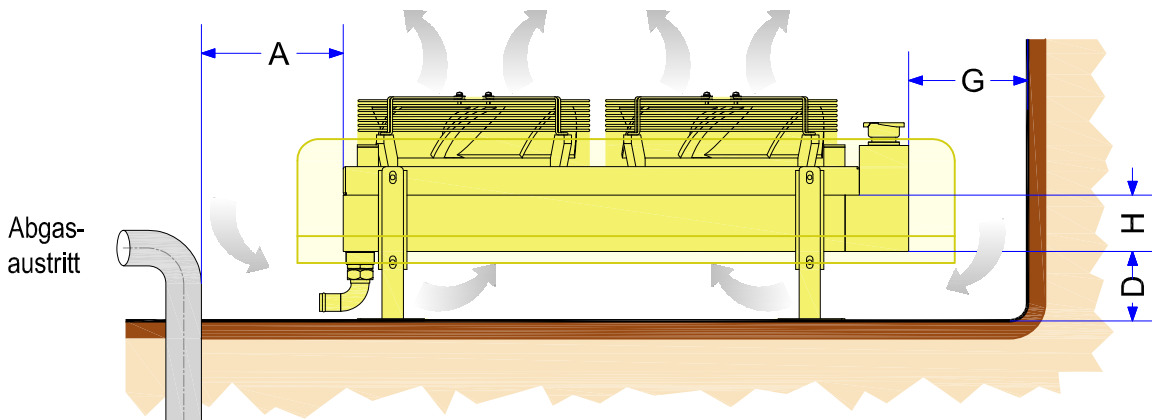


Fig. 5.9.3.2-2: Schematic: radiator, roof installation

**Dachkühler**  
Radiator on the roof  
Radiateur sur le toit

A = mind. 500 mm  
D = mind. 100 mm  
G = mind. 1/2 B  
Freies Abblasen muß gewährleistet sein



### 5.9.3.3 Installation on the vehicle wall

**Please note:**

- Minimum distance to vehicle wall: 100 mm.
- Min. distance to gas exhaust (heat and dirt source): 500 mm.
- The max. permissible vehicle length or width must not be exceeded.
- During operation, the exhaust flow must be uninhibited for at least 3 meters.

Fig. 5.9.3.3-1: Schematic: radiator, vehicle wall installation

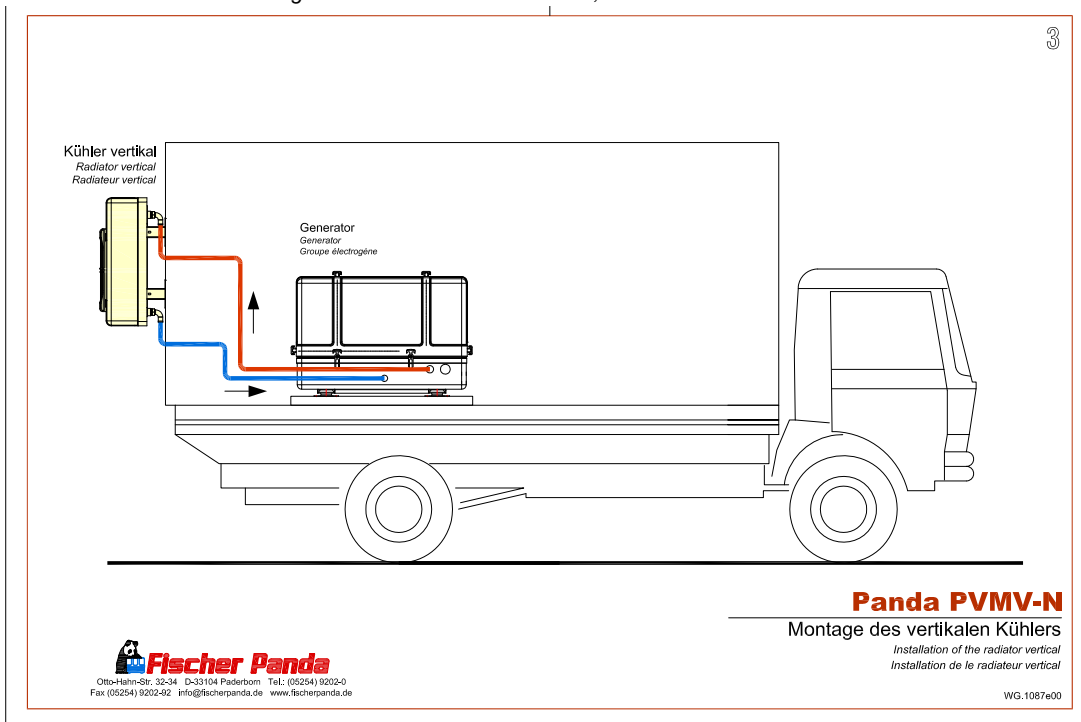
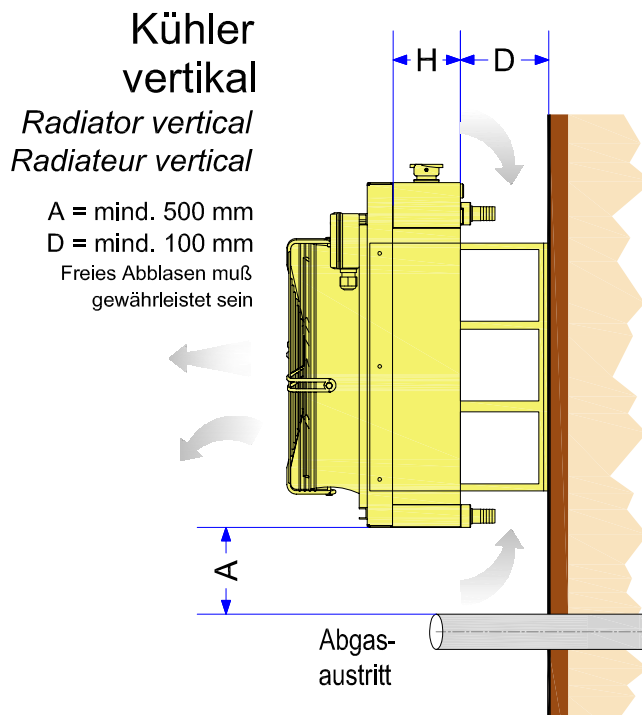


Fig. 5.9.3.3-2: Schematic: radiator, vehicle wall installation



### 5.9.3.4 Underfloor installation of radiator

**Please note:**

- Minimum distance to vehicle floor: 100 mm.
- Minimum distance to ground: 1/2 radiator width
- Min. distance to gas exhaust (heat and dirt source): 500 mm.
- The max. permissible vehicle height must not be exceeded.

Fischer Panda does not recommend underfloor installation. The radiator can quickly become dirty. Rock impacts can result in damage to the radiator. The efficiency of the radiator will drop due to thermal short-circuiting. The radiator may have to be dimensioned larger to compensate.

**Note:**

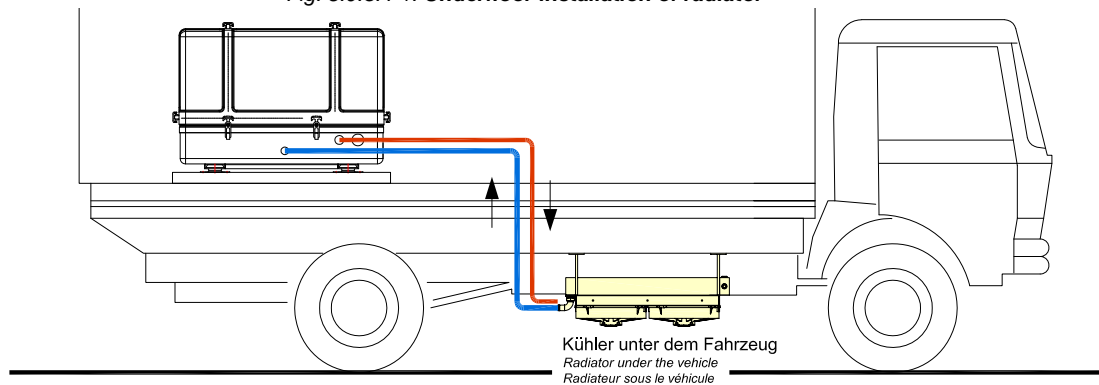


The installation position of the radiator (upside down or not) depends on the airflow direction of the fan. The airflow must be always from the vehicle side through the radiator to the ground.

**Attention:**



Fig. 5.9.3.4-1: Underfloor installation of radiator



**Panda PVMV-N**

Montage des Kühlers unter dem Fahrzeug

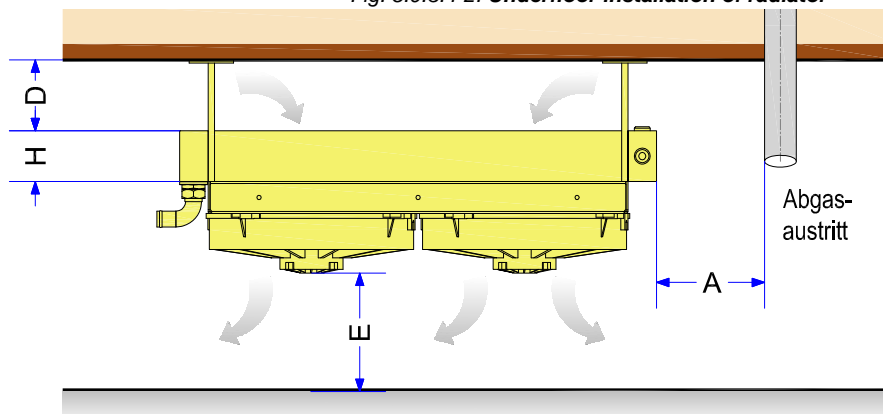
Installation of the radiator under the vehicle  
Installation de le radiateur sous le véhicule



**Fischer Panda**  
Olts-Hattn-Str. 32-34 D-33104 Paderborn Tel.: (05254) 9202-0  
Fax (05254) 9202-92 Info@fischerpanda.de www.fischerpanda.de

WG.1087e00

Fig. 5.9.3.4-2: Underfloor installation of radiator



**Kühler unter dem Fahrzeug**  
*Radiator under the vehicle*  
*Radiateur sous le véhicule*

Von FP nicht empfohlen wegen Verschmutzung, Steinschlag und Effektivität (thermischer Kurzschluss) Kühler muß evtl. größer ausgelegt werden.

A = mind. 500 mm  
D = mind. 100 mm (abhängig von L x B)  
E = mind. 1/2 B  
Freies Abblasen muß gewährleistet sein

### 5.9.3.5 Installation location for radiator in the vehicle wall or cabin wall

A cabin installation is achieved if the set-up location is freely accessible during operation and serves as a working space, if applicable.

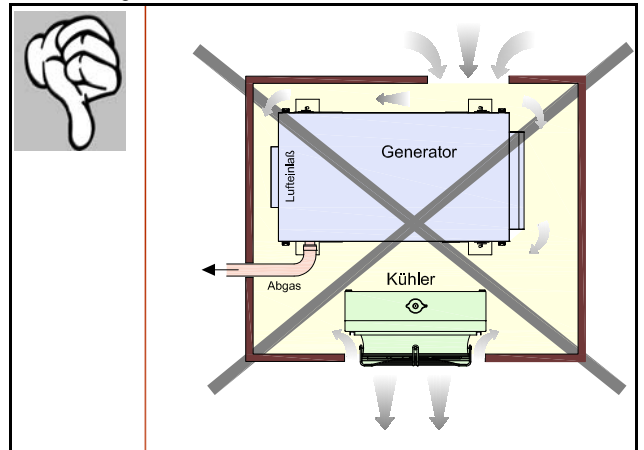
**Please note:**

- If persons are present in the set-up space during operation, a safety circuit must ensure that the air intake is opened.

**Incorrect installation in the cabin**

- Air intake too narrow
- Generator air intake too close to the wall
- Hot air can be taken in next to the radiator
- Exhaust gas line not insulated, heats up combustion air

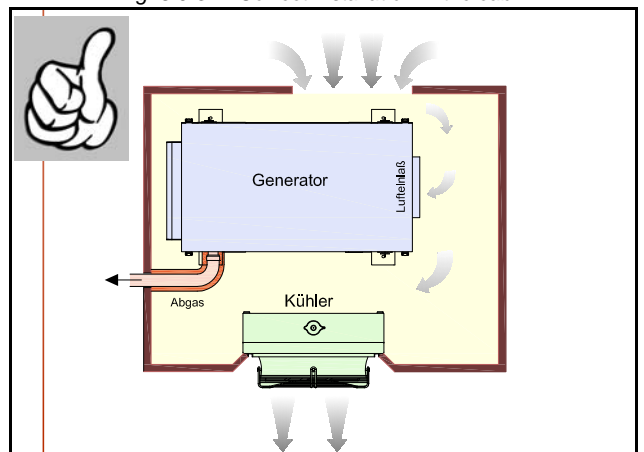
Fig. 5.9.3.5-1: Incorrect installation in the cabin



**Correct installation in the cabin**

- Air intake is min. radiator size (safety grating and decorative grille must be taken into account)
- Uninhibited air intake for generator
- Exhaust flow direction of radiator is shielded and air exhaust enlarged (safety grating and decorative grille were taken into account)
- Exhaust line insulated

Fig. 5.9.3.5-2: Correct installation in the cabin



### 5.9.3.6 Installation location for radiator in a tunnel

A tunnel installation is implemented if the set-up location is separated from the vehicle cab by constructive measures.

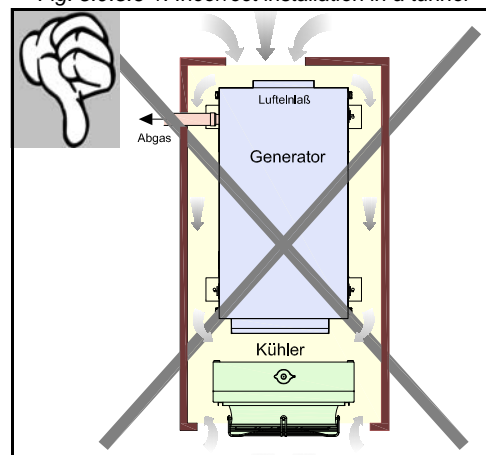
**Please note:**

- The total of the air intakes must be at least equal to the radiator width (
- The total of the cross-sections of the air ducts incl. lateral air intake must be at least equal to the radiator width
- The distance between generator and radiator must equal at least 1/2 the radiator width
- Lateral air supply between generator and radiator can be designed on the side, above, or below

**Incorrect installation in a tunnel**

- Air intake too narrow
- Generator air intake too close to the wall
- Hot air can be taken in next to the radiator
- Exhaust gas line not insulated, heats up combustion air

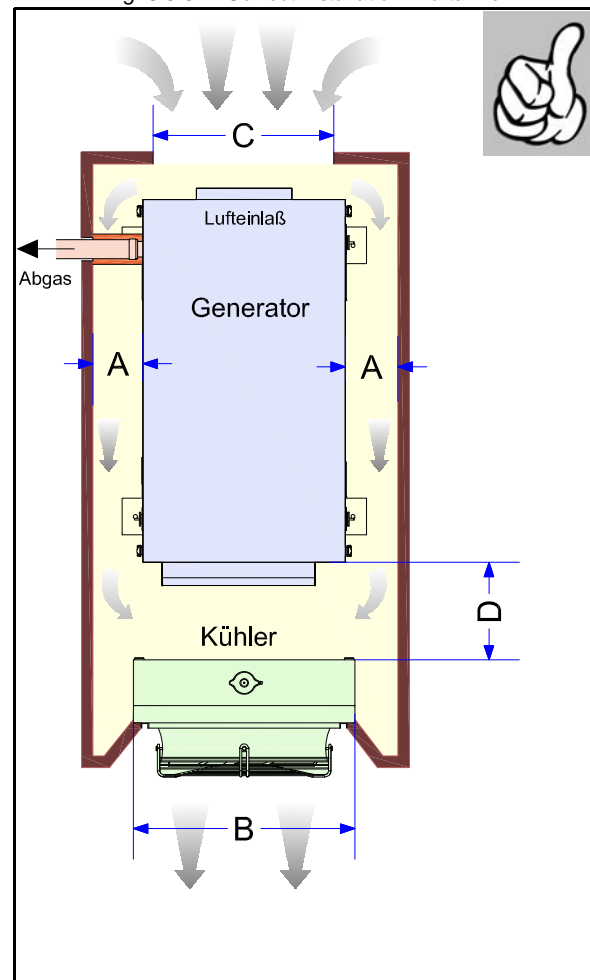
Fig. 5.9.3.6-1: Incorrect installation in a tunnel



**Correct installation in a tunnel**

- Air intake (C) is min. radiator size (B) (safety grating and decorative grille must be taken into account)
- Total of air intakes (A) equals min. the radiator size (B)
- Uninhibited air intake for generator
- Exhaust flow direction of radiator is shielded and air exhaust enlarged (safety grating and decorative grille were taken into account)
- Exhaust line insulated

Fig. 5.9.3-2: Correct installation in a tunnel



### 5.9.3.7 Installation location for generators of the PVK-UK series

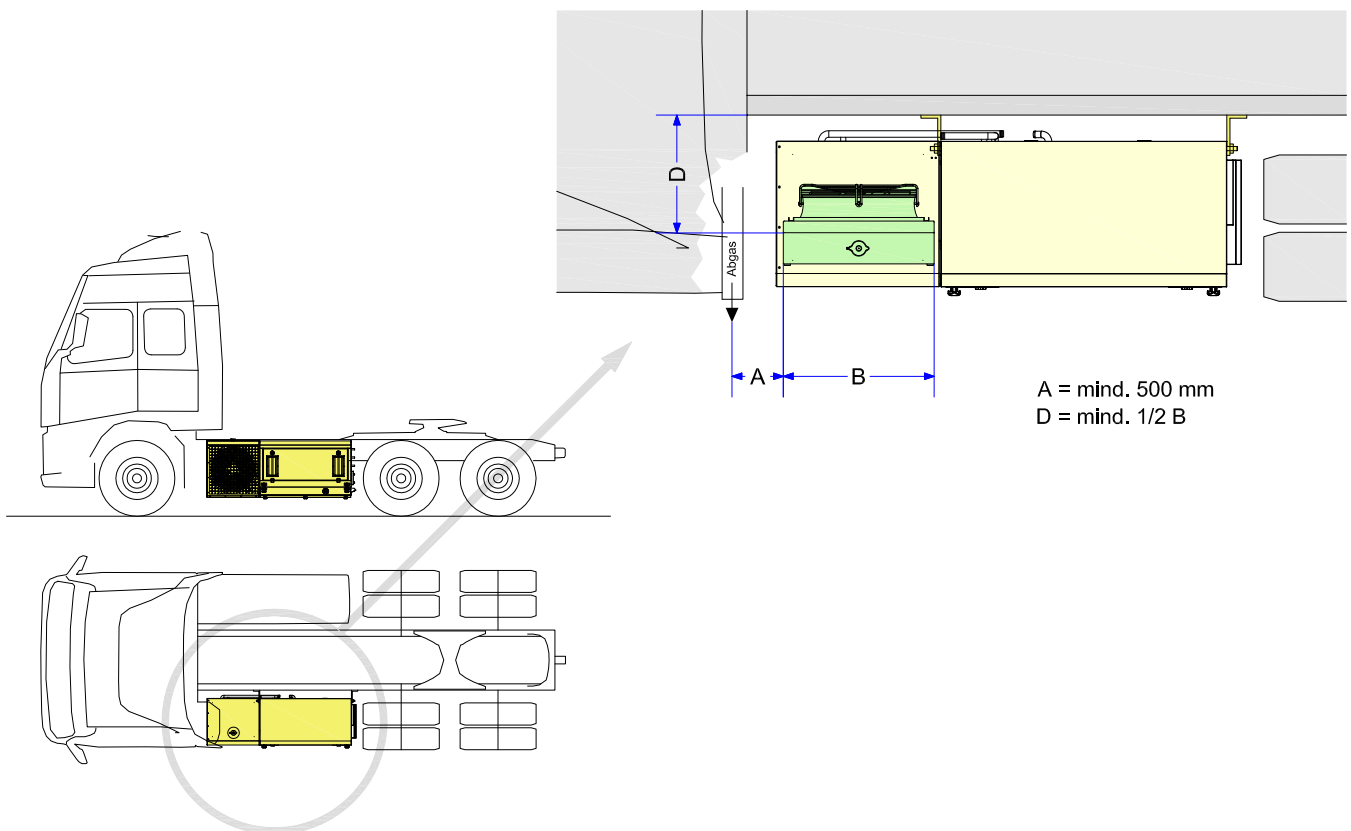
Generators of the PVK-UK series are designed for lateral installation on the vehicle chassis

**Please note:**

- Min. distance between radiator and vehicle chassis must be  $1/2 B$ .
- Min. distance to gas exhaust (heat and dirt source): 500 mm.
- The exhaust flow area must be unobstructed. No impairment to the vehicle chassis or installations.

Fig. 5.9.3.7-1: PVK-UK installation location

Ansicht von oben



### 5.9.4 Coolant hoses

- The diameter of the coolant hoses must be equal to or greater than the diameter of the generator connections.
- A vacuum-tight and temperature resistant hose (min. 120 °C) must be used.
- The hoses must be pressure resistant under vacuum conditions.
- Depending on the application location, the hoses must be UV resistant.
- The hoses must be weather resistant and chemical resistant (resistant to oil, etc.).
- The bending radii of the hose type shall be taken into account.
- The hoses must have a general operating permit (ABE) / approval certificate.

### 5.9.5 Connection of the external radiator

see Kapitel 5.11, "Installation schematics," auf Seite 67

### 5.9.6 Coolant expansion tank

---

#### Coolant expansion tank for systems with a radiator below the generator.

For operation, a coolant expansion tank must be installed at least 100 mm above the level of the exhaust manifold and the radiator.

The ventilation line of the radiator and the generator shall be installed on the top connection. The bottom connection is used to refill the coolant circuit and is integrated in the coolant circuit at a low-lying location using a T-fitting.

The coolant expansion tank can be procured from the Fischer Panda accessories.

#### Coolant expansion tank for systems with a radiator installed above the generator.

If the radiator is installed min. 100 mm above the exhaust manifold, a radiator with integrated coolant expansion tank can be used. In this case, the ventilation line of the generator is connected to the return line to the radiator (hot side) using a T-fitting. It is refilled via the feed line (cold side) to the generator.

### 5.9.7 Installation of a coolant temperature indicator

---

Where sensitive systems are installed (e.g. in television transmission vehicles, rescue vehicles, or other vehicles with sensitive metrological installations) a remote indicator for coolant temperatures should be installed. It is, however, highly recommended to install two indicator instruments:

1. coolant feed line (cold side)
2. coolant return line (hot side)

The exact location of the measuring unit is not important, here.

**A corresponding indicator kit can be procured from Fischer Panda.**

**Note:**



For subsequent installation, Fischer Panda T-fittings are available for hose elements in which the temperature sensors are then installed.

### 5.9.8 Permissible coolant temperatures

---

- The radiator must be dimensioned such that the feed line to the generator (cold side) does not get hotter than 70 °C during normal operation. The coolant feed line must be connected to the coolant pump.
- The coolant volume flow must be dimensioned such that the temperature difference between engine inflow (coolant pump) and engine outflow (exhaust manifold) is no greater than 12 K under full load.

To ensure this, the coolant hoses shall be routed without kinks or sharp bends. Resistance, e.g. due to narrowed points in transition pieces or shut-off valves, shall be avoided.

**Note:**



### 5.9.9 Coolant pump

---

- The generator is equipped with a normally suctioning (not self-priming) coolant pump.
- The coolant pump is designed so that a max. distance of 5 m between pump and radiator is possible.

If the necessary coolant volume flow is not achieved (e.g. due to a special installation situation), an external coolant pump with the corresponding output must be installed in the coolant circuit to increase the coolant volume flow.

**Note:**





The pressure in the coolant circuit must not exceed 0.7 bar!

Warning:



Required coolant volume flow:

Fig. 5.9.9-1: Coolant volume flow

Generator type	Coolant volume flow
Panda 4500	min. approx. 10 L/min
Panda 8000 - 10000	approx. 16 to 22 L/min
Panda 12000 - 15000	approx. 24 to 28 L/min
Panda 18 - 24	approx. 32 to 38 L/min
Panda 30 - 32	approx. 40 to 45 L/min
Panda 42 - 65	approx. 50 to 60 L/min

### 5.9.10 Radiator fan

---

Radiator fans are wearing parts. To ensure a long service life, there must be no objects impairing or blocking the free movement of the fan during operation. Such objects include:

- Snow
- Ice
- Leaves
- Branches
- Increased air resistance due to dirty radiator

### 5.9.11 Anti-freeze and corrosion protection

---

At the factory, the coolant is adjusted to a 50% concentration of G48 anti-freeze solution (approx. -40 °C). If lower temperatures are possible during transport or storage, the coolant filling must be drained or adjusted for the lower temperatures.

After draining the coolant, the system must be blown dry with compressed air at 0.5 bar. This will ensure that the system is complete drained.

The anti-freeze agent also serves to protect the system against corrosion. The anti-freeze concentration in the coolant must not drop below 30 %.

### 5.9.12 Logging the temperature values during initial start-up

---

It is mandatory to measure the temperature values of the circulating coolant in the circuit after installing the generator for the initial start up. Two remote thermometers must be used for this purpose. One connection must be mounted to the coolant feed line to the engine, the second one on the coolant outfeed. The generator must then be loaded with min. 75 % of the rated power after a brief warm-up phase. The circulation of the coolant must be checked. The values must fall within the following limits:

1. Coolant feed line max. 70 °C in permanent operation mode at maximum load
2. Coolant return line max. 85 °C in permanent operation mode.
3. Differential of the two values: This item is of particular importance and provides information on the circulation of the coolant. The difference should be max. 17 K for a coolant water system with an integrated water-cooled muffler. It should, however, typically be between 10 and 12 K.

If the difference is greater than 15°K, the coolant circulation is not sufficient. The water circulation must then be increased. This can be solved by e.g. improving the line routing, or by reducing the belt pulley diameter. It is absolutely necessary to measure the output of the cooling system after installing the generator. The values given above shall be considered maximum permissible values. They apply to operation in increased temperatures, as well. In permanent operation mode at external temperatures around 20 °C, the values must fall near the lower limit of the tolerance.

**Each manual includes installation certificates, which must be filled in after installation and returned to the manufacturer (copy).**

**Note:**



**Returning the installation certificates and commissioning logs is an important component of the warranty conditions.**

## 5.10 Custom installations

---

The effects on the warranty must be agreed on a case-by-case basis with Fischer Panda.

### 5.10.1 External heat exchangers

---

External heat exchangers shall be installed as per the specifications of the respective manufacturers.

### 5.10.2 External engine pre-heater

---

The external engine pre-heater shall be installed as per the manufacturer's instructions.

This applies to:

- electrical pre-heater systems (e.g. Defa),
- diesel-operated pre-heater systems,
- petrol-operated pre-heater systems.

### 5.10.3 Keel cooling

---

The keel cooling system shall be dimensioned and installed as per the manufacturer's instructions.

## 5.11 Installation schematics

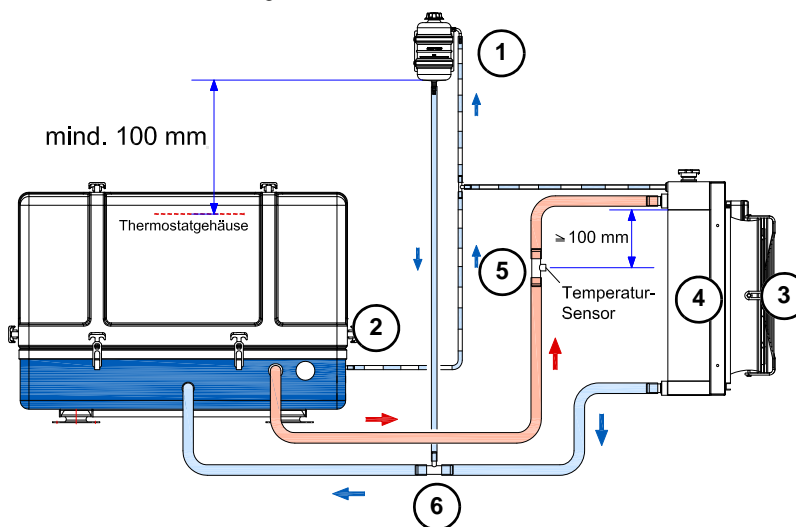
At generators with xControl, the ECU measures the coolant temperature at the exhaust manifold. The external temp switch sensor in the hydraulic lines is not necessary at these generators.

Note:



### 5.11.1 Installation for vertical radiator installation

Fig. 5.11.1-1: Vertical radiator - schematic



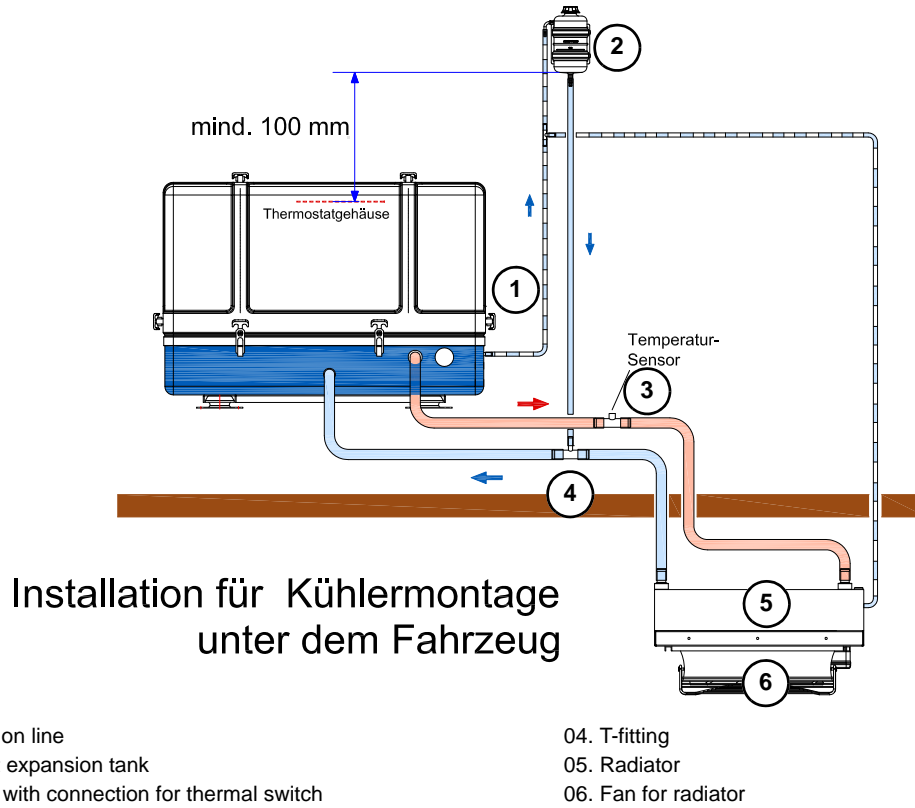
### Installation für vertikale Kühlermontage

- 01. Coolant expansion tank
- 02. Engine bleed line
- 03. Fan for radiator

- 04. Radiator
- 05. Thermal switch (on the hot side)
- 06. T-fitting

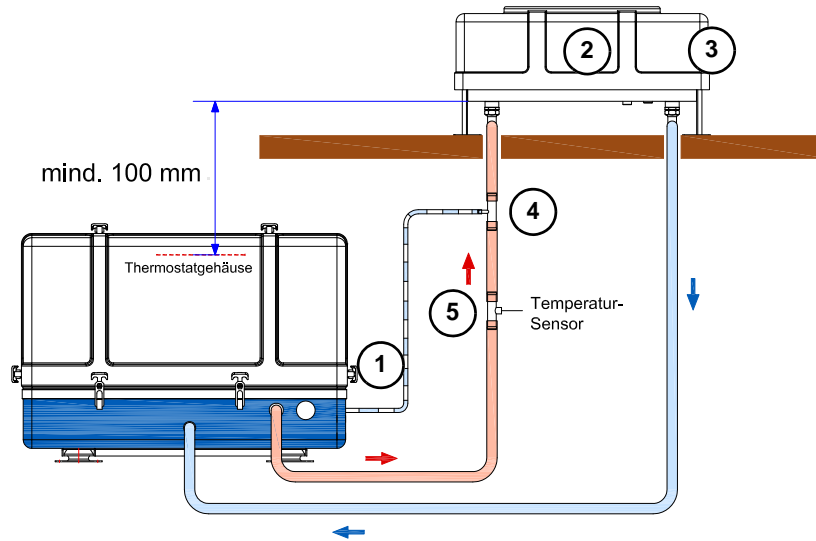
### 5.11.2 Installation for mounting the radiator under the vehicle

Fig. 5.11.2-1: Underfloor radiator - schematic



### 5.11.3 Installation schematic for roof mounted radiator with expansion tank

Fig. 5.11.3-1: Roof-mounted radiator - schematic

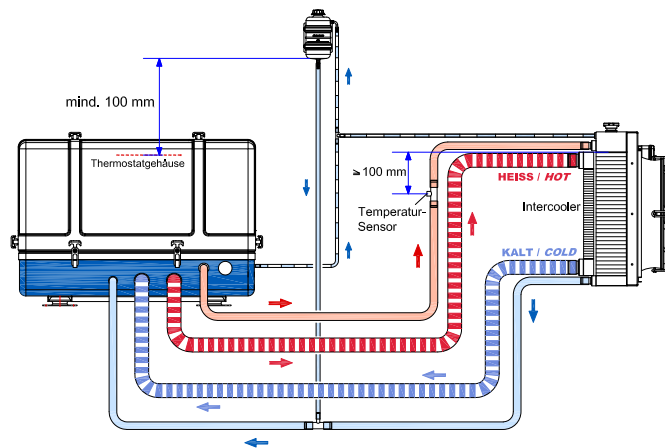


#### Installation für Dachkühlermontage mit integriertem Ausgleichsbehälter

- |  |   |
|--|---|
| 1. Engine bleed line                   | 4. T-fitting for bleed line                     |
| 2. Radiator (horizontal)               | 5. T-fitting with connection for thermal switch |
| 3. Coolant expansion tank (integrated) |   |

### 5.11.4 Installation Radiator with Intercooler -Schematic sample vertical Radiator

Fig. 5.11.4-1: Installation Radiator with Intercooler -Schematic sample vertical Radiator



#### Installation für vertikale Kühlermontage mit Intercooler

**Panda PVMV-N**  
Kühlerinstallation

WG.1087e00

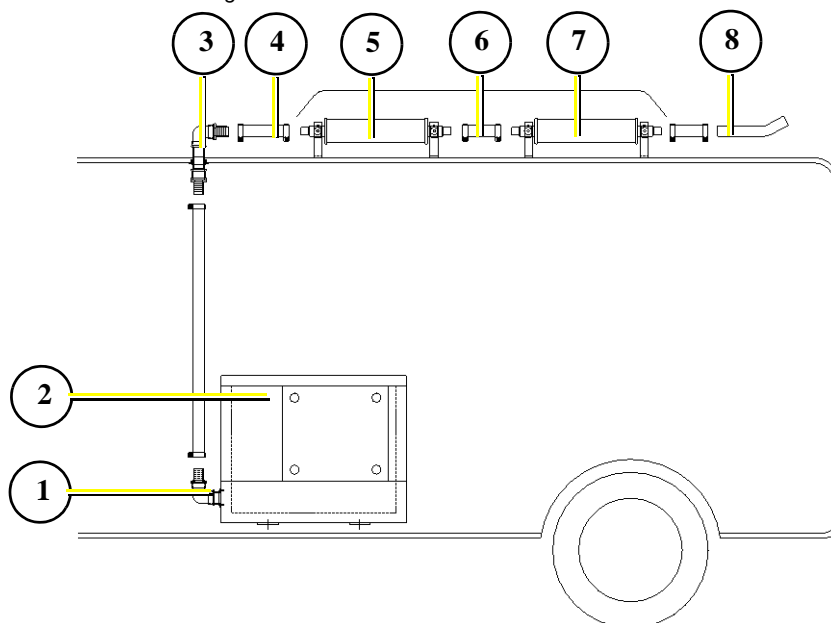
The installation sample must be adapted to the Radiator/ Note:  
System.



## 5.12 Exhaust installation

### 5.12.1 Exhaust connection for roof outlet

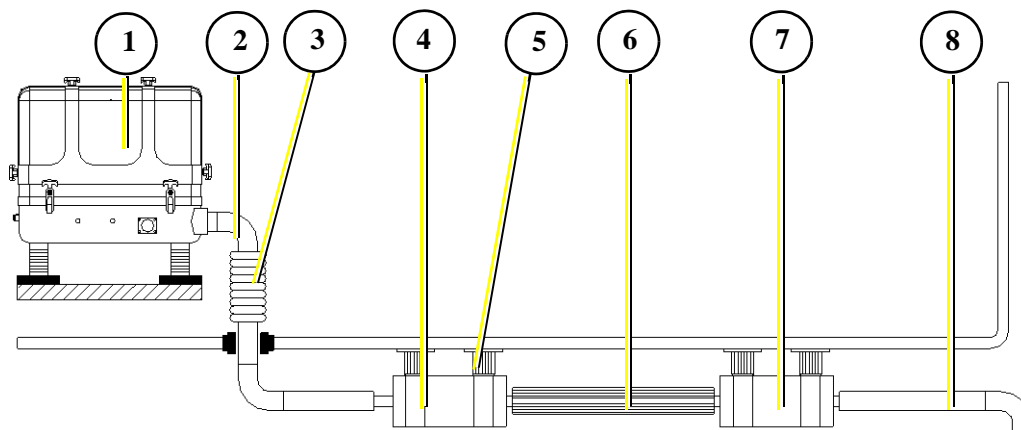
Fig. 5.12.1-1: Exhaust installation - scheme



- |                              |                                      |
|------------------------------|--------------------------------------|
| 1. Exhaust outlet            | 5. External pre-silencer (option)    |
| 2. Generator                 | 6. Exhaust pipe                      |
| 3. Roof through fitting      | 7. External series silencer (option) |
| 4. Vibration damper (option) | 8. End pipe                          |

### 5.12.2 Exhaust connection for mounting below the vehicle

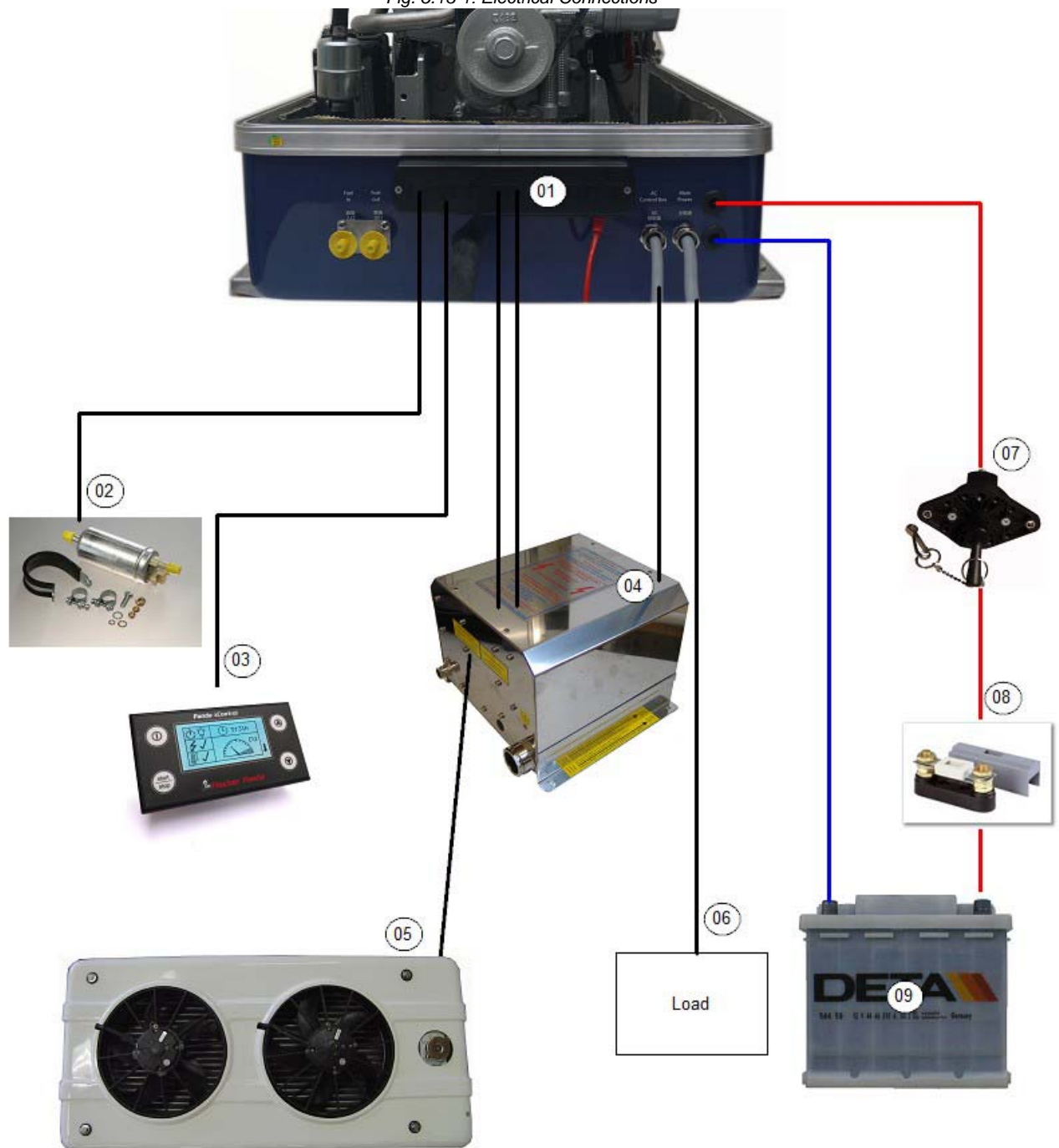
Fig. 5.12.2-1: Exhaust installation - scheme



- |                                   |                                      |
|-----------------------------------|--------------------------------------|
| 1. Generator                      | 5. Vibration damper                  |
| 2. Exhaust outlet                 | 6. Exhaust pipe                      |
| 3. Compensator (option)           | 7. External series silencer (option) |
| 4. External pre-silencer (option) | 8. End pipe                          |

## 5.13 Connection of the Electrical Components

Fig. 5.13-1: Electrical Connections



1. Generator
2. External fuel pump
3. Remote control panel
4. AC control box
5. Radiator with fan

6. Switchboard
7. Battery main switch
8. Battery fuse
9. Starter battery

## 5.14 Generator AC System Installation

---

---

Before the electrical system is installed, READ the SAFETY INSTRUCTIONS of this manual FIRST!

Be sure that all electrical installations (including all safety systems) comply with all required regulations of the regional authorities. This includes lightening conductor, personal protection switch etc.

**Warning!: Electrical Voltage**



## 5.15 AC-Control box

---

---

An AC-Control box is necessary for the operation of Panda generators. According to the generator capacity the AC Control box is variable dimensioned and equipped. It is supplied with a lockable cap.

This cap must necessarily be locked when the generator is running, as at all models during operation, 400 V is present in the AC control box.

For the excitation of the generator all necessary capacitors and the starting current limitation (not available at all models) are stored in the AC Control box. The AC Control box must be connected to the generator with the electrical lines (230 V and 400 V).

**Only qualified personnel may carry out working at the AC Control box.**

**Danger to life - 400V AC**





Fig. 5.15-1: AC-Control box single phase - example

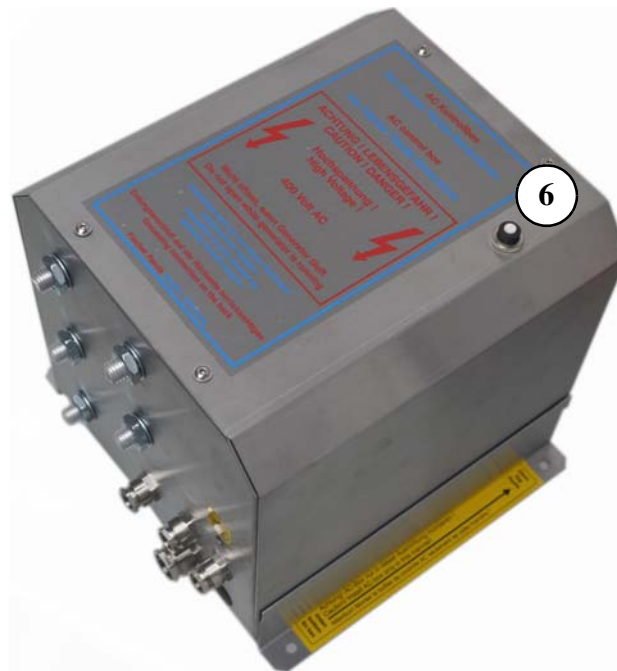
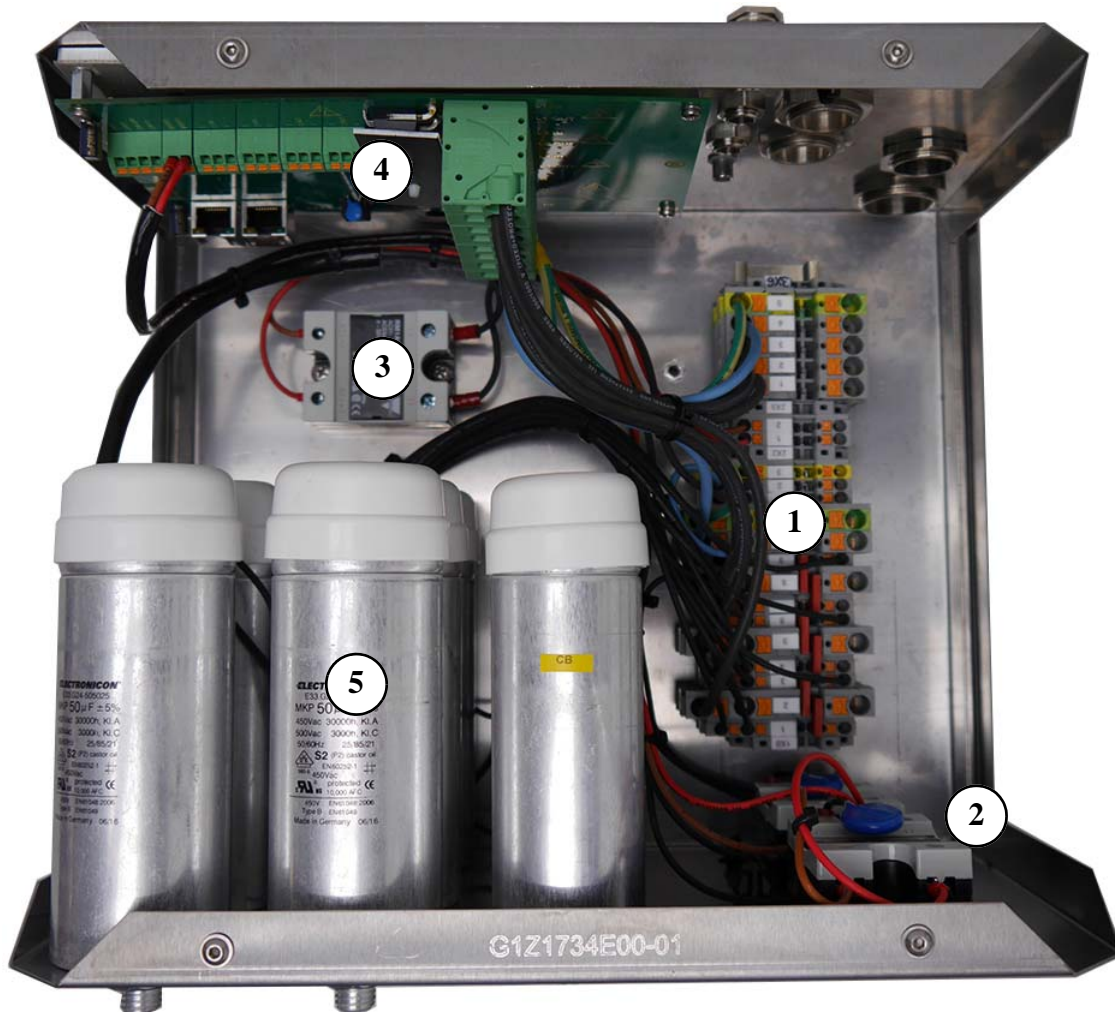


- 1. Terminal block for excitation
- 2. Solenoid for radiator fan
- 3. Boost solenoid

- 4. Capacitors
- 5. Fuse for radiator fan (single phase)



Fig. 5.15-2: AC-Control box three phase - example



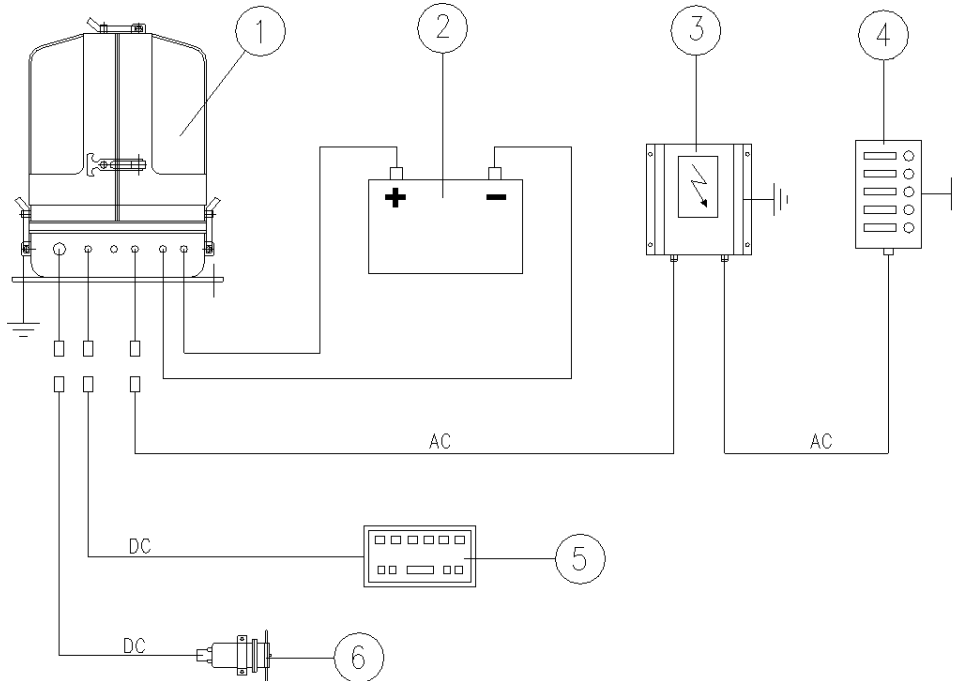
- 1. Terminal block for excitation
- 2. Boost solenoid
- 3. Solenoid for radiator fan

- 4. 3-Phase Current / Voltage measurement module
- 5. Capacitors
- 6. Fuse for radiator fan (single phase)

### 5.15.1 Installation with looped-in AC-Control box

All electrical safety installations have to be made on board (RCD etc.).

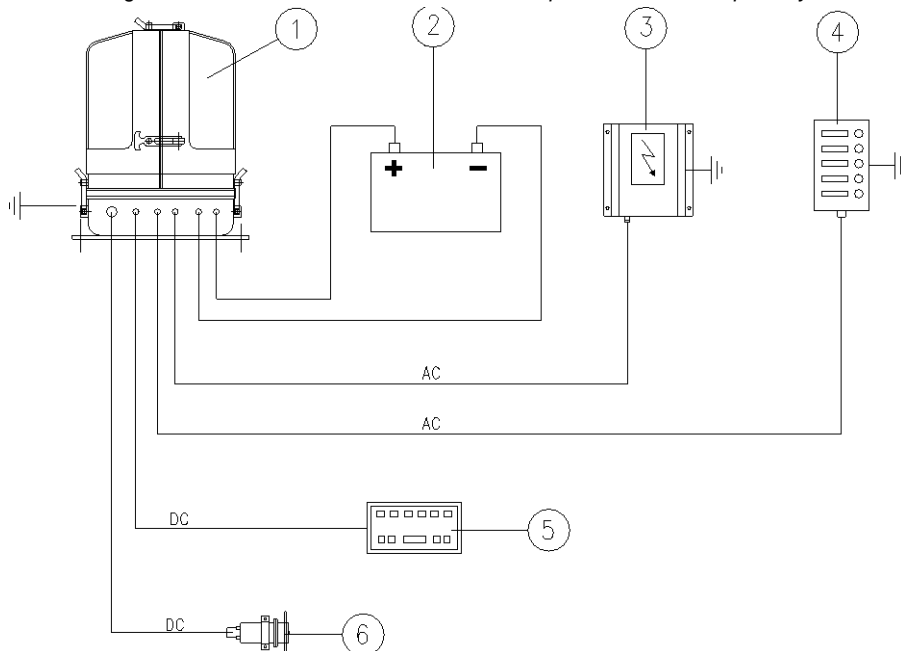
Fig. 5.15.1-1: Installation with looped-in AC Control box



- |                   |                         |
|-------------------|-------------------------|
| 1. Generator      | 4. Distribution panel   |
| 2. Battery        | 5. Remote control panel |
| 3. AC-Control box | 6. Diesel pump          |

### 5.15.2 Installation AC-Box / Distribution panel connected separately

Fig. 5.15.2-1: Installation AC-Box / Distribution panel connected separately



- |                   |                         |
|-------------------|-------------------------|
| 1. Generator      | 4. Distribution panel   |
| 2. Battery        | 5. Remote control panel |
| 3. AC-Control box | 6. Diesel pump          |

### 5.15.3 Electronic voltage control xControl

---

The xControl controls the generator voltage and motor speed. An actuator/servo on the injection pump can increase the engine speed compared to the idle speed.

If the generator runs without load, the frequency should be approx. 48,5 - 49 Hz (50 Hz System) or 58,5 - 59 Hz (60 Hz System). The frequency (equates to the speed) can be increased by up to 8%. This ensures that the engine speed is increased when there is an extra load. The maximum speed is achieved when 80% load is reached.

The speed gauge is governed and limited by an adjusting screw, above and below. Adjustment of this screw may not occur without the expressive approval of the manufacturer.

All signals pass through the circuit board in the xControl box. The signal impulse for the Servo is passed to the electric motor.

### 5.15.4 Connection to the AC on-board power supply

---

#### 5.15.4.1 Protective conductor

The generator is equipped with a PEN protective conductor system as standard. A Neutral and a PE line are separate on the power out cable.

If a separate protective conductor is necessary (i. e. according to national safety regulations), the bridge circuit at the generator and the AC-Control box between neutral and generator housing has to be removed. Afterwards a separate protective conductor has to be installed and connected to all the system's attached metallic housings.

It is recommended to provide a voltage indication (voltmeter) and also a power indication, if applicable, in the installation system. The voltmeter (and power indication, if applicable) has to be installed behind the selector switch so that the voltage for every possible voltage source may be indicated. A separate voltmeter for the generator itself, is therefore not required.

#### 5.15.4.2 Electrical fuse

It is absolutely essential that the electrical system installation is inspected by a qualified electrical technician. The generator should have its own AC input electrical fuse. This fuse should be sized so that the rated current of the generator on each of the individual phases is not exceeded by more than 25%.

Data for gensets with power output greater than 30 kW on request!

The fuses must be of the slow type. A 3-way motor protection switch must be installed to protect the electrical motor.

Required fuse see *section 9.6, "Rated current," on page 141.*

#### 5.15.4.3 Required cable crosssections

The following recommended electrical cable dimensions (cross sections) are the minimum required sizes for a safe installation (see *section 9.7, "Cable cross-section," on page 141*).

## 5.16 Generator DC system installation

---

The Panda generators from 6000 upwards have their own dynamo to charge a DC starter battery.

It is recommended to install an additional starter battery for the generator.

The generator is then independent from the remaining battery set. This enables you to start the genset at any time with its own starter battery even if the other batteries are discharged. A further advantage of a separate starter battery is that it isolates the generator's electric system from the rest of the boat's DC system, i.e. minus pole (-) is not connected electrically to Earth/Ground.

The generator is then Earth/Ground free.

### 5.16.1 Connection of the starter battery block

An own separate starter battery must be installed for the generator.

The positive cable (+) of the battery is attached directly at the solenoid switch of the starter motor. The negative cable (-) of the battery is attached underneath the starter motor at the engine mount.

**Panda Generators Panda 6000 and higher normally provided with an alternator/dynamo to charge the starter battery. At generators without alternator/dynamo it is needed to charge the starter battery with an external battery charger.**

**NOTE:**



**Make sure that the voltage of the starter battery fits to the start system voltage**

**ATTENTION!**



f.e. 12 V starter battery for a 12 V start system

f.e. 24 V starter battery for a 24 V start system (2x12 V batteries in a row)

**To avoid large voltage drops the battery should be installed as near as possible to the generator. The positive terminal of the battery is attached at the red cable, the negative pole at the blue cable.**

**NOTE:**



It must be guaranteed that first the cables are attached at the generator and then at the battery.

**ATTENTION!: Consider correct connection sequence**



#### Battery connection

**ATTENTION!: Right connection of the battery.**

**Wrong connection of the battery bank can cause a short-circuit and fire.**



Install an appropriate fuse and a battery circuit breaker in the plus pole cable of the battery, but with a distance to the battery of up to 300 mm (12 inch) at maximum.

The cable from the battery to the safety device must be secured with protective pipe/sleeve against chafing through.

For the connection use self-extinguishing and fire-protected cables, which are appropriate for temperatures up to 90 °C, 195 °F.

The batteries must be installed in such a way that they do not chafe through or other mechanical load can be stripped.

The battery poles must be secured against unintentional short-circuit.

The positive battery cable within the generator must be shifted in such a way that it is protected against heat and vibrations by appropriate sleeve/protective pipe. It must be shifted in such a way that it does not affect rotary parts or parts, that become hot in operation, e.g. wheel, exhaust elbow union, tail pipe and the engine. Do not lay the cable too tautly, since otherwise it could be damaged.

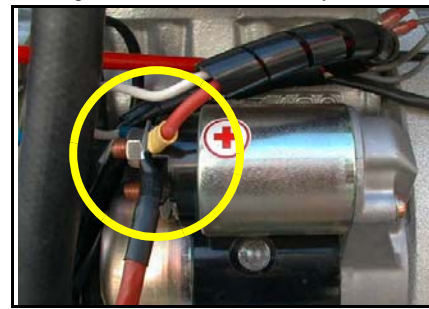
Make a test run after the installation and check the laying of the batteries during the test run and afterwards. If necessary, correct the laying.

Examine regularly the cable laying and the electrical connections.

### Positive battery cable

The positive (+) battery cable is connected directly to the solenoid switch of the starter.

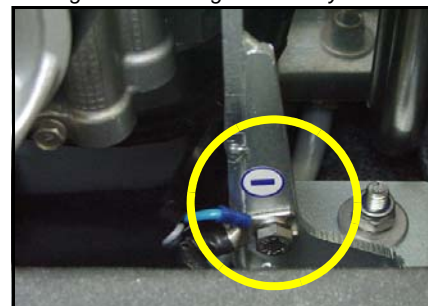
Fig. 5.16.1-1: Positive battery cable



### Negative battery cable

The negative (-) battery cable is connected to the engine foot.

Fig. 5.16.1-2: Negative battery cable



**Note! The battery negative pole may not be connected with the boat ground or with the protective grounding of the 12 V installation!**

### DC starter motor

All Panda generators are equipped with an independent DC starter motor.

1. Solenoid switch for starter motor
2. Starter motor

Fig. 5.16.1-3: DC starter motor

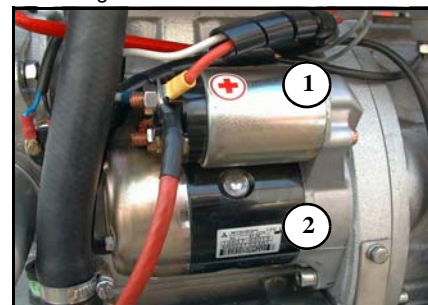
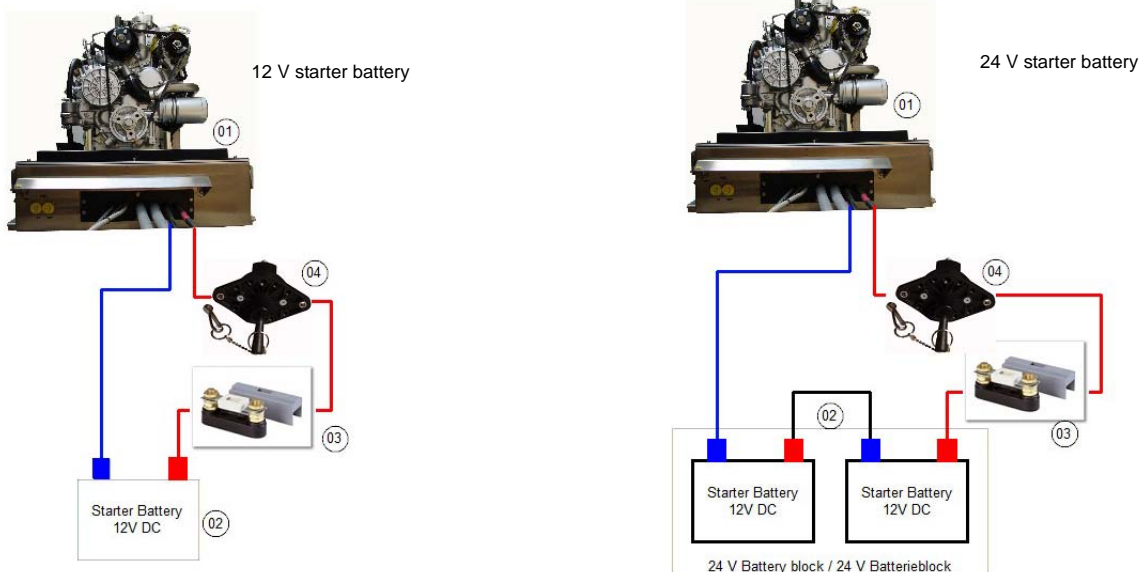


Fig. 5.16.1-4: Connection starter battery - schema



1. Generator
2. Battery block

3. Fuse
4. Battery main switch

### 5.16.2 Connection of the remote control panel - see separate control panel manual

### 5.16.3 Connection Box – Generator xControl – CB-G

The xControl CB-G is the external interface of the generator equipped with a xControl System.

The panel and the fuel pump are connected at this interface. It is optionally possible to connect emergency stop,

auto start, load contactor and boost..

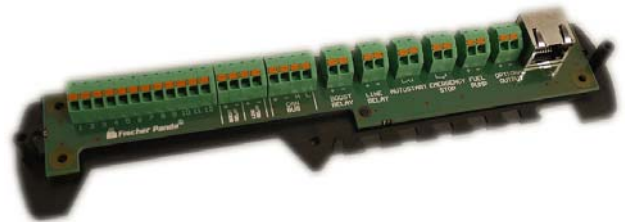
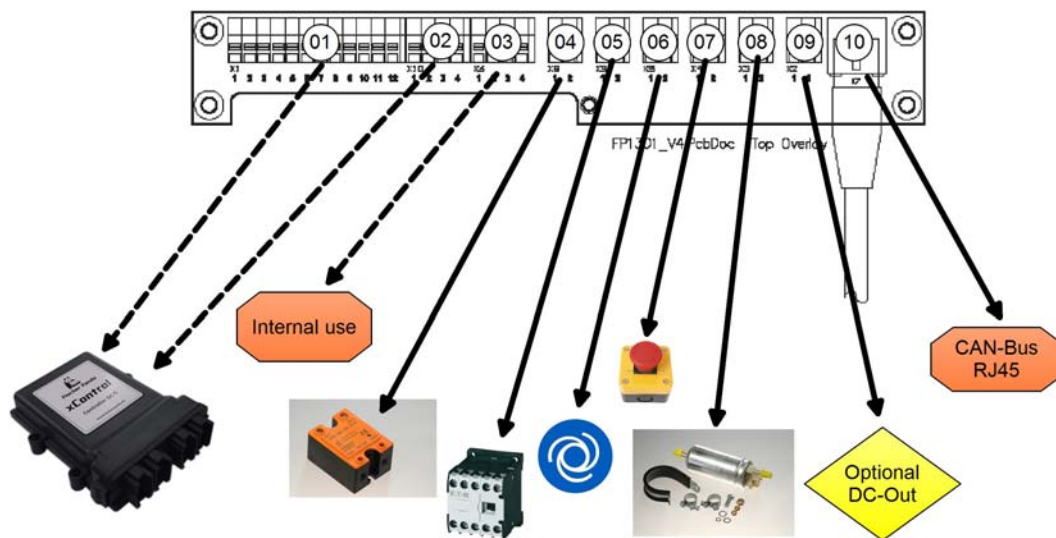


Fig. 5.16.3-1: CP-G



- |     |                             |     |  |
|-----|-----------------------------|-----|--|
| 01. | Terminal xControl ECU       | 06. | Terminal automatic start                           |
| 02. | Terminal xControl ECU       | 07. | Terminal emergency stop                            |
| 03. | FP CAN-Bus for internal use | 08. | Terminal Fuel pump                                 |
| 04. | Terminal boost relay        | 09. | Terminal optional DC-Out                           |
| 05. | Terminal line relay         | 10. | Terminal FP CAN-Bus (external xControl components) |

#### 5.16.3.1 xControl ECU

The xControl ECU is the main modul of the xControl.

installation and modifikation are only allowed by Fischer Panda or authorized service points.

### 5.16.3.2 FP CAN-Bus for internal use

The FP CAN-Bus terminal is for internal use only.

### 5.16.3.3 Boostrelay (optional)

The Boostrelay connects extra capacitors to the generator for a short time to compensate peak load.

### 5.16.3.4 Line Relay (optional)

The line relay protects the consumers against undervoltage and overvoltage. At standard following parameters are set:

Warning : +/- 6% generator nominal voltage.

Relay off: +/- 10% generator nominal voltage.

### 5.16.3.5 Autostart (optional)

With the autostart the generator can be started by an external signal (f.e. SPS).

### 5.16.3.6 Emergency Stop (optional)

With the emergency stop the generator will be stopped as soon as possible. All DC out will be disconnected (Line relay, fuel pump, optional dc out etc.).

If not used, the connection must be bridged.

### 5.16.3.7 Fuel pump

The fuel pump is controlled by the xControl ECU.

### 5.16.3.8 Optional DC-OUT

The optional DC out is pre configured.

At PMS generators for the external electrical water pump.

At vehicle generator for the fan control.

### 5.16.3.9 FP CAN-Bus RJ45

Connection for the external components of the xControl (Controlpanel, Paralleling Device etc.). At the end a termination resistor must be set in.

## 5.17 Radiator fan control / electronic fan control

---

---

To control the radiator fan, various controls/electronic controls can be chosen from the Fischer Panda delivery program.

**In the following the basic functions of the fan controls are described. The original manual/ data sheet with further informations of the fan control must be respected.**

**Note!:**





## 5.18 Standard fan control for 1-phase and 3-phase generators.

In the standard kit, the generators will be equipped with a one step fan control.

### **Fan control 230 V**

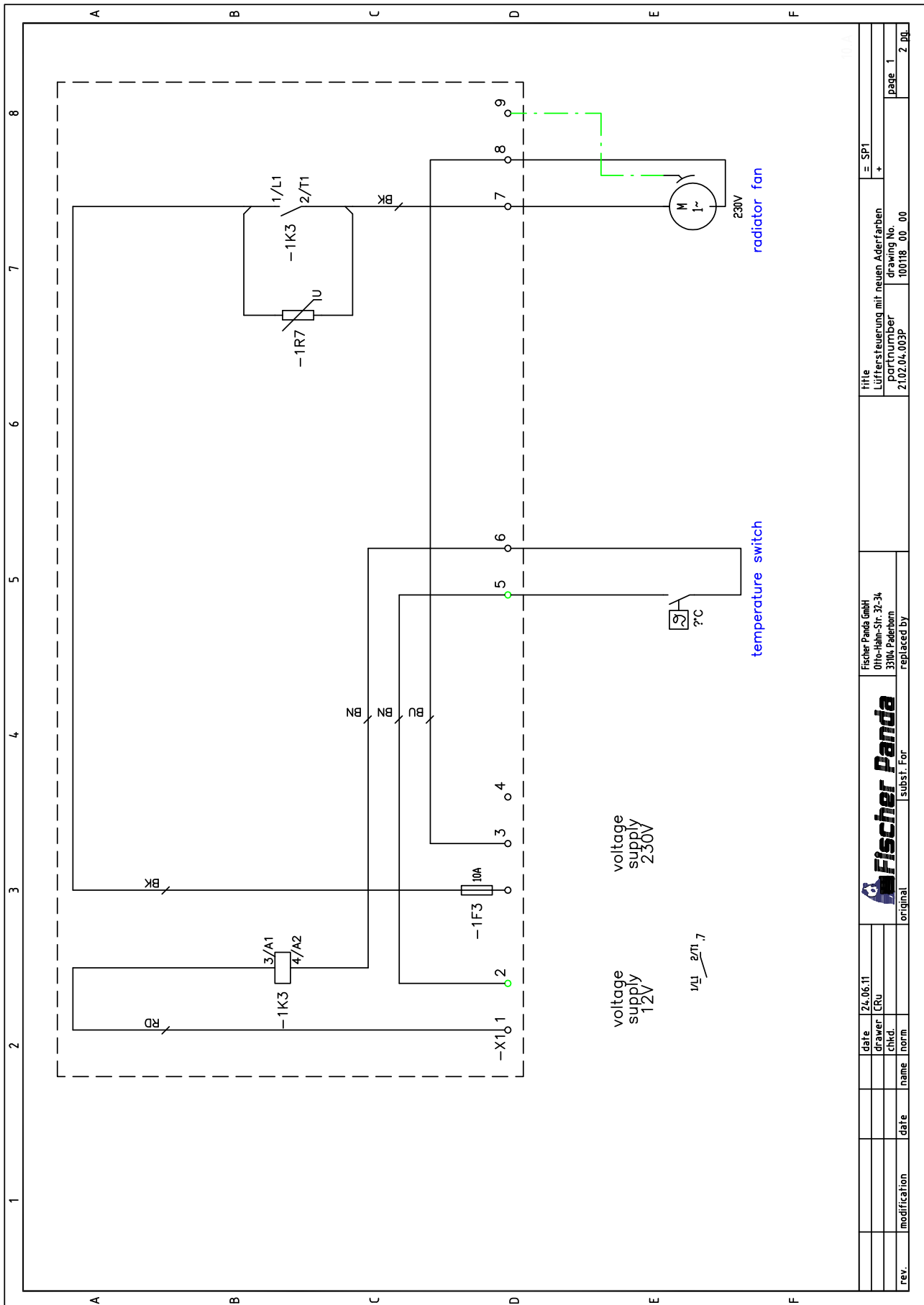
*representative picture*

Fig. 5.18-1: Fan control 230 V





Fig. 5.18-2: Fan control 230 V



rev.	modification	date	name	norm	chkd.	date	24.06.11	24.06.11	original	subst. For	replaced by	3306_Paleborn	01fo-Hahn-Sr. 32-34	Fischer Panda GmbH	21.02.04.003P	partnumber	100118_00_00	drawing No.	100118_00_00	partnumber	21.02.04.003P	title	Lüftersteuerung mit neuen Aderfarben	= SP1	+	page 1	2 pag.
------	--------------	------	------	------	-------	------	----------	----------	----------	------------	-------------	---------------	---------------------	--------------------	---------------	------------	--------------	-------------	--------------	------------	---------------	-------	--------------------------------------	-------	---	--------	--------

## 5.19 Electronic fan control for DC fans RE 0201

For DC Fans the fan control RE 0201 can be used.

Fig. 5.19-1:



## 5.20 Brief description

Temperature-dependent continuous speed controlling device for one or two DC-fans.

### 5.20.1 Function

The speed regulation of the fan is made by pulse tracing modulation (PWM) of the operating voltage. Pulse/no pulse ratio becomes over an external temperature sensor (NTC resistance to attach at clamp 7 and 8) dependent on the coolant temperature. Between the lower limit temperature (starting temperature) and the upper limit temperature the fan is controlled with 30 to 100 % of the available operating voltage (PWM = 30 % to 100 %).

Potentiometer for adjustment concerning temperature and PWM behaviour



<b>Poti Start:</b>	Adjusting the starting temperature (fan start-up). The start temperature is with left stop 60 °C and with right stop 80 °C. Ex factory a starting temperature of 70°C is adjusted (potentiometer position: In the middle).
<b>Poti Window:</b>	Adjusting the temperature window: With the potentiometer „Window“ the size of the window between starting temperature and temperature for full number of revolutions (upper limit temperature) can be adjusted. The temperature window can be adjusted from 5 °C to 20 °C. Is the starting temperature adjusted to 70°C and the temperature window to 10 °C thus the fan start-up with 70°C and reaches the maximum speed with 80°C (upper limit temperature). Ex factory a temperature window of 12,5 °C is adjusted (potentiometer position: In the middle).
<b>Poti Freq:</b>	Adjusting of the PWM frequency. Desired to many customers a potentiometer was added for changing the PWM frequency. A selection of the frequency between approx. 1,7 and 3,5 kHz is possible, which can serve for the avoidance of unwanted oscillation/resonances. Ex factory a PWM frequency of 2 kHz is adjusted.

<b>Function of the temperature sensors (NTC-resistance, extern und intern):</b>	
<b>extern:</b>	Over this temperature sensor the coolant temperature is collected. The starting temperature (fan start-up) and the upper limit temperature can be adjusted by means of potentiometer present at the plate. The PWM ratio starts with the exceeding of the starting temperature with approx. 40% (for 2 seconds), so that the fan starts reliably. According to expiration of the 2 seconds the PWM ratio is determined by coolant temperature and potentiometer adjust. Since the coolant temperature will not continue to rise in the 2 seconds, the PWM ratio will jump back to the minimum value of 30 %. At, from here, far rising coolant temperature, the PWM ratio will then rise linear with the temperature. If the upper limit temperature is nearly reached, the PWM ratio rose to 85 %. By 85% to 100 % PWM ratio with reaching the upper limit temperature switching over is made by one step, in order to avoid very short turn-off times. Likewise switch-back is made with falling coolant temperature of 100 % to 85% PWM ratio. If the coolant temperature falls under the starting temperature, the minimum PWM ratio is not fallen below of 30%, but remains constant. If the coolant temperature sinks approx. 3°C under the starting temperature, then the fan is switched off completely. All data exclusively apply on use of the temperature sensor type S891-100k of the manufacturer Epcos.
<b>intern:</b>	Over this temperature sensor the temperature of the output stage is collected. If the temperature of the output stage rises over 85 °C, the PWM ratio, independently of the coolant temperature, is set to 100 %, in order to avoid the switching losses and cool the output stage down again. If the temperature of the output stage continues to rise nevertheless and beyond 90 °C, the fan controller switches itself off. <b>NOTE: The cooling of the generator is not ensured anymore.</b> If the output stage temperature sinks again under 85 °C, the fan controller restarts itself. Such output stage temperatures cannot occur however with intended use of the equipment.

<b>Light emitting diodes: The 3 light emitting diodes (LED's) indicate the operating condition of the fan controller and have the following meaning:</b>	
<b>LED (green):</b>	Shines with normal operation. After the self check and successful recognizing of the sensors the fan controller jumps into the normal operating condition, in which the fan regulates, if the temperature lies in the appropriate range.
<b>LED (yellow):</b>	Shines if the fan controller is in slave-mode.
<b>LED (red):</b>	Shines with the occurrence of the following errors: Incorrect external temperature sensor. If the temperature sensor for the cooling water is defective or the feeder line to it interrupted (cable break), then the fan is accessed with 100 % PWM. Incorrect internal temperature sensor. If the temperature sensor for the output stage is defective or the feeder line to it interrupted (cable break), then this is indicated over the LED. The fan controller continues working normally. Overheating of the output stage. If the output stage of the fan controller becomes too hot, then this switches itself off. Please read in addition the description of the function of the internal temperature sensor.

### 5.20.2 Master - Slave - Operation

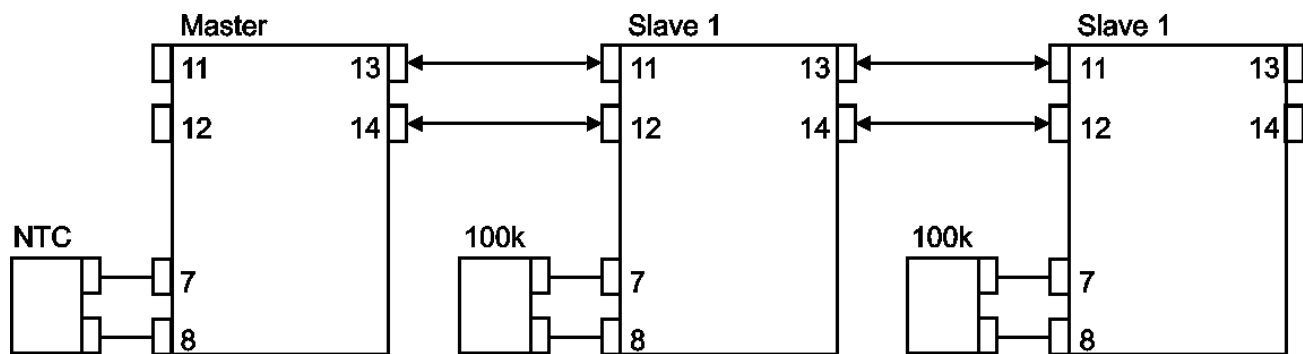
Two or three fan controllers can be connected with each other that over one temperature sensor for the cooling water, all fan controllers can be operated synchronous.

On the connection between master and slave the PWM signal of the masters will transfer. The slave takes over of it the PWM ratio and the frequency. The slave spends its PWM impulse only then if that of the masters is terminated. Thus even load of the current supply is reached. The second slave (if available) regards the first slave as its master (see also drawing).

The slave operation is activated automatically, by the presence of a PWM signal at the slave control inlet. As soon as such a signal is present, the slave follows the control signal and ignores its own adjusts and its own temperature measuring input. If the master does not spend a PWM signal, because the coolant temperature is under its starting temperature, the slave drops back into the master operation and uses its own adjusts and analyses its own temperature measuring input. So that the slave behaves correctly now, a 100k fixed resistor must be attached at its temperature measuring input, which corresponds to a coolant temperature below the starting temperature.

The plug-able plug-in for the master-slave-connection and the 100k fixed resistor belong not to the normal scope of supply and must be ordered separately.

Fig. 5.20.2-1:



### 5.20.3 Function of the clamps for the Master-Slave-Operation

<b>Clamp 11+12:</b>	Control input for slave operation. Clamp 11 is the positive input. Clamp 12 is the negative input. The input is floating, so that via this input connected fan controllers of the same source can be supplied, without a ground loop develops.
<b>Clamp 13+14:</b>	Output for the master-slave-operation. At clamp 13 is the signal and at clamp 14 is ground.

### 5.20.4 Remote controlled switching on and off of the fan controller

The fan controller can be switched on and/or off over the connection „ON“ (clamp 9). If at connection „ON“ lies the same voltage as at the connection „BAT +“, the fan controller is switched on. If at connection „ON“ lies no voltage, the fan controller is switched off. If this option is not needed, then the connection „ON“ can be connected directly on the printed circuit board, over the solder joint J101, with the connection „BAT +“.

- J101 closed: Fan control always on
- J101 open: Fan control only on if operation voltage at connection „ON“

The solder joint J101 is seen from the direct line clamp directly behind the main safety device (main fuse) on the printed circuit board.

### 5.20.5 12 V / 24 V - Operation

For 12 V and/or 24 V-operation the pre-resistor for the operating voltage of control electronics must be adapted. This pre-resistor consists of two resistances, which are connected in series. For 12 V-operation one of these resistances is short circuit with the solder joint J102. For 24 V-operation the solder joint J102 must be opened. Additionally different safety devices (fuses) must be installed depending upon operating voltage.

**Main fuse (flat fuse on the printed circuit board):**

12 V-operation: 50 A flat fuse

24 V-operation: 30 A flat fuse

**Output fuse (plug fuse on the terminal block, each two pieces):**

12 V-operation: 25 A plug fuse

24 V-operation: 20 A plug fuse

## 5.21 Technical Data

<b>Characteristics</b>	
closed current (electronics off)	0,5 mA
closed current (electronics on)	10 - 15 mA
<b>Benchmark figure of the temperature control:</b>	
fan start-up	60 °C - 80 °C
max. number of revolution	65 °C - 100 °C
tolerance of the temperatures	± 5 %
<b>Maximum ratings</b>	
maximum ambient temperature (for operation)	50 °C
<b>Maximum ratings: Battery operation 12 V</b>	
nominal load operating voltage (continuity)	11 VDC - 14.4 VDC
load operating voltage (15min)	- 16.0 VDC
maximum idle speed operating voltage (3 sec)	17 VDC
nominal load current (continuity)	40 A
maximum load current (3 sec)	44 A
nominal voltage fan	12 VDC
<b>Maximum ratings: Battery operation 24 V</b>	
nominal load operating voltage (continuity)	18 VDC - 28.0 VDC
load operating voltage (15min)	- 28.8 VDC
maximum load operating voltage (3 sec)	30 VDC
idle speed voltage (continuity)	34 VDC
maximum idle speed operating voltage (3 sec)	36 A
nominal load current (continuity)	20 A
maximum load current (3 sec)	22 A
nominal voltage fan	24 VDC
<b>Maximum ratings: Transformer operation 12 V</b>	
sieving in the power supply	≥ 10000 µF 63 V (depending on the load current)
<b>data for secondary winding after rectification/sieving</b>	
nominal load operating voltage (continuity)	11 VDC - 14.4 VDC
load operating voltage (15min)	- 16.0 VDC
maximum load operating voltage (3 sec)	17 VDC
idle speed operating voltage (continuity)	28 VDC
maximum idle speed operating voltage (3 sec)	30 VDC
nominal load current (continuity)	40 A
maximum load current (3 sec)	44 A
nominal voltage fan	12 VDC
<b>Maximum ratings: Transformer operation 24 V</b>	
sieving in the power supply	≥ 10000 µF 63 V (depending on the load current)
<b>data for secondary winding after rectification/sieving</b>	
full load operating voltage (15min)	18 VDC - 28.0 VDC
load operating voltage (15min)	- 28.8 VDC
maximum full load operating voltage (3 sec)	30.0 VDC
maximum partial load operating voltage	36.0 VDC
idle speed operating voltage (continuity)	39.0 VDC
maximum idle speed operating voltage (3 sec)	40.0 VDC
maximum input peak voltage	44.0 VDC *1)
maximum output peak voltage	44.0 VDC *1)
nominal load current (continuity)	24 A

maximum load current (3 sec)	28 A
nominal voltage fan	24 VDC

*\*1) The maximum input and/or output peak voltage is measured over the appropriate clamps of the fan controller. It may be exceeded at no time. This applies independently of whether a voltage increased height was possibly caused by the fan controller or an external component. To this belong the switch off-transient of the fan (pulse width modulation = fan will be 2000 times per second switched on and off), and by outside switching operation caused glitches.*

- solder joint J101 closed
- solder joint J102 open
- main fuse 30 A installed
- output fuse 20 A installed

**Attention!: Configuration at delivery for 24 V-operation.**



**For 12 V-operation the installed fuses must be replaced against the provided fuses, as described above. The pre-resistors for the operating voltage of control electronics must be configured like above described.**

**Assembly: Vertical on standard rail, pay attention to good ventilation.**

**At breach of specification can destroy one or more components of the system or shorten the life span substantially.**

**Subject to change without prior notice.**

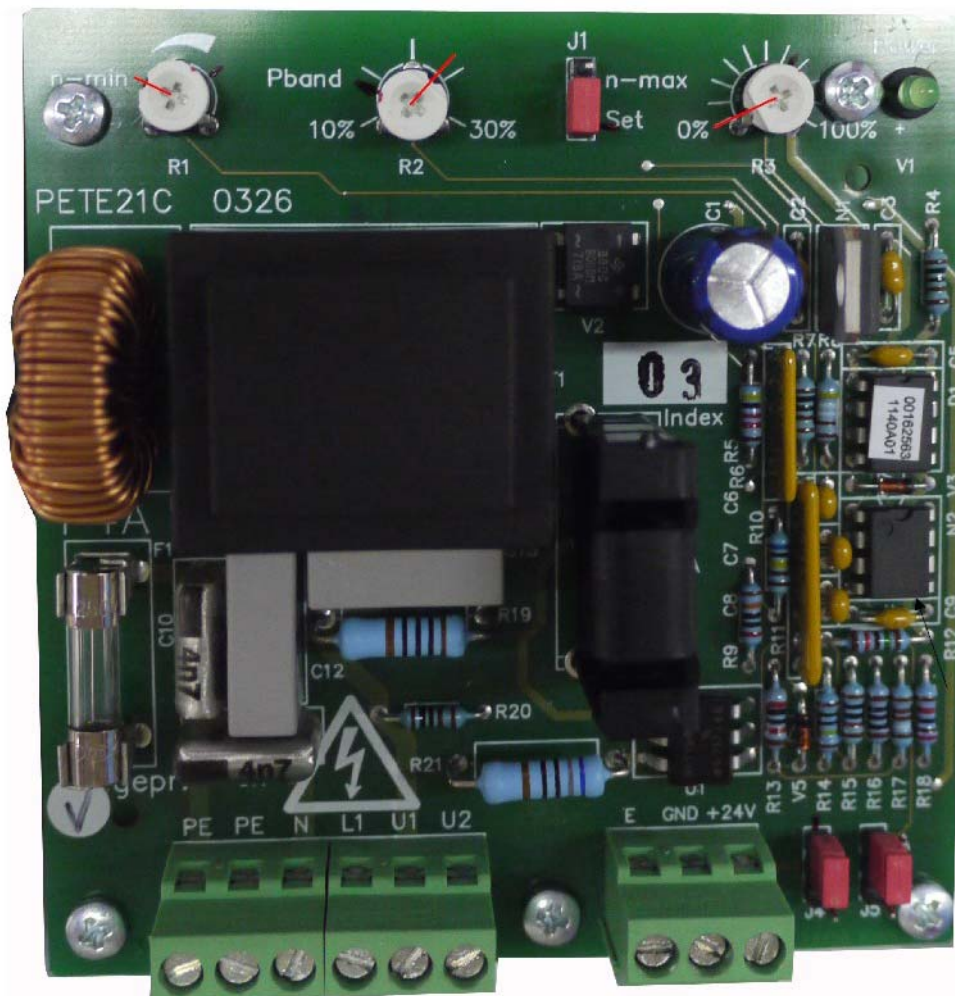
## 5.22 Electronic fan control for single phase fans PKE-2.5V\_Ziehl Abegg

The electronic fan control variety the fan rpm stepless.

### 5.22.1 Preset for the use with Fischer Panda generators

The Ziehl Abegg fan control is preset for the use with Fischer Panda generators. For the preset following data and jumper settings are used.

Fig. 5.22-1: Preset

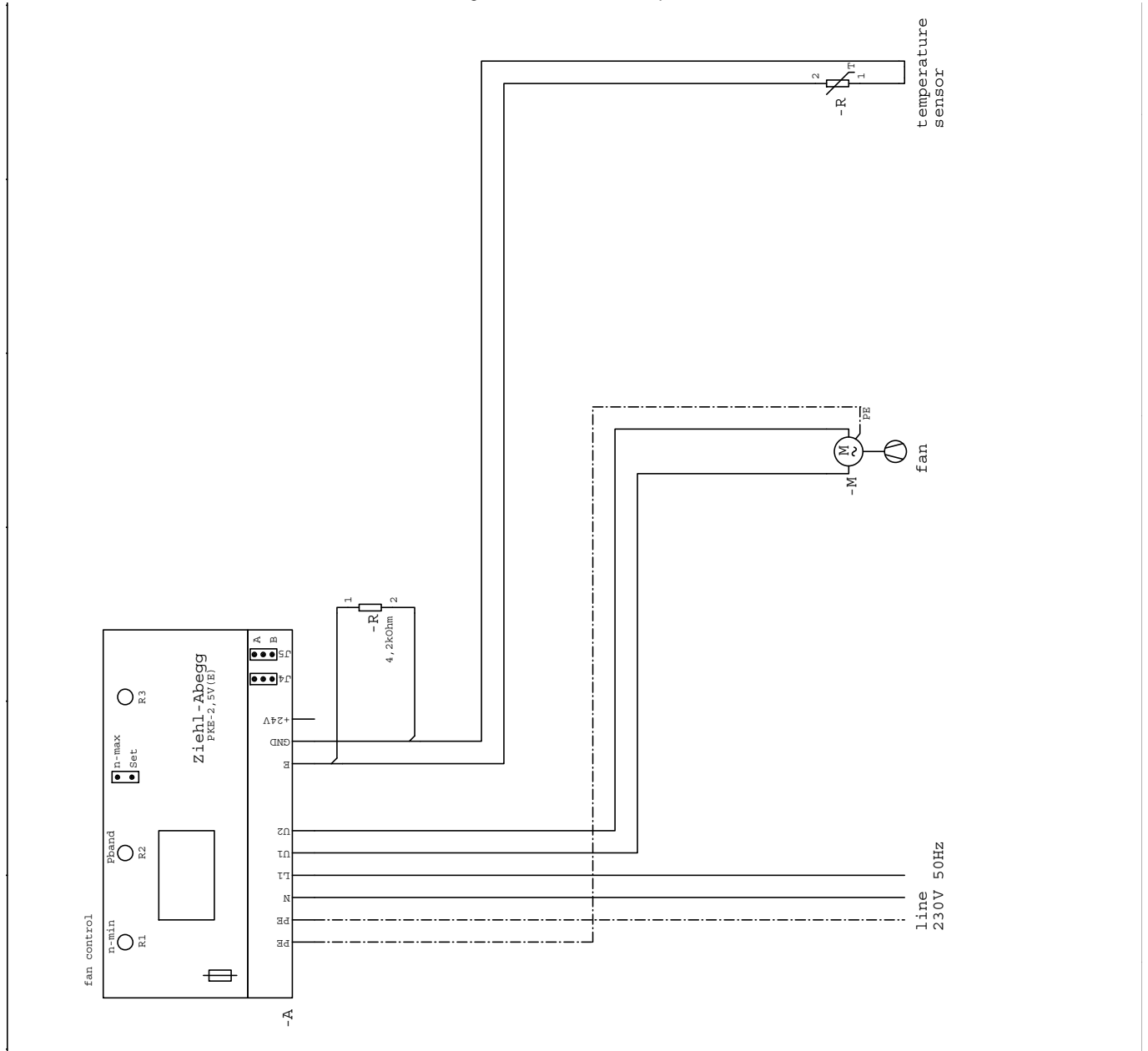




### 5.22.2 Connection of the sensor (Ziehl Abegg KTY)

The sensor is connected to E/GND. A resistor 4,2kOhm must be connected parallel to the sensor.

Fig. 5.22.2-1: Connection plan



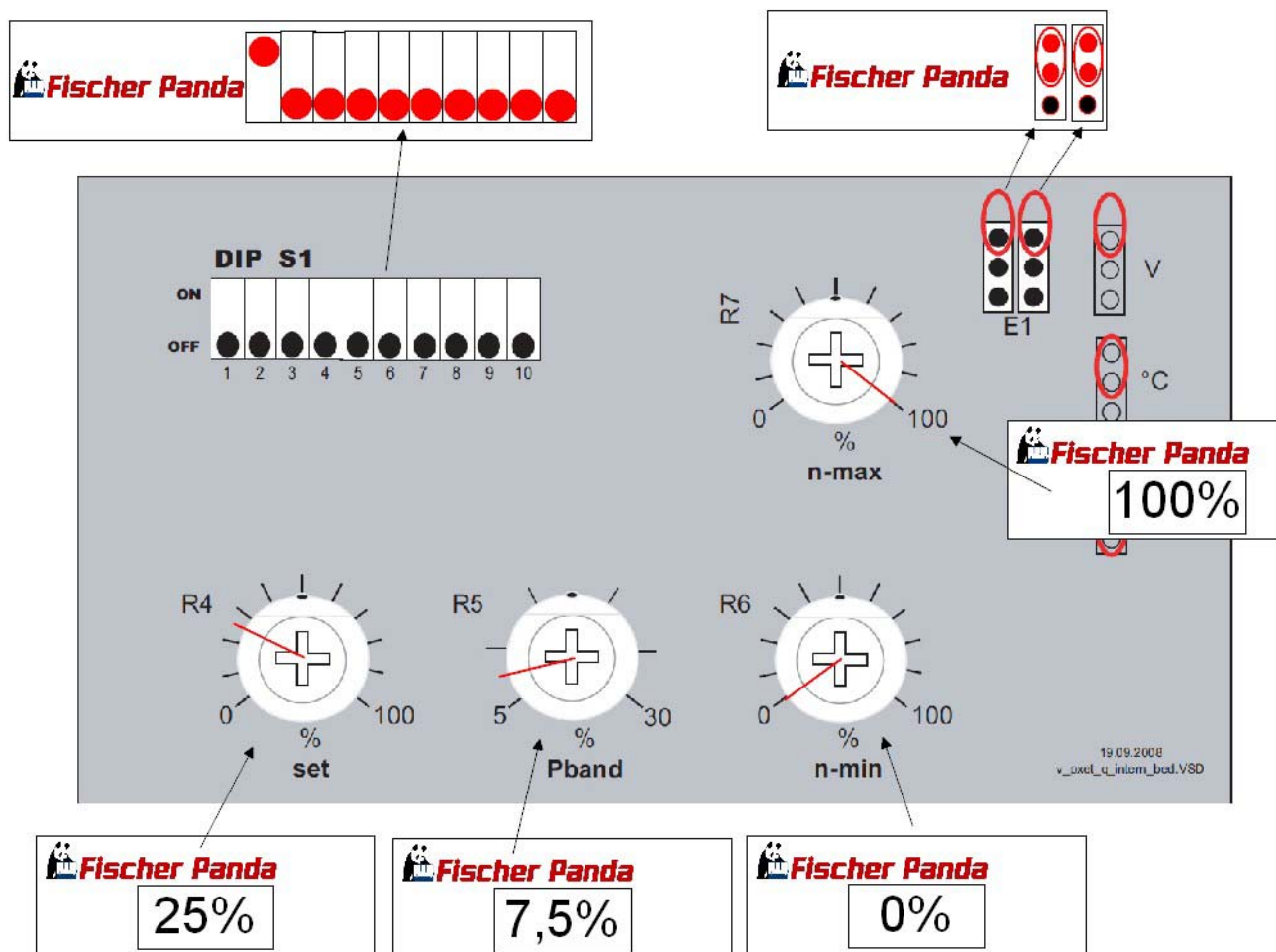
## 5.23 Electronic fan control for single phase fans PXET6Q\_Ziehl Abegg

The electronic fan control variety the fan rpm stepless.

### 5.23.1 Preset for the use with Fischer Panda generators

The Ziehl Abegg fan control is preset for the use with Fischer Panda generators. For the preset following data and jumper settings are used.

Fig. 5.23-1: Preset

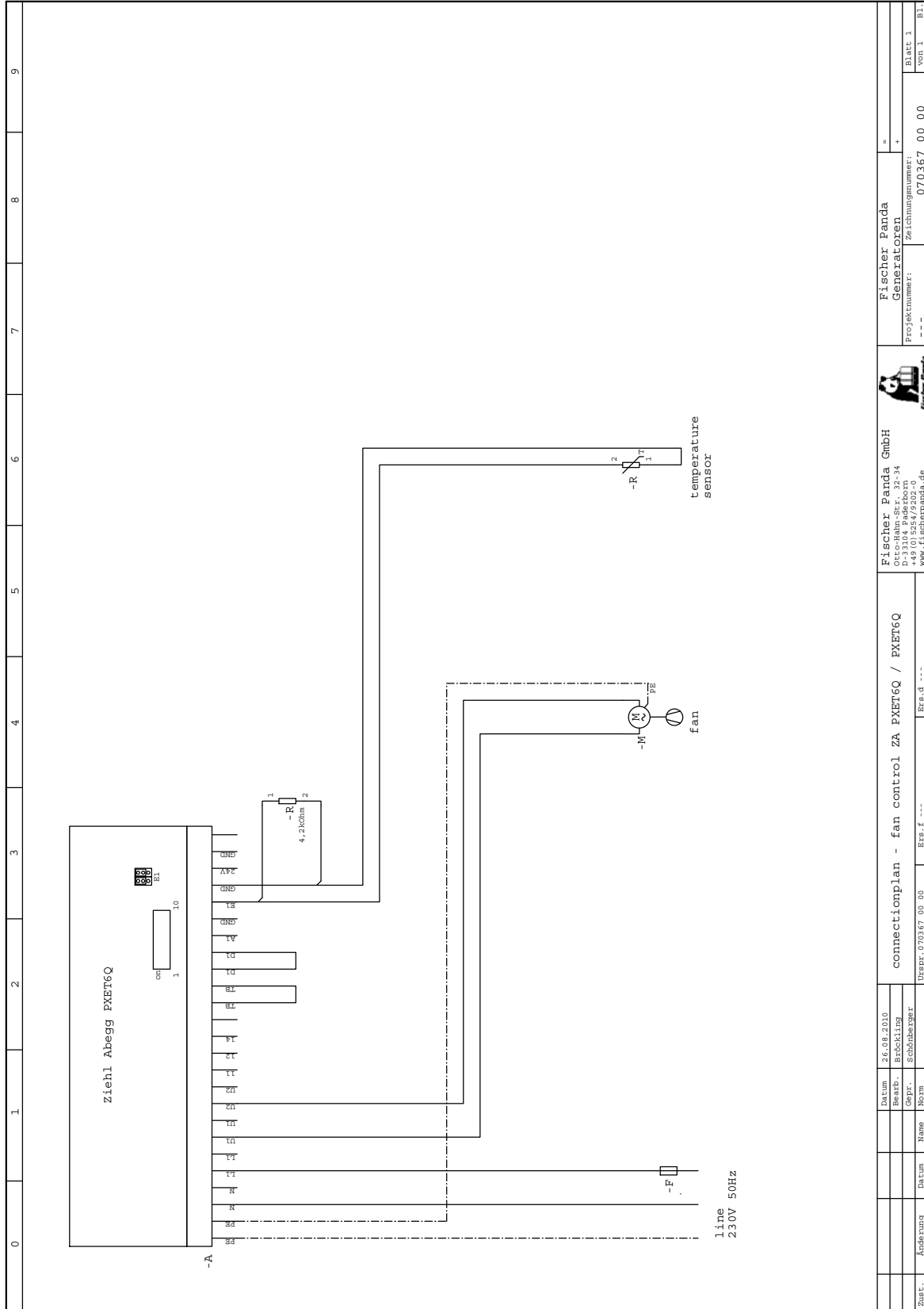


### 5.23.2 Connection of the sensor (Ziehl Abegg KTY)

The input TB and D1 are bridged.

The sensor is connected to E1/GND. A resistor 4,2kOhm must be connected parallel to the sensor.

Fig. 5.23.2-1: Connection plan



Zust.	Änderung	Datum	Name	Norm	Urspr. 070367 00 00	Err. f. ---	Err. d. ---	Erz. f. ---	Erz. d. ---	connectionplan - fan control ZA PXET6Q / PXET6Q	Fischer Panda GmbH Otto-Hahn-Str. 32-34 D-33104 Paderborn www.fischerpanda.de	Fischer Panda Generatoren	Projektnummer: -- --	Zaichnungsnummer: 070367 00 00	= +	Blatt 1 von 1	B.I.
-------	----------	-------	------	------	---------------------	-------------	-------------	-------------	-------------	---	--	------------------------------	-------------------------	-----------------------------------	--------	------------------	------

## 5.24 Electronic fan control for 3 phase fans PKD T5/PKD M10 Ziehl Abegg

The electronic fan control varies the fan rpm stepless.

### Fan control PKD T5

*representative picture*

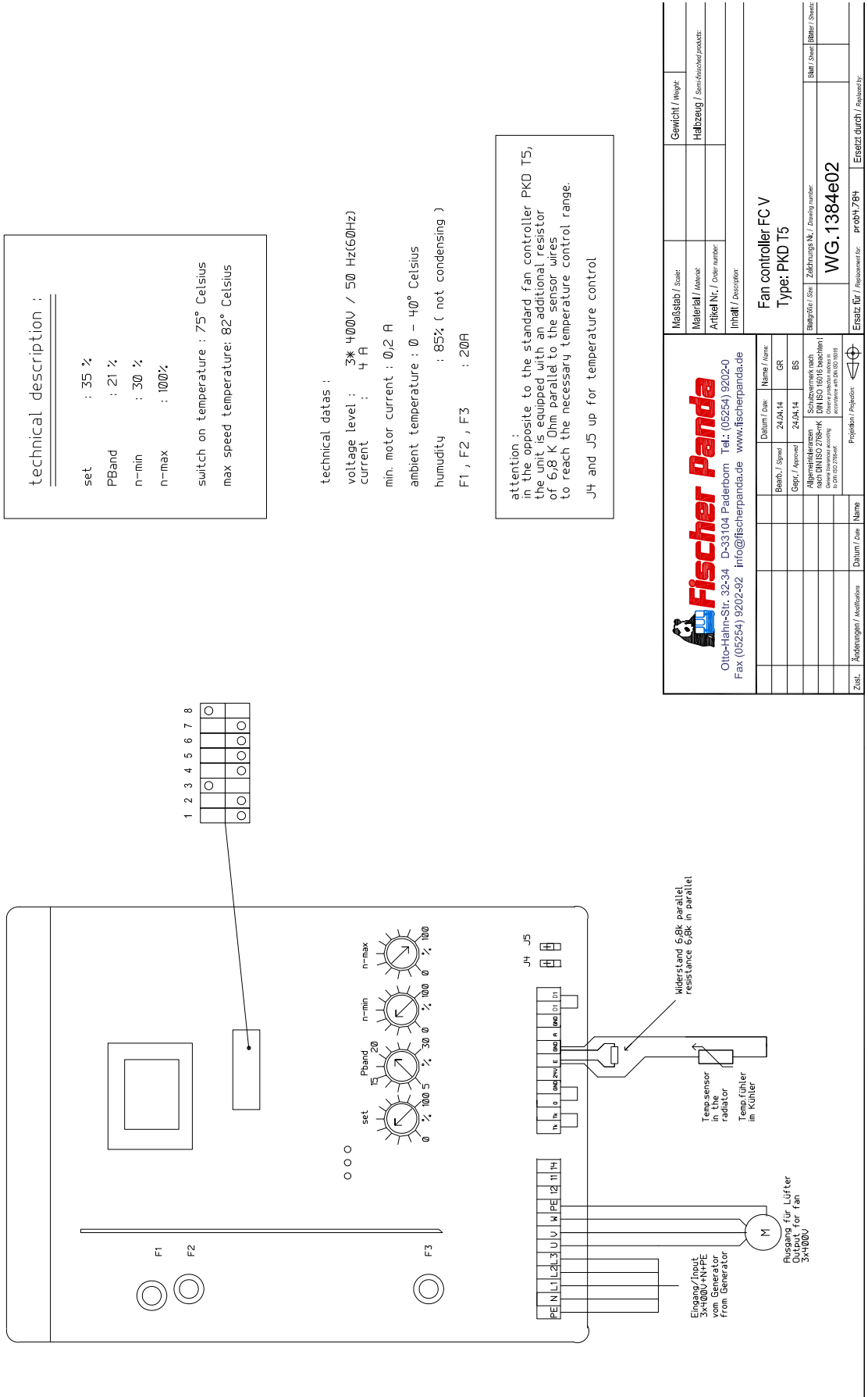
Fig. 5.24.0-1: Fan control PKD T5



Leere Seite / Intentionally blank

### 5.24.1 Configuration of the electronic fan control PKD T5 for Fischer Panda Generators

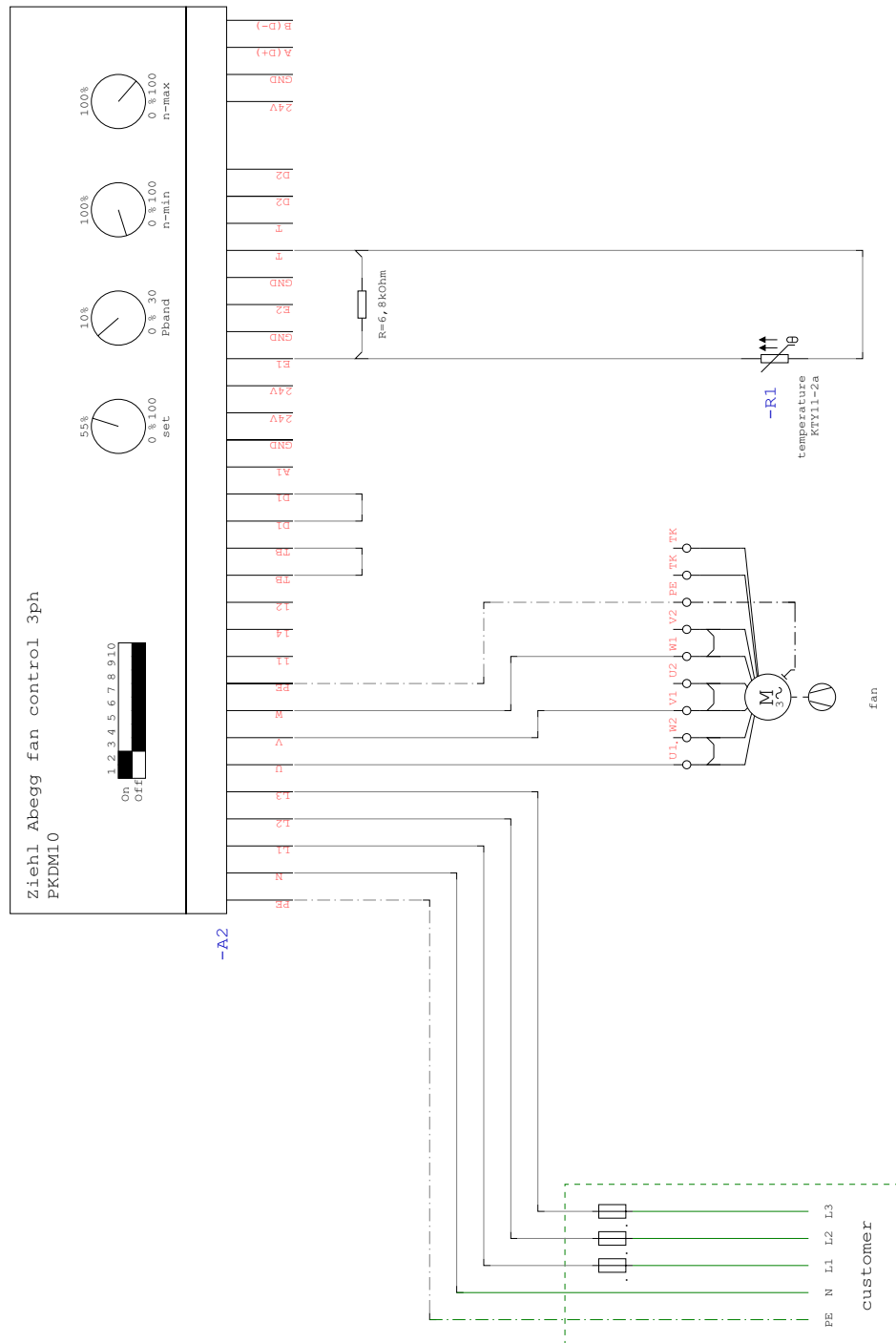
Fig. 5.24.1-1: Configuration of the fan control PKD T5 for Fischer Panda Generators



<p>Olto-Hahn-Str. 32-34 D-33104 Paderborn          Fax (05254) 9202-922 Info@fischerpanda.de www.fischerpanda.de</p>		<p>Beinh. / Signs: 24.04.14 GR</p> <p>Gepr. / Approved: 24.04.14 BS</p> <p>Alle Angaben sind nach DIN ISO 9001:2008 (DIN EN ISO 9001:2008) zu verstehen. Die Angaben sind ohne Gewähr. (All data are subject to change without notice. The data are without warranty.)</p> <p>Projektdr. / Projector: </p>
<p>Material / Serie:   Gewicht / Weight:</p>	<p>Material / Material:   Halbzug / Semi-finished product:</p>	<p>Artikel Nr. / Order number:   Inhalt / Description:</p>
<p>Fan controller FC V          Type: PKD T5</p>		<p>Blatt / Sheet: Blatt / Sheet</p>
<p>Ersatz für / Replacement for: probH.78H</p>		<p>WG. 1384e02</p>
<p>Material / Serie:   Gewicht / Weight:</p>	<p>Material / Material:   Halbzug / Semi-finished product:</p>	<p>Artikel Nr. / Order number:   Inhalt / Description:</p>
<p>Fan controller FC V          Type: PKD T5</p>		<p>Blatt / Sheet: Blatt / Sheet</p>
<p>Ersatz für / Replacement for: probH.78H</p>		<p>WG. 1384e02</p>

## 5.25 Configuration of the electronic fan control PKD M10 for Fischer Panda Generators

Fig. 5.25.0-1: Configuration of the fan control PKD M10 for Fischer Panda Generators



## 5.26 Insulation test

---

---

Once the electrical system installation is complete, a ground insulation test must be performed as follows:

**ATTENTION!**



- 1.) Switch off all on-board electrical devices.
- 2.) Start the generator.
- 3.) Measure the AC-voltage with a voltmeter (adjust to Volt/AC) between:
  - a) generator housing and AC-Control box
  - b) generator housing and ground.

The measured voltage must not exceed 50mV (millivolts).

4.) Once the safety systems have been installed, they must be checked. If a Leakage Current Relay has been installed, it also has to be tested, in order to ensure that it functions properly. The individual phrases must be checked against each other, and between phase and ground, (the single phase or 4th phase also needs to be checked in this fashion).

5.) If the generator is protected by a ground connection, then ALL electrical devices must also be connected to this "common" ground (usually ground contacts are attached to the devices' metallic housings).

The electrical system installation must also comply with the hook-up requirements of the shore current grid. Generally a leakage current relay is sufficient for safe electrical operation; however, this must be confirmed by the electrical safety standard in the region where the system is attached to a main land power grid. The relay has to meet the required safety standard regulations.

## 5.27 Set into operation

---

---

After the installation the generator must be brought in service. For this the „Service record and warranty registration must be worked through and filled out by the installing technical trained person.

This document must be handed out to the owner. The owner must be instructed for the operation, maintenance and hazards of the generator. These include the in the manual mentioned hazards and further ones, which are the result of the specific installation and the connected components.

**Send the original Service and warranty record to Fischer Panda to get full warranty. Make a copy for your hands. Note!:**







## 6. Generator operation instruction

### 6.1 Personal requirements

---

Only instructed persons are allowed to run the generator. Instructed Persons has read the manual of the generator and all ancillary components and external equipment. He must be acquaint with the specific risks and safety instructions.

Only persons who are expected to perform their tasks reliably are permitted as personnel. Persons whose reaction capability is impaired, e.g. through drugs, alcohol or medication are not permitted.

When selecting the personnel, the stipulations regarding age and occupation applying at the location must be observed.

### 6.2 Hazard notes for the operation

---

**Please note the safety first instructions in front of this manual.**

**Notice!:**



**Danger for life! - The generator can be equipped with a automatic start device. This means the generator can be started by an external signal.**

**Warning!: Automatic start**



To avoid an unexpected starting of the generator, the starter battery must be disconnected before start working at the generator.

**Rotating parts inside of the generator**

**Attention!: Danger to life**



Do not run the generator with removed sound cover. If it is necessary to test the generator without sound cover, pay special attention. Never do this work alone. Do all service, maintenance and repair with engine stopped.

**Danger for Life. Improper handling, operation, installation and maintenance can result in severe personal injury and/or material damage.**

**Attention!: Danger to Life - High voltage**



Electrical voltages above 48 volts (battery chargers greater than 36 volts) are always dangerous to life). The rules of the respective regional authority must be adhered to. Only an electrician may carry out installation of the electrical connections for safety reasons.

### 6.3 General operating instruction

---

#### 6.3.1 Operation at low temperatures

---

The Generator can be started at temperatures down to - 20 °C, therefor the operation fluids like fuel, cooling water, lubricant oil ect. must be suitable for this temperatures. These should be checked before start. Cold start spray ect. are not allowed to use, or the warranty will be lost.

### 6.3.1.1 Pre-heating the diesel motor

Pre-chamber diesel engines are equipped with a quick glow plug. The maximum pre glow time should not exceed 20 sec. At 20 °C or more the pre glow time should be about 5-6 sec. Below 20 °C the pre glow time should be increased,

**If the operation fluids have been drained and then filled with cold weather fluids, always run the generator for 10 minutes to ensure the new fuel is present throughout the system.**      **Note:**



### 6.3.1.2 Tips regarding starter battery

Fischer Panda recommends normal starter battery use. If a genset is required for extreme winter conditions, then the starter battery capacity should be doubled. It is recommended that the starter battery be regularly charged by a suitable battery-charging device (i.e., at least every 2 Months). A correctly charged starter battery is necessary for low temperatures.

## 6.3.2 Light load operation and engine idle

---

If an engine is operated on a load less than 25-30 % of its rated output, the soot of the generator will be observed which may give cause for concern. The usual results of this operation are heavier than normal lubricating oil consumption, and oil leaks from the air and exhaust manifolds. This condition is particularly evident on standby generator set applications.

### 6.3.2.1 The soot of the generator is due to the fact that:

The cylinder temperatures are too low to ensure complete burning of all the fuel delivered.

A further result is that of abnormal carbon build-up on the valves, piston crowns and exhaust ports. Fuel dilution of the lubricating oil will also occur.

### 6.3.2.2 To prevent the soot of the generator following steps should be observed:

Running on light load should be avoided or reduced to the minimum period.

In a period of 50 operation hours the engine or generator set should be run on full load for four hours, to burn off accumulations of carbon in the engine and exhaust system. This may require the use of a 'dummy load'. The load should be built up gradually from 30 % to 100 % within 3 hours and hold at 100 % for one hour.

## 6.3.3 Generator load for a longer period and overload

---

Ensure the generator is not overloaded. Overloading occurs when the electrical load is higher than the generator can provide. If this occur for a longer period, the engine may be damaged. Overloading may cause rough running, high oil and fuel consumption, increased emissions.

For a long engine life, the long term load should not exceed 80 % of the nominal load. Long term load is the load over several hours. It is harmless for the generator to deliver full nominal power for 2-3 hours.

The whole conception of the Fischer Panda generator make sure, that the full power operation at extreme condition will not increase the engine temperatures over. Please note that the emissions of the generator also increase at full power operation.

### 6.3.4 Protection conductor:

---

The standard Panda generator is grounded. The 3-phase connection (delta) centre point is bridged to earth in the AC output terminal box (mounted on the generator). This is the initial earth safety point and is sufficient to ensure safe operation however only as long as no other system is installed. This system is adapted to enable test running of the generator before delivery.

The bridge to ground (PEN) is only effective when all components in the electrical system share a common ground. The bridge to ground can be removed and reconnected to another ground system if required for other safety standards.

Full voltage connections are mounted in the electrical cabinet. It must be ensured that the electrical cabinet is secured and closed while the generator is running.

The starter battery cable should be disconnected when work is being done on either the generator or the electrical system in order to prevent accidental starting of the generator.

### 6.3.5 Operating control system on the Fischer Panda generator

---

Fischer Panda generators are equipped with various sensors/temperatures switches. The combustion engine is further equipped with a oil pressure control switch, which switches the motor off, if the oil pressure sinks to a particular level.

## 6.4 Instructions for capacitors - not present at all models

---

#### Danger to Life - High voltage

#### CAUTION!

Do not touch the capacitor contact terminals!



The generator's electrical system requires two different groups of capacitors:

- A) The booster capacitors
- B) The operating capacitors

Both types are mounted in the electrical cabinet. (At some models direct on the generator)

Capacitors store an electrical charge. It is possible that even after they have been disconnected stored energy is still held. Therefore it is essential that the connectors are not touched.

Should it be necessary to check or test the capacitors, they should be shorted out by using an insulated screw driver.

The operating capacitors are automatically discharged when the generator is stopped in the normal way. The booster capacitors will be discharged through internal resistors.

For safety however, the capacitors have to be discharged (short circuited) prior to carrying out any work on the AC-Control box.

## 6.5 Checks before start, starting and stopping the generator

---

see remote control panel data sheet/manual

**The instructions and regulations of the remote control panel data sheet/manual must be respected.** **Note:**

*Respect the safety instruction in front of this manual.*



## 6.6 Instructions for capacitors - not present at all models

---

### Danger to Life - High voltage

### CAUTION!

Do not touch the capacitor contact terminals!



The generator's electrical system requires two different groups of capacitors:

- A) The booster capacitors
- B) The operating capacitors

Both types are mounted in the electrical cabinet. (At some models direct on the generator)

Capacitors store an electrical charge. It is possible that even after they have been disconnected stored energy is still held. Therefore it is essential that the connectors are not touched.

Should it be necessary to check or test the capacitors, they should be shorted out by using an insulated screw driver.

The operating capacitors are automatically discharged when the generator is stopped in the normal way. The booster capacitors will be discharged through internal resistors.

For safety however, the capacitors have to be discharged (short circuited) prior to carrying out any work on the AC-Control box.

## 7. Maintenance Instructions

### 7.1 Personal requirements

---

All maintenance, if not special marked, can be done by the trained persons.

Further maintenance must be done by technical personal or Fischer Panda service points.

### 7.2 Hazard notes for the maintenance and failure

---

**Follow the general safety instruction at the front of this manual.**

**Notice!**



**Danger for life! - The generator can be equipped with a automatic start device. This means the generator can be started by an external signal. To avoid an unexpected starting of the generator, the starter battery must be disconnected before start working at the generator.**

**Warning!: Automatic start**



**Working at a running generator can result in severe personal injury. Therefore before starting work at the generator:**

**Warning!: Risk of injury**



Make sure that the generator is stopped and the starter battery is disconnected to guarantee that the generator cannot be inadvertently started.

Do not run the generator with removed sound isolation cover

**Improper installation/maintenance can result in severe personal injuries or material damage.**

**Warning!: Risk of injury**



- Always undertake installation/maintenance work when the generator is switched off.
- Ensure there is sufficient installation clearance before start working.
- Ensure tidiness and cleanliness at the workplace. Loose components and tools lying around or on top of each other are sources of accidents.
- Only perform installation work using commercially available tools and special tools. incorrect or damaged tools can result injuries.

**Oil and fuel vapours can ignite on contact with ignition sources. Therefore:**

**Warning!: Danger of fire**



- No open flames during work on the generator.
- Do not smoke.
- Remove oil and fuel residues from the generator and floor.

**Contact with engine oil, antifreeze and fuel can result in damage to health. Therefore:**

- Avoid skin contact with engine oil, fuel and antifreeze.
- Remove oil and fuel splashes and antifreeze from the skin immediately.
- Do not inhale oil and fuel vapours.

**Danger for Life. Improper handling, operation, installation and maintenance can result in severe personal injury and/or material damage.**

Electrical voltages above 60 volts are always dangerous to life). The rules of the respective regional authority must be adhered to. Only an electrician may carry out installation of the electrical connections for safety reasons.

**Generator, oil and antifreeze can be hot during/after operation. Risk of severe burns.**

**During Installation/maintenance personal protective equipment is required to minimize the health hazards.**

- Protective clothing
- safety boots
- protective gloves
- Ear defender
- safety glasses

**Disconnect all load during the work at the generator to avoid damages at the load.**

**Batteries contains acid or alkalis.**

Improper handling can result in battery explosion and leakage. Acid or alkalis can run out. An explosion of the battery is possible.

*See the operation and safety instruction from your battery manufacturer.*

Batteries contain corrosive acids and lyes.

Improper handling can cause the batteries to heat up and burst. Corrosive acid/lye may leak. Under unfavorable conditions, the battery may explode.

Observe the instructions from your battery manufacturer.

**Danger!: Danger of poisoning**



**ATTENTION!: Danger to Life - High voltage**



**Warning!: Hot surface/material**



**Instruction!: Personal protective equipment necessary.**



**Attention!: disconnect all load**



**Warning!:**



## 7.3 Environmental protection

---

### Danger to the environment due to mishandling!

Significant environmental damage can occur, particularly for incorrect disposal, if environmentally hazardous operating materials are mishandled. Therefore:

- Always observe the instructions mentioned below.
- Take immediate action if environmentally hazardous materials reach the environment. Inform the responsible local authorities about the damage in the case of doubt.

*The disposal must be performed by a specialist disposal company.*

### Environmental protection.



## 7.4 Maintenance Requirements

---

### Control before starting

- Oil level
- Cooling system leaks
- Visual check for any changes, leaks oil drain system, v-belt, cable connections, hose clips, air filter, fuel lines

### Once a week

- Lubrication of actuator-trapezoid thread spindle

## 7.5 Maintenance interval

---

For the maintenance intervals, see the „General information for vehicles generators“ which are attached to this manual.

For generators with dynamic maintenance interval (for example generators with iControl2). Further informations are in the remote control panel manual/data sheet.

**With the dynamic operation hours the service interval can be raised up to 30% (200h max.). Make sure that the dynamic operation hours are not reset accidentally between the service interval.**

### Note:



## 7.6 De-aerating of the coolant circuit

---

### Particular hints for the de-aerating of the cooling system

If the coolant has been drained or if air has permeated into the cooling system by other reasons, a careful ventilation of the cooling system is necessary. The de-aerating process has to be rerun several times.

**Open de-aerating screw at the cooling water pump.**

representative picture

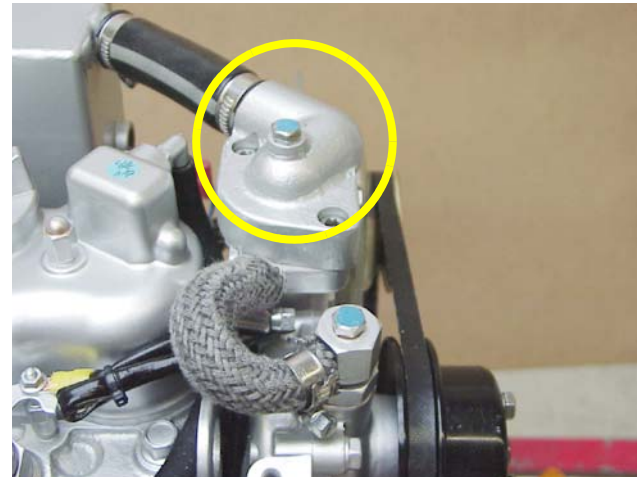
*Fig. 7.6-1: De-aerating screw*



**Open de-aerating screw at the thermostat-housing**

representative picture

*Fig. 7.6-2: De-aerating screw*



**Open de-aerating screw at the water-cooled silencer.**

representative picture

*Fig. 7.6-3: De-aerating screw*





**Pour in coolant through the cooling water filler cap. The coolant flows in very slow.**

representative picture

*Fig. 7.6-4: Cooling water filler cap*



If it is to be recognized that the cooling water level does not sag any longer (with cold cooling water the cooling water level must cover the sheet metal in the exhaust elbow union), close the de-aerating screws and start the generator. Run the generator to maximally 60. Switch off generator.

**Open the cooling water filler neck again and also the de-aerating screws at the same time.**

**Fill in again cooling water.**

representative picture

*Fig. 7.6-5: Cooling water filler cap*



Repeat this procedure several times.

The generator can be started for 5 minutes, if there is no change. De-aerating must be then repeated two or three times.

To be sure that the coolant circulates it is very important that the hose pipe away from the genset also gets warm. After a short time the radiator and the reverse-flow pipe from the radiator to the genset also get warm.

Please wait until the temperatures raise more and check if the fan will activate.

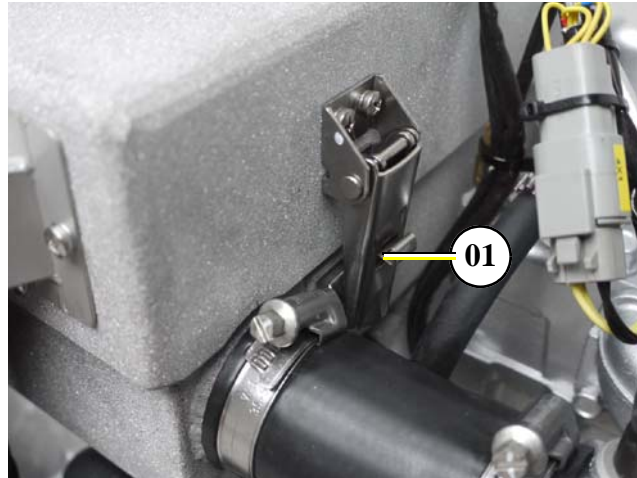
It makes sense to, once again, repeat the de-aerating procedure after a few days, in order to ensure that remaining air bubbles have been finally removed.

## 7.7 Replacing the air filter

1. Open the closure on the right-hand side of the air intake housing

01. Closure

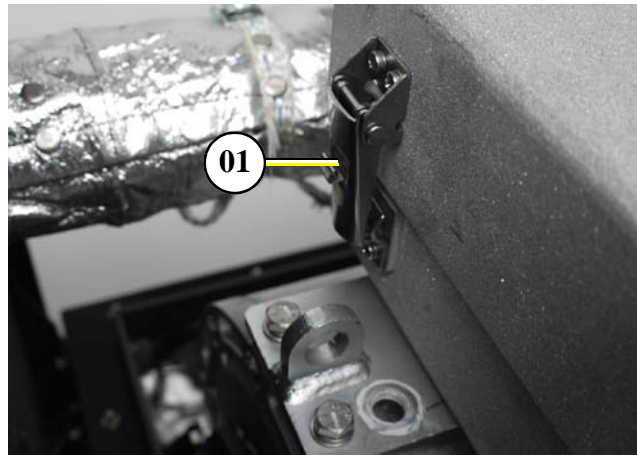
*Fig. 7.7-1: Replace air filter*



2. Open the closure on the left-hand side of the air intake housing.

01. Closure

*Fig. 7.7-2: Replace air filter*

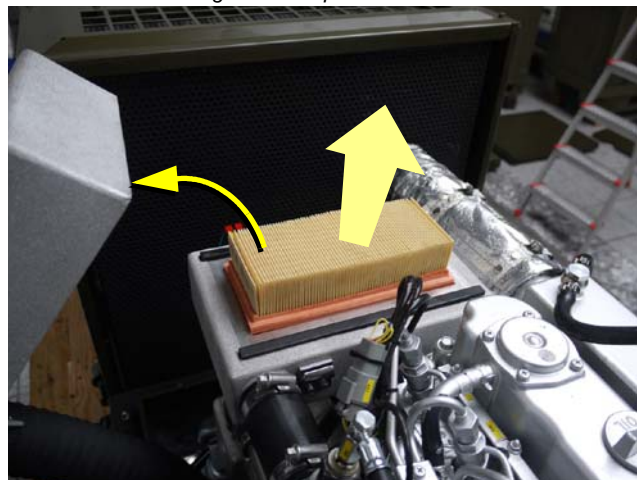


3. Lift up the housing cover and pull it backwards.

4. Replace the air filter.

5. To reinstall, reverse the order of steps.

*Fig. 7.7-3: Replace air filter*



## 7.8 Checking oil-level

You require:

paper towels / cloth for the oil dipstick

The generator must be placed at level.

- with vehicular generators: Place the vehicle on a levelled surface.
- with PSC generators: Place the generator on a levelled surface.
- with marine generators: Measure the oil-level when the ship is not lop-sided.

Run the generator for about 10 minutes to ensure that the engine is warm. Wait for 3 minutes, so the oil can flow back into the oil pan.

**Generator and coolant can be hot during and after operating.**

**Caution: Burn hazard!**



Wear personal protective equipment. (Gloves, protective goggles, protective clothing and safety shoes)

- Assure generator against accidental start.
- Open the generator casing.
- Pull the oil dipstick out of the check rail.
- Clean oil dipstick.
- Put the oil dipstick back into the check rail and wait for 10 seconds.
- Pull the oil dipstick out of the check rail and read off the oil-level at the lower end of the stick.

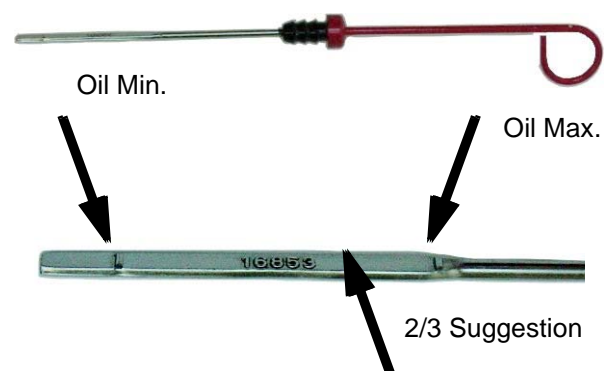
### Oil dipstick

The oil-level is to be checked by means of the oil dipstick. The prescribed filling level must not cross the „Max“-mark.

*We recommend an oil-level of 2/3.*

*Sample picture*

Fig. 7.8-1: Oil dipstick - Sample



## Oil dipstick EA 300 Engine

The oil-level is to be checked by means of the oil dipstick. The prescribed filling level must not cross the „Max“-mark.

*We recommend an oil-level of 2/3.*

*Sample picture*

Fig. 7.8-2: Oil dipstick



Oil should be refilled, if the oil-level is under 1/3 between the minimum and the maximum mark.

Fischer Panda recommends an oil-level of 2/3 between the minimum and the maximum mark.

If the oil-level is under the MIN-mark, check how many operating hours went by since the last oil change, by means of your service manual or an existing oil change tag. - with operating hours between 50 and 150 hours it is only necessary to refill oil. See „Refilling oil“ on page 2.

- with 150 operating hours or more the oil should be changed (See your generators' service table)
- if the oil-level is under the minimum mark by less than 50h, there might be a technical problem! In that case, we recommend going to a shop or a Fischer Panda service point.
- if the oil is cloudy or even „creamy“, coolant might have mixed with the oil. See a garage or a Fischer Panda service point immediately.

### 7.8.1 Refilling oil

---

#### You require:

#### Engine oil

1. Check oil-level as described under section 7.8, “Checking oil-level,” on page 107.
2. Oil dipstick is pulled out of the check rail.
3. Open the oil filler cap.
4. Fill in oil (approx. 1/2 litre) and wait for about 2 min. so this it can flow into the oil pan.
5. Wipe off the oil dipstick and put it into the check rail.
6. Pull the oil dipstick out of the check rail and check the oil-level. See section 7.8, “Checking oil-level,” on page 107.

If oil-level is still too low (under 2/3): repeat steps 4-6.

### 7.8.2 After the oil level check and refilling the oil

---

- Put the oil dipstick back into the check rail.
- Close the oil filling cap.
- Remove potential oil stains and splashes from the generator and surroundings.
- Close the generator casing.
- Remove lock against accidental generator start.

## 7.9 Replacement of engine oil and engine oil filter

---

You require:

- Engine oil. See attachment.
- New oil filter (not with generators with EA300 engines)
- Sealing for oil drain screw
- Personal protective gear
- Container to collect used oil (heat resistant and of sufficient size)
- Open-ended wrench for oil drain screw
- Paper towels and cloth
- Oil filter wrench
- Oil resistant mat, so prevent used oil from getting into underground water

The generator must be placed at level.

- with vehicular generators: Place the vehicle on a levelled surface.
- with PSC generators: Place the generator on a levelled surface.
- with marine generators: Change the oil when the ship is not lop-sided.

Run the generator for about 10 minutes to ensure that the engine is warm.

Wait for 3 minutes, so the oil can flow back into the oil pan.

**Generator and coolant can be hot during and after operating.**

**Caution: Burn hazard!**



Wear personal protective equipment. (Gloves, protective goggles, protective clothing and safety shoes)

### 1. Prepare generator.

- Assure generator against accidental start.
- Open the generator casing.
- with generators that have an external oil drain hose: Release the oil drain hose from the mounting.
- with generators that have an internal oil drain hose: Open the lead-through for the oil drain hose (left turn of the sealing). Pull out the sealing with the oil drain hose.

Place an oil resistant mat under the oil drain hose area and prepare the container.



### 2. Loosen oil filling cap

Unscrew the oil filling cap. This is necessary, because otherwise a vacuum will form and the oil can not completely drain off.

Sample picture

Fig. 7.9-1: Oil filling cap



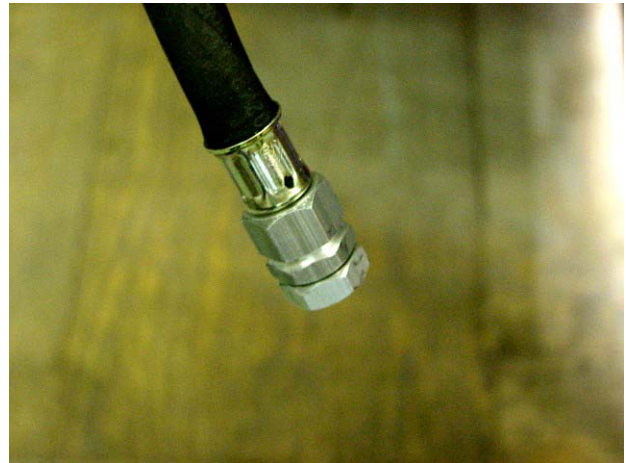
### 3. Open oil drain screw.

Unscrew the oil drain screw by means of the open-ended wrench from the oil drain hose (rotating direction left). Use a second open-ended wrench to lock. Make sure to do this over the container.

Use spanner size 17 mm.



Fig. 7.9-2: Oil drain hose



### 4. Discharge used oil.

Let the entire amount of oil drain out of the engine. This can take several minutes.

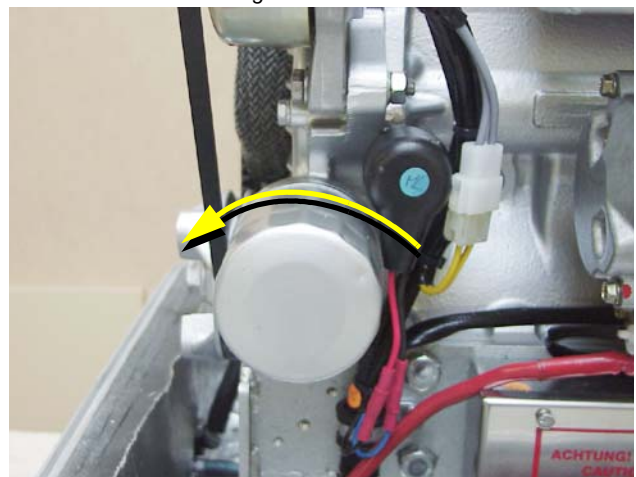
### 5. Remove used oil filter / clean oil screen

Release the oil filter by turning the filter wrench counterclockwise. The filter might be full of oil. Make sure to not spill anything and avoid skin contact.

Sample picture



Fig. 7.9-3: Oil filter



**Oil screen with generators with EA300 engines**

The oil screen should be cleaned every 500 operating hours: to do so follow the instructions in the engine manual.

Use spanner size 17 mm.



Sample picture

Fig. 7.9-4: Oil screen



6. Preparing a new filter

Clean the engines' filter holder brush a thin oil layer on the sealing of the new filter.

Fig. 7.9-5: Oil screen sealing ring



7. Mounting the new filter

Carefully screw in the new filter by hand. It must not be tightened too much. Screw in the oil drain screw again and tighten is with the wrench. Use a new sealing for the oil drain screw.

8. Fill in oil. (oil fill capacity: see attachment)

Fill the engine oil into the engine via feed hopper. Check oil-level after every 2 litres with the oil dipstick.

9. Check proper filling level. See section 7.8, "Checking oil-level," on page 107.

When the proper filling level is reached, screw in the oil cap again. Run the engine for 10 minutes and then turn it off. Check the oil-level once more after several minutes with the oil dipstick. If it is too low, refill some oil.

10. Clean up

Wipe off all oil splashes from the generator and make sure that the drain screw has no leak.

**7.9.1 After the oil change**

- Put the oil dipstick back into the check rail.
- Close the oil filling cap.
- Remove potential oil stains and splashes from the generator and surroundings.
- Close the generator casing.
- Remove lock against accidental generator start.
- Duly dispose of used oil and filter.

Used oil is very toxic and must not be disposed with domestic waste. It is prohibited to dispose used oil with waste water! Make sure that used oil is disposed properly (e.g.: where oil is bought or at collection stations).

## 7.10 Verifying the starter battery and (if necessary) the battery bank

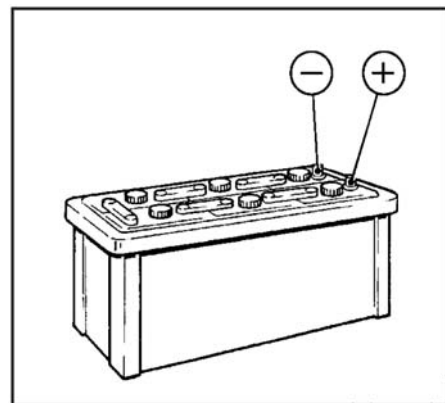
Check the condition of the battery. Proceed here as prescribed by the battery manufacturer. If from the battery manufacturer not otherwise mentioned.

### 7.10.1 Battery

#### 7.10.1.1 Check battery and cable connections

- Keep battery clean and dry.
- Remove dirty clamps.
- Clean terminal posts (+ and -) and clamps of the battery, and grease with acid-free and acid-resistant grease.
- When reassembling, ensure that clamps make good contact. Tighten clamp bolts hand-tight.

Fig. 7.10.1.1-1: Battery

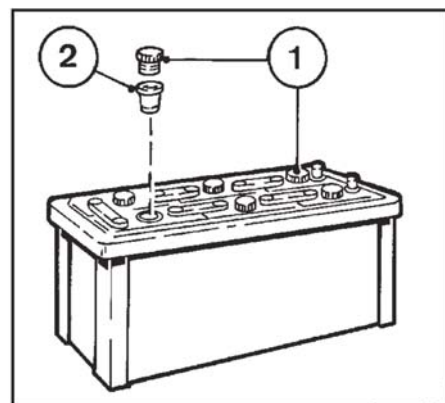


Leere Seite / Intentionally blank

#### 7.10.1.2 Check electrolyte level

- Remove sealing caps 1.
- If testers 2 are present:
- Electrolyte level should reach the base of these.
- Without testers:
- The electrolyte level should be 10-15 mm above the top of the plates.
- If necessary, top up with distilled water.
- Screw sealing caps back in.

Fig. 7.10.1.2-1: Battery

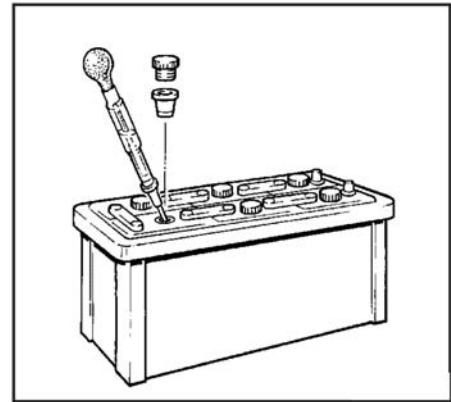




### 7.10.1.3 Check electrolyte density

- Measure the electrolyte density of individual cells with a commercial hydrometer. The hydrometer reading (see table on following page) indicates the battery's state of charge. During measurement, the temperature of the electrolyte should preferably be 20 °C.

Fig. 7.10.1.3-1: Battery



Electrolyte density		
in [kg/ l]		Charge status
Normal	Tropical	
1.28	1.23	well charged
1.20	1.12	semi-charged, re-charge
1.12	1.08	discharged, immediately charge

The gases emitted by the battery are explosive! Keep sparks and naked flames away from the battery!

Attention



Do not allow battery acid to come into contact with skin or clothing!

Wear protective goggles!

Do not rest tools on the battery!

Leere Seite / Intentionally blank

## 8. Generator Failure

### 8.1 Personal requirements

---

The work described here, unless otherwise indicated, are performed by the operator.

More Repair work may be performed only by specially trained personnel or by authorized repair shops (Fischer Panda service points). This is especially for working on the valve timing, fuel injection system and the engine repair.

### 8.2 Hazard notes for the troubleshooting

---

**Follow the general safety instruction at the front of this manual.**

**Notice!**



**Danger for life! - The generator can be equipped with an automatic start device. This means the generator can be started by an external signal. To avoid an unexpected starting of the generator, the starter battery must be disconnected before start working at the generator.**

**Warning!: Automatic start**



**Working at a running generator can result in severe personal injury. Therefore before starting work at the generator:**

**Warning!: Risk of injury**



Make sure that the generator is stopped and the starter battery is disconnected to guarantee that the generator cannot be inadvertently started.

Do not run the generator with removed sound isolation cover.

**Improper installation/maintenance can result in severe personal injuries or material damage.**

**Warning!: Risk of injury**



- Always undertake installation/maintenance work when the generator is switched off.
- Ensure there is sufficient installation clearance before start working.
- Ensure tidiness and cleanliness at the workplace. Loose components and tools lying around or on top of each other are sources of accidents.
- Only perform installation work using commercially available tools and special tools. incorrect or damaged tools can result injuries.

**Oil and fuel vapours can ignite on contact with ignition sources. Therefore:**

**Warning!: Danger of fire**



- No open flames during work on the generator.
- Do not smoke.
- Remove oil and fuel residues from the generator and floor.

**Contact with engine oil, antifreeze and fuel can result in damage to health. Therefor:**

- Avoid skin contact with engine oil, fuel and antifreeze.
- Remove oil and fuel splashes and antifreeze from the skin immediately.
- Do not inhale oil and fuel vapours.

**Danger for Life. Improper handling, operation, installation and maintenance can result in severe personal injury and/or material damage.**

Electrical voltages above 48 volts (battery chargers greater than 36 volts) are always dangerous to life). The rules of the respective regional authority must be adhered to. Only an electrician may carry out installation of the electrical connections for safety reasons.

**Generator, oil and antifreeze can be hot during/after operation. Risk of severe burns.**

**During Installation/maintenance personal protective equipment is required to minimize the health hazards.**

- Protective clothing
- safety boots
- protective gloves
- Ear defender
- safety glasses

**Disconnect all load during the work at the generator to avoid damages at the load.**

**Danger!: Danger of poisoning**



**ATTENTION!: Danger to Life - High voltage**



**Warning!: Hot surface/material**



**Instructions!: Personal protective equipment necessary.**



**Attention!: Disconnect all load**



## 8.3 Tools and measuring instruments

---

---

In order to be able to manage disturbances while driving, following tools and measuring instruments should belong to the equipment on board:

- Multimeter for voltage (AC), frequency and resistance
- Measuring instrument for inductance
- Measuring instrument for capacity
- Current absorbing clamps
- Thermometer (ideal is a infrared thermometer)
- Pressure device (pincer) for coolant circuit

## 8.4 Overloading the Generator

---

---

Please ensure that the genset is not overloaded. This is especially the case with multi-power aggregates. Overloading occurs when the electrical load (demand) induces a load torque in the generator which is higher than what the diesel drive motor can provide. Overloading causes the engine to run rough, burn oil, create excessive exhaust (environmentally unfriendly) and even to stall.

The generator should only be loaded at the peak rated power for short periods only! A high peak current is required to start many electrical devices, especially electric motors and compressors (from a still stand state).

In order to prolong the gensets life expectancy, the nominal electrical demand on the system should not be more than 70 % of the rated genset power.

Bear this in mind when switching on electrical devices. This ensures a longer life expectancy.

Continuous performance is the uninterrupted running of the generator for many hours. The genset can be run for several hours at partial load (i.e. 2/3 of rated power), however it is not advised that it is run for more than 2-3 hours at full load.

The Panda is designed so as not to overheat even under extreme conditions. Note: The exhaust gas will become sooty during peak-load operation.

### 8.4.1 Effects of Short Circuiting and Overloading on the Generator

---

The generator cannot be damaged by short circuiting or overloading. Short circuiting and overloading suppress the magnetic excitation of the generator, thus, no current is generated and the voltage will collapse. This condition is immediately offset once the short-circuit has been eliminated and/or the electrical overload removed.

### 8.4.2 Overloading the Generator with Electric Motors

---

Please note that electric motors require six to ten times more power than their rated capacity to start.

If the supplied generator power is lower than what the electric motor requires, the generator voltage will collapse. For applications where a high current draw is required to start an electrical device (such as an electric motor), the motor manufacturer should be consulted for possible solutions (for example: stronger capacitors, gradual power-up switches, or a specially designed starting unit for electric motors).

System efficiency can be improved by up to 50 % and motor current draw (to start) reduced by as much as 100 % if it is properly designed. If the inductive load (i.e. E-Motor) is more than 20 % of the generator nominal power, a compensation is necessary. See also the information brochure „Special information for operation of Panda generators with inductive load“.

### 8.4.3 Generator Voltage Fluctuations and Monitoring

---

Before working (installation) on the System read the section Safety Instructions in this Manual.

Notice!:



During periods of high electric loading, the voltage may drop to 190 V/50 Hz (or 95 V/60 Hz) or even lower. Such voltage drops can potentially cause damage to certain electrical devices such as electric motors, compressors and electronic equipment. In order to ensure that sufficient voltage is available and to avoid the risk of damage to sensitive electrical devices, the supply voltage should be monitored with the voltmeter, which is mounted at the operation unit.

The voltmeter must be respectively checked if additional load is switched on. As long as the voltage remains below the critical level the sensitive devices must be switched off during this period.

Over voltage can be caused by the generator under certain circumstances. This occurs, especially if the speed of the motor changes (increases in speed). Adjustment to the normal motor speed (rpm) should only be done with the use of a rev counter and/or a voltmeter.

A voltage regulated circuit breaker is installed in the electrical system in order to avoid damage, if sensitive or valuable equipment is used. (voltage control with circuit breaker).

### 8.4.4 Automatic Voltage Monitoring and Auto-Shut Down

---

If air conditioning units (compressors) or other such valuable equipment are installed on-board, an automatic voltage monitoring unit should be installed to protect this equipment from possible sharp voltage drops. The voltage monitoring system shuts down the entire system (and therefore all users) through a circuit breaker relay as soon as the voltage falls below a set value (the monitor will also shut down the on board grid automatically when the generator is stopped). The monitoring system also switches the grid back on once the required voltage level is again reached. This ensures no damage is caused to the load and fittings through under voltage. Such a voltage relay can be obtained from wholesale dealers or as a complete unit from PANDA dealers.

The circuit is always automatically cut off if the generator is stopped.

## 8.5 Low Generator-Output Voltage

---

---

If the produced alternating voltage is too low, switch the consumers off, in order to relieve the generator. Mostly the problem already solved. If the output voltage is still too low, even if all consumers are switched off, the generator runs without load, you can assume one or more condensers are defective.

### 8.5.1 Discharge the capacitors

---

Never work at the electrical cabinet, when the generator is running! Do not contact the capacitor. Before working on the system read the section "Safety first!" on Page 12.

ATTENTION!



- 1) Switch off generator
- 2) Disconnect starter battery
- 3) Open AC-Control box



Fig. 8.5.1-1: Capacitor



The capacitors are discharged, by short circuit the two contacts. In addition use the cone end of an isolated screwdriver.

### 8.5.2 Checking the Capacitors

Before working (installation) on the System read the section „Safety Instructions“ in this Manual.

**ATTENTION!**

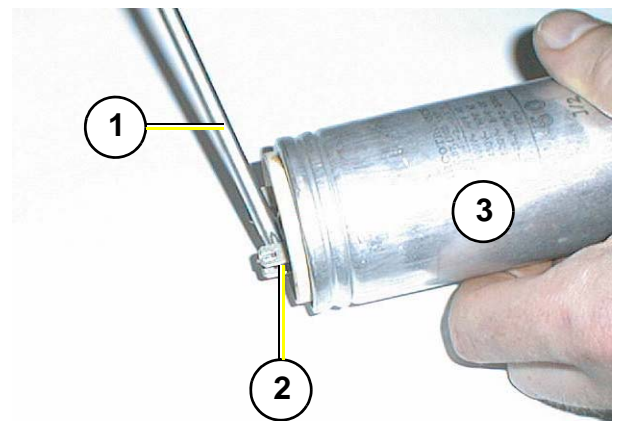


Do not check the capacitors whilst the generator motor is running! Charged capacitors can be lethal. Do not contact the capacitors with bare fingers or non-insulated metallic objects! In order to test the capacitors, the terminal lead wires have to be disconnected using pliers or a screwdriver with insulated handle(s). Once the wires have been removed, the capacitors must be discharged by bridging the capacitor terminals together with a slot screwdriver with an isolated handle.

#### Discharge the capacitor

1. Screw driver blade
2. Capacitor connections
3. Capacitor

Fig. 8.5.2-1: Capacitor



The capacitors can be checked using a normal multimeter with a continuity beeper. Check that the multimeter „beeps“ when the selector is set to continuity and the end probes are contacted together.

## Checking

Switch the multimeter to „Continuity: acoustic signal“ and touch both capacitor terminals with the meter end probes.

Fig. 8.5.2-2: Capacitor



Test each capacitor by touching the multimeter (set on „continuity“) end probes on the capacitor terminals: only a brief „beep“ should be audible from the multimeter.

Once this has been done, reverse the end probe positions and repeat the check. (The multimeter battery charges the capacitor and then the capacitor discharges quickly. The discharge to the multimeter „closes“ the circuit briefly and continuity is achieved for a brief instant causing the short „beep“.)

If there is no beep at all or there is a continuous beep, then the capacitor(s) is faulty and needs to be replaced.

Inductance is measured in the same way as the ohmic resistance, i.e. the coils are compared. The value is indicated in mH (milli Henry).

The arranging value for the inductive resistance can take from the Table 9.4, “Technical data coil,” on Page 129.

Note: These values depends strongly from the measuring method (kind of the measuring instrument)



## 8.6 Testing generator stator windings

---

### 8.6.1 Checking the generator voltage

---

In order to test, whether the fixed winding produces enough voltage, proceed in such a way:

1. Guarantee that the connection to the electrical system is interrupted.
2. Remove all conductions in the power terminal box of the generator.
3. Starter battery must be connected with the generator.
4. Start the generator start.
5. Measure with a voltmeter the voltage between the phase(s) and N. If the measured values are under the substantially values in Table 9.4-5, "Voltage values stator coil," on Page 130, a coil damage is to be accepted.

During the measurement in the 60 Hz version both partial coils must be interconnected, i.e. a connection must be provided between line 1 and line 3. (see wiring diagram)

*(notes: the voltage results from the remainder magnetism of the rotor, which induced a voltage in the coil.)*

### 8.6.2 Measuring the coil resistance

---

**For this a measuring instrument must be used that is suitable for low impedance values.**

- Adjust the measuring instrument to resistance test. If hold the poles of the measuring instrument hold together, 0.00 ohms should be indicated. If the poles are isolated, the display should indicate an overflow. Please implement this test, in order to examine the equipment.
- Measure of the resistance within the individual windings.

If strong deviations in the individual coils are measured, must assumed that there is a coil short-circuit in a coil. This leads to the fact that the generator does not excite itself any longer.

The actual values between the coils and ground are not to be determined exactly. It depends primarily on the fact that the values of all three measurements are close to the same. Deviations among themselves refer to a coil short-circuit. In this case the generator must be wound again by a specialist.

### 8.6.3 Checking the coil(s) to short-circuit

---

In order to check the coils for short-circuit, first all lines, which lead to the electrical system, must be interrupted. This happens on the power terminal box of the generator or, if available, in the electrical system junction box. Guarantee that no voltage lies at the lines, before they are interrupted (see "Discharge the capacitors" on Page 118.).

Now remove the bridge between „N“ and „PE“, so that coils and housing are electrically separate from each other.

Check with a circuit indicator (multimeter) in the power terminal box if between the individual connection points of the coil and the housing (PE) a pass exists.

The contacts which can be measured depend on the type of the generator (see identification plate):

HP1 - 50 Hz: L, Z

HP1 - 60 Hz: L, Z

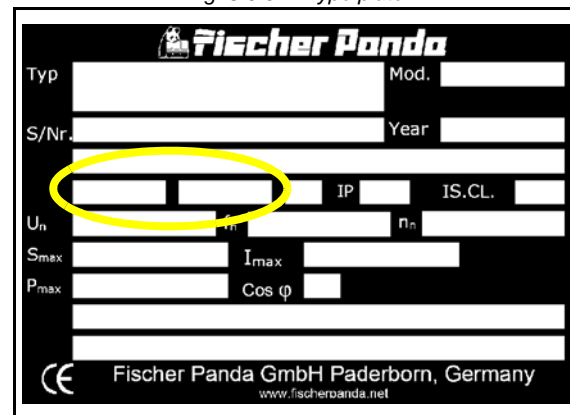
HP3 - 50 Hz: L1, L2, L3

HP3 - 60 Hz: L1, L2, L3, 1, 2, 3, 4

DVS - 50 Hz: L1, L2, L3, L1'

DVS - 60 Hz: L1, L2, L3, L1', 1, 2, 3, 4

Fig. 8.6.3-1: Type plate



If a pass (beep) should be determined, the generator must be returned for examination in the plant, or it can also be wound again locally. For this coil data can be requested.

### 8.6.4 Measuring the inductive resistance

Unfortunately the checking of the ohmic resistance permits still no reliable statement about the condition of the coil. If the ohmic resistance values arise inequalities between the coils, that is a safe indication for the fact that the coil is defective. To be exactly sure the inductive resistance of the coil have to be measured. For this a special measuring instrument is necessary, which measures the inductance of a coil.

### 8.6.5 Testing generator stator winding for „shorts“ to ground

If no faults are found with the capacitors and the generator is still not performing correctly, the generator stator windings must be tested for „shorts“ to ground as follows:

1. Ensure that the generator is „OFF“ and cannot be accidentally started. Disconnect the battery.
2. Remove AC output terminal box lid (mounted on generator casing).
3. All terminal box connections are to be removed. (See appropriate circuit diagram.)
4. Remove all cables (also earth lead).
5. A check of the generator terminal box is made by means of a multimeter to determine whether there is continuity between the individual windings connections and ground.

If continuity is detected for any of the combinations, the generator must be sent to the factory for inspection and repair. If this is not possible, the stator can be rewound by a qualified trades person/technician. Winding diagrams can be obtained from Fischer Panda GmbH, Germany.

This test, unfortunately, is carried out at very low voltage (9 V) when a normal multimeter is used. Therefore only positive short circuits will be displayed. There is the possibility that a short circuit will occur in spite of a negative test result (i.e. moisture). A reliable check can only be carried by using an essentially higher voltage (approx 500 V). This type of measuring instrument is normally only used by experts.

If in doubt an electrician must check the winding for a short circuit with an isolation meter.

**Generator Power Terminal Box 230 V / 50 Hz**

In these terminal box there are the electrical connection points for the AC generator. Here is also the bridge for the protective grounding of the generator. The cover may only be removed, if it is guaranteed that the generator cannot be inadvertently started.

*representative picture*

Fig. 8.6.5-1: Generator output terminal box 230 V / 50 Hz

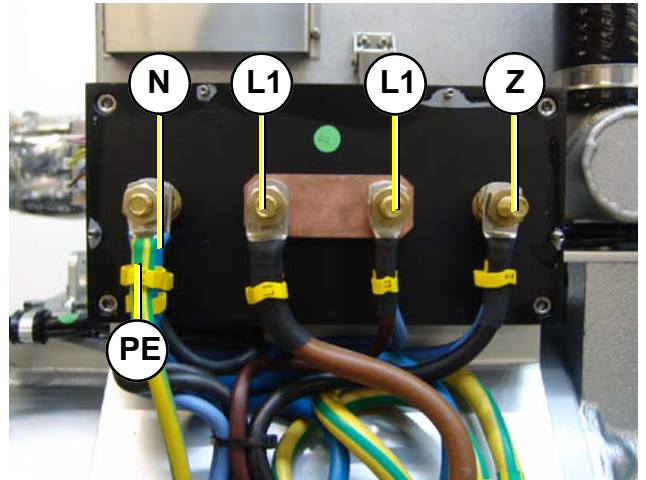
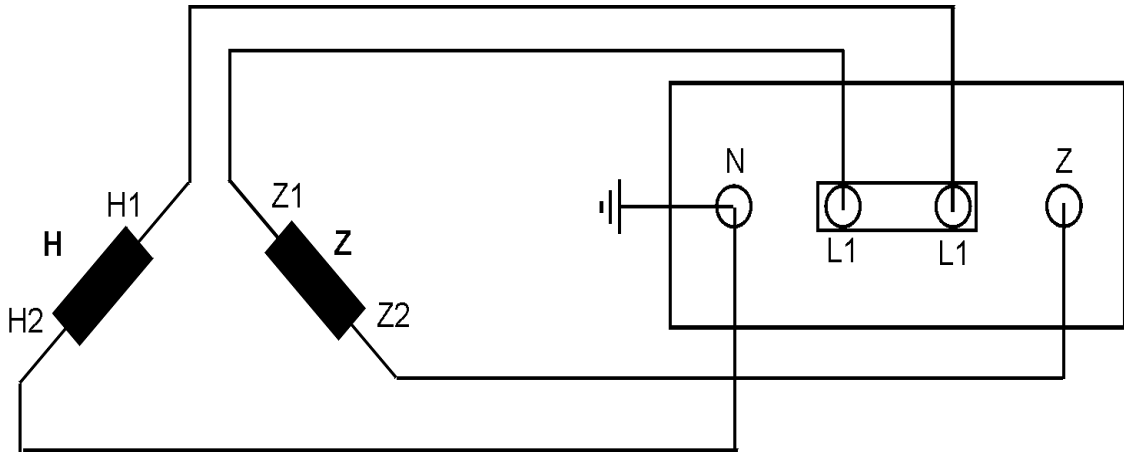


Fig. 8.6.5-2: Wiring diagram HP1 - 230 V / 50 Hz



**Generator Power Terminal Box 400 V / 50 Hz**

In these terminal box there are the electrical connection points for the AC generator. Here is also the bridge for the protective grounding of the generator. The cover may only be removed, if it is guaranteed that the generator cannot be inadvertently started.

*representative picture*

Fig. 8.6.5-3: Generator Power Terminal Box 400 V / 50 Hz

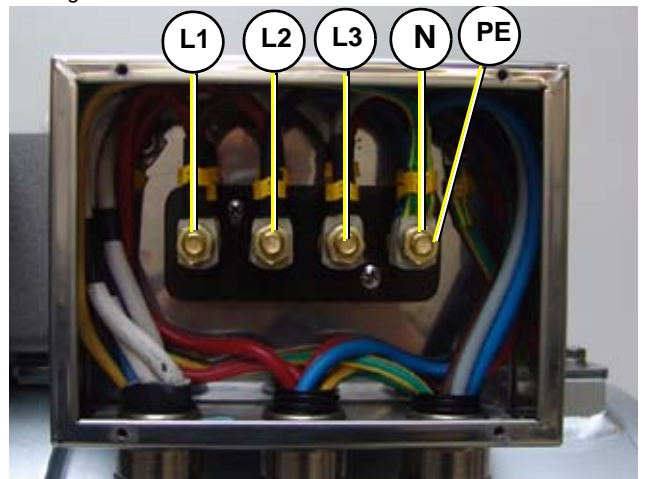
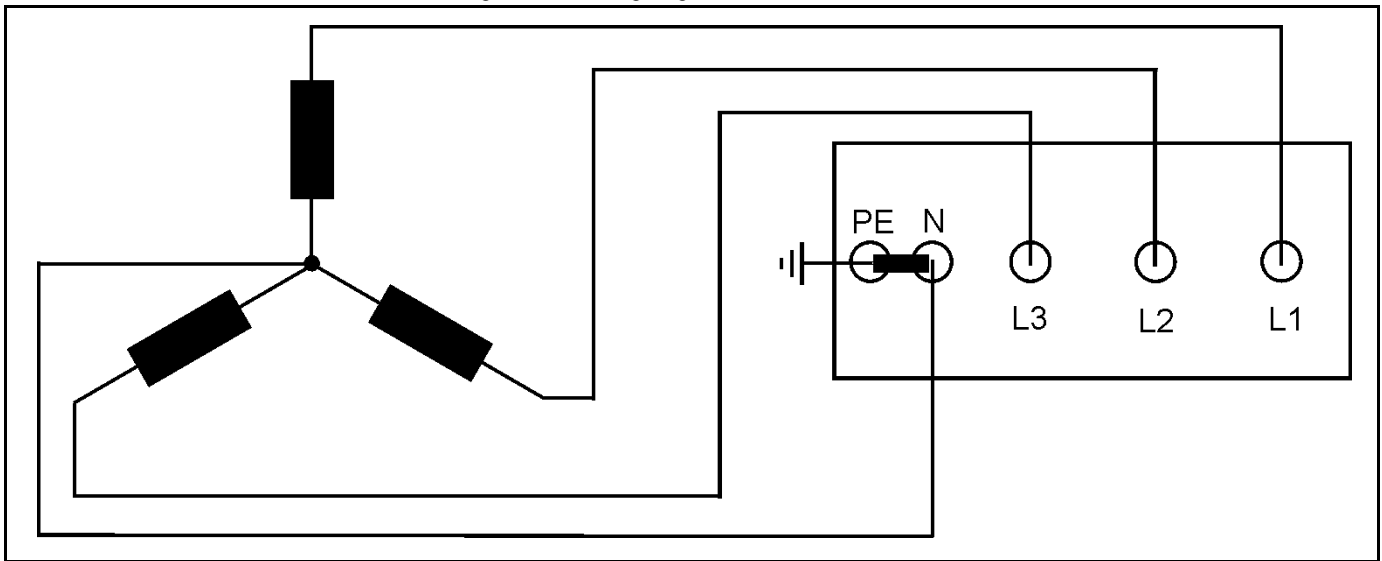




Fig. 8.6.5-4: Wiring diagram HP3 - 400 V / 50 Hz



**Generator Power Terminal Box 120 V / 60 Hz**

In these terminal box there are the electrical connection points for the AC generator. Here is also the bridge for the protective grounding of the generator. The cover may only be removed, if it is guaranteed that the generator cannot be inadvertently started.

representative picture

Fig. 8.6.5-5: Generator power terminal box 120 V / 60 Hz

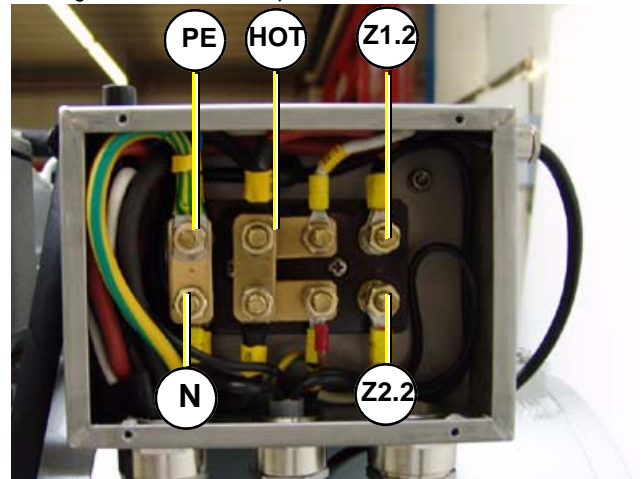
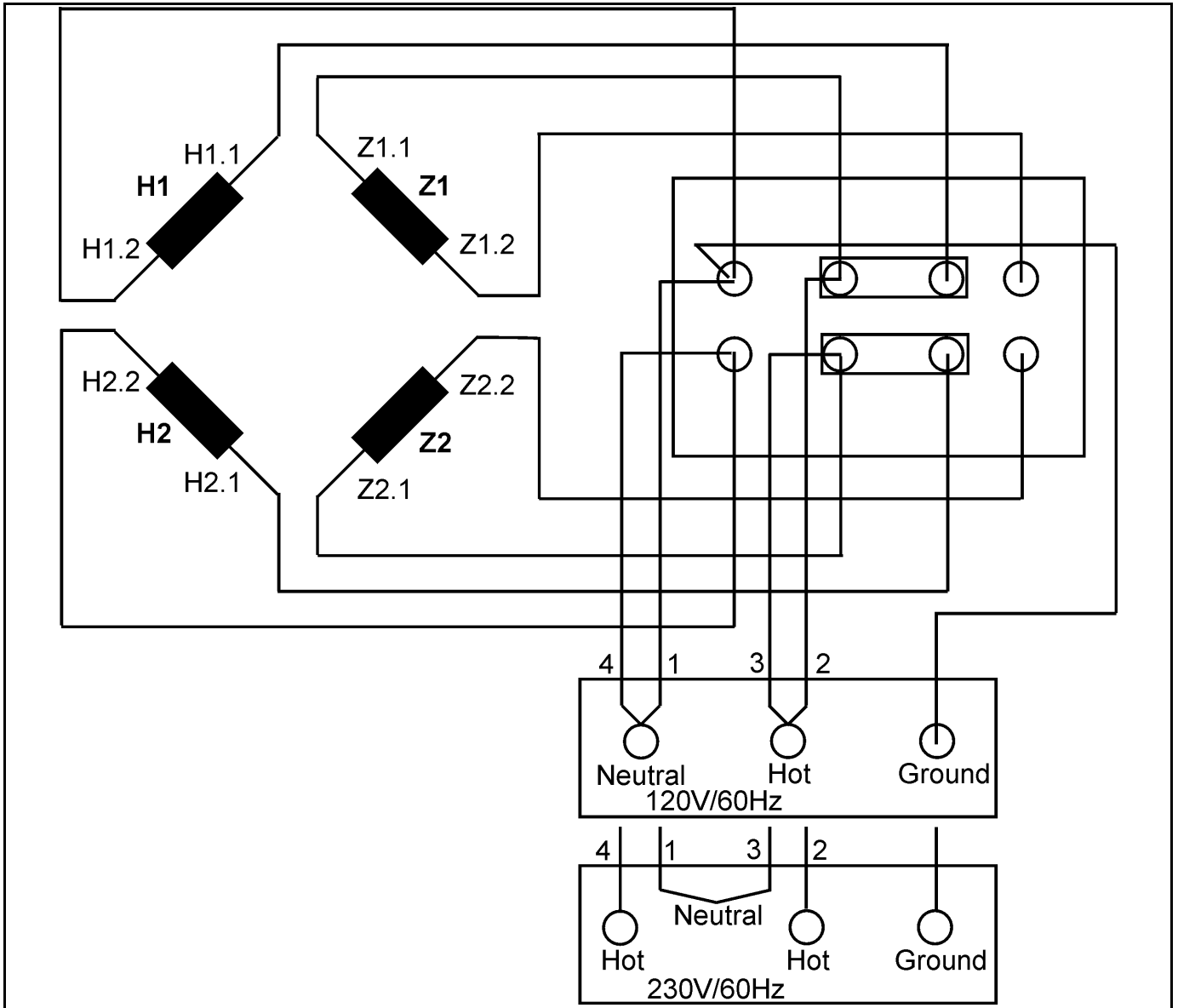


Fig. 8.6.5-6: Wiring diagram HP1 - 120 V / 60 Hz



**Generator Power Terminal Box 240 V / 60 Hz (208 V / 60 Hz)**

In these terminal box there are the electrical connection points for the AC generator. Here is also the bridge for the protective grounding of the generator. The cover may only be removed, if it is guaranteed that the generator cannot be inadvertently started.

*representative picture*

Fig. 8.6.5-7: Generator power terminal box 240 V / 60 Hz

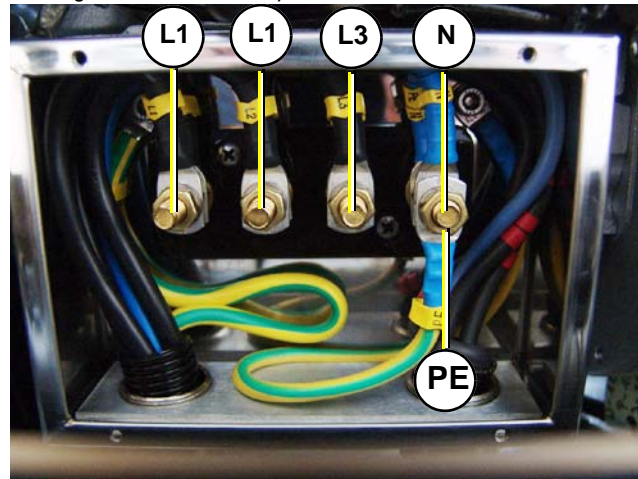
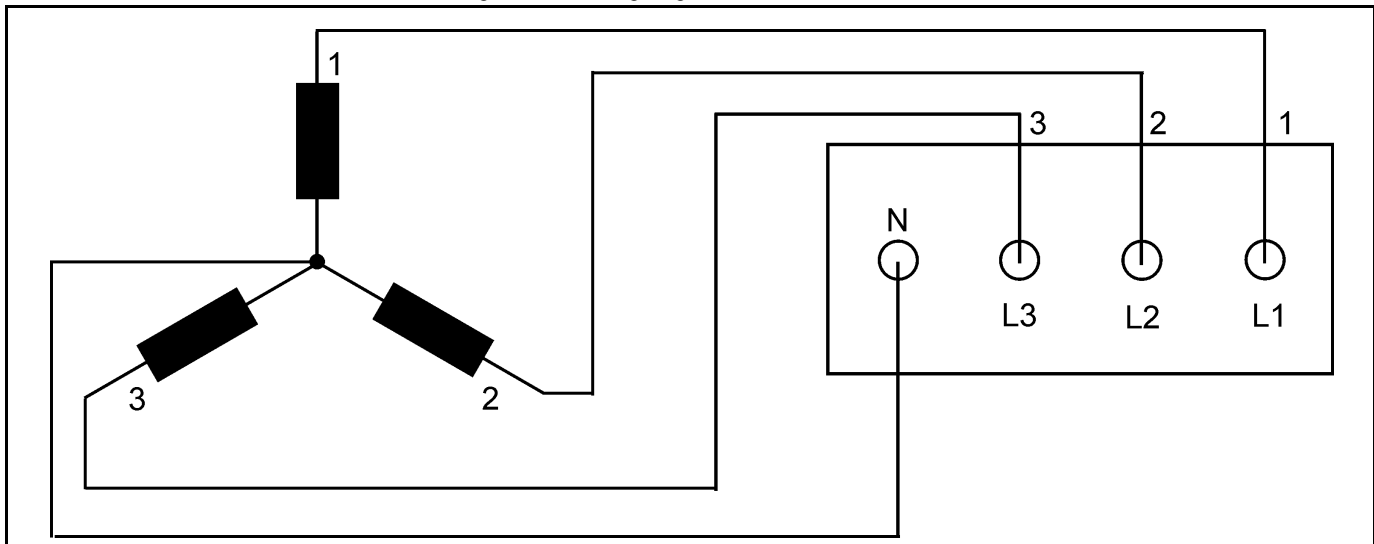


Fig. 8.6.5-8: Wiring diagram HP3 - 240 V / 60 Hz



**Generator Power Terminal Box DVS - 120 V + 240 V / 60 Hz**

In these terminal box there are the electrical connection points for the AC generator. Here is also the bridge for the protective grounding of the generator. The cover may only be removed, if it is guaranteed that the generator cannot be inadvertently started.

*representative picture*

Fig. 8.6.5-9: Generator power terminal box DVS

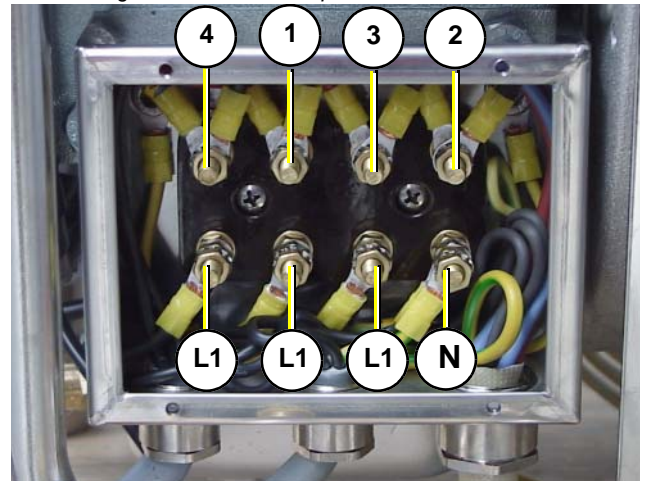


Fig. 8.6.5-10: Wiring diagram DVS - 120 V + 240 V / 60 Hz

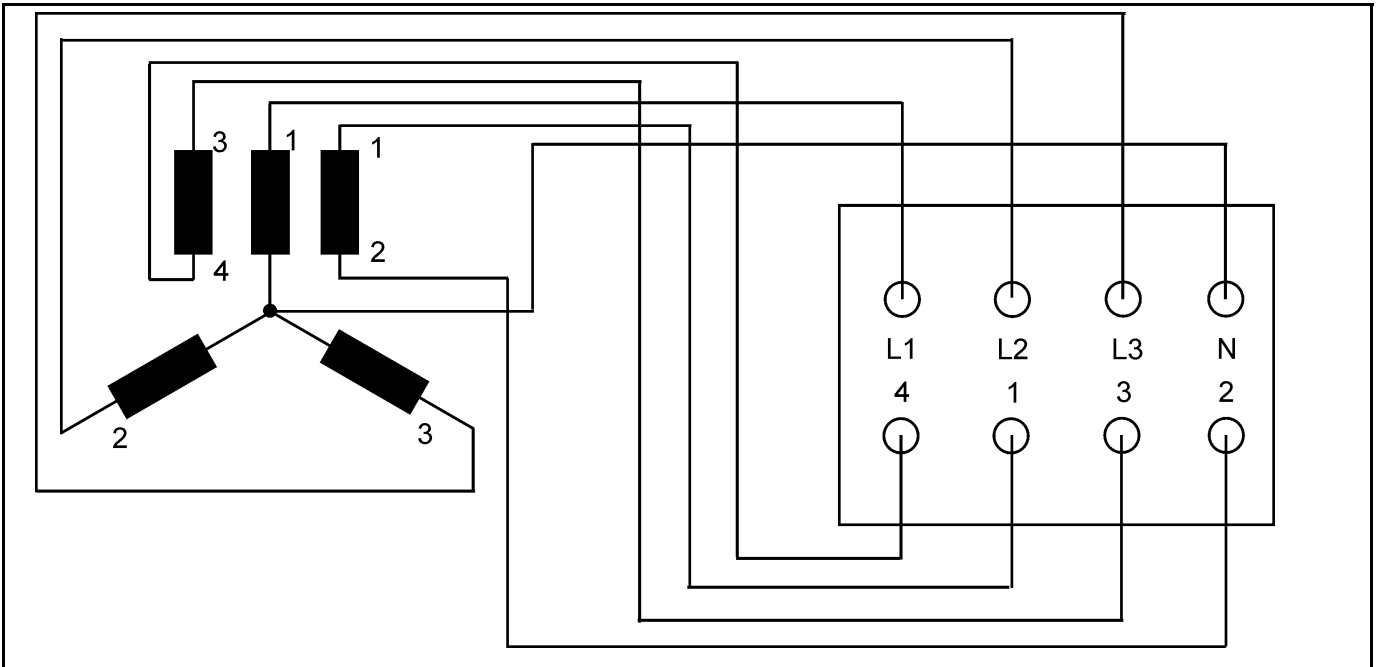
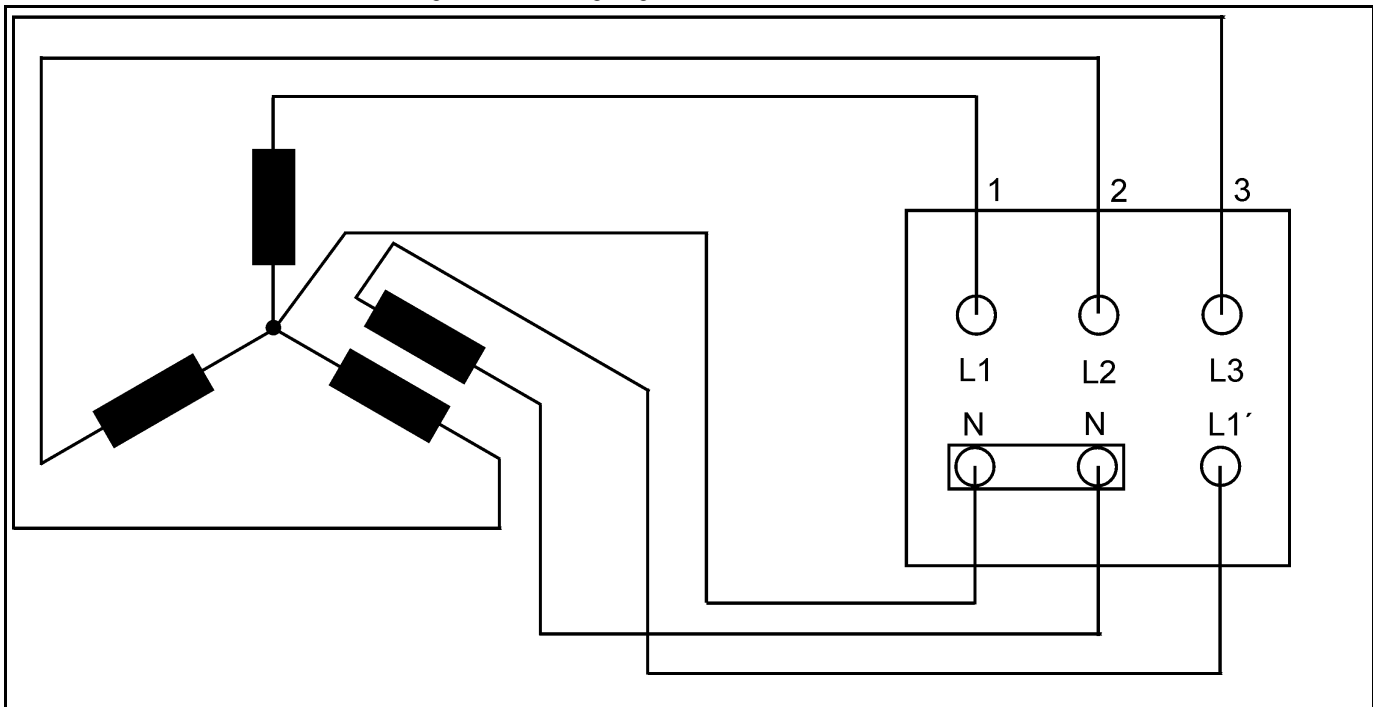




Fig. 8.6.5-11: Wiring diagram DVS - 230 V + 400 V / 50 Hz



### 8.6.6 Coil Resistance Measurements in Stator Windings

When there are neither faults with the capacitors nor any low or high voltage „shorts“ in the windings to ground, the windings should then be tested for the correct coils resistance (for shorts between wires within the coils). To measure coil resistance a meter capable of measuring low resistances (Milli-Ohm resolution if possible) accurately.

#### 8.6.6.1 Checking windings.

- Disconnect all the cables from the terminals in the AC-connection box.
- Remove the Neutral- Ground connection.
- Take all the winding connection cables from the terminal bolts.
- Switch your meter in resistance range. When you put the probes of you meter together, you should get a reading of 0.00 Ohm. When you isolate the probes, the reading will be Overflow. Please do this tests to check your meter.
- Measure the resistance between the separate windings. Maybe the readings of your meter do not comply with the values of the table in the appendix. In every case the relation between the values should be the same. Some meters do not work fine, when values are very small.
- Measure the resistance between the different windings. When you find a value in the 20 Mega- Giga Ohm range, the winding is ok.
- Measure the resistance between the different windings and housing of the alternator. Here you should also find a value in the Giga-Ohm range. When the winding is shorted to ground, maybe you are not able to measure this, because the voltage of your meter is a few volts. In this case to get a save reading, use a MEGA-meter with a high test voltage

If you find any abnormality, when doing this test, please ask your Fischer Panda dealer.

If the measured resistance values deviate from each other significantly, then there is probably a short within the coils. A short within the coils can prevent the generator from achieving the required excitation and therefore from reaching the rated power output. The values listed in the above table, represent the approximate range of acceptable resistances. Most important is that the measures values do not deviate significantly from one another. Large resistance value deviations between phases indicate a short-circuit in the windings. In this case the generator must be newly wound by a qualified technician.



## 8.7 Measuring the Coil Inductive Resistance

---

Unfortunately a reliable assessment of the winding's performance cannot be attained through checking only coil resistances. However, the symmetry of the coil resistances is a good indicator of winding performance. If the coil resistances are symmetric, the next step is to measure the winding's inductive resistance using a special meter (capable of measuring milli-Henrys).

The coil induction is measured and compared in the same manner as the electrical resistance (i.e. the windings are compared for symmetry). These parts must have the same values.

Note: These values strongly depend on the method of measurement (e.g. used instruments)

**An alternative test method to check the stator windings can be performed as follows:**

1. Ensure that the connection to the circuit system is disconnected.
2. All electrical wires in the generator terminal box must be disconnected.
3. Reconnect the battery connections.
4. Start the generator.
5. Measure the voltages between the following terminals and compare for symmetry: L1-N, L1-Z.

## 8.8 Generator provides no Voltage

---

### 8.8.1 Rotor Magnetism Loss and „Re-magnetizing“

---

After having stood idle for a longer period of time, or after having been shut down abruptly from operating under a heavy electrical load, most asynchronous generators have difficulties achieving full excitation independently. The remaining rotor magnetism is lost.

**Before working on the System read the section „Safety Instructions“ in this Manual. Notice!:**



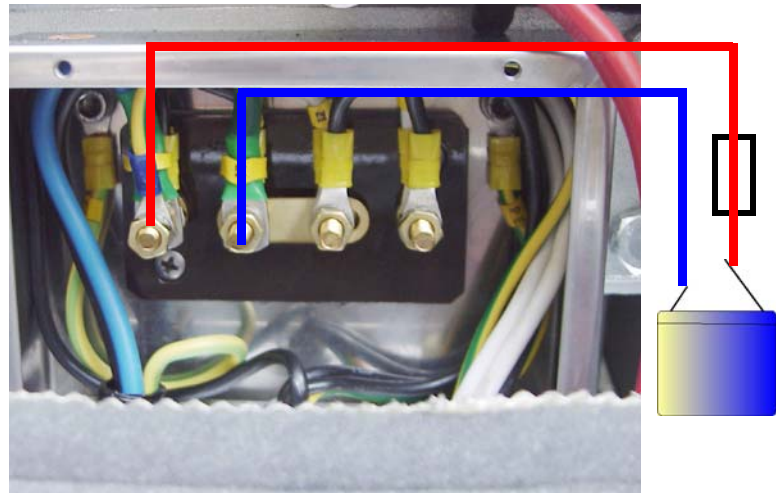
The magnetism required for excitation can be easily restored using a simple DC Battery. The generator must be stopped to do this, that means the starter may not be actuated. DC is fed to a desired part of the winding from the exterior for a short period. This can, for example, be carried out for by feeding DC to the windings from both terminals of a 230 V (115 V) socket of the vehicles system. (This, of course, can only happen if there is no connection to any power source). There must be a connection between socket and the generator (see diagram below). It suffices if DC is applied for a short period (1-2 seconds). The remaining magnetism can be restored and the generator can be started in the normal manner again.

**Before this procedure is performed to restore the magnetic field, it is crucial to ensure that the generator is not running! (otherwise, it is very DANGEROUS TO LIFE!)**

**ATTENTION!**



Fig. 8.8.1-1: Generator termination box



Initializing the magnetic field in the windings through external current from a 4,5 - 9 volt battery. (No car-battery!)

### 8.8.2 Stop solenoid

There are two different variations:

#### A. Energized to stop

By pressing the „OFF“-button on the remote control panel the stop solenoid is supplied with voltage and operate, through this the injection nozzles resets to zero position and the generator stops.

#### B. Energized to run

This version is equipped with two solenoids an actuating and a stop solenoid. After being fed with current, the actuating solenoid attracts the adjusting lever of the fuel injection pump, through which the fuel can flow. The actuating solenoid is switched off once the final position has been reached, which is maintained by the stop solenoid for as long as the generator is running

**When starting the „START“-button may not be pressed longer than 5 sec., because the stop solenoid pulls too much current over the starter. Otherwise the stop solenoid must be disconnected.**

**.Notice!:**



#### Stop solenoid (optional)

Fig. 8.8.2-1: Stop solenoid



### 8.8.3 Damage to starter motor

---

The starter is fitted with a free wheel or axial rotating spring cog, which prevents the starter being driven externally by means of the motor. The free wheel will be heavily worn, if the starter still operates, thereby causing damage to the springs, roller bearings or cog teeth. This could lead to complete destruction of the starter.

**It is important that every person who operates the generator is informed of this situation. This is practically the only handling error that can be made on board that can lead to fatal consequences for both generator and operator.**

## 8.9 Troubleshooting Table

### 8.9.1 Generator faults

#### 8.9.1.1 Generator output too low. For 50 Hz versions: less than 200 V. For 60 Hz versions: less than 100 V.

Cause	Solution
Generator is overloaded.	Reduce the electrical load. (Switch off load)
Motor is not reaching the rated rpm.	Refer to „motor faults“ section.
Defective capacitor(s).	Check capacitors and replace if necessary.

#### 8.9.1.2 Generator voltage too high (more than 240 V-50 Hz / 135 V-60 Hz). If the generator is providing excessively high voltage, the following potential causes should be investigated:

Cause	Solution
Over-energizing due to wrong capacitors.	Check capacitors type and replace if necessary.

#### 8.9.1.3 Generator voltage fluctuates.

Cause	Solution
1. Disturbances on the electrical system/user side.	1. Check if electrical load is fluctuating.
2. Motor disturbances.	2. Refer to section: „Motor runs irregular“.

#### 8.9.1.4 Generator is not able to start an electric motor.

Cause	Solution
If the generator is unable to supply enough power to start an electric motor (120V-60Hz or 231V-50Hz), it is usually because the motor draws too much current during the starting process.	Check the motor's current draw required for starting (switch to 380V if possible). This could be remedied by providing stronger capacitors or installing an optional „Easy Start Booster Set“. (See Apt. G) Enquire at your nearest Panda dealer or directly at the manufacturer.

#### 8.9.1.5 Diesel motor fails to start

Cause	Solution
Starter battery switched „OFF“.	Check position of battery switch and switch „ON“ (if installed).
Starter battery voltage insufficient (battery too weak).	Inspect battery terminals and cables for a good electrical connection (Inspect against corrosion, tattered wires, etc.).
Starting current disrupted.	During the normal starting process, the battery voltage drops to 11V with a fully charged battery. If the voltage does not drop during starting, the electrical connection is faulty. If the battery voltage drops lower than 11V, then the battery has been discharged.

### 8.9.1.6 Starter motor is turning the engine, but generator fails to start.

Cause	Solution
Fuel inlet solenoid valve not opening.	Check wire connections and circuitry to solenoid valve. (ref. DC wiring diagram: Relay K2, Fuse)
Fuel pump not working.	Check fuel-filter and pump: clean if necessary.
Lack of fuel.	Check fuel supply.
Glow-plugs not working correctly.	Check glow plugs and heating time.
Too much air in fuel lines.	Test fuel system for leakage. Bleed air from fuel system (refer to section „Bleeding Air from Fuel System“).
Fuel-filter blocked.	Replace fuel filter.
Low compression pressure.	See motor-manual.

### 8.9.1.7 Motor does not achieves enough speed during starting process.

Cause	Solution
Starter battery voltage insufficient.	Check battery.
Damaged bearing(s) piston (seized).	Repairs need to be carried out by engine manufacturer-Service. (refer to motor-manual)
Cooling water in combustion chamber.	<ol style="list-style-type: none"> <li>1. Turn generator „OFF“ at control panel.</li> <li>2. Remove the glow plug (see engine-manual).</li> <li>3. Rotate the motor by hand carefully.</li> <li>4. Check if there is water in the oil and change both oil and filter if necessary.</li> <li>5. Determine cause for excess water in the combustion chamber. The excess water can be caused by a defective air vent in the cooling water system, which should be checked and cleaned, or replaced if faulty.</li> </ol>

### 8.9.1.8 Motor runs irregular

Cause	Solution
Faulty centrifugal injector governor.	Have the centrifugal governor inspected by a motor manufacturer-Service technician.
Too much air in fuel lines.	Bleed air from fuel system.

### 8.9.1.9 Motor speed drops.

Cause	Solution
Lack of fuel	Check fuel supply system: <ul style="list-style-type: none"> <li>- fuel filter, renew if necessary</li> <li>- check fuel pump</li> <li>- check fuel lines (bleed if necessary)</li> </ul>
Lack of intake air.	Check air intake paths. Check and clean air filter (and intake muffler if installed).
Generator overloaded by too many load.	Reduce the electrical load (switch off load).
Generator overloaded by over-energizing.	Check that the proper capacitor type is installed and that they are connected correctly.
Defective generator (windings, bearings, or other).	Generator must be sent to manufacturer for repair of damaged bearings or winding.
Damaged engine.	Repair of bearing damage, etc., by motor manufacturer-Service.

### 8.9.1.10 Motor runs in off position.

Cause	Solution
Fuel inlet solenoid valve or throttle shut solenoid is not switching off.	Check wire connections to solenoid. Check valve functions as in the „Inlet Fuel Solenoid Valve“ or in the truckle shut off solenoid sections. Replace if necessary.

### 8.9.1.11 Motor stops by itself.

Cause	Solution
Lack of fuel.	Check fuel supply system.
Excess heat in cooling system (thermo switch tripped)-lack of cooling water. Is indicated on the remote control panel.	Check cooling water system flow: water pump, inlet water filter, extra heat exchanger coolant flow.
Lack of oil pressure sensor tripped). Is indicated on the remote control panel.	Check oil-level and if necessary top up. Check motor's oil-pressure and have repaired by motor manufacturer-Service if necessary.
Over-/under voltage. Is indicated on the remote control panel.	Switch-off the remote control panel, reduce the electrical load (switch-off load), start again.

### 8.9.1.12 Sooty black exhaust.

Cause	Solution
Generator is overloaded.	Check electrical load and switch off unnecessary load.
Insufficient intake air.	Check intake air filter; clean if necessary.
Fuel injector faulty.	Replace injector.
Valve clearance incorrect.	Readjust valve clearance to correct value (refer to motor-manual).
Poor fuel quality.	Use better quality diesel (recommended: 2-D Diesel).
Poor combustion.	Incorrect AFR (air/fuel ratio) due to motor timing adjustment. Have motor serviced by manufacturer.
Low compression pressure.	See motor-manual.

### 8.9.1.13 Generator must be shut off immediately if:

Cause	Solution
<ul style="list-style-type: none"> <li>- motor rpm suddenly rises or drops</li> <li>- unusual noise comes from genset</li> <li>- exhaust colour suddenly becomes dark</li> <li>- leakage in the cooling water system.</li> </ul>	Refer to respective section of manual and if necessary, have repaired by motor manufacturer-Service, or Panda representative.

## 9. Appendix

### 9.1 Engine oil

---

#### 9.1.1 Engine oil classification

---

##### 9.1.1.1 Operating range:

The operating range of an engine oil is determined by SAE class. „SAE“ is for the union of American auto engineers (Society of Automotives Engineers).

The SAE class of an engine oil only informs over the viscosity of the oil (larger number = more viscous, smaller number = more highly liquidly) e.g. to 0W, 10W, 15W, 20, 30, 40. The first number shows the liquid of the oil with cold weather, the second number refers to the fluidity with heat. Complete yearly oils have usually SAE classes of SAE 10W-40, SAE 15W-40 etc.

##### 9.1.1.2 Quality of oil:

The quality of an engine oil is specified by the API standard („American Petroleum Institutes“).

The API designation is to be found on each engine oil bundle. The first letter is always a C.

##### API C for diesel engines

The second letter is for the quality of the oil. The more highly the letter in the alphabet, the better the quality.

API C for diesel engine

Examples for diesel engine oil:

API CC Engine oil for small demands

API CD Engine oil for suction- and turbo diesel engine

API CF Replace the specification API CD since 1994

API CG Engine oil for highest demands, turbo-tested

**See technical data for the specificated engine oil**

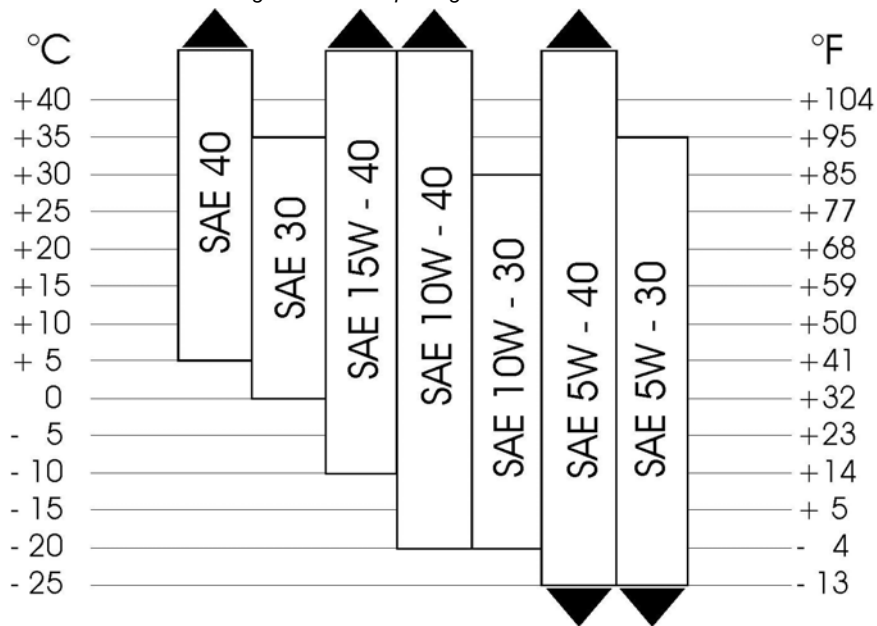
**Notice!:**



Fig. 9.1.1.2-1: Engine oil type.

Engine oil type	
over 25 °C	SAE30 or SAE10W-30; SAE10W-40
0 °C to 25 °C	SAE20 or SAE10W-30; SAE10W-40
below 0 °C	SAE10W or SAE10W-30; SAE10W-40

Fig. 9.1.1-2: Temp. range of the SAE classes



## 9.2 Coolant specifications

Use a mixture of water and antifreeze. The antifreeze needs to be suitable for aluminium. The antifreeze concentration must be regularly checked in the interests of safety.

Fischer Panda recommend to use the product: GLYSANTIN PROTECT PLUS/G 48

Engine coolant automotive industry Product description		
Product name	GLYSANTIN® PROTECT PLUS / G48	
Chemical nature	Monoethylenglycol with inhibitors	
Physical form	Liquid	
Chemical and physical properties		
Reserve alkalinity of 10ml	ASTM D 1121	13 – 15 ml HCl 01 mol/l
Density, 20 °C	DIN 51 757 procedure 4	1,121 – 1,123 g/cm <sup>3</sup>
Water content	DIN 51 777 part 1	max. 3,5 %
pH-value undiluted		7,1 – 7,3

### 9.2.1 Coolant mixture ratio

Water/antifreeze	Temperature
70:30	-20 °C
65:35	-25 °C
60:40	-30 °C
55:45	-35 °C
50:50	-40 °C

## 9.3 Fuel

Use a clean Diesel fuel oil according to DIN590:1999 or better. For Generators with common rail or particle filter use DIN590:2009 or better.

Do not use alternative fuel, because its quality is unknown or it may be inferior in quality. Kerosene, which is very low



in cetane rating, adversely effects the engine.

## 9.4 Technical data coil

Data for generators not mentioned on request.

Notice!:



Fig. 9.4-1: Resistor generator coil HP1

	L-N [Ohm]	L-Z [Ohm]
<b>Mains</b>	<b>120V / 60Hz</b>	
Panda 8000	approx. 0,7	approx. 0,7
Panda 9000	approx. 0,65	approx. 0,65
Panda 12000	approx. 0,45	approx. 0,45
Panda 18	approx. 0,2	approx. 0,2
Panda 24	approx. 0,06	approx. 0,06
<b>Mains:</b>	<b>230V / 50Hz</b>	
Panda 8000	approx. 0,9	approx. 0,9
Panda 9000	approx. 0,8	approx. 0,8
Panda 12000	approx. 0,3	approx. 0,3
Panda 14000	approx. 0,25	approx. 0,25
Panda 18	approx. 0,25	approx. 0,25
Panda 24	approx. 0,17	approx. 0,17
Panda 30	approx. 0,1	approx. 0,1

Fig. 9.4-2: Inductance generator coil HP1

	L-N [Ohm]	L-Z [Ohm]
<b>Mains</b>	<b>120V / 60Hz</b>	
Panda 8000	approx. 2,8	approx. 2,8
Panda 9000	approx. 2,8	approx. 2,8
Panda 12000	approx. 3,5	approx. 3,5
Panda 18	approx. 3,2	approx. 3,2
Panda 24	approx. 0,3	approx. 0,3
<b>Mains</b>	<b>230V / 50Hz</b>	
Panda 8000	approx. 3,7	approx. 3,7
Panda 9000	approx. 3,7	approx. 3,7
Panda 12000	approx. 3,5	approx. 3,5
Panda 14000	approx. 2,3	approx. 2,3
Panda 18	approx. 1,8	approx. 1,8
Panda 24	approx. 1,3	approx. 1,3
Panda 30	approx. 0,9	approx. 0,9

Fig. 9.4-3: Resistor generator coil DVS

	L1-N [Ohm]	L2-N [Ohm]	L3-N [Ohm]	L1'-N [Ohm]	1-2[Ohm]	3-4[Ohm]
<b>Mains</b>	<b>120V / 60Hz</b>					
Panda 8000	approx. 0,7	approx. 0,7	approx. 0,7	approx. 0,15	approx. 0,15	
Panda 9000	approx. 0,65	approx. 0,65	approx. 0,65	approx. 0,17	approx. 0,17	
Panda 12000	approx. 0,45	approx. 0,45	approx. 0,45	approx. 0,15	approx. 0,15	
Panda 18	approx. 0,2	approx. 0,2	approx. 0,2	approx. 0,05	approx. 0,05	
Panda 24	approx. 0,06	approx. 0,06	approx. 0,06			
<b>Mains:</b>	<b>230V / 50Hz</b>					
Panda 8000	approx. 0,9		approx. 0,9		approx. 0,9	approx. 0,4
Panda 9000	approx. 0,8		approx. 0,8		approx. 0,8	approx. 0,4
Panda 12000	approx. 0,3		approx. 0,3		approx. 0,3	approx. 0,2
Panda 14000	approx. 0,25	approx. 0,25	approx. 0,25	approx. 0,12		
Panda 18	approx. 0,25	approx. 0,25	approx. 0,25	approx. 0,1		
Panda 24	approx. 0,17	approx. 0,17	approx. 0,17	approx. 0,1		
Panda 30	approx. 0,1	approx. 0,1	approx. 0,1	approx. 0,08		

Fig. 9.4-4: Inductance generator coil DVS

	L1-N [mH]	L2-N [mH]	L3-N [mH]	L1'-N [mH]	1-2[mH]	3-4[mH]
<b>Mains</b>	<b>120V / 60Hz</b>					
Panda 8000	approx. 2,8	approx. 2,8	approx. 2,8	approx. 0,8	approx. 0,8	
Panda 9000	approx. 2,8	approx. 2,8	approx. 2,8		approx. 0,9	approx. 0,9
Panda 12000	approx. 3,5	approx. 3,5	approx. 3,5	approx 1,0	approx. 1,0	
Panda 18	approx. 3,2	approx. 3,2	approx. 3,2		approx. 0,4	approx. 0,4
Panda 24	approx. 0,3	approx. 0,3	approx. 0,3			
<b>Mains:</b>	<b>230V / 50Hz</b>					

	L1-N [mH]	L2-N [mH]	L3-N [mH]	L1'-N [mH]	1-2[mH]	3-4[mH]
Panda 8000	approx. 3,7	approx. 3,7	approx. 3,7	approx. 2,3		
Panda 9000	approx. 3,7	approx. 3,7	approx. 3,7	approx. 2,3		
Panda 12000	approx. 3,5	approx. 3,5	approx. 3,5	approx. 2,3		
Panda 14000	approx. 2,3	approx. 2,3	approx. 2,3	approx. 1,5		
Panda 18	approx. 1,8	approx. 1,8	approx. 1,8	approx. 1,1		
Panda 24	approx. 1,3	approx. 1,3	approx. 1,3	approx. 0,8		
Panda 30	approx. 0,9	approx. 0,9	approx. 0,9	approx. 0,6		

*Fig. 9.4-5: Voltage values stator coil*

Terminal	Panda 8000	Panda 9000	Panda 12000	Panda 14000	Panda 18	Panda 24	Panda 30
L1 - L2	3-5 Volt	4-6 Volt	5-7 Volt	6-9 Volt	6-10 Volt	6-11 Volt	7-12 Volt
L2 - L3	3-5 Volt	4-6 Volt	5-7 Volt	6-9 Volt	6-10 Volt	6-11 Volt	7-12 Volt
L3 - L1	3-5 Volt	4-6 Volt	5-7 Volt	6-9 Volt	6-10 Volt	6-11 Volt	7-12 Volt
L1' - N (50Hz)	~ 2-3 Volt	~ 2-3 Volt	~ 3-4 Volt	~ 3-5 Volt	~ 3-5 Volt	~ 3-5 Volt	~ 3-6 Volt
4 - 2 (60Hz)	~ 2-3 Volt	~ 2-3 Volt	~ 3-4 Volt		~ 3-5 Volt	~ 3-5 Volt	

*Fig. 9.4-6: Voltage values stator coil*

Terminal	Panda 8000	Panda 9000	Panda 12000	Panda 14000	Panda 18	Panda 24	Panda 30
L - N	~ 2-3 Volt	~ 2-3 Volt	~ 3-4 Volt	~ 3-5 Volt	~ 3-5 Volt	~ 3-5 Volt	~ 3-6 Volt
4 - 2 (60Hz)	~ 2-3 Volt	~ 2-3 Volt	~ 3-4 Volt		~ 3-5 Volt	~ 3-5 Volt	

## 9.5 Diameter of conduits vehicle generators

*Fig. 9.5-1: Diameter of conduits*

Generatortyp Generator type	Kühlwasser Cooling water	Abgas Exhaust	Kraftstoff Fuel	
			Zulauf Feed	Rücklauf Return
Panda PVMV-N 4000i/5000i	20	40	8	8
Panda PVMV-N 4,5 ND	20	40	8	8
Panda PVMV-N 5000 LPE	20	40	8	8
Panda PVMV-N 6000 ND	25	40	8	8
Panda PVMV-N 6000i/8000i	20	40	8	8
Panda PVMV-N 8000 NE	25	40	8	8
Panda PVMV-N 9000 ND	25	40	8	8
Panda PVMV-N 12000NE	25	40	8	8
Panda PVMV-N 14000 NE	25	40	8	8
Panda PVMV-N 15000 NE / 15000i	25	40	8	8
Panda PVMV-N 18 NE	25	40	8	8
Panda PVMV-N 24 NE	25	40	8	8
Panda PVMV-N 30 NE	25	40	8	8
Panda PVMV-N 35 YA	30	50	8	8
Panda PVMV-N 22/4	30	50	8	8
Panda PVMV-N 47 YA	30	60	8	8
Panda PVMV-N 60 MB				
Panda PVMV-N 75MB				
Panda PVMV-N 100 MB				
Panda PVM-NE 4000i/5000i	20	40	8	8
Panda PVM-NE 4,5 ND	20	40	8	8
Panda PVM-NE 5000 LPE	20	40	8	8

Generatortyp Generator type	Kühlwasser Cooling water	Abgas Exhaust	Kraftstoff Fuel	
			Zulauf Feed	Rücklauf Return
Panda PVM-NE 6000 ND	25	40	8	8
Panda PVM-NE 6000i/8000i	20	40	8	8
Panda PVM-NE 8000 NE	25	40	8	8
Panda PVM-NE 9000 ND	25	40	8	8
Panda PVM-NE 12000 NE	25	40	8	8
Panda PVM-NE 14000 NE	25	40	8	8
Panda PVM-NE 15000 NE / 15000i	25	40	8	8
Panda PVM-NE 18 NE	25	40	8	8
Panda PVM-NE 24 NE	25	40	8	8
Panda PVM-NE 30 NE	25	40	8	8
Panda PVM-NE 35 YA	30	50	8	8
Panda PVM-NE 47 YA	30	60	8	8
Panda PVM-NE 40 LN	30	60	8	8
Panda PVM-NE 60 MB	40	76	8	8
Panda PVM-NE 75 MB	40	76	8	8
Panda PVM-NE 100 MB	50	76	8	8
Panda PVM-NE 110 DZ	50	76	8	8
Panda PVMH 8000 NE	25	40	8	8
Panda PVMH 12000 NE	25	40	8	8
Panda PVMH 14000 NE	25	40	8	8

Fig. 9.5-2: Diameter of conduits

Generatortyp Generator type	Kühlwasser Cooling water	Abgas Exhaust	Kraftstoff Fuel	
			Zulauf Feed	Rücklauf Return
Panda PVK-U 4000i/5000i	20	40	8	8
Panda PVK-U 4,5 ND	20	40	8	8
Panda PVK-U 5000 LPE	20	40	8	8
Panda PVK-U 6000 ND	25	40	8	8
Panda PVK-U 6000i/8000i	20	40	8	8
Panda PVK-U 8000 NE	25	40	8	8
Panda PVK-U 9000 ND	25	40	8	8
Panda PVK-U 12000 NE	25	40	8	8
Panda PVK-U 14000 NE	25	40	8	8
Panda PVK-U 15000 NE / 15000i	25	40	8	8
Panda PVK-U 18 NE	25	40	8	8
Panda PVK-U 24 NE	25	40	8	8
Panda PVK-U 30 NE	25	40	8	8
Panda PVK-U 35 YA	30	50	8	8
Panda PVK-U 47 YA	30	60	8	8
Panda PVK-U 60 MB	40	76	8	8
Panda PVK-U 75 MB	40	76	8	8
Panda PVK-U 100 MB	50	76	8	8
Panda PVK-UK 4000i/5000i	20	40	8	8
Panda PVK-UK 4,5 ND	20	40	8	8



Generatortyp Generator type	Kühlwasser Cooling water	Abgas Exhaust	Kraftstoff Fuel	
			Zulauf Feed	Rücklauf Return
Panda PVK-UK 5000 LPE	20	40	8	8
Panda PVK-UK 6000 ND	20	40	8	8
Panda PVK-UK 6000i/8000i	20	40	8	8
Panda PVK-UK 8000 NE	25	40	8	8
Panda PVK-UK 9000 ND	25	40	8	8
Panda PVK-UK 12000 NE	25	40	8	8
Panda PVK-UK 14000 NE	25	40	8	8
Panda PVK-UK 15000 NE / 15000i	25	40	8	8
Panda PVK-UK 9-4	25	40	8	8
Panda PVK-UK 18 NE	25	40	8	8
Panda PVK-UK 24 NE	25	40	8	8
Panda PVK-UK 30 NE	25	40	8	8
Panda PVK-UK 35 YA	30	50	8	8
Panda PVK-UK 47 YA	30	60	8	8
Panda PVK-UK 60 MB	40	76	8	8
Panda PVK-UK 75 MB	40	76	8	8
Panda PVK-UK 100 MB	50	76	8	8

## 9.6 Rated current

Data for generators not mentioned on request.

Notice!:



Fig. 9.6-1: Rated current

Generator	Current	Generator	Current
Panda 8000 - 230 V / 50 Hz	27,0 A	Panda 18 - 230 V / 50 Hz	60,3 A
Panda 8000 - 400 V / 50 Hz	8,3 A	Panda 18 - 400 V / 50 Hz	20,0 A
Panda 8000 - 120 V / 60 Hz	61,8 A	Panda 18 - 120 V / 60 Hz	128,0 A
Panda 9000 - 230 V / 50 Hz	34,9 A	Panda 24 - 230 V / 50 Hz	89,1 A
Panda 9000 - 400 V / 50 Hz	11,1 A	Panda 24 - 400 V / 50 Hz	30,1 A
Panda 9000 - 120 V / 60 Hz	74,5 A	Panda 24 - 120 V / 60 Hz	161,1 A
Panda 12000 - 230 V / 50 Hz	41,7 A	Panda 30 - 230 V / 50 Hz	Request
Panda 12000 - 400 V / 50 Hz	13,7 A	Panda 30 - 400 V / 50 Hz	35 A
Panda 12000 - 120 V / 60 Hz	89,0 A	Panda 30 - 120 V / 60 Hz	219 A
Panda 14000 - 230 V / 50 Hz	48,0 A	Panda 40 - 230 V/400 V / 50 Hz (3~ N PE)	52 A
Panda 14000 - 400 V / 50 Hz	15,2 A	Panda 47 - 230 V/400 V / 50 Hz (3~ N PE)	52 A
Panda 14000 - 120 V / 60 Hz	112,7 A		

## 9.7 Cable cross-section

Fig. 9.7-1: Cable cross-section

Voltage	Required cable cross-section						
	< 6 kW	6-10 kW	10-15 kW	15-20 kW	20-35 kW	35-45 kW	45-65 kW
120V 1-ph.+PEN	4x6mm <sup>2</sup>	4x10mm <sup>2</sup>	4x16mm <sup>2</sup>	4x25mm <sup>2</sup>	4x35mm <sup>2</sup>	4x50mm <sup>2</sup>	4x70mm <sup>2</sup>
230V 1-ph.+PEN	2x4mm <sup>2</sup>	2x6mm <sup>2</sup>	2x10mm <sup>2</sup>	2x16mm <sup>2</sup>	2x25mm <sup>2</sup>	2x35mm <sup>2</sup>	2x35mm <sup>2</sup>
400V 3-ph.+PEN	4x2,5mm <sup>2</sup>	4x4mm <sup>2</sup>	4x6mm <sup>2</sup>	4x10mm <sup>2</sup>	4x16mm <sup>2</sup>	4x16mm <sup>2</sup>	4x25mm <sup>2</sup>

## 9.8 Technical data

Fig. 9.8-1: Technical data

	Panda 4000s Panda 4,5ND	Panda 4200 FCB	4500FCB	Panda 4k Panda 5k	Panda 5000 LPE
Type	Farymann 18W430	Farymann 18W430	Farymann 18W430	Z482	EA300
Governor	mechanic	mechanic	mechanic	mechanic VCS	VCS
Automatic start booster	yes	yes	yes	no	no
Cylinder	1	1	1	2	1
Bore	82 mm	82 mm	82 mm	67 mm	75 mm
Stroke	55 mm	55 mm	55 mm	68 mm	70 mm
Stroke volume	290 cm <sup>3</sup>	290 cm <sup>3</sup>	290 cm <sup>3</sup>	479 cm <sup>3</sup>	309 cm <sup>3</sup>
Max. power (DIN 6271-NB) at 3000 rpm	5,7 kW	5,7 kW	5,7 kW	9,32 kW	5,1 kW
Rated speed	3600 rpm	3600 rpm	3600 rpm	3000 rpm	3000 rpm
Idle running speed <sup>2</sup>	3690 rpm	3690 rpm	3690 rpm	3120 rpm	2900 rpm



	Panda 4000s Panda 4,5ND	Panda 4200 FCB	4500FCB	Panda 4k Panda 5k	Panda 5000 LPE
Valve clearance (engine cold)	0,2 mm	0,2 mm	0,2 mm	0,2 mm	0,16 - 0,20 mm
Cylinder head nut torque	30-33 Nm	30-33 Nm	30-33 Nm	42 Nm	58,8 - 63,7 Nm
Compression ratio	20:1	20:1	20:1	23:1	--
Lubrication oil capacity	1,25 l	1,25 l	1,25 l	2,8 l	1,3 l
Fuel consumption <sup>3</sup>	approx 0,42- 1,12 l	approx. 0,42- 1,12 l	approx. 0,42- 1,12 l	approx. 0,5-1,4 l	approx. 0,42 - 1,12 l
Oil consumption	max. 1 % of fuel consumption				
Oil specification	API CF	API CF	API CF	API CF	API CF
Cooling water requirement for seawater circuit (Marine generators only)	10-12 l/min	10-12 l/min	16-28 l/min	16-28 l/min	--
Permissible max. permanent tilt of engine	a) 25° across the longitudinal axis b) 20° in the longitudinal direction				
Recommend starter battery size	12 V 28 Ah equivalent	12 V 28 Ah equivalent	12 V 36 Ah equivalent	12 V 28 Ah equivalent	12 V 28 Ah equivalent
Recommend cable cross size starter battery cable <i>Length 4 meter max.</i>	25 mm <sup>2</sup>	25 mm <sup>2</sup>	25 mm <sup>2</sup>	25 mm <sup>2</sup>	25 mm <sup>2</sup>
Max. exhaust back pressure	9,3 kPa 93 Millibar	9,3 kPa 93 Millibar <sup>2</sup>	9,3 kPa 93 Millibar	9,3 kPa 93 Millibar	--

<sup>2</sup> progressive speed by VCS

<sup>3</sup> 0,35 l/kWh electrical power, the randomized values between 30 % and 80 % of the rated speed

Fig. 9.8-2: Technical data

	Panda 6500 Panda 7 mini	Panda 8000 Panda 8 mini	Panda 9000	Panda 10000 Panda 9 mini	Panda 12000
Type	Z482	Z482	D722	Z602	D722
Governor	Mlni VCS	VCS	mechanic	VCS	VCS
Automatic start booster	no	yes	no	yes	yes
Cylinder	2	2	3	2	3
Bore	67 mm	67 mm	67 mm	72 mm	67 mm
Stroke	68 mm	68 mm	68 mm	73,6 mm	68 mm
Stroke volume	479 cm <sup>3</sup>	479 cm <sup>3</sup>	719 cm <sup>3</sup>	599 cm <sup>3</sup>	719 cm <sup>3</sup>
Max. power (DIN 6271-NB) at 3000 rpm	9,32 kW	9,32 kW	14,0 kW	11,6 kW	14,0 kW
Rated speed	3000 rpm	3000 rpm	3000 rpm	3000 rpm	3000 rpm
Idle running speed <sup>2</sup>	3120 rpm	2900 rpm	3120 rpm	3100 rpm	2900 rpm
Valve clearance (engine cold)	0,2 mm	0,2 mm	0,2 mm	0,2 mm	0,2 mm
Cylinder head nut torque	42 Nm	42 Nm	42 Nm	42 Nm	42 Nm
Compression ratio	23:1	23:1	23:1	24:1	23:1
Lubrication oil capacity	2,8 l	2,8 l	3,8 l	2,8 l	3,8 l
Fuel consumption <sup>3</sup>	approx. 0,5-1,4 l	approx. 0,7-1,8 l	approx. 0,8-2,1 l	approx. 1,0-2,66 l	approx. 1,1-2,8 l
Oil consumption	max. 1 % of fuel consumption				
Oil specification	API CF	API CF	API CF	API CF	API CF
Cooling water requirement for seawater circuit (Marine generators only)	16-28 l/min	16-28 l/min	16-28 l/min	16-28 l/min	16-28 l/min
Permissible max. permanent tilt of engine	a) 25° across the longitudinal axis b) 20° in the longitudinal direction				
Recommend starter battery size	12 V 28 Ah equivalent	12 V 28 Ah equivalent	12 V 36 Ah equivalent	12 V 36 Ah equivalent	12 V 36 Ah equivalent
Recommend cable cross size starter battery cable <i>Length 4 meter max.</i>	25 mm <sup>2</sup>	25 mm <sup>2</sup>	25 mm <sup>2</sup>	25 mm <sup>2</sup>	25 mm <sup>2</sup>

	Panda 6500 Panda 7 mini	Panda 8000 Panda 8 mini	Panda 9000	Panda 10000 Panda 9 mini	Panda 12000
<b>Max. exhaust back pressure</b>	9,3 kPa 93 Millibar	9,3 kPa 93 Millibar <sup>2</sup>	9,3 kPa 93 Millibar	9,3 kPa 93 Millibar	9,3 kPa 93 Millibar

<sup>2</sup> progressive speed by VCS

<sup>3</sup> 0,35 l/kW electrical power, the randomized values between 30 % and 80 % of the rated speed

Fig. 9.8-3: Technical data

	Panda 12000	Panda 15000 15 mini digital	Panda 18	Panda 24	Panda 30
<b>Type</b>	Mitsubishi MVL3E	D902	D1105	V1505	V1505 TD
<b>Governor</b>	xContol Servo	VCS	VCS	VCS	VCS
<b>Automatic start booster</b>	yes	yes	yes	no	no
<b>Cylinder</b>	3	3	3	4	4TD
<b>Bore</b>	76 mm	72 mm	78 mm	78 mm	78 mm
<b>Stroke</b>	70 mm	73,6 mm	78,4 mm	78,4 mm	78,4 mm
<b>Stroke volume</b>	952 cm <sup>3</sup>	898 cm <sup>3</sup>	1123 cm <sup>3</sup>	1498 cm <sup>3</sup>	1498 cm <sup>3</sup>
<b>Max. power (DIN 6271-NB) at 3000 rpm</b>		17,5 kW	18,7 kW	23,3 kW	31,3 kW
<b>Rated speed</b>		3000 rpm	3000 rpm	3000 rpm	3000 rpm
<b>Idle running speed <sup>2</sup></b>		2900 rpm	2900 rpm	2900 rpm	2900 rpm
<b>Valve clearance (engine cold)</b>		0,2 mm	0,2 mm	0,2 mm	0,2 mm
<b>Cylinder head nut torque</b>		42 mm	68 Nm	68 Nm	68 Nm
<b>Compression ratio</b>	23:1	24:1	22:1	22:1	23:1
<b>Lubrication oil capacity</b>	3,6 l	3,7 l	5,1 l	6,0 l	6,7 l
<b>Fuel consumption <sup>3</sup></b>	approx. 1,1-2,8 l	approx. 1,3-3,6 l	approx. 1,7-4,5 l	approx. 2,2-5,9 l	approx. 2,7-7,2 l
<b>Oil consumption</b>	max. 1 % of fuel consumption				
<b>Oil specification</b>	API CF-4	API CF	API CF	API CF	API CF
<b>Cooling water requirement for seawater circuit (Marine generators only)</b>	16-28 l/min	16-28 l/min	28-40 l/min	28-40 l/min	40-50 l/min
<b>Permissible max. permanent tilt of engine</b>	a) 25° crosswise to the longitudinal axis b) 20° in longitudinal direction				
<b>Recommend starter battery size</b>	12 V 36 Ah equivalent	12 V 52 Ah equivalent	12 V 65 Ah equivalent	12 V 70 Ah equivalent	12 V 70 Ah equivalent
<b>Recommend cable cross size starter battery cable</b> <i>Length 4 meter max.</i>	25 mm <sup>2</sup>	25 mm <sup>2</sup>	25 mm <sup>2</sup>	25 mm <sup>2</sup>	25 mm <sup>2</sup>
<b>Max. exhaust back pressure</b>		9,3 kPa 93 Millibar <sup>2</sup>	10,7 kPa 107 Millibar	10,7 kPa 107 Millibar	10,7 kPa 107 Millibar

<sup>2</sup> progressive speed by VCS

<sup>3</sup> 0,35 l/kW electrical power, the randomized values between 30 % and 80 % of the rated speed

Fig. 9.8-4: Technical data

	Panda 30 IC	Panda 40 LN	Panda 47 LN	Panda 60 MB	Panda 75 MB
<b>Type</b>	Kubota V 1505 TB	LDW 2204 MT	LDW 2204T	Mercedes Benz OM602	Mercedes OM603A
<b>Governor</b>	VCS	VCS	VCS	mechanic + VCS	mechanic + VCS
<b>Automatic start booster</b>	yes	no	no	no	no
<b>Cylinder</b>	4	4	4	5	6
<b>Bore</b>	78 mm	88 mm	88 mm	89 mm	89 mm
<b>Stroke</b>	78,4 mm	90,4 mm	90,4 mm	92,4 mm	92,4 mm
<b>Stroke volume</b>	1498 cm <sup>3</sup>	2199 cm <sup>3</sup>	2199 cm <sup>3</sup>	2874 cm <sup>3</sup>	3500 cm <sup>3</sup>
<b>Max. power (DIN 6271-NB) at 3000 rpm</b>	31,3 kW	36 kW	36 kW	69 kW	69 kW
<b>Rated speed</b>	3000 rpm	3000 rpm	3000 rpm	4000 rpm	3000 rpm



	Panda 30 IC	Panda 40 LN	Panda 47 LN	Panda 60 MB	Panda 75 MB
Idle running speed <sup>2</sup>	2900 rpm	3000 rpm	3000 rpm		2900 rpm
Valve clearance (engine cold)	0,2 mm	Hydro	Hydro		0,2 mm
Cylinder head nut torque	63,7 - 68,6 Nm	68 Nm	68 Nm		25 Nm
Compression ratio	22,5:1	22:16	22:16		22:1
Lubrication oil capacity	6,0 l	6,4 l	6,4 l	7,5 l	7,5 l
Fuel consumption <sup>3</sup>	approx. 2,7 - 7,1 l	approx. 4,9-13,1 l	approx. 3,78-10,1 l	approx. 6,3 - 16,8 l	approx. 6,7 - 17,9 l
Oil consumption	max. 1 % of fuel consumption			max. 0,5 % of fuel consumption	
Oil specification	API CF	API CF	API CF-4	API CF	API CF
Cooling water requirement for seawater circuit (Marine generators only)	40-50 l/min	40-50 l/min	40-50 l/min		
Permissible max. permanent tilt of engine	a) 25° crosswise to the longitudinal axis b) 20° in longitudinal direction				
Recommend starter battery size	12 V 70 Ah equivalent	12 V 88 Ah equivalent	12 V 88 Ah equivalent	12 V 95 Ah equivalent	12 V 95 Ah equivalent
Recommend cable cross size starter battery cable <i>Length 4 meter max.</i>	25 mm <sup>2</sup>	50 mm <sup>2</sup>	50 mm <sup>2</sup>	70 mm <sup>2</sup>	70 mm <sup>2</sup>
Max. exhaust back pressure	10,7 kPa 107 Millibar	10 kPa 100 Millibar	10 kPa 100 Millibar		

<sup>2</sup> progressive speed by VCS

<sup>3</sup> 0,35 l/kW electrical power, the randomized values between 30 % and 80 % of the rated speed

Fig. 9.8-5: Technical data

	Panda 7,5-4	Panda 9-4	Panda 12-4	Panda 17-4	Panda 22-4
Type	Kubota D905	Kubota D1105	Kubota V1505	Kubota V2203	Kubota V2403
Governor	mechanic + VCS	VCS	VCS	VCS	VCS
Automatic start booster	no	no	no	no	no
Cylinder	3	3	4	4	4
Bore	72 mm	78 mm	78 mm	87 mm	87 mm
Stroke	73,6 mm	78,4 mm	78,4 mm	92,4 mm	102,4 mm
Stroke volume	898 cm <sup>3</sup>	1123 cm <sup>3</sup>	1498 cm <sup>3</sup>	2197 cm <sup>3</sup>	2434 cm <sup>3</sup>
Max. power (DIN 6271-NB) at 3000 rpm	17,5 kW	18,7 kW	23,3 kW	20,1 kW	31,1 kW
Rated speed	1500 rpm	1500 rpm	1500 rpm	1500 rpm	1500 rpm
Idle running speed <sup>2</sup>	1500 rpm	1500 rpm	1800 rpm	1500 rpm	1800 rpm
Valve clearance (engine cold)	0,145 - 0,185 mm	0,145 - 0,185 mm	0,2 mm	0,2 mm	0,18 - 0,22 mm
Cylinder head nut torque	63,7 - 68,6 Nm	63,7 - 68,6 Nm	68 Nm	68 Nm	93,1 - 98 Nm
Compression ratio	23:1	23:1	22:1	22:1	
Lubrication oil capacity	5,1 l	5,1 l	6,0 l	9,5 l	9,5 l
Fuel consumption <sup>3</sup>	0,7 - 1,8 l	0,84 - 2,24 l	ca. 1,20-3,36 l	ca. 1,8-4,9 l	approx. 1,95 - 5,2 l
Oil consumption	max. 1 % of fuel consumption				
Oil specification	API CF	API CF	API CF	API CF	API CF
Cooling water requirement for seawater circuit (Marine generators only)	6-28 l/min	28-40 l/min	28-40 l/min	28-40 l/min	40-50 l/min
Permissible max. permanent tilt of engine	a) 25° crosswise to the longitudinal axis b) 20° in longitudinal direction				
Recommend starter battery size	12 V 65 Ah equivalent	12 V 65 Ah equivalent	12 V 70 Ah equivalent	12 V 120 Ah equivalent	12 V 136 Ah equivalent
Recommend cable cross size starter battery cable <i>Length 4 meter max.</i>	25 mm <sup>2</sup>	25 mm <sup>2</sup>	25 mm <sup>2</sup>	70 mm <sup>2</sup>	70 mm <sup>2</sup>



	Panda 7,5-4	Panda 9-4	Panda 12-4	Panda 17-4	Panda 22-4
<b>Max. exhaust back pressure</b>	10,7 kPa 107 Millibar	10,7 kPa 107 Millibar	10,7 kPa 107 Millibar	10,7 kPa 107 Millibar	10,7 kPa 107 Millibar

<sup>2</sup> progressive speed by VCS

<sup>3</sup> 0,35 l/kW electrical power, the randomized values between 30 % and 80 % of the rated speed

Fig. 9.8-6: Technical data

	Panda 30/4	Panda 30/4	Panda 40/4	Panda 50/4	Panda 70/4
<b>Type</b>	Mitsubishi S-DTS	V3600	V3600	V3800 DI-T	BF4M 1013EC
<b>Governor</b>	VCS	VCS	VCS	mechanic + GAC	VCS
<b>Automatic start booster</b>	no	no	no	no	no
<b>Cylinder</b>	4	4	4	4	4
<b>Bore</b>	94 mm	98 mm	98 mm	100 mm	108 mm
<b>Stroke</b>	120 mm	120 mm	120 mm	120 mm	130 mm
<b>Stroke volume</b>	3331 cm <sup>3</sup>	3620 cm <sup>3</sup>	3620 cm <sup>3</sup>	3769 cm <sup>3</sup>	4764 cm <sup>3</sup>
<b>Max. power (DIN 6271-NB) at 3000 rpm</b>		45,8 kW	58,8 kW	62,0 kW	85,0 kW
<b>Rated speed</b>	1500 rpm	1500 rpm	1500 rpm	1500 rpm	1500 rpm
<b>Idle running speed <sup>2</sup></b>	1500 rpm	1800 rpm	2800 rpm	1800 rpm	1800 rpm
<b>Valve clearance (engine cold)</b>	0,25 mm	0,2 mm	0,2 mm	0,2 mm	inlet 0,3 <sup>+0,1</sup> mm / outlet 0,5 <sup>+0,1</sup> mm
<b>Cylinder head nut torque</b>	118 Nm	68 Nm	68 Nm	68 Nm	
<b>Compression ratio</b>	20,5:1	22,6:1	22,6:1	19,0:1	17,6:1
<b>Lubrication oil capacity</b>	10,0 l	13,2 l	13,2 l	13,2 l	14,0 l
<b>Fuel consumption <sup>3</sup></b>	approx. 3,15-8,4 l	approx. 3,15-8,4 l	approx. 3,78-10,1 l	approx. 4,2-11,2 l	approx. 6,5-17,3 l
<b>Oil consumption</b>	max. 1 % of fuel consumption				
<b>Oil specification</b>	API CF4 (SAE30)	API CF	API CF	API CF	API CF
<b>Cooling water requirement for seawater circuit (Marine generators only)</b>	40-50 l/min	40-50 l/min	40-50 l/min	40-50 l/min	
<b>Permissible max. permanent tilt of engine</b>	a) 25° crosswise to the longitudinal axis b) 20° in longitudinal direction				
<b>Recommend starter battery size</b>	12 V 136 Ah equivalent	12 V 136 Ah equivalent	12 V 136 Ah equivalent	12 V 136 Ah equivalent	
<b>Recommend cable cross size starter battery cable</b> <i>Length 4 meter max.</i>	70 mm <sup>2</sup>	70 mm <sup>2</sup>	70 mm <sup>2</sup>	70 mm <sup>2</sup>	
<b>Max. exhaust back pressure</b>	4 kPa 40 Millibar	10,7 kPa 107 Millibar	10,7 kPa 107 Millibar	10,7 kPa 107 Millibar	

<sup>2</sup> progressive speed by VCS

<sup>3</sup> 0,35 l/kW electrical power, the randomized values between 30 % and 80 % of the rated speed

Fig. 9.8-7: Technical data igenerators

	Panda 5000i	Panda 8000i	Panda 10000i	Panda 15000i	Panda 25i
<b>Type</b>	EA300	Z482	Z602	D902	Kubota V1505
<b>Governor</b>	iControl2	iControl2	iControl2	iControl2	iControl2
<b>Automatic start booster</b>	no	no	no	no	no
<b>Cylinder</b>	1	2	2	3	4
<b>Bore</b>	75 mm	67 mm	72 mm	72 mm	78 mm
<b>Stroke</b>	70 mm	68 mm	73,6 mm	73,6 mm	78,4 mm
<b>Stroke volume</b>	309 cm <sup>3</sup>	479 cm <sup>3</sup>	599 cm <sup>3</sup>	898 cm <sup>3</sup>	1498 cm <sup>3</sup>
<b>Max. power (DIN 6271-NB) at 3000 rpm</b>	5,1 kW	9,32 kW	11,6 kW	17,5 kW	23,3 kW
<b>Rated speed</b>	3000 rpm	3000 rpm	3000 rpm	3000 rpm	1500 rpm



	Panda 5000i	Panda 8000i	Panda 10000i	Panda 15000i	Panda 25i
Idle running speed	2900 rpm	2900 rpm	3100 rpm	2900 rpm	1800 rpm
Valve clearance (engine cold)	0,16 - 0,20 mm	0,2 mm	0,2 mm	0,2 mm	0,2 mm
Cylinder head nut torque	58,8 - 63,7 Nm	42 Nm	42 Nm	42 mm	68 Nm
Compression ratio	--	23:1	24:1	24:1	22:1
Lubrication oil capacity	1,3 l	2,8 l	2,8 l	3,7 l	6,0 l
Fuel consumption <sup>3</sup>	approx. 0,42 - 1,12 l	approx. 0,7-1,8 l	approx. 1,0-2,66 l	approx. 1,3-3,6 l	approx. 1,20-3,36 l
Oil consumption	max. 1 % of fuel consumption				
Oil specification	API CF	API CF	API CF	API CF	API CF
Cooling water requirement for seawater circuit (Marine generators only)	--	16-28 l/min	16-28 l/min	16-28 l/min	28-40 l/min
Permissible max. permanent tilt of engine	a) 25° crosswise to the longitudinal axis b) 20° in longitudinal direction				
Recommend starter battery size	12 V 28 Ah equivalent	12 V 28 Ah equivalent	12 V 36 Ah equivalent	12 V 52 Ah equivalent	12 V 70 Ah equivalent
Recommend cable cross size starter battery cable <i>Length 4 meter max.</i>	25 mm <sup>2</sup>	25 mm <sup>2</sup>	25 mm <sup>2</sup>	25 mm <sup>2</sup>	25 mm <sup>2</sup>
Max. exhaust back pressure	--	9,3 kPa 93 Millibar <sup>2</sup>	9,3 kPa 93 Millibar	9,3 kPa 93 Millibar	10,7 kPa 107 Millibar

<sup>3</sup> 0,35 l/kW electrical power, the randomized values between 30 % and 80 % of the rated speed

Fig. 9.8-8: Technical data igenerators

	Panda 45i				
Type	Kubota V2403				
Governor	iControl2				
Automatic start booster	no				
Cylinder	4				
Bore	87 mm				
Stroke	102,4 mm				
Stroke volume	2434 cm <sup>3</sup>				
Max. power (DIN 6271-NB) at 3000 rpm	31,1 kW				
Rated speed	2700 rpm				
Idle running speed	1600 rpm				
Valve clearance (engine cold)	0,18 - 0,22 mm				
Cylinder head nut torque	93,1 - 98 Nm				
Compression ratio					
Lubrication oil capacity	9,5 l				
Fuel consumption <sup>3</sup>	approx. 1,95 - 5,2 l				
Oil consumption	max. 1 % of fuel consumption				
Oil specification	API CF				
Cooling water requirement for seawater circuit (Marine generators only)	55-80 l/min				
Permissible max. permanent tilt of engine	a) 25° crosswise to the longitudinal axis b) 20° in longitudinal direction				
Recommend starter battery size	12 V 136 Ah equivalent				
Recommend cable cross size starter battery cable <i>Length 4 meter max.</i>	70 mm <sup>2</sup>				
Max. exhaust back pressure	10,7 kPa 107 Millibar				

<sup>3</sup> 0,35 l/kW electrical power, the randomized values between 30 % and 80 % of the rated speed

Leere Seite / Intentionally blank



# Fischer Panda®

Power  
wherever  
you are™



## Panda xControl Manual

## Current revision status

	Document
Actual:	Panda_xControl_eng.R01.5_10.6.16
Replace:	Panda_xControl_eng.R01.4

Revision	Page
R01.1 Funktion überarbeitet	
R01.2 Sybole eingearbeitet	
R01.3 Symbole von Anhang hinter Fehlertabelle geschoben	
R01.4 Fehlercodes erweitert	
R01.5 Fehlercodes erweitert	

### Erstellt durch / created by

Fischer Panda GmbH - Leiter Technische Dokumentation

Otto-Hahn-Str. 32-34

33104 Paderborn - Germany

Tel.: +49 (0) 5254-9202-0

email: [info@fischerpanda.de](mailto:info@fischerpanda.de)

web: [www.fischerpanda.de](http://www.fischerpanda.de)

### Copyright

#### Duplication and change of the manual is permitted only in consultation with the manufacturer!

Fischer Panda GmbH, 33104 Paderborn, reserves all rights regarding text and graphics. Details are given to the best of our knowledge. No liability is accepted for correctness. Technical modifications for improving the product without previous notice may be undertaken without notice. Before installation, it must be ensured that the pictures, diagrams and related material are applicable to the genset supplied. Enquiries must be made in case of doubt.



**Fischer Panda GmbH**  
 Otto-Hahn-Str. 40  
 D-33104 Paderborn  
 Germany

Tel. : +49 (0)5254 9202-0  
 Fax. : +49 (0)5254 9202-  
 Hotline : 550  
 Email : +49 (0)5254 9202-  
 Web : 767

[info@fischerpanda.de](mailto:info@fischerpanda.de)

[www.fischerpanda.de](http://www.fischerpanda.de)



## 10. Safety Instructions Panda xControl

### 10.1 Personal requirements

---

The settings described here can be performed by the operator, unless otherwise indicated.

The installation should be carried out by specially trained personnel or by authorized repair shops (Fischer Panda service points).

### 10.2 Safety instructions

---

**Follow the general safety instruction at the front of this manual.** **Note!**

If these not exist, they can be requested at Fischer Panda GmbH, 33104 Paderborn.



**Danger for life! - The generator can be equipped with an automatic start device. This means expected starting of the generator, the starter battery must be disconnected before start working at the generator.**

**Warning! Automatic start**



**The generator must not be put into operation with cover removed.**

**Warning!**



If the generator is mounted without sound cover, the rotating parts (pulley, belt, etc.) must be covered and protected so that an injury is excluded.

All service, maintenance or repair work on the unit may be made only while the motor is off.

**Danger for Life. Improper handling, operation, installation and maintenance can result in severe personal injury and/or material damage.**

**Warning! Danger of Life - High voltage**



Electrical voltages above 60 volts DC and 25V AC are always dangerous to life). The rules of the respective regional authority must be adhered to. Only an electrician may carry out installation of the electrical connections for safety reasons.

**Disconnect the battery when working on the generator.** **Attention!**

The battery must always be disconnected (first negative then positive pole), when work on the generator or the electrical system of the generator are made, so that the generator can not be started accidentally.



This is especially true for systems with an automatic start function. The automatic start function is to be deactivated before the work.

*Sea valve must be closed. (only PMS version)*

Note also the safety of the other components of your system.

Note!





## 11. Panda xControl

The Panda xControl is a generator control system with three main components.

### Components of the xControl

---

#### 11.0.1 xControl – CP-G

---

(Control Panel – Generator)

Art.-No. 21.02.02.204P

**Display and Control unit element of the xControl Series.**

*Fig. 11.0.1-1: Control Panel - Generator*



The xControl CP-G is the display and operating element for the xControl System.

Power is supplied via the bus cable. Multiple remote control panels can be installed within the system.

#### 11.0.2 xControl – GC-S

---

(Generator Control - Servo)

Art.No. 21.02.08.019P

**Main module of the xControl series.**

**The module contains the entire control electronics.**

The xControl GC-S is normally mounted inside of the generator capsule.

*Fig. 11.0.2-1: Generator Control - Servo*



The xControl GC-S takes over the control and monitoring of the diesel engine of a Fischer Panda generator as well

as the control of the output voltage and the generator speed.

The xControl GC-S is suitable for both, 12 V and 24 V starter battery systems. The connected consumers are provided with the supply voltage through the switching outputs.

*The current measurement is single-phase and can be done directly by an external current sensor. An additional three-phase measuring module is necessary for three-phase generators.*

### 11.0.3 xControl - CB-G

---

(Connection Box - Generator)

**The xControl CB-G is normally mounted outside at the generator capsule.**

Fig. 11.0.3-1: Connection Box - Generator



The xControl CB-G is the external interface of the generator equipped with a xControl System.

The panel and the fuel pump are connected at this interface. It is optionally possible to connect emergency stop, auto start, load contactor and boost.

**Only a electrical trained person should do any work at xControl CB-G.**      **Note:**



## Installation

---

---

### 11.0.4 Installation of the Electronic Control Unit (ECU) xControl - GC-S

---

The ECU xControl - GC-S is pre-installed. The ECU can easily be replaced. All connectors are mechanical coded and not interchangeable.

### 11.0.5 Installation of the Connection Box xControl - CB-G

---

The connection Box is pre-installed. For the connection of the external units, see the installation guide and wiring diagram of your generator.

### 11.0.6 Installation of the xControl - CP-G

---

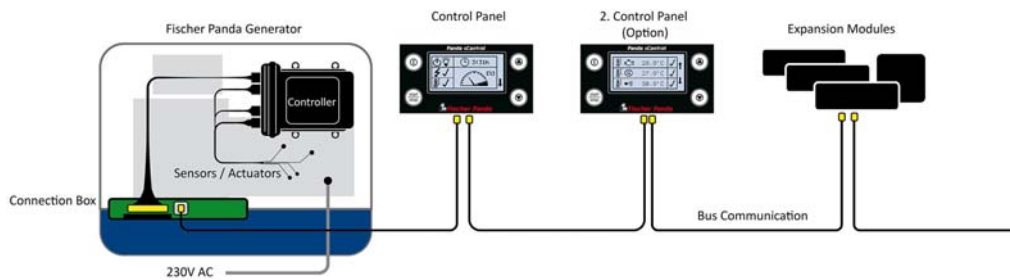
The xControl - CP-G is a CAN Bus module. All Fischer Panda Can Bus modules has two RJ45 sockets. One is to connect the module to the CAN Bus. In the second another Modul can be plugged in to continue the CAN Bus. The

last module in the row must have a termination resistor plugged into the second RJ45 socket. It is mandatory to use the Fischer Panda bus cable to connect the modules.

Fig. 11.0-1: xControl CP-G Reverse Side



Fig. 11.0-2: Connection Schema



## Operation

The xControl will be controlled with the xControl CP-G panel.

Fig. 11.0-3: xControl CP-G Front Side



### 11.0.7 Switching on the generator

Press the „ON/OFF“ Button to switch the generator on

With this you switch the generator into the standby mode.

If the automatic start option is set in the menu, the generator may start by an external signal.

Fig. 11.0.7-1: Switch the generator on



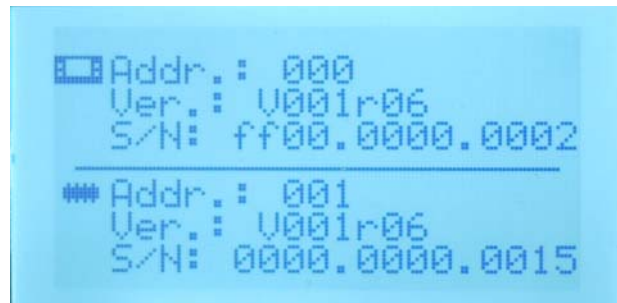
The CP-G Panel shows the welcome screen for 2 seconds.

Fig. 11.0.7-2: Welcome screen



After that the CP-G shows the address screen for 1 second

Fig. 11.0.7-3: Address screen



At the end of the switch on, the CP-G Panel will show the first overview screen.

Fig. 11.0.7-4: Overview screen 1 symbolic

Which screen the display shows (symbolic-english text-german text) can be set up in the menu.

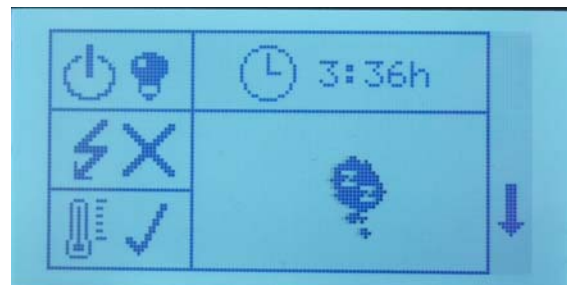


Fig. 11.0.7-5: Overview screen 1 english text

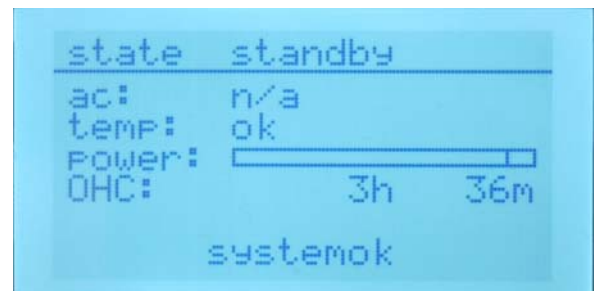
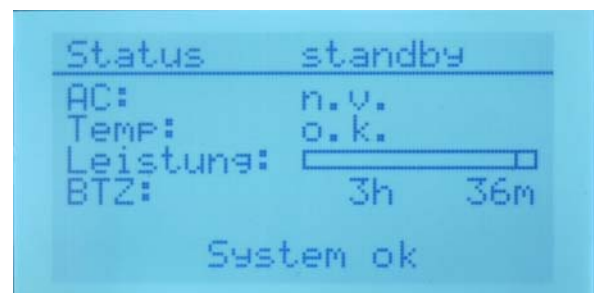


Fig. 11.0.7-6: Overview screen 1 german text



### 11.0.7.1 Overview screen with activated autostart

Danger for life! - The generator can be equipped with a automatic start device. This means the generator can be started by an external signal. To avoid an unexpected starting of the generator, the starter battery must be disconnected before start working at the generator.

#### Warning! Automatic start



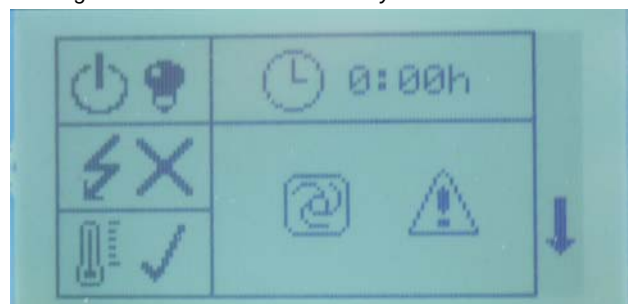
**The „Automatic Start“ will remain activated, even if the xControl CP-G is switched off and on again.**

If any failure occur while the generator is starting or running, the generator will stop and the „Automatic Start“ will fall back to „off“.

**The first overview screen will shows you, if the autostart is enabled**

Overview screen 1 symbolic with autostart enabled

Fig. 11.0.7-1: Overview screen 1 symbolic with autostart





## 11.0.8 The Overview Screens

Which overview screen the display shows (symbolic-english text-german text) can be set up in the menu.

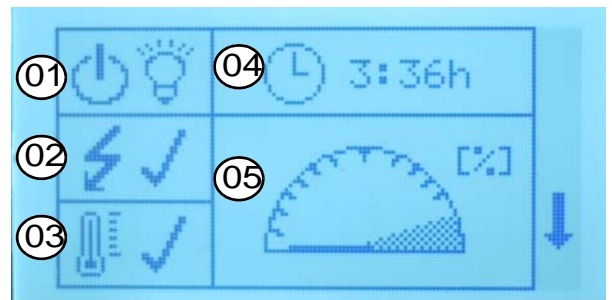
## 11.0.9 Overview Screens Symbolic

Which screen the display shows (symbolic or english text or german text) can be set up in the menu.

### The first screen shows:

01. Generator status
02. AC present
03. Temperature of the generator ok
04. Operating hours of the generator
05. Percentage of power

Fig. 11.0.9-1: Overview screen 1 symbolic



### The second screen shows

06. Voltage of the generator
07. Current of the generator
08. Power (kVA) of the generator

Fig. 11.0.9-2: Overview screen 2 symbolic



**At 3 phase generator the voltage, the current and power will be displayed on separate screens. Each screen shows the value for the 3 phases one below the other.**

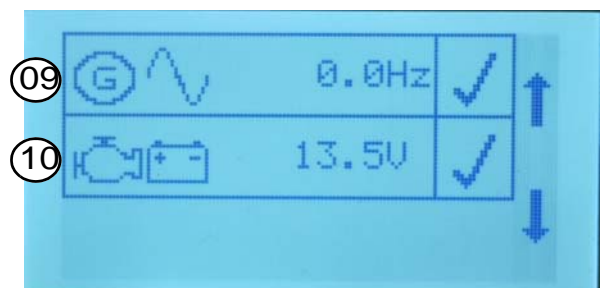
**Note:**



### The third screen shows

09. Frequency of the generator
10. Voltage of the starter battery

Fig. 11.0.9-3: Overview screen 3 symbolic



**The fourth screen shows**

- 11. Temperature of the cylinder head
- 12. Temperature of the generator coil
- 13. Temperature of the exhaust

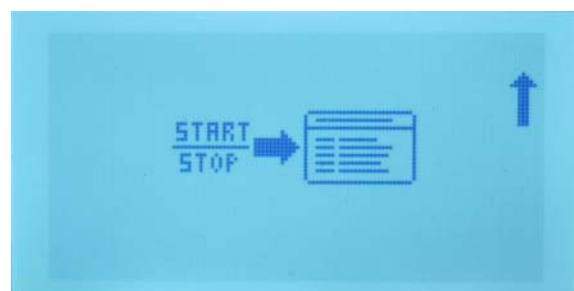
Fig. 11.0.9-4: Overview screen 4 symbolic



**The fifth screen is the „Enter the menu“ screen.**

Press the Start/Stop - Enter button to enter the menu

Fig. 11.0.9-5: Overview screen 5 symbolic



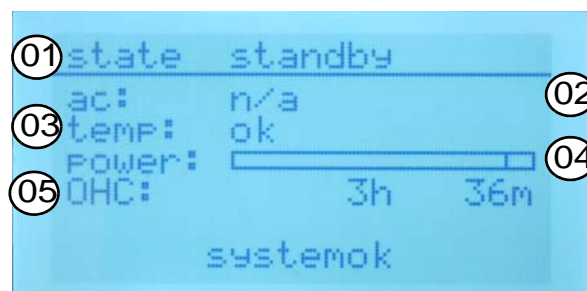
**11.0.10 Overview Screens English Text**

Which screen the display shows (symbolic or english text or german text) can be set up in the menu.

**The first screen shows:**

- 01. Generator status
- 02. AC present
- 03. Temperature of the generator ok
- 04. Percentage of power
- 05. Operating hours of the generator

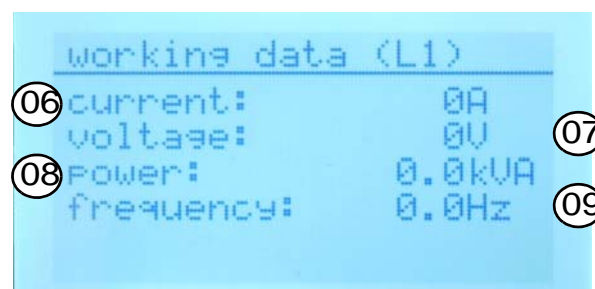
Fig. 11.0.10-1: Overview screen 1 english text



**The second screen shows**

- 06. Voltage of the generator
- 07. Current of the generator
- 08. Power (kVA) of the generator
- 09. Frequency of the generator

Fig. 11.0.10-2: Overview screen 2 english text



**At 3 phase generator the voltage, the current and power will be displayed on separate screens. Each screen shows the value for the 3 phases one below the other.** Note:

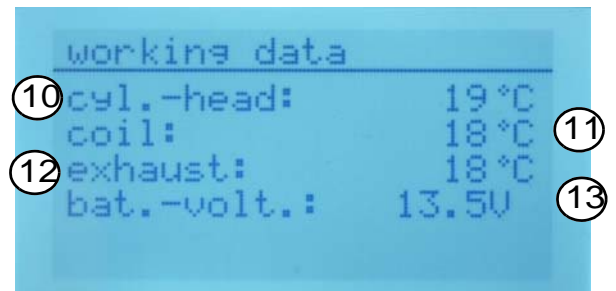




### The third screen shows

10. Temperature of the cylinder head
11. Temperature of the generator coil
12. Temperature of the exhaust
13. Voltage of the starter battery

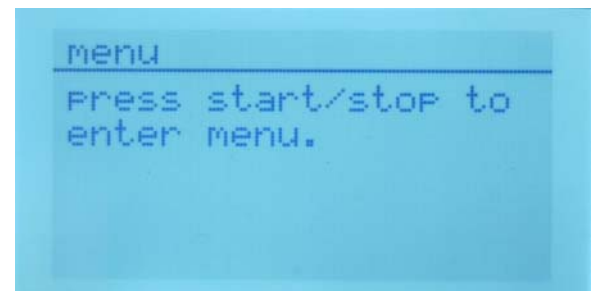
Fig. 11.0.10-3: Overview screen 3 english text



### The fourth screen is the „Enter the menu“ screen.

Press the Start/Stop - Enter button to enter the menu

Fig. 11.0.10-4: Overview screen 4 english text



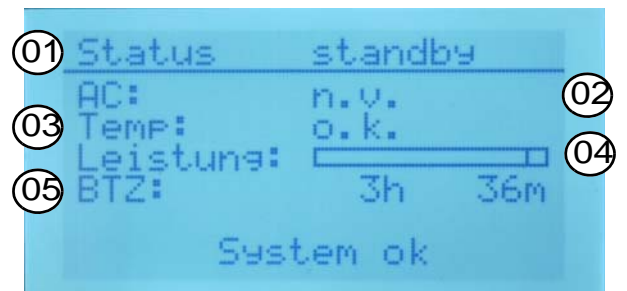
## 11.0.11 Overview Screens German Text

Which screen the display shows (symbolic or english text or german text) can be set up in the menu.

### The first screen shows:

01. Generator status
02. AC present
03. Temperature of the generator ok
04. Percentage of power
05. Operating hours of the generator

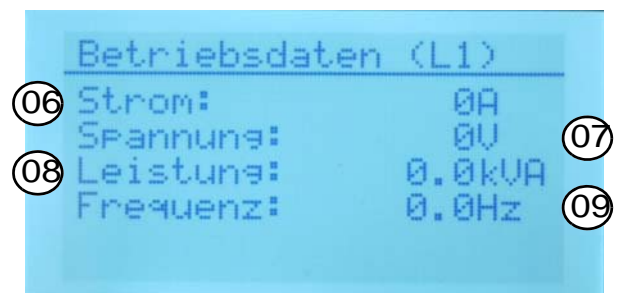
Fig. 11.0.11-1: Overview screen 1 german text



### The second screen shows

06. Voltage of the generator
07. Current of the generator
08. Power (kVA) of the generator
09. Frequency of the generator

Fig. 11.0.11-2: Overview screen 2 german text



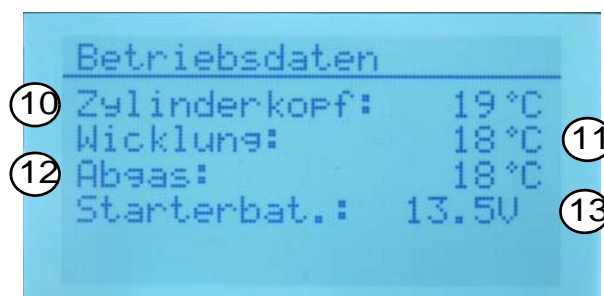
**At 3 phase generator the voltage, the current and power will be displayed on separate screens. Each screen shows the value for the 3 phases one below the other.**

**Note:**

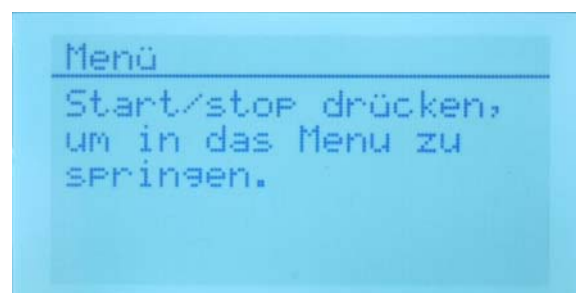


**The third screen shows**

10. Temperature of the cylinder head
11. Temperature of the generator coil
12. Temperature of the exhaust
13. Voltage of the starter battery

*Fig. 11.0.11-3: Overview screen 3 german text***The fourth screen is the „Enter the menu“ screen.**

Press the Start/Stop - Enter button to enter the menu

*Fig. 11.0.11-4: Overview screen 4 german text*

## 11.1 Start of the Generator

---

---

### 11.1.1 Marine version starting preparation / Checks (daily)

---

1. Oil level control (ideal level: 2/3 MAX).

The level should be about 2/3 of the maximum level of a cold engine.

Further, if installed, the oil level of the oil-cooled bearing must be controlled before each start - see sediment bowl at generator front cover!.

2. State of cooling water.

The external expansion tank should be filled up to 1/3 of the maximum in a cold state. It is very important that a large expansion area remains above the cooling water level.

3. Check if sea cock for cooling water intake is open.

For safety reasons, the sea cock must be closed after the generator has been switched off. It should be re-opened before starting the generator.

4. Check raw water filter.

The raw water filter must be regularly checked and cleaned. The impeller fatigue increases, if residual affects the raw water intake.

5. Visual inspection.

Control fixing bolts, check hose connectors for leakages, control electrical connections.

6. Switch off the load.

The generator should only be started without load.

7. Open fuel valve, if installed.

8. Close battery main switch (on).

### 11.1.2 Vehicle version starting preparation / Checks (daily)

---

1. Oil level control (ideal level: 2/3 MAX).

The level should be about 2/3 of the maximum level of a cold engine.

Further, if installed, the oil level of the oil-cooled bearing must be controlled before each start - see sediment bowl at generator front cover!.

2. State of cooling water.

The external expansion tank should be filled up to 1/3 of the maximum in a cold state. It is very important that a large expansion area remains above the cooling water level.

3. Visual inspection.

Control fixing bolts, check hose connectors for leakages, control electrical connections.

4. Switch off the load.

The generator should only be started without load.

5. Open fuel valve, if installed.

6. Close battery main switch (on).

### 11.1.3 Starting the generator

**Danger for life!** - The generator can be equipped with a automatic start device. This means the generator can be started by an external signal. To avoid an unexpected starting of the generator, the starter battery must be disconnected before start working at the generator.

**Warning! Automatic start**



1. Switch the xControl CP-G on  
Wait till the overview screen appear

Fig. 11.1.3-1: Panel on



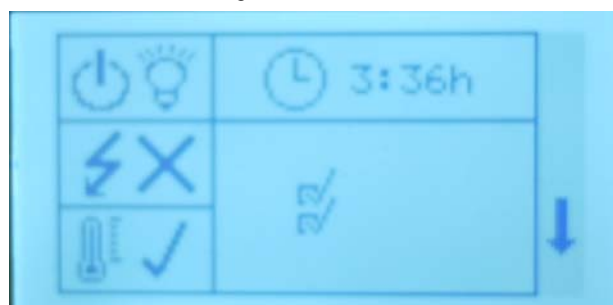
2. Press the Start/Stop - Enter button

Fig. 11.1.3-2: Start



3. The xControl will make a self test.

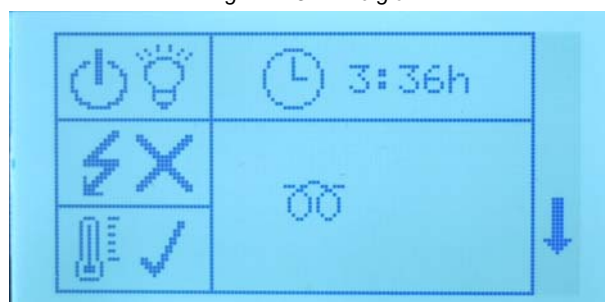
Fig. 11.1.3-3: Self test



4. The xControl pre glow the generator engine

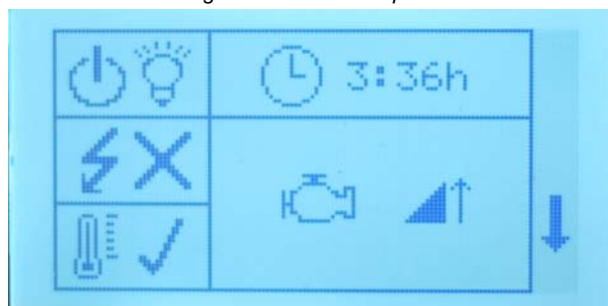
Fig. 11.1.3-4: Pre glow

After the pre glow the engine will be started by the xControl.



The first seconds the engine run on idle speed. After that the xControl raises the speed to nominal and shows it in the display.

Fig. 11.1.3-5: Raise speed



As soon as the AC ok is shown, the load can be switched on the generator.

Fig. 11.1.3-6: AC OK



**In the event of starting problems, close the sea water inlet cock. Panda marine generators only.**

Should there be any reason to turn the engine (over) or start the engine i.e. to bleed the fuel system, the sea water inlet cock must be closed! During the starting process, the cooling water pump is driven with the motor. The cooling water is discharged to the exhaust outlet and, since the motor has not run, the exhaust pressure is not high enough to expel the sea water which has been brought to the exhaust outlet. To avoid filling the exhaust outlet with water and causing further problems, close the inlet sea water valve.

**Attention!**



*Once the engine is running, be sure to open the inlet valve!*

#### 11.1.4 Stopping the generator

1. Switch off load.
2. Recommendation: With turbo engines and during load more than highly 70 % of the rated output, stabilize generator temperature at least 5 minutes with load switched off.

At higher ambient temperatures (more than 25 °C) the generator should always run for at least 5 minutes without load, before it is switched off, regardless of the load.

3. To stop the generator, press the Start Stop - Enter button.

Fig. 11.1.4-1: Stop



**Never switch off the battery until the generator has stopped, if necessary close fuel valve!**

**Attention!**



## The Menu

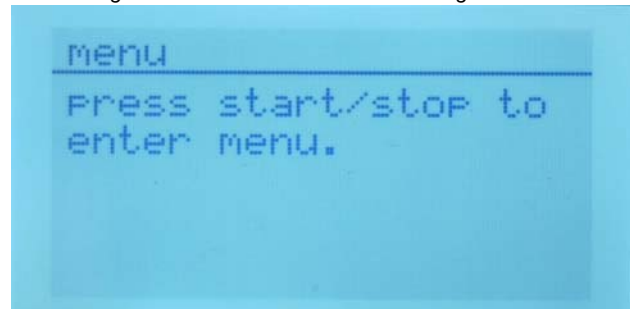
The Last screen of the overview is the „Enter the menu screen“.

Switch the CP-G on and scroll down with the „step down“ button until you reach the „Enter the menu screen“

Fig. 11.1-2: Enter the menu screen symbolic

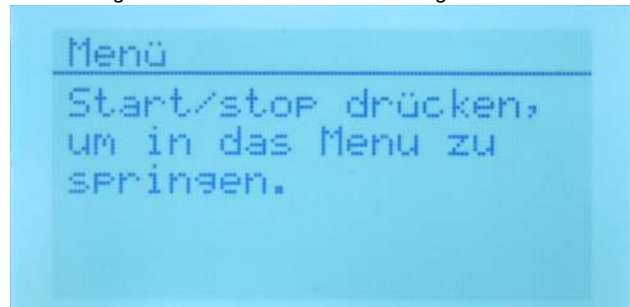


Fig. 11.1-3: Enter the menu screen englisch text



Press the start/Stop - Enter button to enter the menu.

Fig. 11.1-4: Enter the menu screen german text

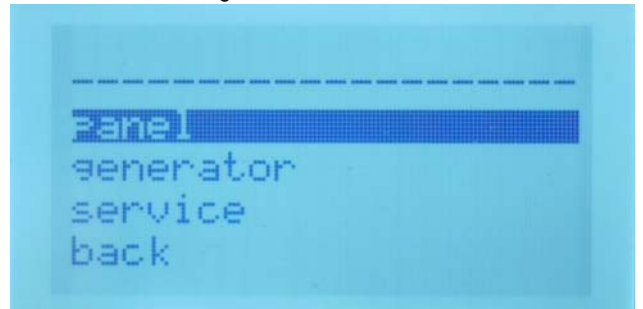


### 11.1.5 Main Menu

---

In the „Main Menu“, you can choose between the submenus:

Fig. 11.1.5-1: Main Menu



1. Submenu „Panel“

*in the submenu „Panel“ you can change all panel settings like „Brightness“, „Language“ etc.*

2. Submenu „Generator“

*in the submenu „Generator“ you can change the generator relevant settings. For example Switch on the fuel pump for deaerating etc.*

3. Service

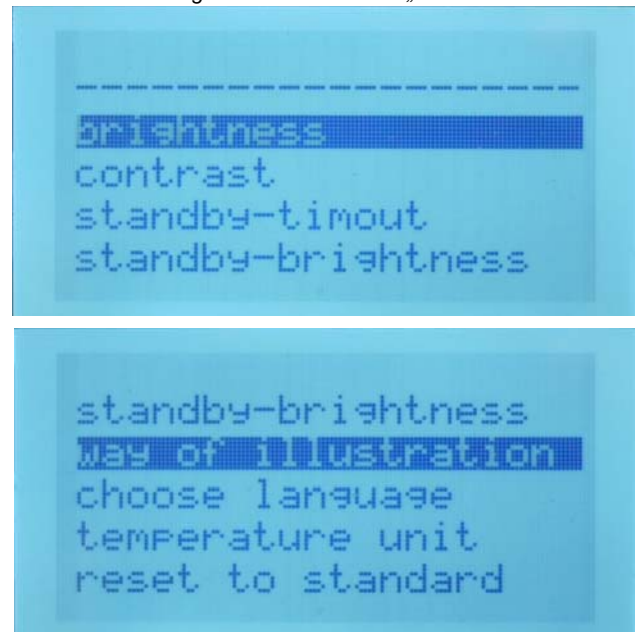
*the submenu „Service“ is a restricted area for Fischer Panda Staff.*

4. Back

### 11.1.6 Submenu „Panel“

---

Fig. 11.1.6-1: Submenu „Panel“



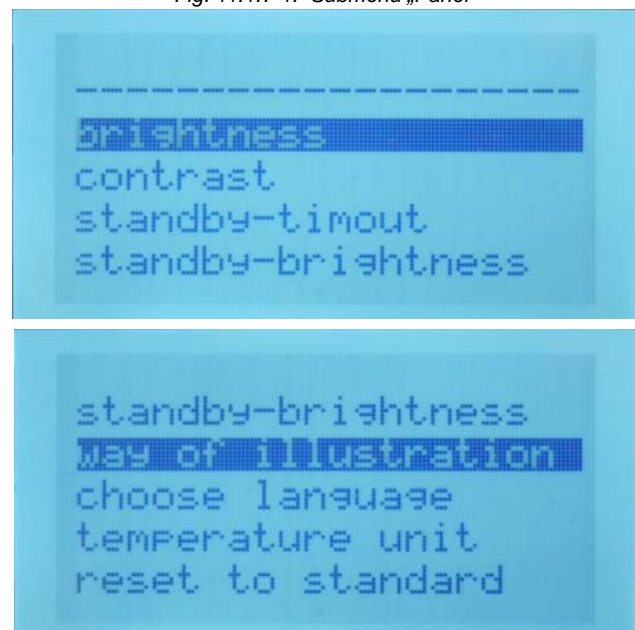
### 11.1.7 Submenu „Generator“

---

In the submenu „Panel“ following points can be set up

1. Brightness of the panel
2. Contrast of the panel
3. Standby time out of the Panel
4. Standby brightness of the panel
5. Way of illustration (symbolic or text) of the overview screens
6. Language of the text screens
7. Temperature unit (°C or °F)
8. Reset the panel submenu to standard
9. back to the main menu

Fig. 11.1.7-1: Submenu „Panel“



#### 11.1.7.1 Set up the brightness of the CP-G

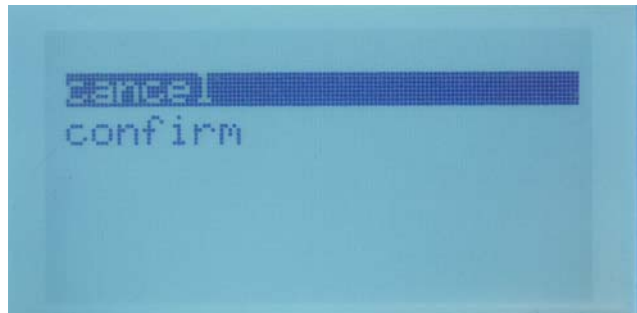
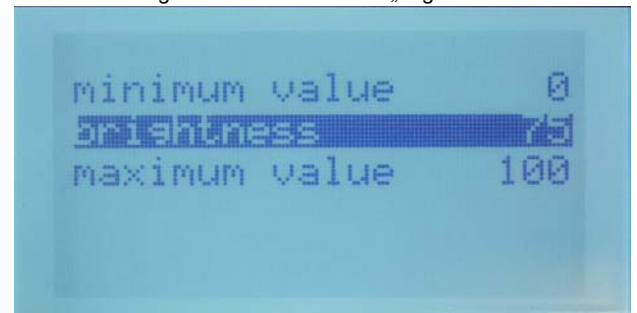
Scroll with the „Step-up“/“Step-down“ buttons to the menu point „brightness“ and confirm with the „Start/Stop - Enter“ button. You enter the menu point brightness.



Increase /decrease with the „Step-up“/“Step-down“ buttons the value and confirm with the „Start/Stop - Enter“ button.

Choose cancel or confirm with the „Step-up“/“Step-down“ buttons and confirm with the „Start/Stop - Enter“ button.

Fig. 11.1.7.1-1: Submenu „brightness“



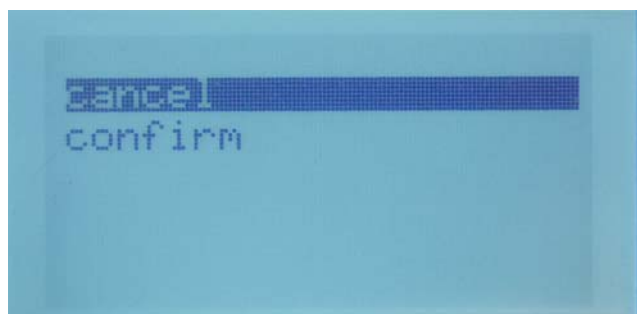
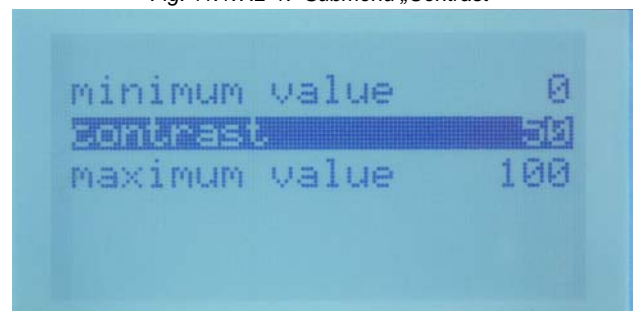
### 11.1.7.2 Set up the contrast of the CP-G

Scroll with the „Step-up“/“Step-down“ buttons to the menu point „contrast“ and confirm with the „Start/Stop - Enter“ button. You enter the menu point contrast.

Increase /decrease with the „Step-up“/“Step-down“ buttons the value and confirm with the „Start/Stop - Enter“ button.

Choose cancel or confirm with the „Step-up“/“Step-down“ buttons and confirm with the „Start/Stop - Enter“ button.

Fig. 11.1.7.2-1: Submenu „Contrast“



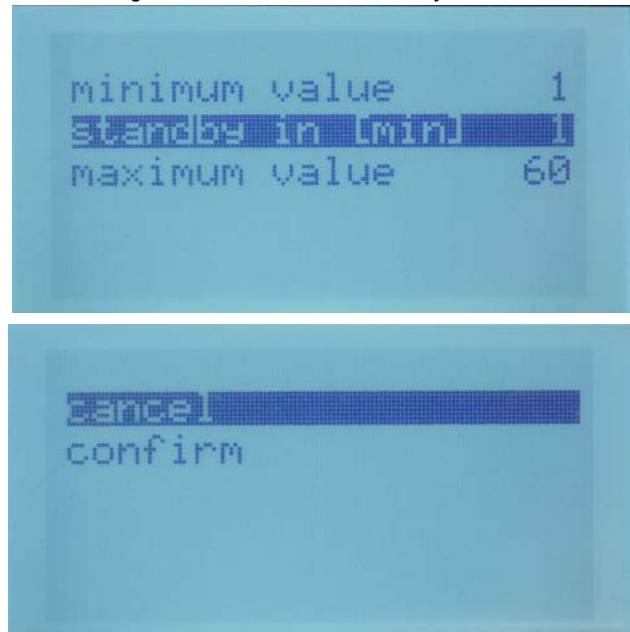
### 11.1.7.3 Set up the standby time out of the CP-G

Scroll with the „Step-up“/“Step-down“ buttons to the menu point „standby time out“ and confirm with the „Start/Stop - Enter“ button. You enter the menu point standby time out.

Increase /decrease with the „Step-up“/“Step-down“ buttons the value and confirm with the „Start/Stop - Enter“ button.

Choose cancel or confirm with the „Step-up“/“Step-down“ buttons and confirm with the „Start/Stop - Enter“ button.

Fig. 11.1.7.3-1: Submenu „standby timeout“



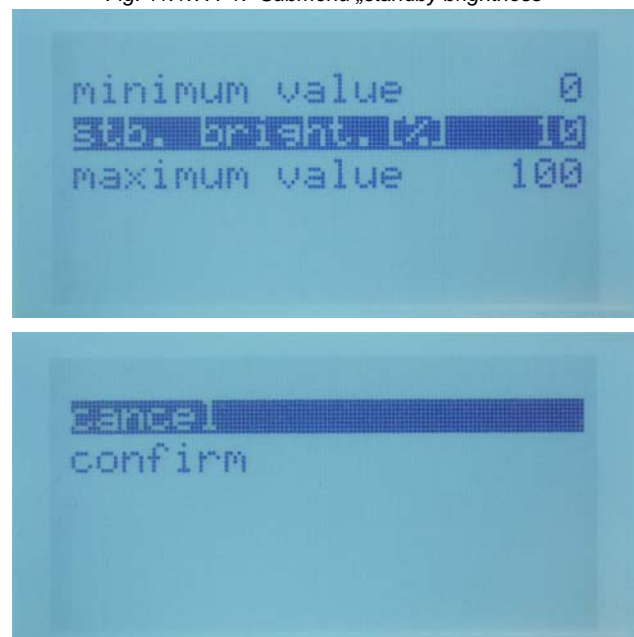
#### 11.1.7.4 Set up the standby brightness of the CP-G

Scroll with the „Step-up“/“Step-down“ buttons to the menu point „standby brightness“ and confirm with the „Start/Stop - Enter“ button. You enter the menu point standby brightness.

Increase /decrease with the „Step-up“/“Step-down“ buttons the value and confirm with the „Start/Stop - Enter“ button.

Choose cancel or confirm with the „Step-up“/“Step-down“ buttons and confirm with the „Start/Stop - Enter“ button.

Fig. 11.1.7.4-1: Submenu „standby brightness“



#### 11.1.7.5 Set up the way of illustration of the overview screens of the CP-G

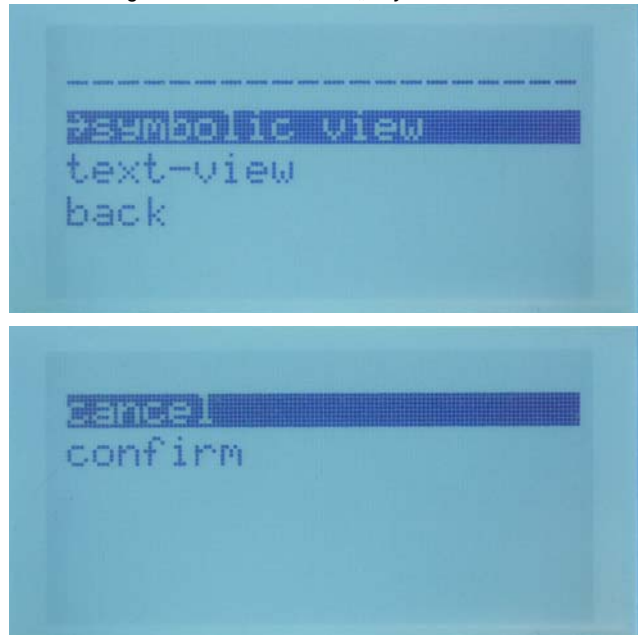
Scroll with the „Step-up“/“Step-down“ buttons to the menu point „way of illustration“ and confirm with the „Start/Stop - Enter“ button. You enter the menu point way of illustration.

Choose „symbolic view“ or text view“ with the „Step-up“/“Step-down“ buttons and confirm with the „Start/Stop - Enter“ button.

Choose cancel or confirm with the „Step-up“/“Step-down“ buttons and confirm with the „Start/Stop - Enter“ button.

If you choose „back“ you return into the submenu „panel“ without the „cancel/confirm screen“.

Fig. 11.1.7.5-1: Submenu „way of illustration“



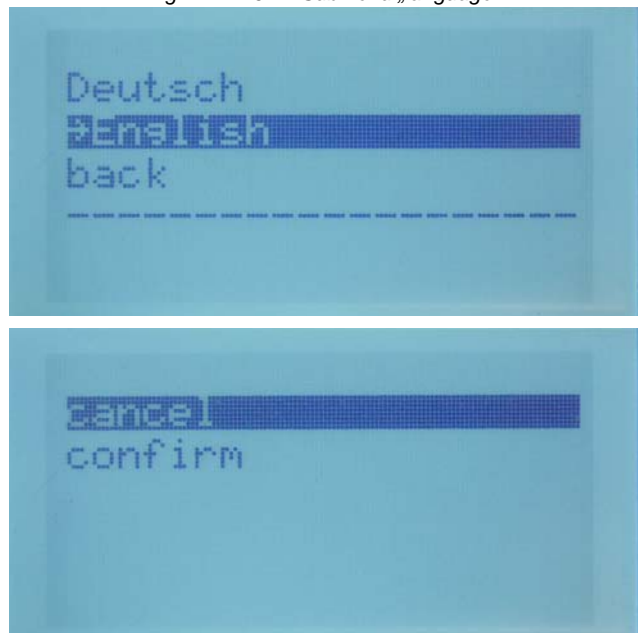
### 11.1.7.6 Choose the language of the text screens of the CP-G

Scroll with the „Step-up“/“Step-down“ buttons to the menu point „language“ and confirm with the „Start/Stop - Enter“ button. You enter the menu point language.

Choose „Deutsch“ or „English“ with the „Step-up“/“Step-down“ buttons and confirm with the „Start/Stop - Enter“ button.

Choose cancel or confirm with the „Step-up“/“Step-down“ buttons and confirm with the „Start/Stop - Enter“ button.

Fig. 11.1.7.6-1: Submenu „language“



### 11.1.7.7 Set up temperature unit

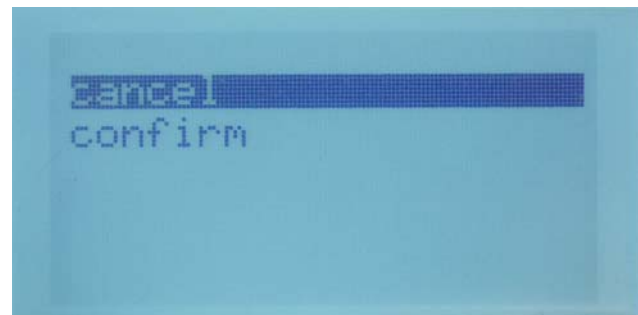
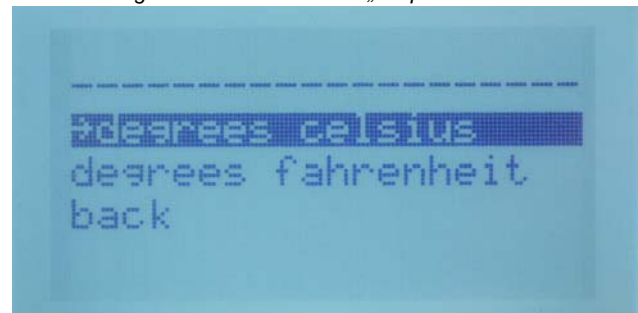
Scroll with the „Step-up“/“Step-down“ buttons to the menu point „temperature unit“ and confirm with the „Start/Stop - Enter“ button. You enter the menu point temperature unit.

Choose „degrees celsius“ or „degrees fahrenheit“ with the „Step-up“/„Step-down“ buttons and confirm with the „Start/Stop - Enter“ button.

Choose cancel or confirm with the „Step-up“/„Step-down“ buttons and confirm with the „Start/Stop - Enter“ button.

If you choose „back“ you return into the submenu „panel“ without the „cancel/confirm screen“.

Fig. 11.1.7.7-1: Submenu „temperature unit“

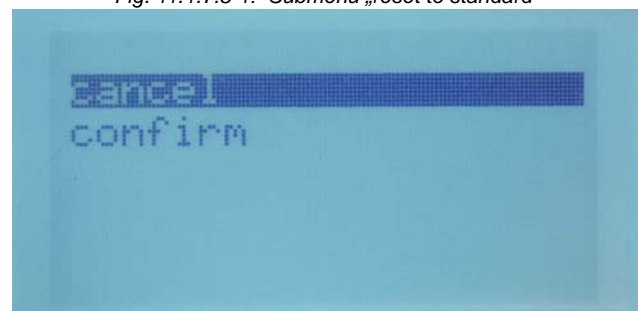


### 11.1.7.8 Reset all values of the panel submenu to standard

Scroll with the „Step-up“/„Step-down“ buttons to the menu point „reset to standard“ and confirm with the „Start/Stop - Enter“ button.

Choose cancel or confirm with the „Step-up“/„Step-down“ buttons and confirm with the „Start/Stop - Enter“ button.

Fig. 11.1.7.8-1: Submenu „reset to standard“



### 11.1.7.9 Back to the main menu

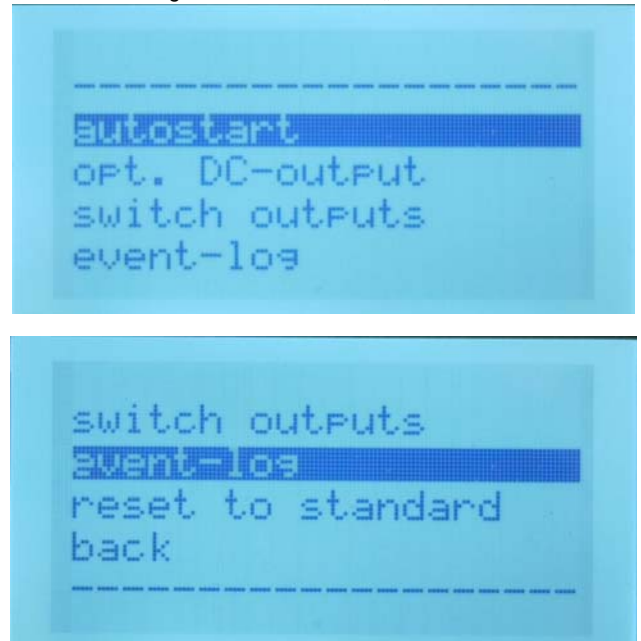
Scroll with the „Step-up“/„Step-down“ buttons to the menu point „back“ and confirm with the „Start/Stop - Enter“ button.

### 11.1.8 Submenu „Generator“

In the submenu „Generator“ following points can be set up

1. Autostart enable
2. Optional DC output
3. Switch outputs
4. Event log
5. Reset the generator submenu to standard
6. back to the main menu

Fig. 11.1.8-1: Submenu „Generator“



#### 11.1.8.1 Set up the autostart of the CP-G

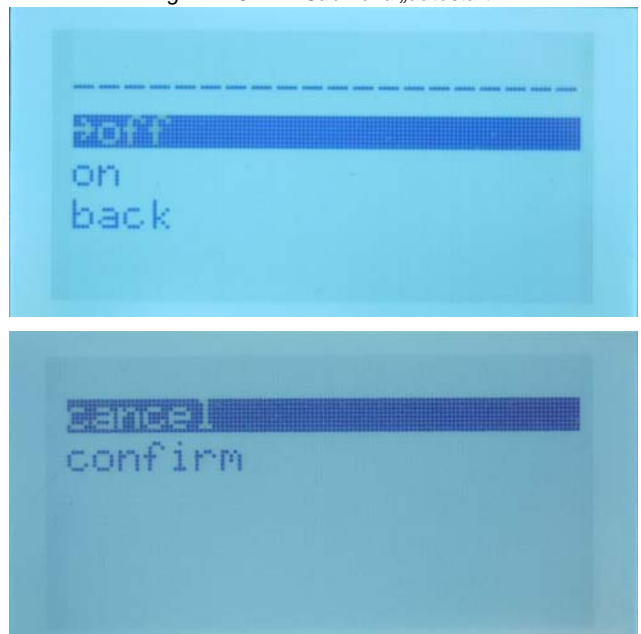
Scroll with the „Step-up“/„Step-down“ buttons to the menu point „autostart“ and confirm with the „Start/Stop - Enter“ button. You enter the menu point autostart.

Choose „off“ or „on“ with the „Step-up“/„Step-down“ buttons and confirm with the „Start/Stop - Enter“ button.

Choose cancel or confirm with the „Step-up“/„Step-down“ buttons and confirm with the „Start/Stop - Enter“ button.

If you choose „back“ you return into the submenu „panel“ without the „cancel/confirm screen“.

Fig. 11.1.8.1-1: Submenu „autostart“



**Danger for life! - The generator can be equipped with a automatic start device. This means the generator can be started by an external signal. To avoid an unexpected starting of the generator, the starter battery must be disconnected before start working at the generator.**

**Warning! Automatic start**



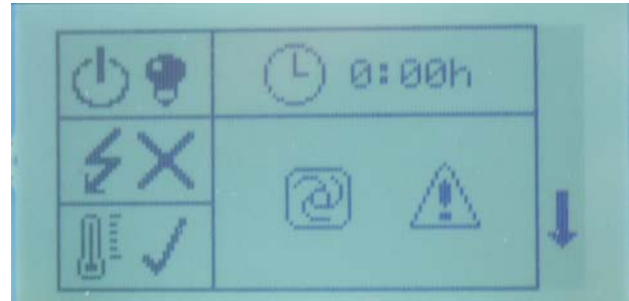
The „Automatic Start“ will remain activated, even if the xControl CP-G is switched off and on again.

If any failure occur while the generator is starting or running, the generator will stop and the „Automatic Start“ will fall back to „off“.

**The first overview screen will show you, if the autostart is enabled**

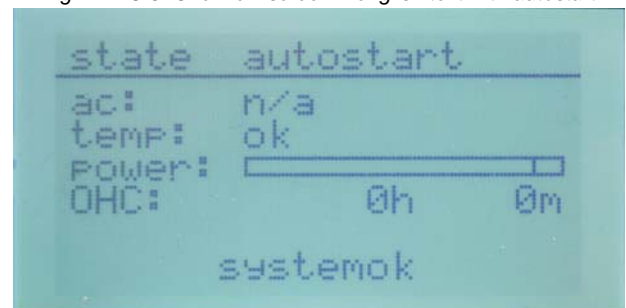
Overview screen 1 symbolic with autostart enabled

Fig. 11.1.8-2: Overview screen 1 symbolic with autostart



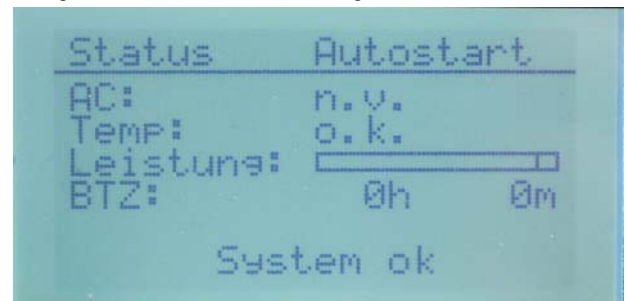
Overview screen 1 english text with autostart enabled

Fig. 11.1.8-3: Overview screen 1 english text with autostart



Overview screen 1 german text with autostart enabled

Fig. 11.1.8-4: Overview screen 1 german text with autostart



**If the generator is running in the autostart mode and stopped manually, the autostart will fall back to „off“.**

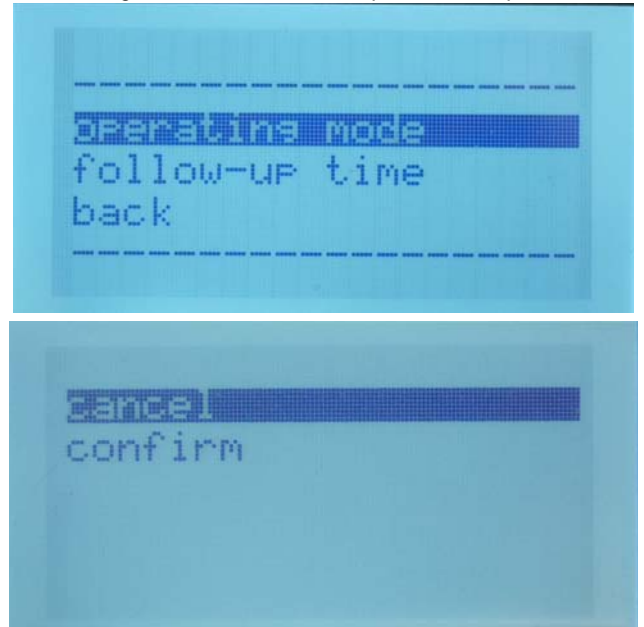
### 11.1.8.2 Set up the optional DC output of the CP-G

Scroll with the „Step-up“/„Step-down“ buttons to the menu point „optional DC output“ and confirm with the „Start/Stop - Enter“ button. You enter the menu point optional DC output.

Choose „operation mode“ or „follow-up time“ and confirm with the „Start/Stop - Enter“ button.

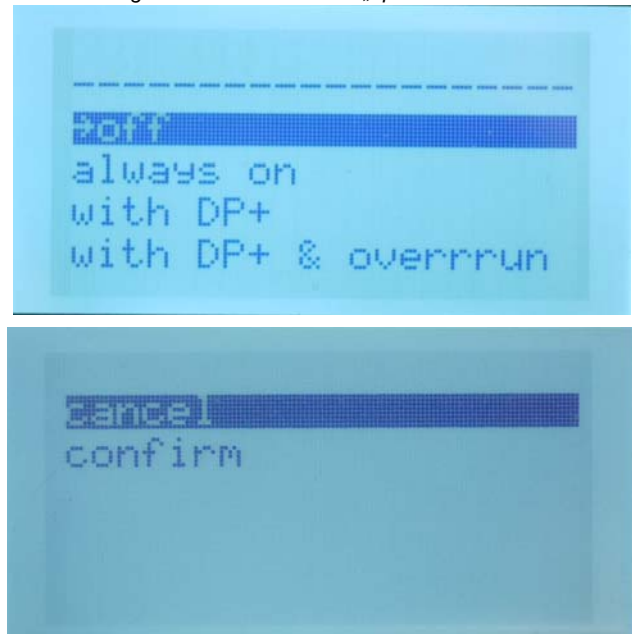
Choose cancel or confirm with the „Step-up“/„Step-down“ buttons and confirm with the „Start/Stop - Enter“ button.

Fig. 11.1.8.2-1: Submenu „optional DC output“



### 11.1.8.3 Set up the operation mode for the opt. DC-Power (DP) output of the CP-G

Fig. 11.1.8.3-1: Submenu „operation model“

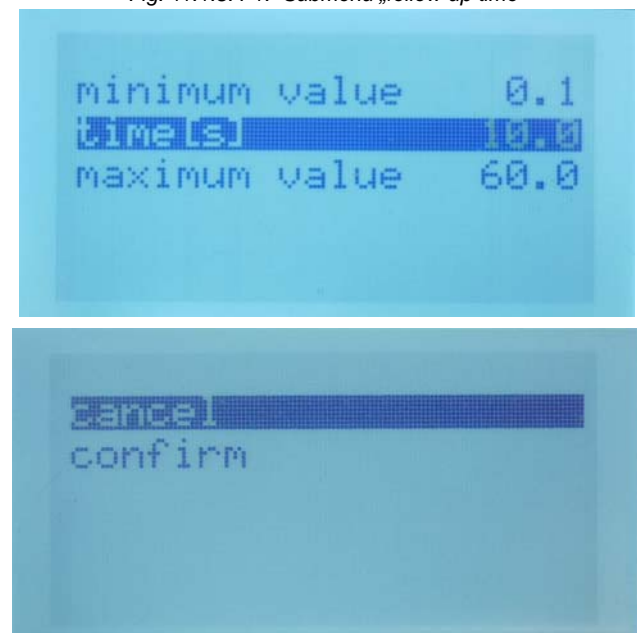


### 11.1.8.4 Set up the follow-up time for the opt. DP output of the CP-G

Increase /decrease with the „Step-up“/“Step-down“ buttons the value and confirm with the „Start/Stop - Enter“ button.

Choose cancel or confirm with the „Step-up“/“Step-down“ buttons and confirm with the „Start/Stop - Enter“ button.

Fig. 11.1.8.4-1: Submenu „follow-up time“



### 11.1.8.5 Switch the outputs of the CP-G

Scroll with the „Step-up“/“Step-down“ buttons to the menu point „switch outputs“ and confirm with the „Start/Stop - Enter“ button. You enter the menu point switch outputs.

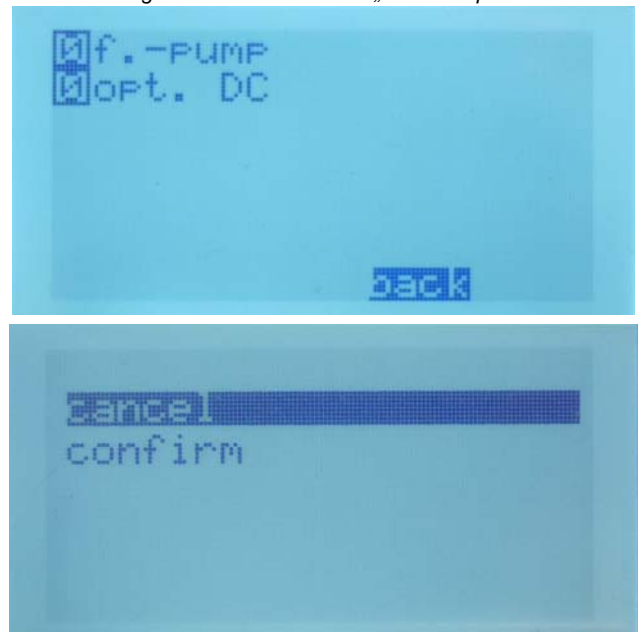


Choose „f.-pump“ or „opt. DC“ with the „Step-up“/“Step-down“ and change the value from 0 to 1 or back with the „Start/Stop - Enter“ button.

If you set the value to „1“ the output will be switched on, if you set the value to „0“ the output will switched off.

To return to the generator menu choose „back“ with the „Step-up“/“Step-down“ buttons and confirm with the „Start/Stop - Enter“ button.

Fig. 11.1.8.5-1: Submenu „switch outputs“



### 11.1.8.6 Check the event log of the CP-G

Scroll with the „Step-up“/“Step-down“ buttons to the menu point „event-log“ and confirm with the „Start/Stop - Enter“ button. You enter the menu point event-log.

Fig. 11.1.8.6-1: Submenu „event-log“



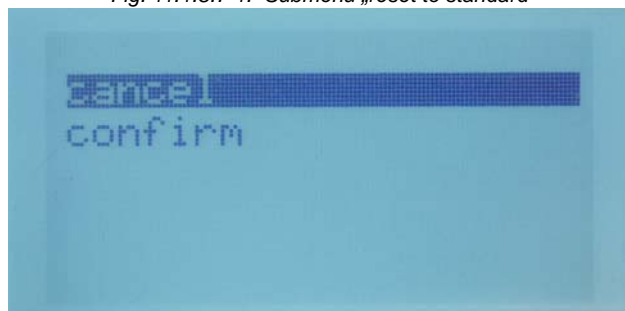
Scroll through the event log with the „Step-up“/“Step-down“ buttons and return to the generator menu with the „Start/Stop - Enter“ button.

### 11.1.8.7 Reset all values of the generator submenu to standard

Scroll with the „Step-up“/“Step-down“ buttons to the menu point „reset to standard“ and confirm with the „Start/Stop - Enter“ button.

Choose cancel or confirm with the „Step-up“/„Step-down“ buttons and confirm with the „Start/Stop - Enter“ button.

Fig. 11.1.8.7-1: Submenu „reset to standard“



### 11.1.8.8 Back to the main menu

Scroll with the „Step-up“/„Step-down“ buttons to the menu point „back“ and confirm with the „Start/Stop - Enter“ button.

### 11.1.9 How to change the menu text from german to english

---

1. Turn the xControl Panel on.
2. Wait till the first overview screen appear.
3. Scroll down till the last overview screen appear
4. Press the „Start/Stop - Enter“ button to enter the menu.
5. Scroll down to „Panel“.
6. Press the „Start/Stop - Enter“ button to enter the panel submenu.
7. Scroll down to „Sprachwahl“.
8. Press the „Start/Stop - Enter“ button to enter the language submenu.
9. Scroll down to „Englisch“ and confirm with the „Start/Stop -Enter“ button

The menu text is now changed to english text.

## 11.2 Failure

### 11.2.1 Symbols and Messages in the Display

#### 11.2.1.1 Message sample „Sensor defect“

As soon as a defect sensor is detected, the xControl shows it in the display

Fig. 11.2.1.1-1: Sensor defect symbolic



Fig. 11.2.1.1-2: Sensor defect english

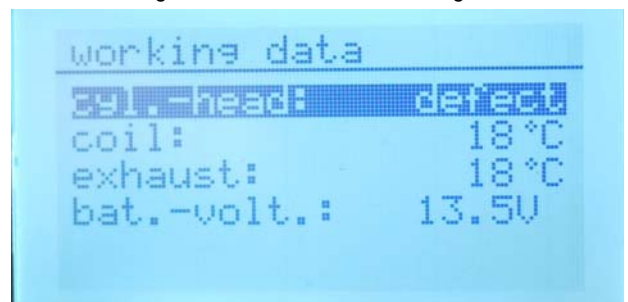
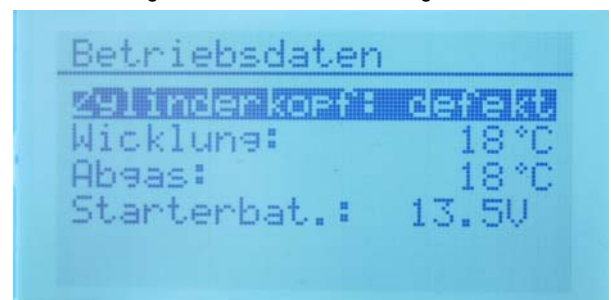


Fig. 11.2.1.1-3: Sensor defect german



#### 11.2.1.2 Message sample sensor/cable broken

If the sensor or the cable is broken following messages appear:

Fig. 11.2.1.2-1: Sensor broken symbolic

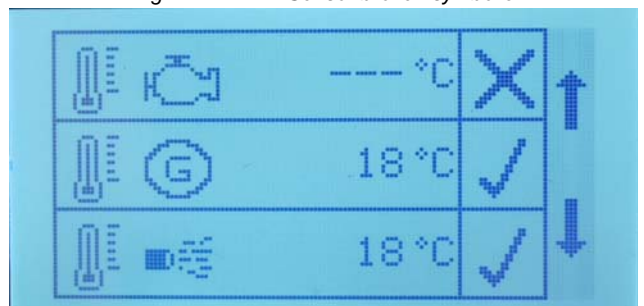


Fig. 11.2.1.2-2: Sensor broken english

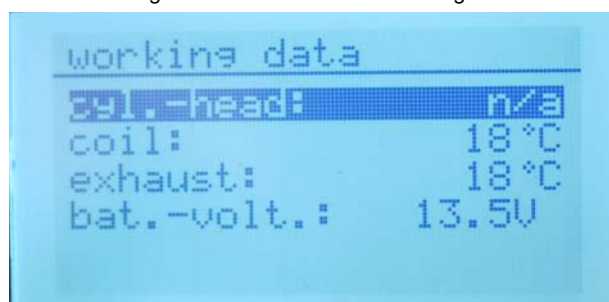
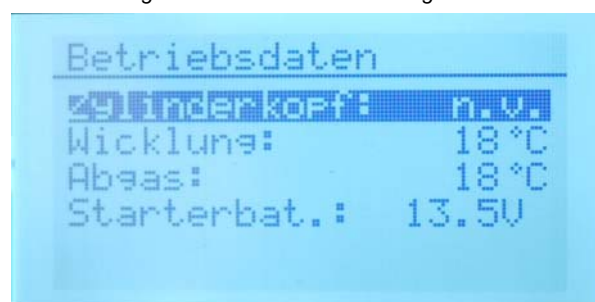


Fig. 11.2.1.2-3: Sensor broken german



### 11.2.1.3 Failure code

A Failure code is shown if any parameter run out of the specified range.

see "Failuretable" on page 180

Fig. 11.2.1.3-1: Failure code



## 11.2.2 Failuretable

See chapter „Failure“ of your generator manual for help.

Fig. 11.2-1: Failure codes











No..	Description	Cause	Explication	Warning	Gen.Stop	Info
1	AC-Voltage	Voltage to low		yes	yes	n.a.
2	AC-Frequency	Frequency to low		yes	yes	n.a.
5	Emergency	Emergency button pushed	Contact „emergency“ open	n.a.	yes	n.a.
7	Oil pressure	Oil pressure to low	Failure oil pressure switch	n.a.	yes	n.a.
13	Starter power	Starter failure	short circuit Starter defect	yes	n.a.	n.a.
14	Glow circuit	Glow circuit failure	short circuit defect	yes	n.a.	n.a.
16	Fuel supply	Failure fuel supply	short circuit defect	yes	n.a.	n.a.
17	Stop solenoid - Hold	Failure stop solenoid hold coil	short circuit	yes	n.a.	n.a.
18	Stop solenoid - Pull	Failure stop solenoid pull coil	short circuit	yes	n.a.	n.a.
19	Optional DC out	Failure optional DC out	short circuit	yes	n.a.	n.a.

No..	Description	Cause	Explication	Warning	Gen.Stop	Info
20	Current sensor	No voltage on supply current sensor	short circuit defect		Yes	
25	Battery voltage	battery voltage to low		yes	yes	
26	RPM failure	RPM out of range	Failure fuel supply Fuel empty	n.a.	yes	
29	Power out relay	Failure power out relay	Short circuit	n.a.	n.a.	
65	AC-Voltage	Voltage to high		yes	yes	
66	AC-Frequency	Frequency to high		yes	yes	
67	AC-Current	Current to high		yes	n.a.	
68	AC-Power	Load to high		yes	n.a.	
70	Servo power	Power to high	mechanical blocked. Power consumption to high, short circuit	yes	yes	
72	Temperature Cylinder head	Temp. value to high		yes	yes	
73	Temperature winding	Temp. value to high		yes	yes	
74	Temperature Exhaust	Temp. value to high		yes	yes	
75	Temperature Electronic	Temp. value to high		yes	n.a.	
77	Starter power	Starter failure	short circuit Starter defect	yes	n.a.	
78	Glow circuit	Glow circuit failure	short circuit defect	yes	n.a.	
80	Fuel supply	Failure fuel supply	short circuit defect	yes	n.a.	
81	Stop solenoid - Hold	Failure stop solenoid hold coil	short circuit	yes	n.a.	
82	Stop solenoid - Pull	Failure stop solenoid pull coil	short circuit	yes	n.a.	
83	Optional DC out	Failure optional DC out	short circuit	yes	n.a.	
89	Battery voltage	Battery voltage to high		yes	yes	
93	Power out relay	Failure power out relay	Short circuit or defect	yes	Yes	
130	No Panel found	Wrong patch cable/wrong contact	check cable/harness	n.a.	yes	n.a.
131	Communication FP BUS	Communication failure	lost communication with Panel	n.a.	yes	
132	Service interval	Service due		yes	n.a.	
133	BUS Module lost (3ph-measurement)			yes	n.a.	
134	BUS Module lost (DC-measurement)			n.a.	yes	
135	Sync failure	generators cannot be synced	second generator can not be switched to the running generator		Yes	
136	Communication motorcontroller	No data from motorcontroller	short circuit defect		Yes	
137	Airfilter	Error Airfilter	Bad airfilter		Yes	
139	Syncmodul	No data from Syncmodul	short circuit defect		Yes	
140	loadbancing	Generator takes less of load	Generator produces not enough power		Yes	
141	Configuration syncmodul	Syncmodul available but not selected	Crippled mode only		No	
246	Service done	user	Service interval reset	n.a.	n.a.	yes
251	Admin Param changed	user	Parameter changed in Admin level	n.a.	n.a.	yes

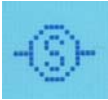





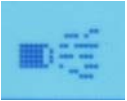



No..	Description	Cause	Explication	Warning	Gen.Stop	Info
255	Reserved			n.a.	n.a.	yes

### 11.2.3 Description of Symbols

Fig. 11.2-1: Symbols

	Warning	
	Failure shut down	
	Failure	Sensor Failure/Line open
	Broken	Sensor Broken/short circuit
	OK	
	AC Voltage	
	Current	Generator out
	Standby	
	Automatic start	
	Starter battery	



	Power	Generator out
	Load (%)	
	Generator running	
	Generator off	
	Temperature	
	Engine	
	Exhaust	
	Winding&Coil	
	Preglow	
Example:		
		
Failure+Engine+Temperature		



## Zubehör:

---

---

**FP-Bus Kabel (15 m): 34.02.02.131H**

*Fig. 11.2-2: FP-Bus Kabel (15 m): 34.02.02.131H*



**Abschlußwiderstand: 34.02.02.133H**

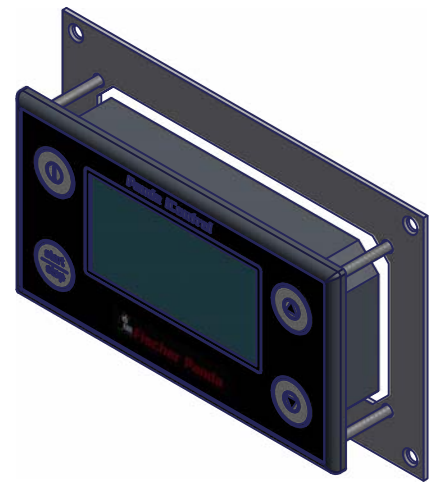
*Fig. 11.2-3: Abschlußwiderstand: 34.02.02.133H*



**Adapter Rahmen: 31.03.20.263H**

*Fig. 11.2-4: Adapter Rahmen: 31.03.20.263H*

**xControl CP-G in einem Generator Control (P6+)  
Ausschnitt**



**11.2.3.1 Dimensionszeichnung**

Fig. 11.2.3.1-1: CP-G

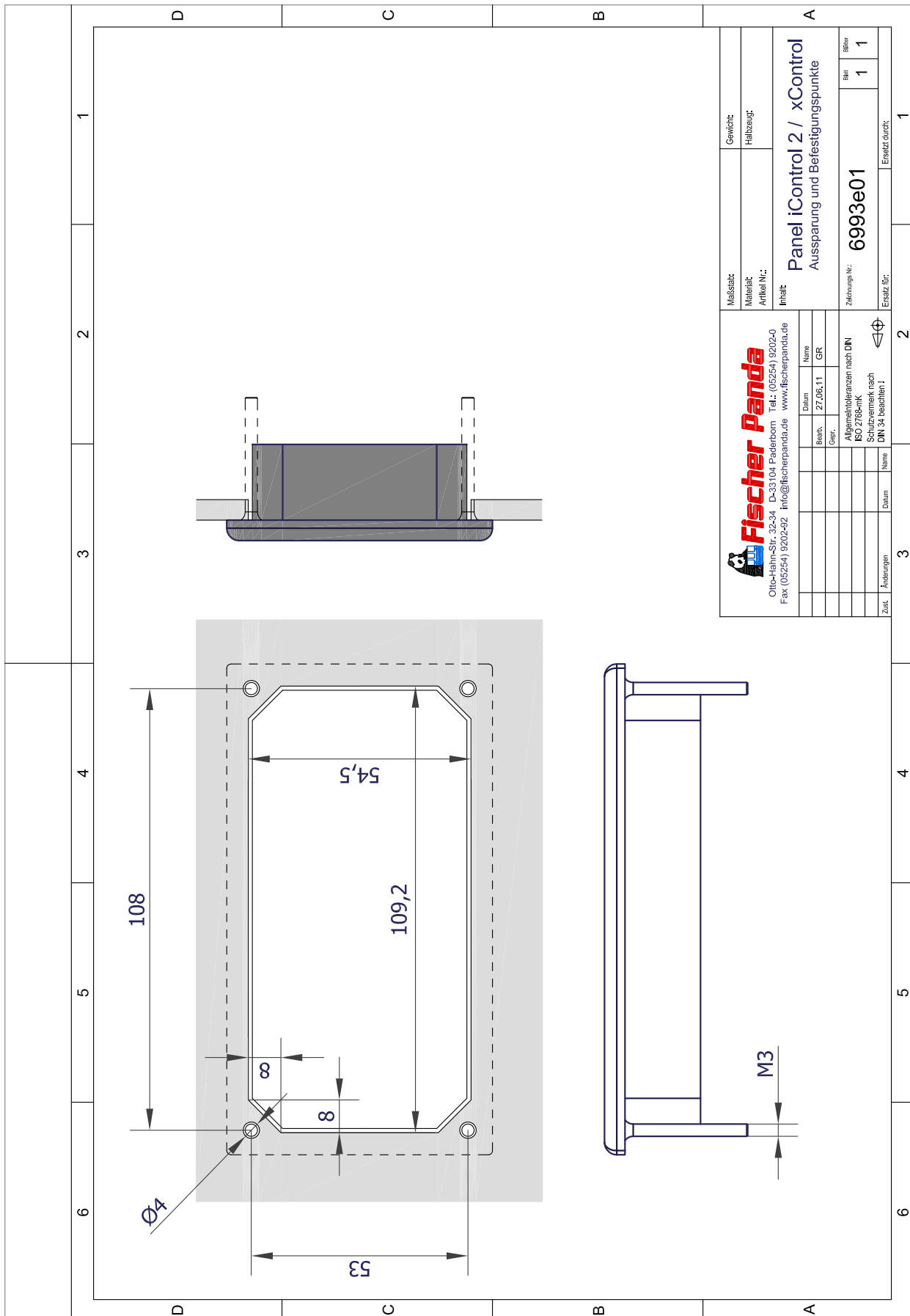
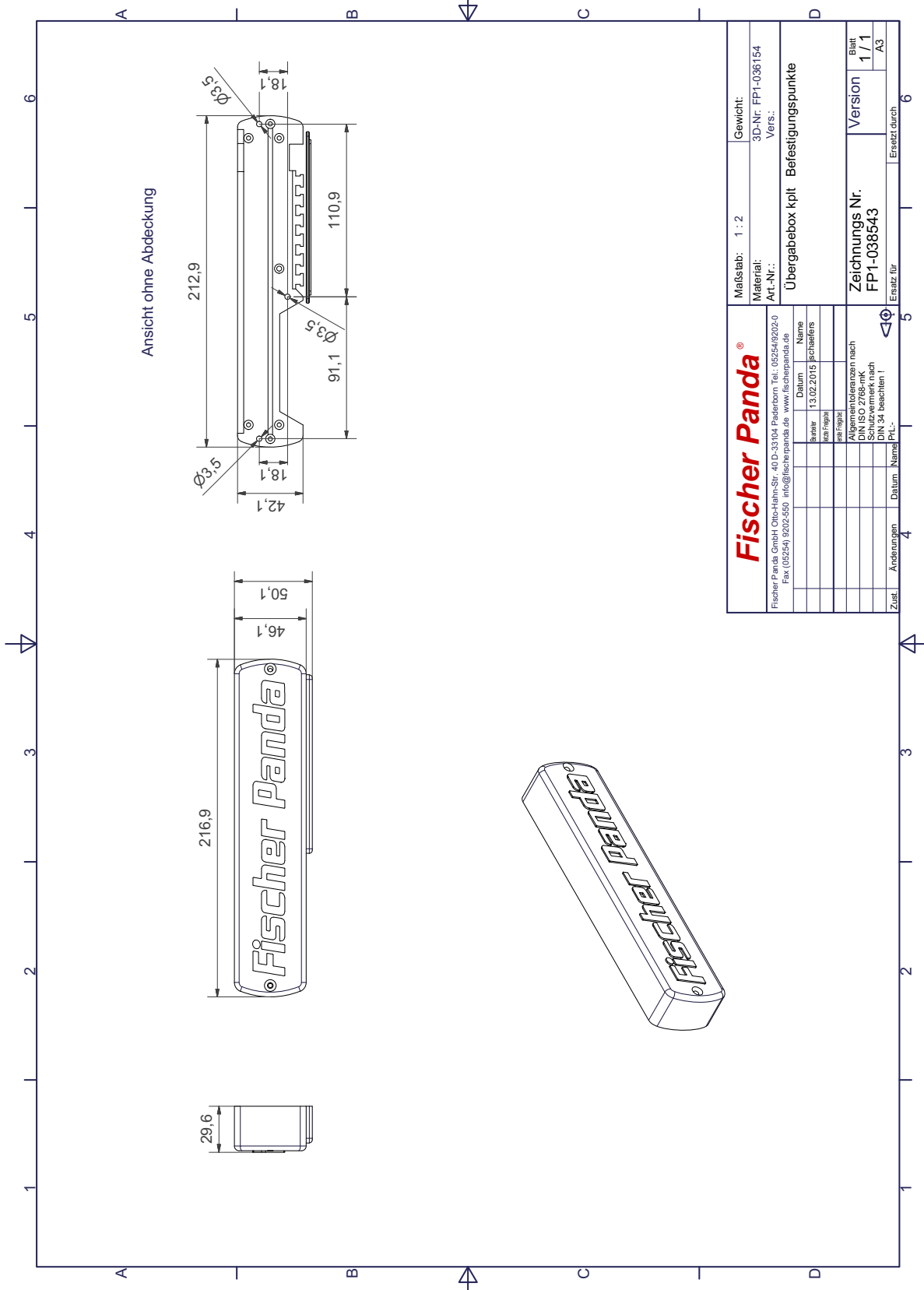




Fig. 11.2.3-3: CB-G





Leere Seite / Intentionally blank