

TECHNICAL DATA SHEET

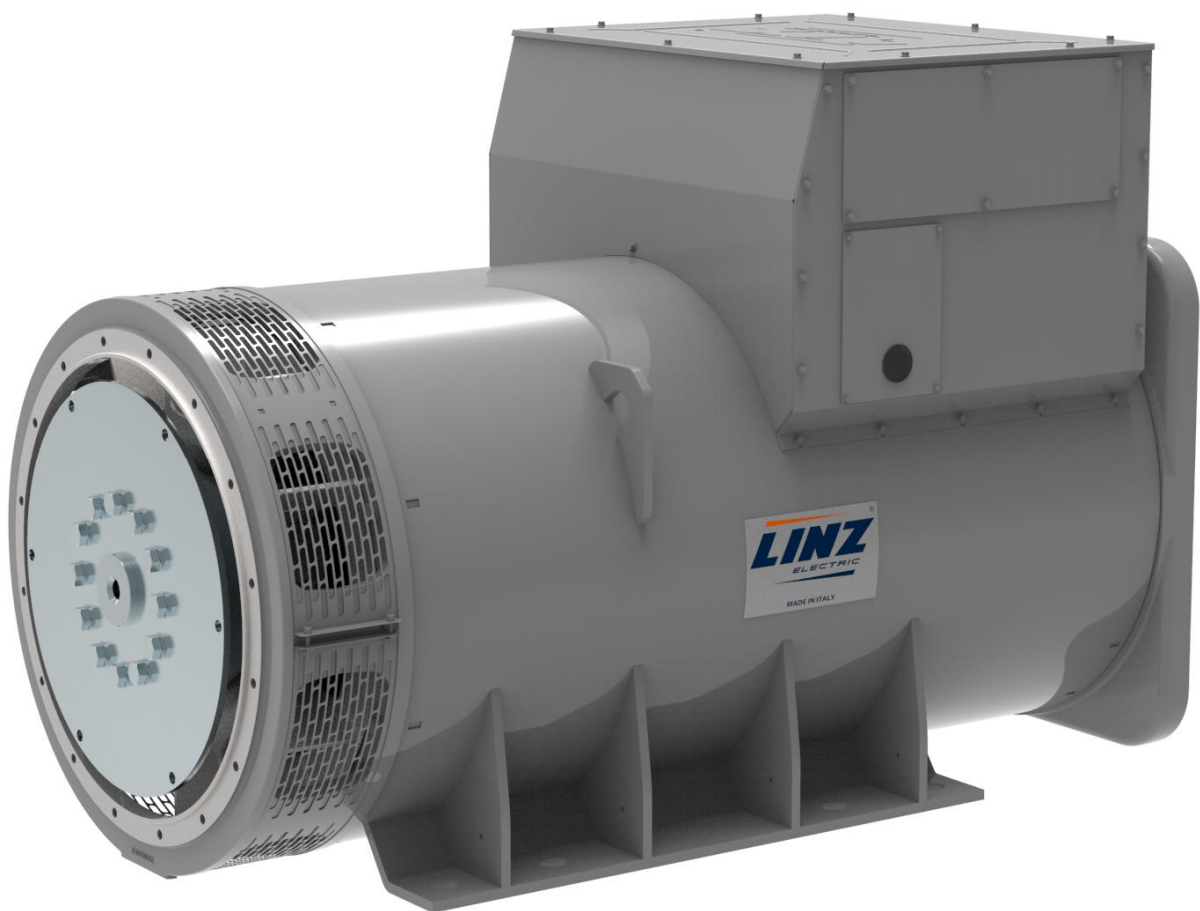

ALTERNATOR PRO40L E/4

Three-Phase brushless synchronous alternator with AVR - 4 poles

PRO40L E/4

COMMON DATA

Rated Power at 50Hz	kVA	1500
Rated Power at 60Hz	kVA	1800
Rated Power Factor		0,8
Nominal Temperature	°C	40
Control System		self-excited
Execution		brushless
Regulation Type		AVR
Insulation Class		H
Protection		IP23
Maximum Over speed	rpm	2250
Overload		110% of rated power for one hour in a cycle of 6 hours
Air Flow Requirement	m ³ /min	105 at 50Hz 120 at 60Hz
R.F.I. Suppression		Standard EN55011

REGULATION DATA

AVR	HVR30
Sensing	three-phase
Voltage Regulation	±1%
Sustained Short Circuit	> 300% of rated current

WINDING DATA

Stator Winding	Double layer with auxiliary winding	
Rotor Winding	with damping cage	
Winding Pitch	2/3	
Number of Leads of Stator	6*	
Stator Winding Resistance	Ω	0,005 at 20°C
Rotor Winding Resistance	Ω	1,16 at 20°C
Exciter Stator Resistance	Ω	13,3 at 20°C
Exciter Rotor Resistance	Ω	0,051 at 20°C
THD at full load	<3%	
THD at no load	<3%	
Excitation at no load	A _{dc}	0,59
Excitation at full load	A _{dc}	2,50

Note (*): 230/400V - 460/800V 50Hz
277/480V - 554/960V 60Hz

STANDARD

References	EN60034-1 ISO8528-3 EN55011
------------	-----------------------------

PRO40L E/4

ELECTRICAL DATA

Frequency		50Hz - 1500rpm				60Hz - 1800rpm			
Voltage Series Star	V	380/220	400/230	415/240	440/254	415/240	440/254	460/266	480/277
Rated Power in Class H (125°C/40°C)	kVA	1500	1500	1500	1400	1650	1750	1800	1800
	kW	1200	1200	1200	1120	1320	1400	1440	1440
Rated Power in Class F (105°C/40°C)	kVA	1370	1370	1370	1250	1500	1600	1650	1650
	kW	1096	1096	1096	1000	1200	1280	1320	1320
Rated Power Standby (150°C/40°C)	kVA	1600	1600	1600	1450	1750	1860	1920	1920
	kW	1280	1280	1280	1160	1400	1488	1536	1536
Rated Power Standby (163°C/27°C)	kVA	1650	1650	1650	1500	1800	1900	1980	1980
	kW	1320	1320	1320	1200	1440	1520	1584	1584

EFFICIENCY IN CL. H

4/4	96,3%							96,9%
3/4	96,6%							97,1%
2/4	95,5%							96,2%
1/4	92,2%							93,4%

REACTANCES AND TIME CONSTANTS

pcc		0,32							
X _d - dir. axis synchronous		244%	220%	204%	170%	270%	255%	240%	220%
X' _d - dir. axis transient		31,0%	28,0%	26,0%	21,6%	34,3%	32,4%	30,5%	28,0%
X'' _d - dir. axis subtransient		13,9%	12,5%	11,6%	9,6%	15,3%	14,5%	13,6%	12,5%
X _q - quad. axis reactance		130%	117%	109%	90%	143%	135%	127%	117%
T' _{do} - O.C. field time constant						2200ms			
T' _d - Transient time constant						264ms			
T'' _d - Sub-transient time constant						24ms			

MECHANICAL DATA

Bearing non drive end				6318-2RS1-C3
Bearing drive end (B3/B14 form)				6324-C3
Weight of generator	in B2	kg		3275
	in B3/B14	kg		3330

PRO40L E/4

MOMENT OF INERZIA

SAE 14	kg·m ²	30,968
SAE 18	kg·m ²	31,361
SAE 21	kg·m ²	32,011
B3/B14	kg·m ²	29,944

DERATING CURVES

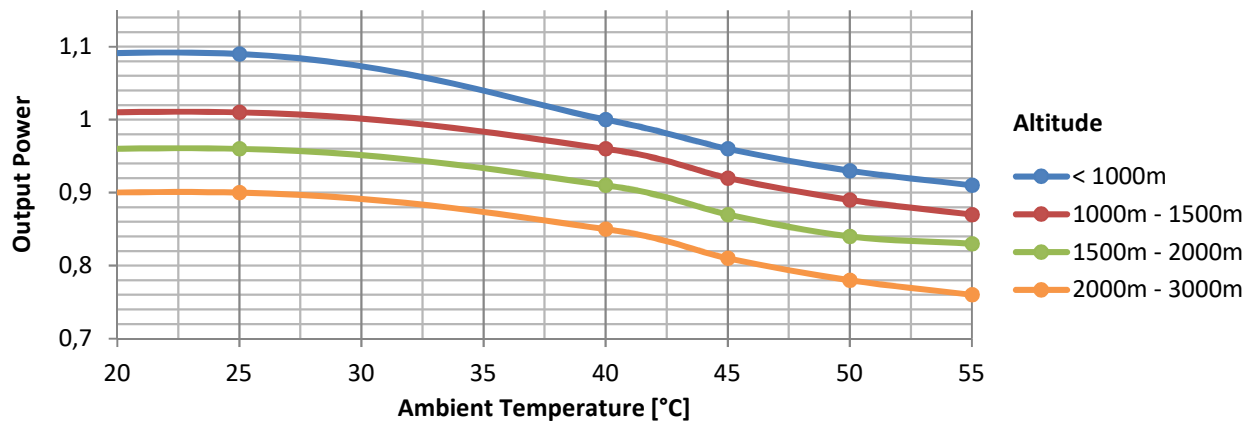

WIRING DIAGRAM

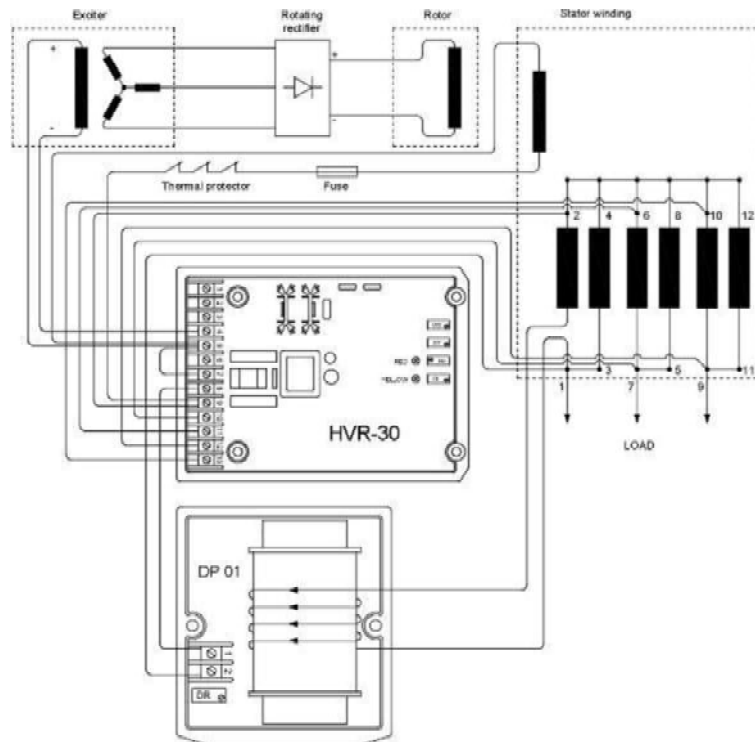

PRO40L E/4

TRANSIENT VOLTAGE VARIATION 50Hz

Transient Voltage Variation @ 50Hz

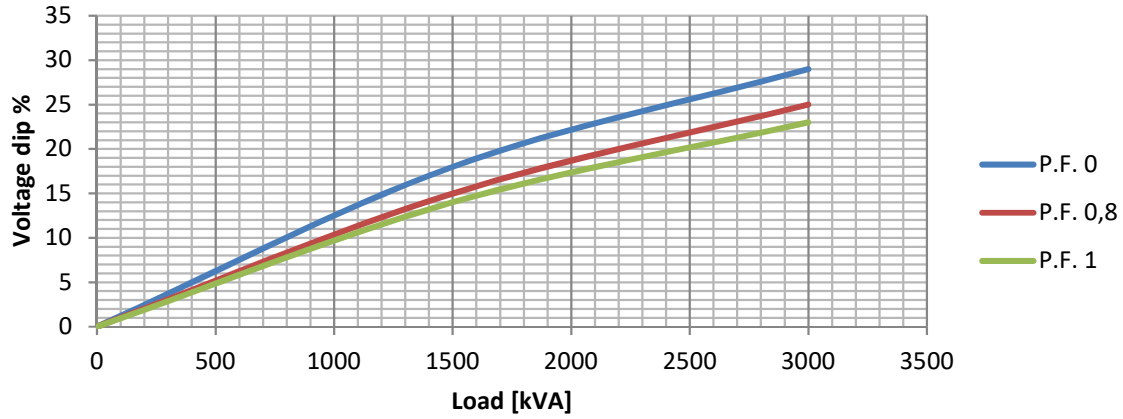

TRANSIENT VOLTAGE VARIATION 60Hz

Transient Voltage Variation @ 60Hz

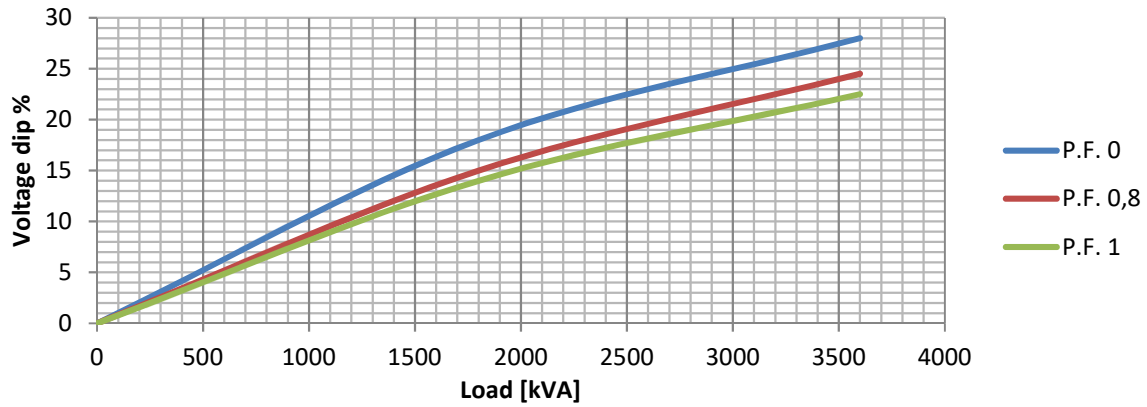

PRO40L E/4

EFFICIENCY 50Hz

Efficiency Curves @ 50Hz

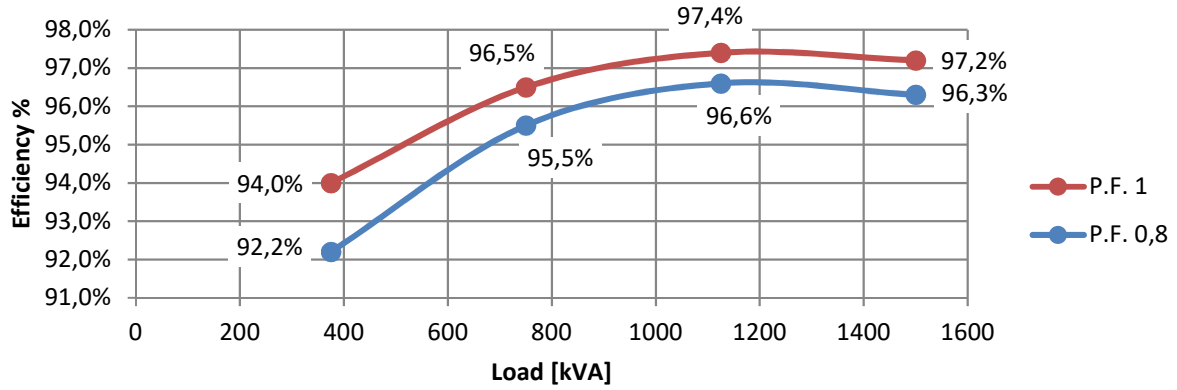

EFFICIENCY 60Hz

Efficiency Curves @ 60Hz

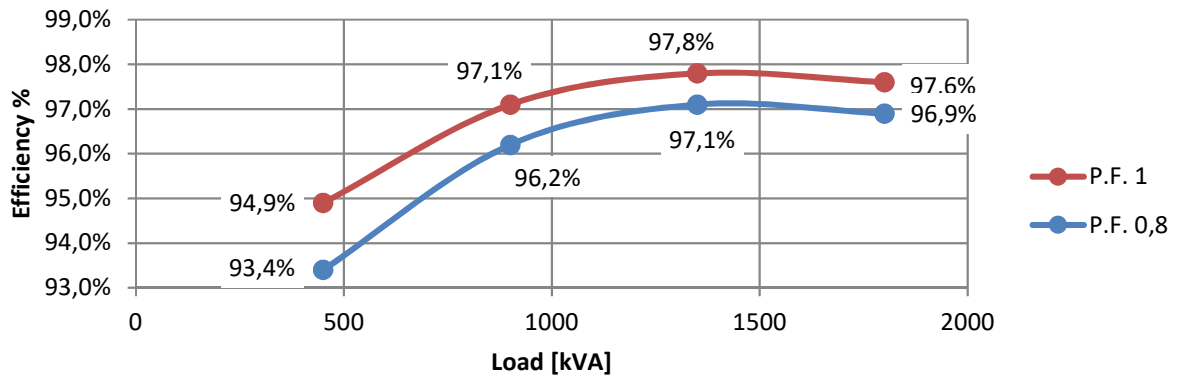

PRO40L E/4

FORMA - FORM B3/B14

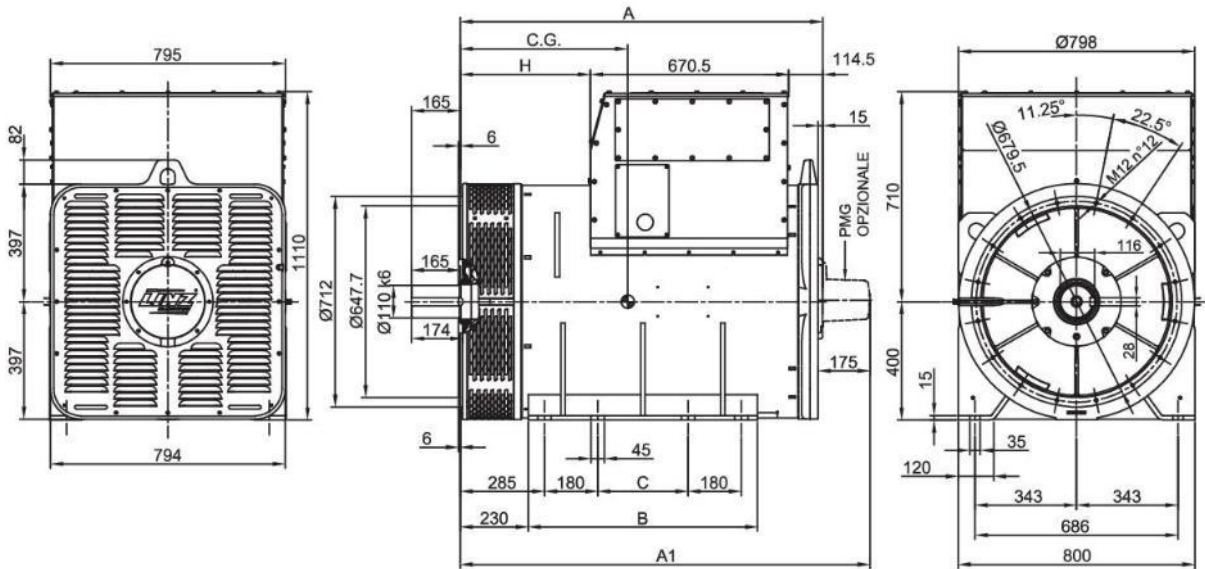

FORMA - FORM SAE

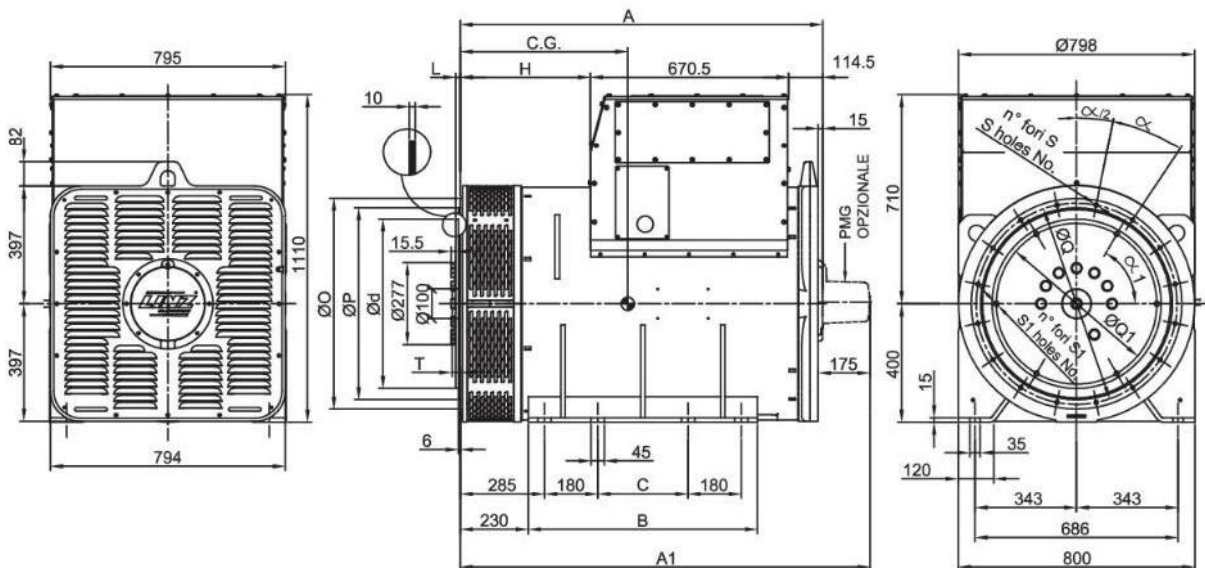

FORMA - FORM	A	H	A1	B	C	
B3/B14	PRO40 S	1225	440	1385	775	305
	PRO40 M	1420	635	1580	775	305
	PRO40 L	1625	840	1785	965	495
SAE	PRO40 S	1225	440	1385	775	305
	PRO40 M	1420	635	1580	775	305
	PRO40 L	1625	840	1785	965	495

TIPO - TYPE	C.G.
PRO40S A/4	597
PRO40S B/4	597
PRO40M C/4	648
PRO40M D/4	693
PRO40L E/4	795

SAE N.	FLANGIE - FLANGES - BRIDAS					
	ØO	ØP	ØQ	n. fori holes No.	S	α
OO	883	787.4	850.9	16	14	22.5°
O	710	647.7	679.5	16	14	22.5°

SAE N.	GIUNTI A DISCO - COUPLING DISCS - JUNTAS A DISCOS						
	L	Ød	ØQ1	n. fori holes No.	S1	α1	T
14	25.4	466.72	438.15	8	14	45°	2
18	15.7	571.5	542.92	6	17	60°	12
21	0	673.1	641.35	12	17	30°	28